

8.00pm  
igus.de/24

Ordering and deliveries weekdays from 8.00 am-8.00 pm,  
Saturday from 8.00 am -12.00. No minimum order  
quantities, no surcharges. Prompt delivery.  
www.igus.de Phone +49-2203-9649-0 Fax -222

Online shopping - 24h! www.igus.de/24



igus.de/e.chain.systems/2.2008.catalog

e.chain®.systems®/2.2008/plastics.for.longer.life®/...  
igus.de/...

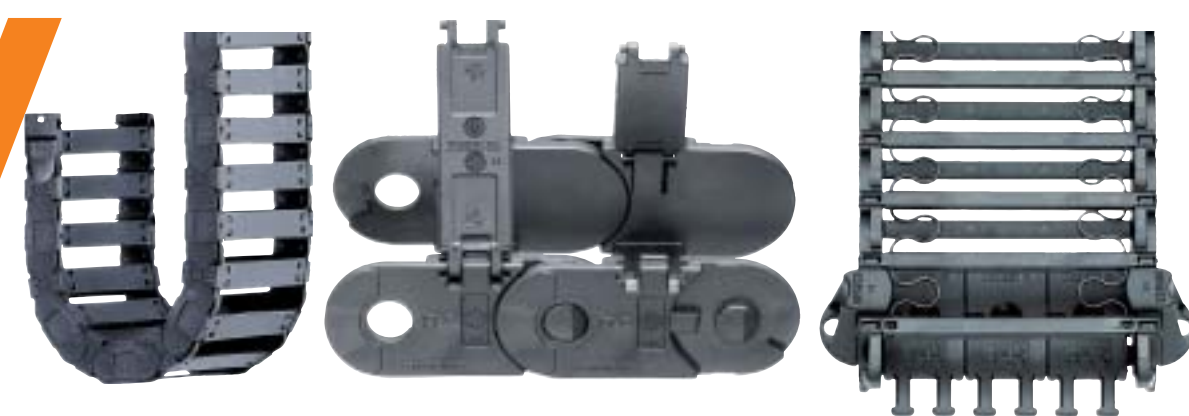

9001.2000  
de/ready

Certified according to DIN ISO 9001:2000

Ask for fully harnessed and preassembled  
Ready-Chains® - increase your cash-flow  
and profit immediately. www.readychain.de

igus.de/...

igus® GmbH Spicher Str. 1a 51147 D-Cologne  
Phone. +49-2203-9649-0 Fax +49-2203-9649-222  
info@igus.de www.igus.de

Subject to technical alterations! MAT0070721.20, Issue 02/2008

e.chain®.  
systems®.  
70.000 products ex stock/readyChain®.harnessed/e.chains®/...

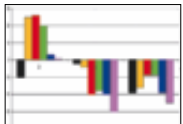
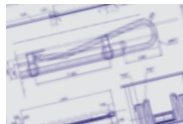



## Designing with E-Chains®

Design and calculation aids,  
applications, diagrams  
▶ from page 1.1

1

## Triflex® R, Triflex®, TwisterChain®

Multi-axis E-Chains® for  
robotic or 3-D movements  
▶ from page 2.1

2

## Easy Chain® System E1 SnapChain

Low-priced, easy to fill  
▶ from page 3.1

3

## Zipper E-Chains® Zipper E-Tubes

Easy opening  
▶ from page 4.1

4

## E2 micro, mini E2/000 medium

micro...mini...medium  
▶ from page 5.1

5

## E2 E-Tubes - Series R and R100

Dirt- and debris protection  
▶ from page 6.1

6

## System E4 - Series E4/00, E4/4, E4/light

The heavy duty all-rounder -  
openable from both sides  
▶ from page 7.1

7

## System E3 System T3 System E6

Extremely low-noise  
and low vibration  
▶ from page 8.1

8

## Guide troughs - solutions for long travels

Long travels  
▶ from page 9.1

9

## Chainfix strain relief

Strain relief  
▶ from page 10.1

10

## PMA cable protection

Cable protection for  
static applications  
▶ from page 11.1

11

## Classic-Series Technical annex

Older products, Terminology  
index, igus® addresses  
▶ from page 12.1

12



# /plastics

# for long

igus® climate chamber - E-Chain® and  
Chainflex® test runs possible at +60°C to -40°



**Plastics for longer life®- make your machines more durable with plastics**

Less maintenance, lower costs, longer life cycles, ex-stock availability - these key principles apply to all igus® products, systems and services. Tried and tested for durability, friction properties and stability. igus® plastics are the technological core of the igus® range. This catalog lists more than 80,000 products available ex stock. We are looking forward to your phone call or e-mail.

**r.life/**

igus® GmbH  
Spicher Straße 1a  
D-51147 Cologne  
Phone +49 (0) 22 03-96 49-0  
Fax +49 (0) 22 03-96 49-222  
info@igus.de  
www.igus.eu

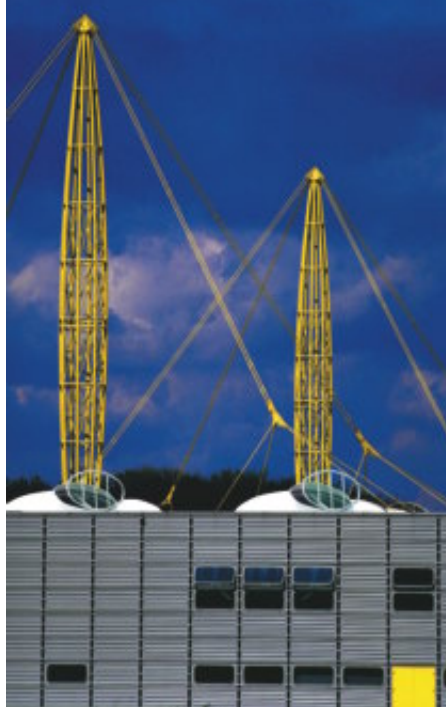

igus® headquarters in Cologne - development, production and marketing from a single location. Certified according to DIN ISO 9001:2000 and for Polymer Bearings additionally according to TS16949

Chain and cable guarantee! Ask for fully harnessed and pre-assembled ReadyChains® - increase your cash-flow and profit immediately.  
[www.readychain.eu](http://www.readychain.eu)

80.000 products from stock.  
No minimum order quantities, no surcharges.

Ordering and deliveries weekdays  
from 8.00 am - 8.00 pm,  
Saturday from 8.00 am - 12.00  
Phone +49 (0) 2203-9649-0 Service "around the clock"

**/ready.chain/  
/80.000  
/20:00h.**



# E-Chains® are lifelines to automated systems from page 1.1

E-Chains® are the umbilical cord of modern machines. They are constantly moving and supply power, data and energy. igus® has been developing, producing and testing polymer E-Chains® since 1971. Our expert knowledge is being refined continuously with the help of our customers to constantly improve our product range.

## Universal applications for igus® E-Chains®

- Multitude of possibilities in terms of movement and length
- To carry sensitive bus, data cables and fibre optics cables and energy sources such as electricity, gas, air and liquids
- To accommodate very high dynamic loads and stringent service life requirements
- Handle very different environments and climates
- Space-saving installation
- High speeds and accelerations can be achieved
- Modular systems allow quick assembly and retrofit

## Save time and money when purchasing and utilising E-Chains®!

- Innovative products that can be assembled quickly
- Rapid delivery time - saves you storage costs
- Large range of products - find the right solution immediately
- System quotes, including made-to-measure production and "turnkey" assembly
- Rapid system design and support with an ever-growing close-knit network of local sales engineers worldwide



The award-winning igus® E-ChainSystems® are certified and tested

Assembled to your exact requirements. Delivered in 1-3 days! ► page 7.1

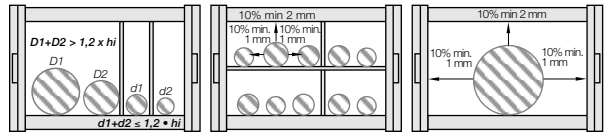
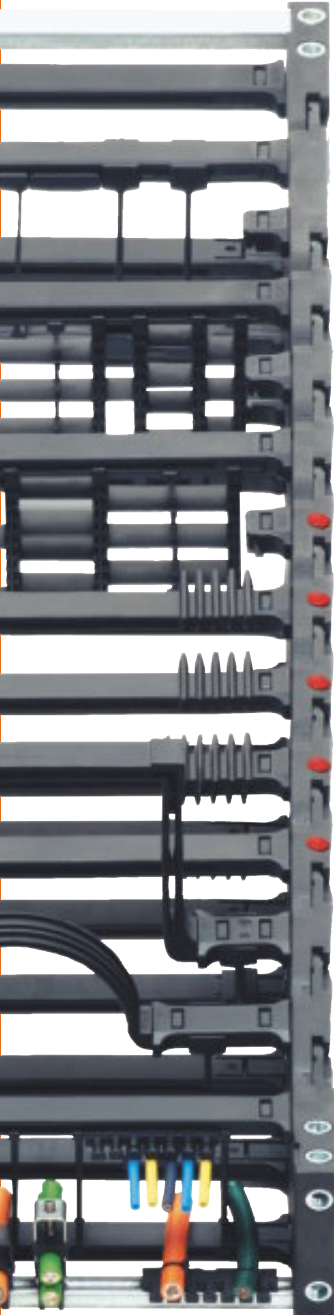

igus® interior separation systems significantly lengthen the life cycle of cables and enable neat layout of E-Chains®. Filling guidelines ► from page 1.29

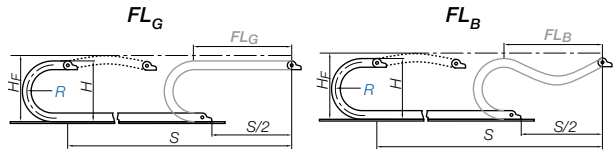

Large unsupported lengths with igus® E-Chains®. Notes, calculations and load diagrams are provided ► from page 1.12

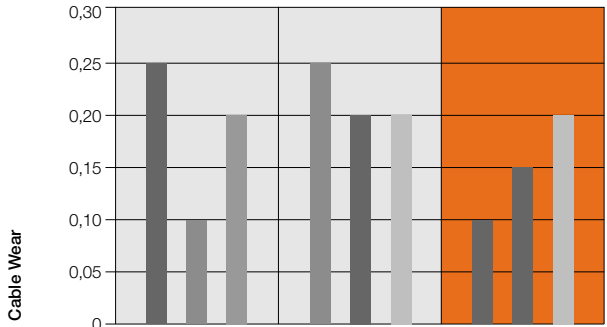

Optimum service life for cables  
Reduce cable wear with igus® polymer separators

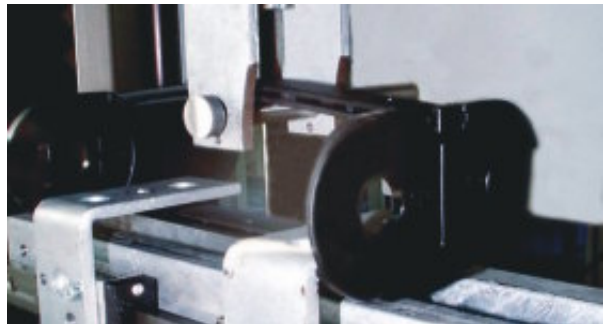

Proven toughness - strength testing in the igus® laboratory

# Triflex<sup>®</sup> R - 3-dimensional E-Chains<sup>®</sup> for robots from page 2.1



iF-Design award  
2004 - Triflex<sup>®</sup> R



Find a video online ►  
[www.igus.de/TriflexR\\_Film](http://www.igus.de/TriflexR_Film)





Triflex® R (R for "round") is the third generation of multi-axis E-Chains®. Design features include:

- Optional fibre rod for spring loading of the Triflex® R
- Approximately  $\pm 10^\circ$  twist per chain link
- High tensile strength of the ball-and-socket joint
- Easy assembly and modification due to single moulded link design. No support elements (steel cables, spring suspensions etc.) are necessary

The Triflex® R product family now comprises more than 100 components meeting all requirements ranging from those of small palleting robots to large welding robots.

Triflex® R with fibre rods and universal assembly kit

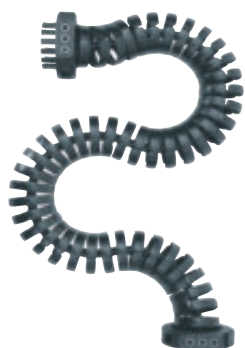

Triflex® R light - save twice on purchasing and installation ► page 2.16

 iF-Design award  
2007 - Triflex® R light



Rotary motion with igus® TwisterChain® ► page 2.56

# Easy Chain® - easy to fill and very price attractive, from page 3.1



Easy Chains® are available with exterior (E) press fit access, as well as interior (Z) access. The assembly time reductions are a primary reason to choose Easy Chains®. Their material, igumid NB, presents more application reasons: Optimal elasticity, UL94-V2 classification and excellent cleanroom qualities. Their one-piece design keeps the Easy Chain® very price-effective.



Machinery of all kinds feature  
igus® Easy Chains®



### Typical industries & applications

- General machinery
- Cleanroom applications
- Electronic apparatus
- Office equipment
- Vending machines
- Packaging machines

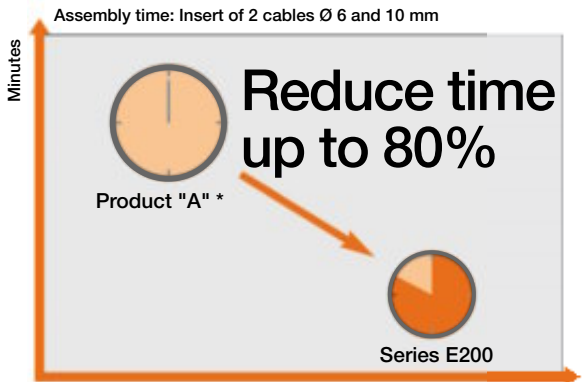

\* We can present you with more Details about this and other tests



Push and snap in



Release side link



Twist and separate



Press in cable



Pull out cable



# Zipper - zip fastening E-Chains® with iF-Design Award from page 4.1

## Lightning-fast opening and closing with Zipper E-Chains® and E-Tubes

"Zipper" E-Chains® convince in practicality and performance. The "Zipper" function makes them a very useful product to reduce assembly time. The small pitch, the tough-elastic zipper-band, and the sturdy link work well in high-acceleration environments. The "Zipper" Series is one of the most popular E-Chain® Series in demanding applications.

### Typical industries & applications

- Pick & place robots
- Semi-conductor machines
- Linear motors, actuators
- Measuring equipment
- Machine tools (Zipper E-Tube)



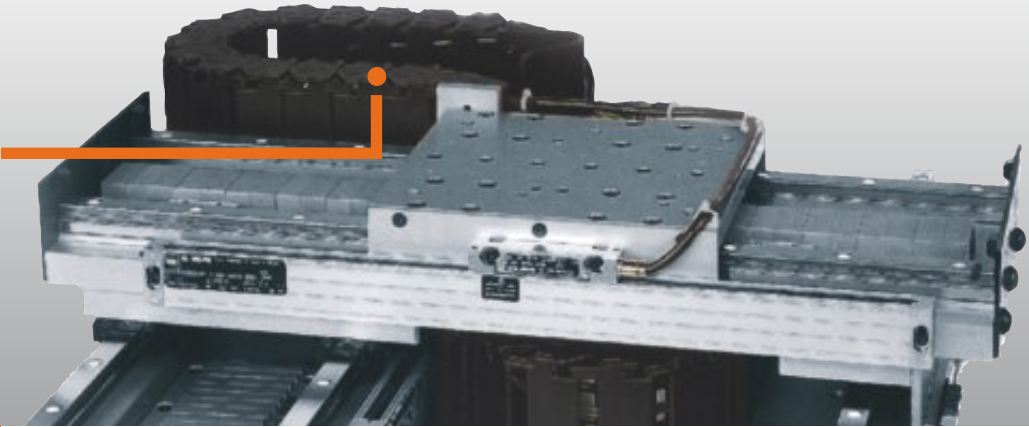

### Lightning fast opening and closing with "Zipper"

- Reduced assembly-time
- Zipper-like design for quick opening and closing of lids
- Zipper lids can be separated and joined at each chain link
- Small pitch for low noise and smooth operation
- High accelerations: 100 m/s<sup>2</sup> and more are possible
- Interior separation possible for larger versions

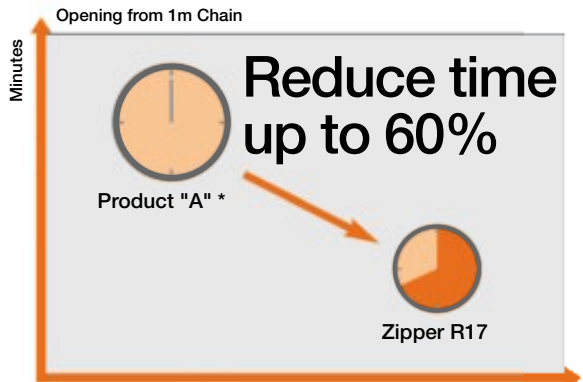

\*We can present you with more Details about this and other tests



Opening the zip - pull the lid at the end of the chain upward and outward



Closing the zip - press the lid carefully downward and inward till it locks



In every chain link, the lids can be detached ...



...and attached



For separation release side link, twist and pull out



iF-Design Award  
for "Zipper-Design"

# E2/000 - E-Chains® with 2 part link design for a wide range of applications, from page 5.78

## E2/000 - the standard

The E2/000 Series is igus® fourth generation in this popular size range. Much past experience went into this New Millenium Series: easy and versatile assembly combined with ruggedness - high stability paired with quieter motion; long cable life and many fixation options. The design is consistent within all E2/000 variations. It is the standard product for machine builders around the world.









Harnessed E2/000 E-Chain® - turnkey solution delivered with cables and sheet metal parts directly to the machine

- Open crossbar left or right quickly with screwdriver or by hand
- Opening mechanism accessible from above - important in tight spaces
- Lightning-fast closing by hand - Secure fit without additional locking devices
- Secure fit of separators and interior separation even when E-Chain® is open
- Excellent mechanical stability and long life due to design and material
- Available as E-Chain® and E-Tube



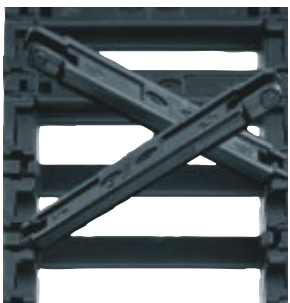

 ESD/ATEX E-Chains® with PTB-certification as well as cleanroom materials with IPA-certification available ► page 1.35



Special snap-open mechanism, choice of snap-open on left or right. Hinged crossbar can be swiveled by more than 180° on both sides



Variant "half" Energy Tube. Fully enclosed in outer radius. Choice of swiveling interior radius to the left or right.



Secure fit of separators and interior separation even when E-Chain® is open.

# E2 E-Tubes -protection in environments with dirt and debris, from page 6.1

## E2 Series R100 and Series R

Since igus® introduced the first openable E-Tubes in the mid-1980's, many additions and improvements have been introduced in the program. igus® E-Tubes work in hot chip areas, in areas of dirt and dust generated by woodworking, steelmills, pulp and paper, textile, agriculture, coal plant and many other hostile environment.

### Typical industries & applications

- General machinery
- Material Handling
- Construction machinery
- Long travel applications
- Semi-conductor
- ESD ATEX versions certified
- Vehicles
- And many more



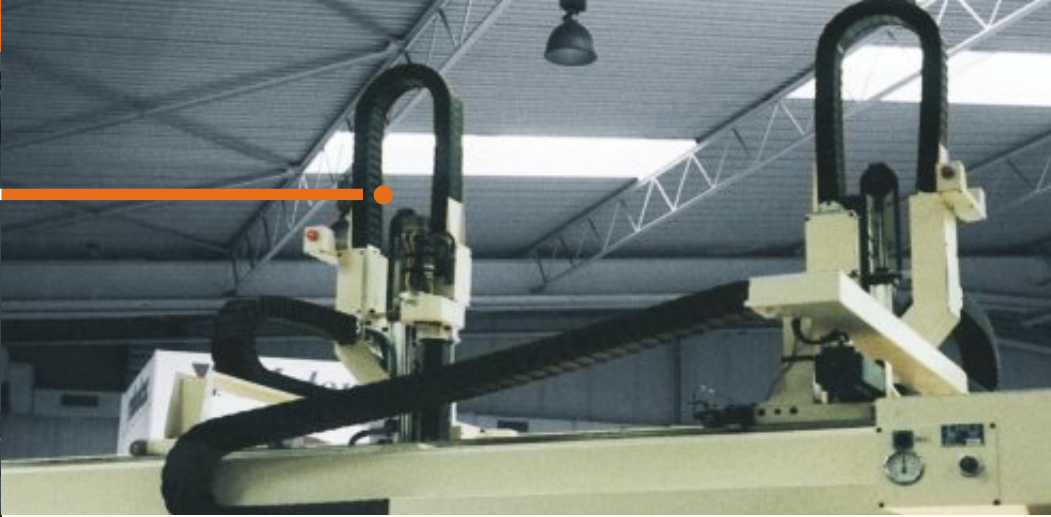

**Standing application R68 E-Tube**

- Very good protection against debris (also hot chips)
- Hinged, snap-open, removable lids along inner/-outer radius reduce assembly time - Series R100
- Lids removable for assembly time reduction - Series R
- Space-efficient with optimized ratio of inner dimension to outer dimension
- Double stop dog for long service life and strong unsupported lengths
- Universal KMA mounting brackets with attachment capability on all sides
- Smooth, chip repellent exterior
- Small pitch for low noise, smooth operation - Series R



**iF-Design Awards - Series R117/118 and Series R68**



E-Tubes with HT-material for hot chips up to 850°C available upon request



**UL94-V2 classifications upon request**



**ESD Classification: Electrically conductive ESD/ATEX version upon request**

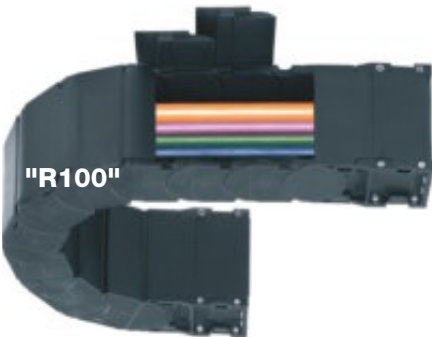

**Series R100 - Cost effective alternative, for applications with low and medium speeds**



**Series R - For higher speeds and smooth running**

**System E4/00 - robust und modular,  
openable from both sides for nearly  
any application, from page 7.6**

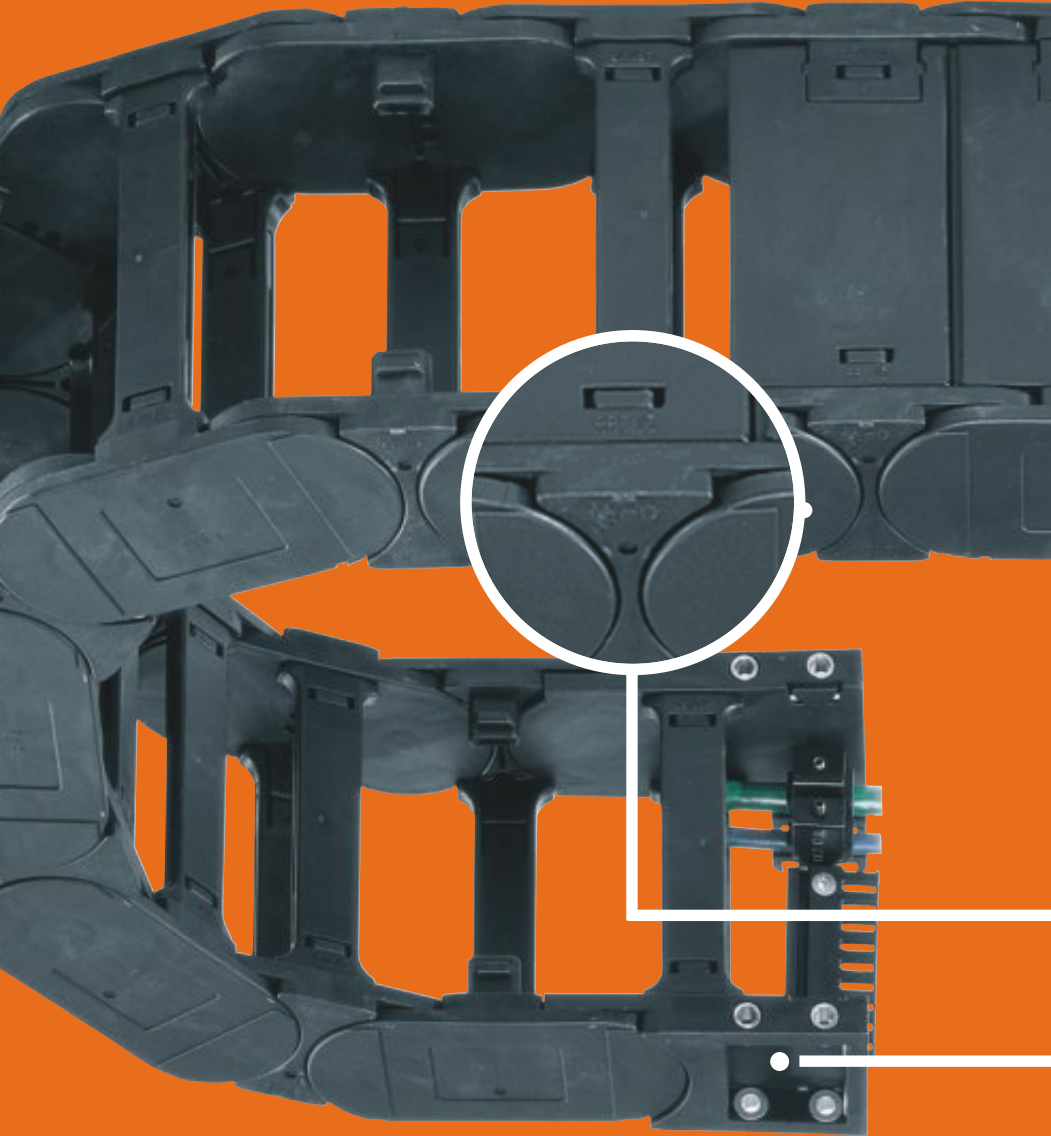



● Crossbars on E-Chains® are removable along both radii. Wide, rounded plastic crossbars are cable friendly. Secure fit due to double lock

● Double, stable stopdog with "brake" for noise-reduction. Glide-pads and wear-pads for a high lifetime of the E-Chain®

● Many accessories for different kinds of applications. Mounting brackets, strain reliefs, interior separators and more

#### Modular E4-construction set

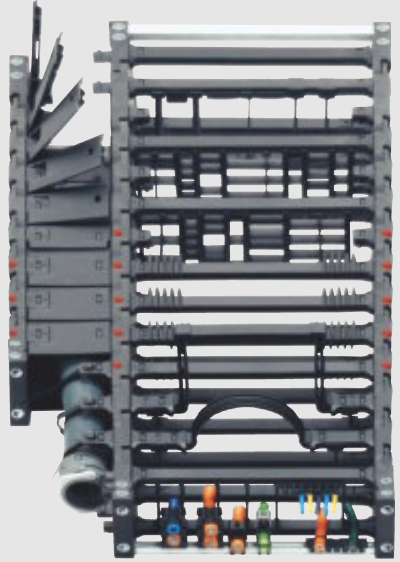

#### Features that apply to E4 E-Chains®:

- Openable from both sides - reduce assembly time
- Maximum robustness and life
- Wide smooth interior surface - cable and hose friendly
- Excellent in all environments
- Basic design proven & reproven for 20 years
- Innovative designs added every year

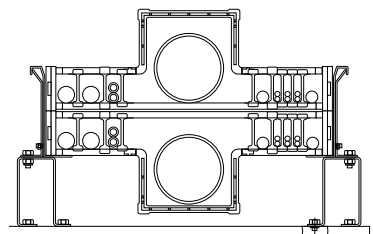

Long travels with huge hoses possible with special extender crossbars



# System E6 - 6-piece E-Chains® - extremely low-noise, minimum vibrations, from page 8.1

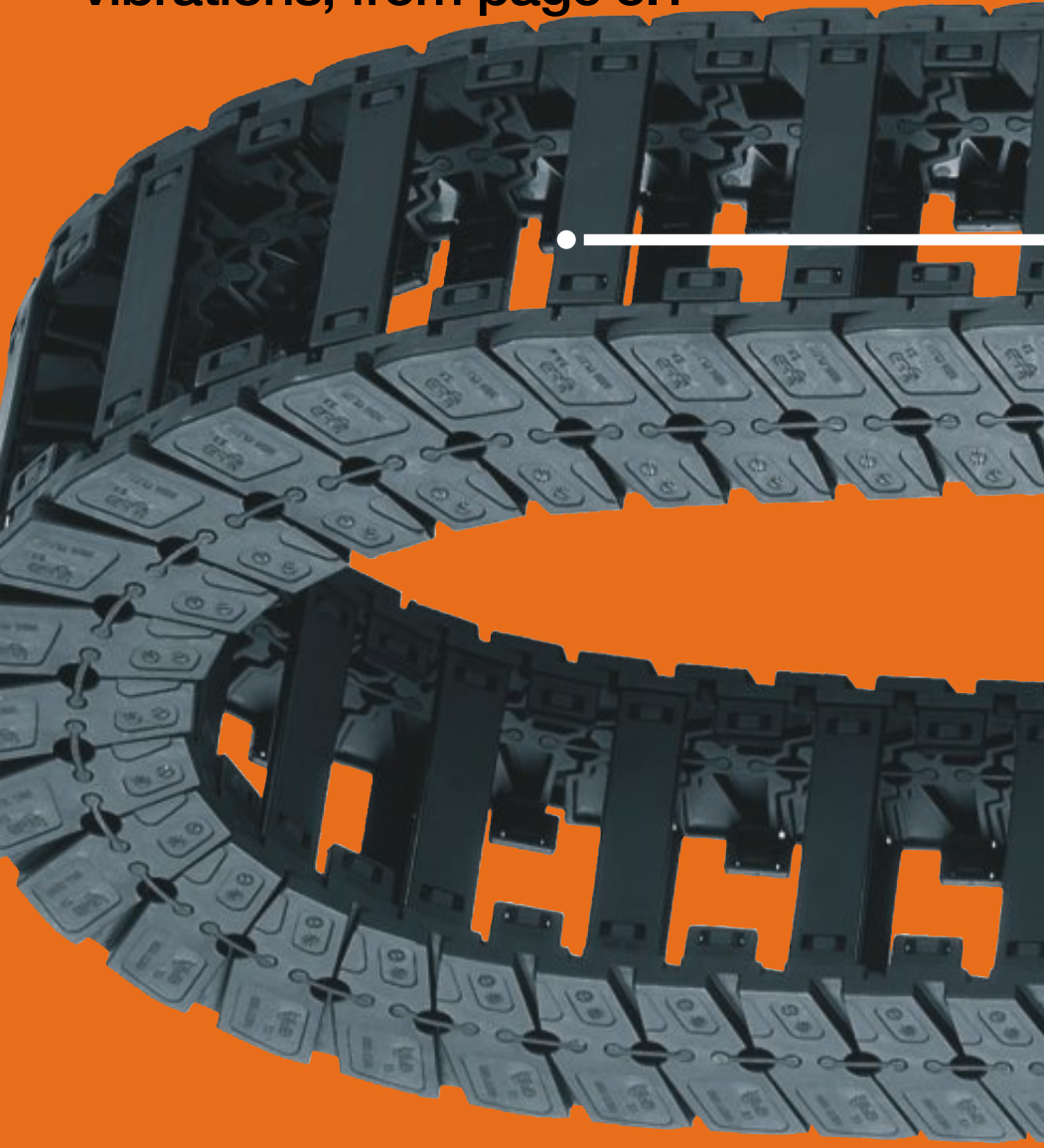

Clean room test acc. to Fraunhofer Institute IPA

- Standard material - ISO Class 1 acc. to US. Fed. Stand. 209E (ISO 14644-1, Class 3)
- Special material "cleanroom" - ISO Class 1 acc. to ISO 14644-1  
Remark: No conforming class acc. to US Norm
- Speed: 0,5 m/s and 2,0 m/s
- Series E6.29.060.150.0

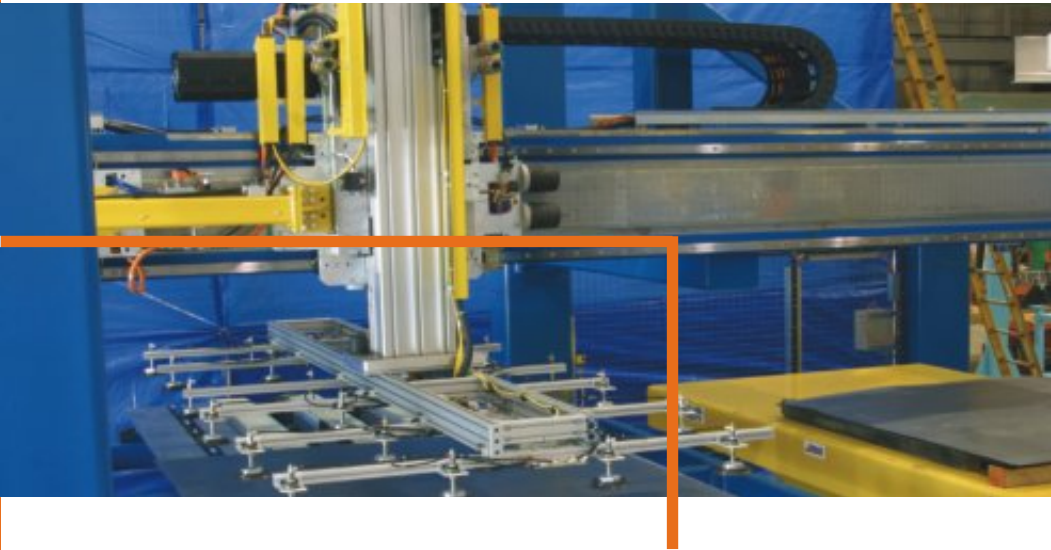

The E6 Series offers numerous advantages in addition to long life cycles. It provides extremely quiet, low-vibration operation. It minimizes the polygon effect which can occur during the rolling motion of an Energy Chain. The ultra-low noise levels have been confirmed in a recent report by the Rheinland Technical Inspection Agency. Our extensive delivery program offers the right chain size for any application; a wide range of interior separators are also available. The same applies to the mounting brackets.

A linear drive provides for highly dynamic feed of PCBs. This system is twice as fast as handling units with a toothed-belt drive; designed to withstand high dynamic loads, the E6 E-Chains® ensure a supply of power, coolant and control data with ultra-low noise and vibration



Life-cycle test of the E6 connector system - more than 220,000,000 strokes have been tested successfully so far

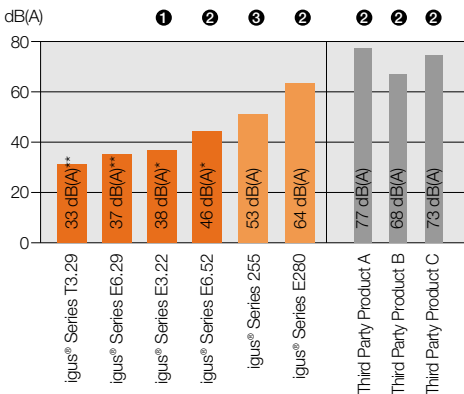

Averaging of the corrected sound pressure levels in dB(A), rounded

- 1 unsupported 1,8 m/s
- 2 unsupported 2,0 m/s
- 3 unsupported 1,5 m/s

\* Measurement by the TÜV Rheinland 46 dB(A) with 10 dB(A) outer noise

\*\* Values permitted in the igus® laboratory according to DIN45635

# Matching accessories for your igus® E-ChainSystem®



Ranging from reliable strain-relief systems for cables through interior separators for proper division of E-Chains® to AUTO-GLIDE crossbars for long travels without guide troughs or special igus® guide troughs for extra-long travels. igus® offers the right solution for every application. The large accessory kit from igus® permits upgrading of your E-Chain® to a high-tech solution. Matched specially with igus® E-Chains®, igus® accessories have been tried and tested in practical applications for many years now.



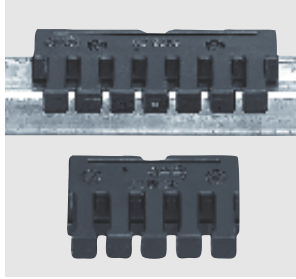

Tie-wrap plates for cable strain relief engage on the C-profile of a KMA mounting bracket. Quicker and more compact assembly ► page 10.9

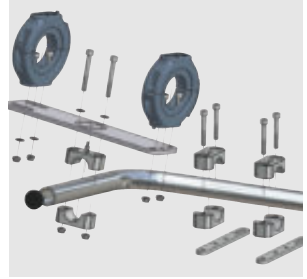

Universal assembly kit for secure and standardized mounting of Triflex® R E-Chain® on robots ► page 2.23



Special connecting elements with strain-relief for the Triflex® R E-Chain® (3D-robot) ► page 2.20



Chainfix cable strain-relief systems. Various strain-relief systems for individual use ► page 10.4

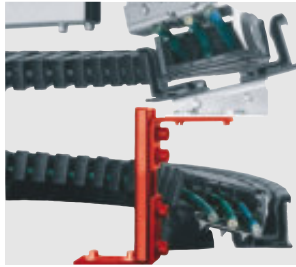

TwisterChain® guide trough systems permit E-Chain® rotation as far as 520° ► page 2.56



PMA protective hoses for predominantly static applications in E-Chains® and for protecting cables ► page 11.1



Find a video online ►  
[www.igus.de/SALU\\_Film](http://www.igus.de/SALU_Film)

Super-aluminium guide trough. The igus® standard aluminium guide trough in two designs - lightning fast assembly ► page 9.1

# Special solutions: Ready-to-install, self-guiding, electronic monitoring

Micro Flizz® - ready-to-install guide-rail ► page 9.86

igus® MicroFlizz® is a sealed, self-contained energy guide system. The component parts of the system comprise: an aluminum guide, igus® E-Chain®, guide carriage, sealing washers, Chainflex® cables or media hoses. The seals against dirt and pollution, thereby lengthening service life and saving costs.

- Protection for cables and E-Chain® against debris dirt
- Very quiet

- Suits high speeds
- Universal attachment options through 3 T-grooves
- E-Chain® to tow arm attachment through roller cart, gliding element or locking
- Opposed E-Chains® possible for double load capacity or 2 independent travels
- Multiple parallel systems possible
- Application examples: Storage/Retrieval Systems, sliding gates, etc.



Find a video online ►  
[www.igus.de/MF\\_Film](http://www.igus.de/MF_Film)



iF-Design award  
2006 - Micro Flizz®





## AUTO-GLIDE - Long travels without guide troughs ► page 9.72

Long travels always place quite exceptional stresses on an E-ChainSystem®. In most cases, guidance is provided for by means of a guide trough. For applications where a guide trough is not desirable.

igus® 1995 developed the AUTO-GLIDE system. Possible uses:

- In the case of travels up to 100 m
- In the case of travel speeds up to 1.5 m/s



Find a video online ►  
[www.igus.de/AG\\_Film](http://www.igus.de/AG_Film)

## Remote condition monitoring system for E-ChainSystems® in large scale applications

Used in applications on cranes, material handling systems, power plants, chemical plants, etc., where safe and reliable function is of the essence and where unplanned down time means high costs. PPDS online monitoring system monitors the push/pull forces of the E-Chain® thereby improving operational safety. Push-/pull force data is individually pre-determined value. If failures occur, instant alert messages are automatically generated, through e-mail or SMS, and can immediately be analysed from any remote location. Saved data can be analysed retro-actively for a period of up to 3 months.



Long travels with electronics...



...Push/Pull-force monitoring with the igus® PPDS System

## Easy PPDS - monitoring long travels

Sensitive equipment that requires an automatic shutdown function, can be equipped with this cost-effective emergency stop system. Simple comparison of nominal/actual data.

- Max. forces are programmed, system shuts down when those values are exceeded
- Individually programmable, cost-effective solution
- Data memory for up to 40.000 measuring readings

More details upon request: ►  
phone. +49- (0) 22 03-96 49-800

Easy PPDS-continuous real force measurement and limit comparison



# LeviChain - magnetic E-ChainSystem® - it "floats" from page 9.88

Virtually contactless energy supply for long travels - low noise, low wear, safe and available!

The principle of magnetic "floating" is based on the attractive forces of a magnetic field, centering on all sides. Due to this "centering", the E-Chain® moves nearly contactless with very low friction and wear characteristics and minimal wear.

Modular igus® E-Chain® different widths and bending radii, "magnet free"

Support elements

Contactless guidance of upper run and (optional) lower run

Magnet modules

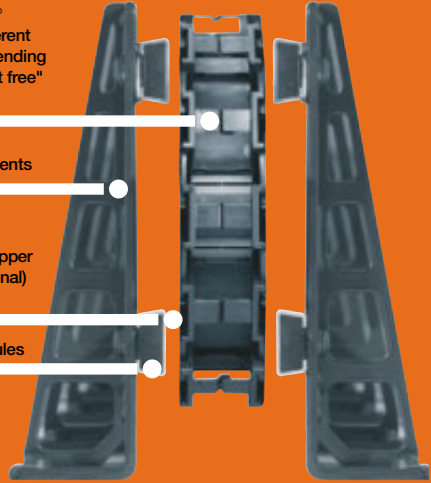

Find a video online ►  
[www.igus.de/LV\\_Film](http://www.igus.de/LV_Film)



Clean room test acc. to Fraunhofer Institute IPA

- ISO Class 100 acc. to US. Fed. Stand. 209E (ISO 14644-1, Class 5)
- Speed: 0,5 m/s, 1,0 m/s and 2,0 m/s

Tested was a cleanroom-optimized version

Unsupported configuration, even for very long travels. Upper and lower run will never come in contact with each other. The lower run can be "floating" as well (optional).

# Serie P4 - shaped rollers chain for very long travels, 10m/s, low noise

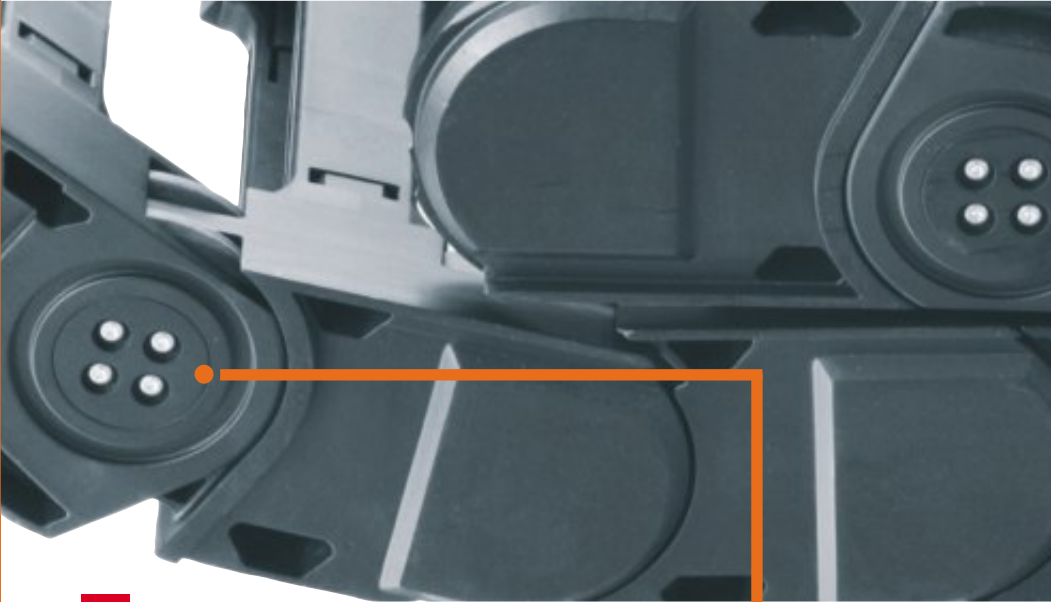

iF-Design  
award 2007

igus® Rol E-Chain® has been used in over 1,000 installations worldwide. Some applications such as cranes have ever-increasing demands for length of travel, fill weight and speed. New Rol E-Chain® P4 with shaped rollers meets these demands through these design features:

- Smooth, low noise operation through identical pitch length for links with and without rollers
- Grooved roller running on continuous, plain surface
- Large glide area for rollers
- Rollers are integrated in to side link
- Heavy duty version for high fill weights and push/pull forces

## Typical industries & applications

Cranes ● Warehousing ● Equipment manufacturing ● Gantry robots ● Material handling



Smooth running due to same pitch of the roller-links



AUTO-GLIDE bars care for a safe guiding on long travel applications

AUTO-GLIDE ► page 9.68

# New for the E2-System: Guidelok - no swinging sideways of the E-Chain®!

For vertical energy supplies up to 80m height

## The problem:

Suspended E-Chains® can swing sideways due to transverse acceleration.

## The solution:

New "Guidelok" system. E-Chain® stays on track even with high transverse acceleration! When the chain moves over the control button ❶ the fixing button ❷ is moved, the lower run of the E-Chain® held in place, preventing it swinging out. For elevators, racking units, material handling equipment.

## Typical industries & applications

● Automated storage/retrieval systems ● Lifts ● Revolving storage systems ● Diagonal lifts ● All vertical applications

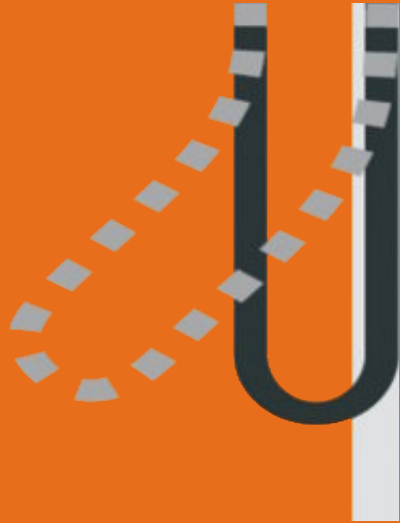

Find a video online ▶

[www.igus.de/GuideLok\\_Film](http://www.igus.de/GuideLok_Film)



### No more outward swinging - "Guidelok"

Vertical E-Chain® applications up to 80 metres high are increasing all the time, all at high speeds and accelerations. In next to no time, the E-Chain® can swing outwards and sideways e.g. towards the shelving. This can lead to damage to the echain or surrounding structures. igus® has now developed a system called "Guidelok" where the E-Chain® always remains safely on track even with mast or tower heights of up to 80 metres.

The new "Guidelok" system is for vertical E-Chain® applications with large lifting heights in racking units, elevators, inclined elevators and material handling equipment. Compact and easy to install, also as a retrofit system, it makes energy and data transfer safe in goods warehouses, deep freeze storage, crane systems or even in wind power plants. Whereas previously the suspended E-Chain® was routed in an enclosed groove system or vertically guided using other similarly completely enclosed solutions, there is no longer any need for expensive casing of any kind. Thanks to the clever design, the E-Chain® traps itself again in the new "Guidelok" system.

### Catching the E-Chain®

The E-Chain® is suspended in a stainless steel or galvanised steel guide channel. Two rocker arms - push button and catch button - in the groove, which are automatically triggered by the radius, fix the chain in place.

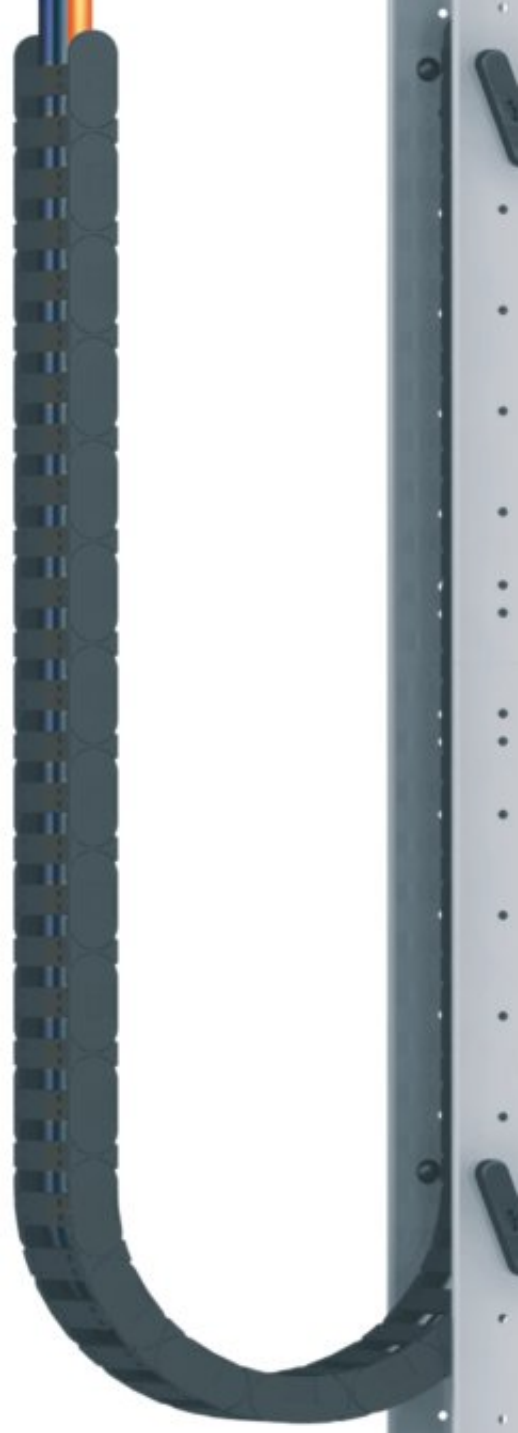

Application example: Hanging application in a high-bay storage ► page 1.20



# ReadyChain<sup>®</sup> harnessed E-Chain-Systems<sup>®</sup> are listed from page 1.41

## **Eliminate storage costs for cables, E-Chains<sup>®</sup> and plugs**

Our short and guaranteed delivery periods enable you to dispense entirely with a storage of ultra-flexible cables, related plugs and add-ons.

## **Shorten turnaround times by half**

Thanks to sophisticated logistics, igus<sup>®</sup> is able to supply complete systems within 10 days of the guaranteed deadline to almost any part of the world.

## **Flexible response to order fluctuations**

With ReadyChains<sup>®</sup>, you remain prepared for all phases of an economic cycle. Fluctuations in your capacity utilization are absorbed by our product logistics.

## **Reduce the number of subcontractors and related orders by 75%**

One order, one invoice, one delivery, one partner. You no longer need to procure countless individual components from a host of subcontractors; we know how to acquire the right parts quickly and economically.

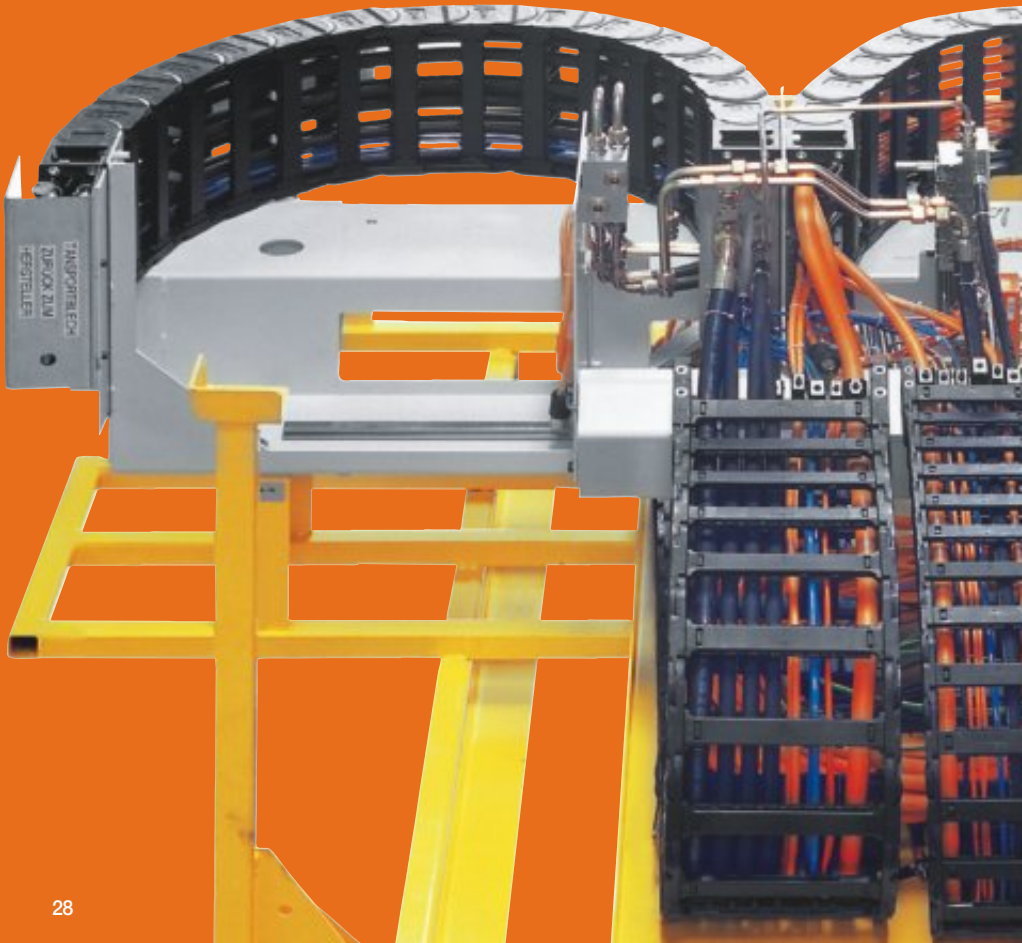

### Minimize your machine downtimes

External purchases of numerous individual components not only make your systems more susceptible to malfunction but also make trouble-shooting more difficult. ReadyChains® provide you with standardized systems. Every system is tested at our facility prior to delivery. igus® is certified according to ISO 9001. [www.ReadyChain.de](http://www.ReadyChain.de)



Find a video online ▶  
[www.igus.de/RC\\_Film](http://www.igus.de/RC_Film)

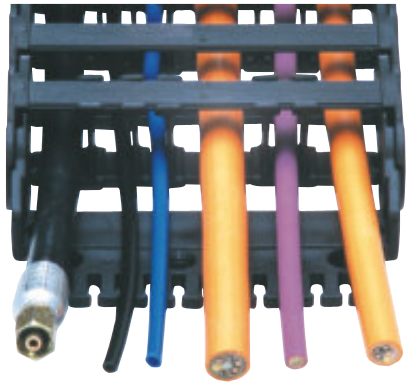
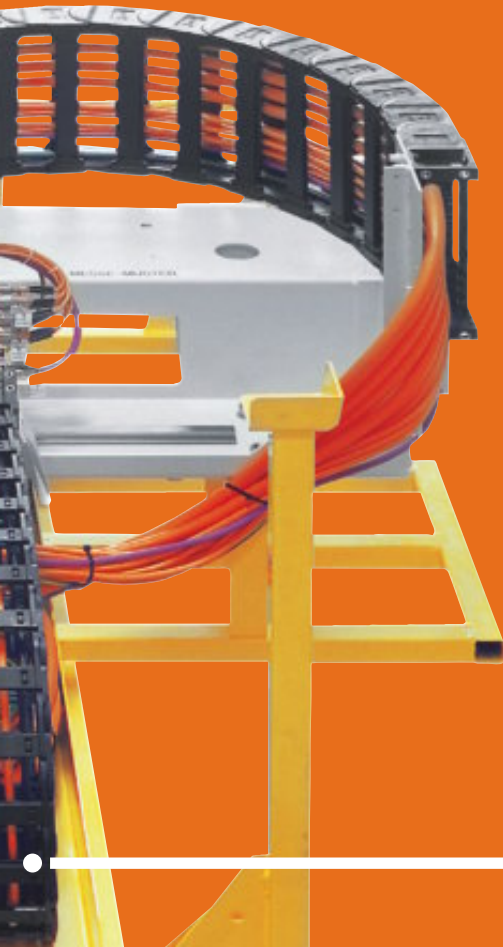

### "Basic" ReadyChain®

Simple, harnessed E-ChainSystems® including installed cables without plug connections, labelled and tail-lengths according to your specifications.

*Delivery period: 1-3 days*

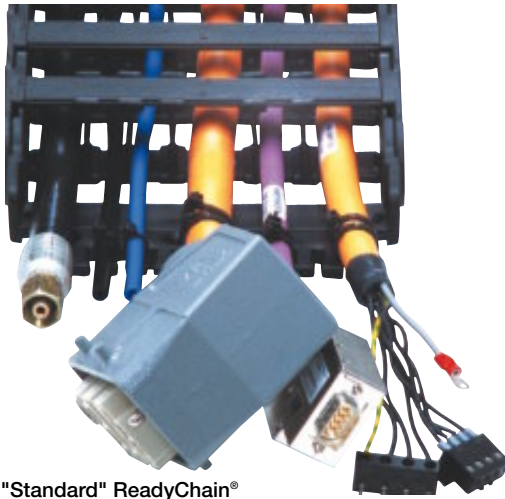

### "Standard" ReadyChain®

Simple, harnessed E-ChainSystems® including installed cables with all plug connections, labelled and tail-lengths according to your specifications.

*Delivery period: 3-7 days*

### Left: "Premium" ReadyChain®

A harnessed E-ChainSystem® with cables of all kinds, as well as plugs, connectors, tail-lengths and components according to your specifications. Special shafts and plain bearings machined according to your specifications.

*Delivery period: 3-10 days*

# Chainflex® lasts. Or your money back.

Your production processes must remain trouble-free, and that means your energy supply systems too. This requires fully reliable operation by all relevant components, including cables. igus® was the first company to develop complete E-ChainSystems®. Chainflex® cables and E-Chains® are offered together from a single source with a system guarantee depending on the application involved. Design principles based on knowledge of cables and exhaustive test Series since 1989 prevent machine downtimes at plants all over the world today.

## 7 rules for making a good cable

### 1. Strain-relieved core

Empty space arises at the core of the cable depending on the number and cross-section of the conductors. This core space should be filled to the greatest possible extent with a proper rope (not with the usual fillers or dummy wires made of waste material). This reliably braces the surrounding strands and prevents them from sliding into the middle of the cable.

### 2. Strands

Experience has shown that the strand structure should be as flexible as possible. Although very thin individual wires result in very flexible conductors, these are highly susceptible to damage. Extensive test Series have helped to determine which combination of wire diameter, strand pitch and strand direction optimizes bending resistance.

### 3. Core insulation

Insulating materials must be designed so that they do not stick together once inside the cable. Furthermore, the insulation should brace the individual wires of the cable. For this purpose, we use only the best PVC and TPE extruded at high pressure and proven in millions of kilometres of wire forming part of E-Chain® applications.





#### 4. Braids

Braids must have an optimized, short pitch around a stable, strain-resistant core. To co-exist properly with the insulating materials, braids must allow movement over a certain range. Starting from a quantity of 12 cores stranding in bundles should be applied.

#### 5. Inner jacket

A gusset-filling, extruded inner jacket should be used instead of low-cost non-woven fabric, filler or tracer. This permits secure longitudinal routing of the braid. It also prevents the braid from loosening and drifting.

#### 6. Shielding

The shield should generally have a taut structure with an optimized angle of twist about an extruded inner jacket. Loose, open structures or, worse yet, purely circumferential windings notably reduce electromagnetic compatibility and can fail easily as a result of wire breakage. A taut shield braid makes the underlying wire braid more resistant to torsional strain.

#### 7. Outer jacket

An external jacket made of ideal materials can meet a wide range of specifications: From UV resistance through low-temperature flexibility and oil resistance to cost-effectiveness. However, all external jackets should have the following in common: Highly resistant to abrasion without sticking and highly flexible while still supportive. In addition, all external jackets should be extruded at high pressure (gusset-filling).

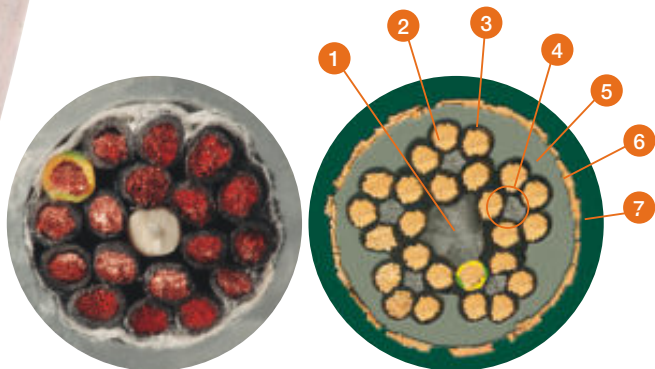

Conventional  
"chain suitable" cable

igus® Chainflex® -  
special cable

Order separate Catalog online at:

► [www.chainflex.eu](http://www.chainflex.eu) or phone. +49- (0) 22 03-96 49-0



# Solutions with igus® E-ChainSystems®

More exciting examples ► [www.igus.de/en/EKPraxis](http://www.igus.de/en/EKPraxis)

igus® E-ChainSystems® guide and protect moving cables and hoses on automated equipment. They can be used in a wide variety of applications. On the next pages are some examples. **Malaysian ship unloading crane** - One of the longest igus®

travels with 441,3m for two ship unloaders in Malaysia with igus® Series 5050R. The integrated rolls reduce shearing and tractive loads by more than 75%. This is due to better coefficients of friction of the rolls in comparison with the sliding







Unsupported, side-mounted application with Series E4/4 - higher stability due to "undercut-principle"

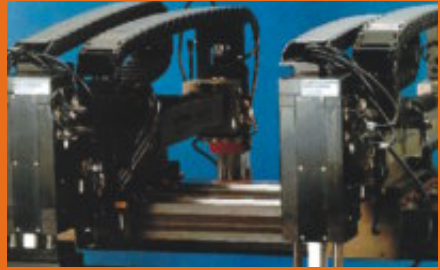

Automatic PC board component insertion unit with igus® Zipper Series 15. Accelerations up to 100 m/s<sup>2</sup>



Drive simulator. High fill weights (60 kg/m) with E4 System



Multi-axis Easy Triflex® on a production line



ReadyChain® under water. Treasure Island, Las Vegas. System E4 and Chainflex® CF9



Energy supply for live transmission at the Olympic Games at -40°C, Series 200



ReadyChain® with combined motions on tooling machines. Turnkey delivered with special parts for your machines



Hanging application with Series 2400 on a storage/retrieval system

# Solutions with igus<sup>®</sup> E-ChainSystems<sup>®</sup>

More exciting examples ► [www.igus.de/en/EKPraxis](http://www.igus.de/en/EKPraxis)



Crash test unit: 22 m/s and 784 m/s<sup>2</sup> acceleration for 36 m travel

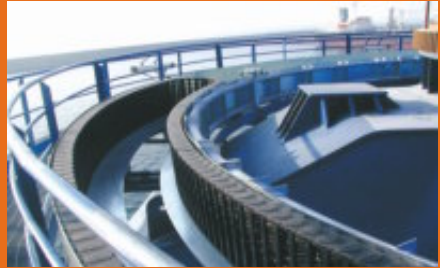

Circular movement with Series E4/4  
- safe energy supply on cranes



The Rol E-Chain<sup>®</sup> E-Chains<sup>®</sup> require  
75 % less drive power (gliding operation)



Complex movements with  
Triflex<sup>®</sup> R, combined movements



Extension links for E2 and E4  
for large conduits up to Ø 250 mm



Cleanroom and Triflex<sup>®</sup> R  
with special color white



Zig-Zag movements, 36 m  
height with E4/4 ReadyChains<sup>®</sup>



igus<sup>®</sup> System E6 - High  
acceleration (8g) and ESD safety



Robots with Triflex® E-Chains®  
Assembly line, Ford Cologne



# Quality from the igus® laboratory: Tested and proven every day.

## igus® test laboratory

Applications involving high cycle counts, speeds and accelerations or demanding environmental conditions require proven systems especially when it comes to E-Chains®, cables, polymer slide bearings and linear systems. igus® regularly conducts tests at its own laboratory under realistic conditions. Every year, we conduct more than 2,000 tests on E-Chains® and cables, and over 5,000 tests on plain bearings. These tests focus

on push/pull forces, friction values, wear rates, drive forces and abrasion under all possible conditions at diverse speeds. Influential factors like soiling, weathering, cold and impact are examined. Tests are also performed on electric cables and hydraulic and pneumatic hoses. Our laboratory is at your disposal. Should we lack data for your application type, we will gladly conduct tests according to your requirements.

Partial view, igus® test-lab:  
More than 80 tests every day with E-Chains® and Chainflex®-cables

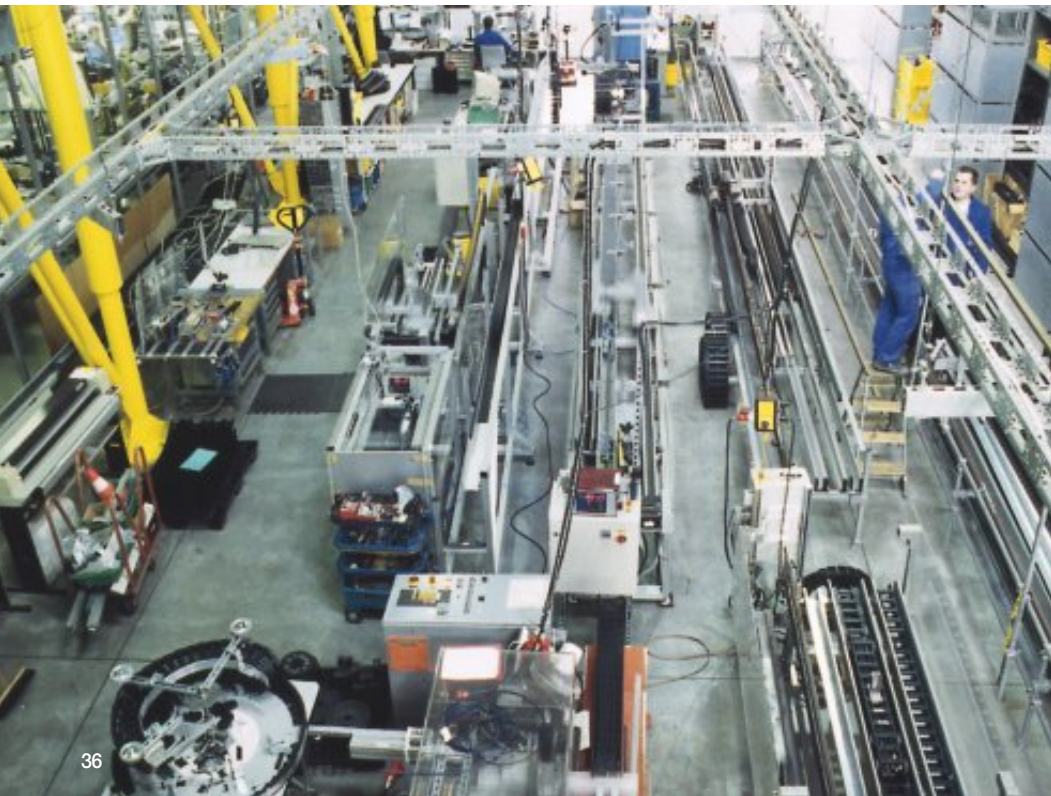

# Global Warranty Certificate

Global warranty for \_\_\_\_\_

We hereby confirm the following warranty for the gear 2 (Manufacturer's production description) of the machine type \_\_\_\_\_.

The system 2 (1) is tested and approved, and all other requirements for the gear 2 (Manufacturer's production description) are met in accordance with the applicable standards. The data on the machine type are the basis for the warranty period.

We reserve the right to withdraw the standard (Manufacturer's) gear 2 in the future.

Other equipment: \_\_\_\_\_



igus® system warranty  
 Every application is different. igus®  
 warranty certificates will be issued  
 for your application individually.  
 Ask for igus® warranty:  
 "chain, cable, guarantee"



igus® ESD-tests  
 in the production line



Long travel test field: 125 m  
 travel length, speed 300 m/min



Cables are also tested  
 for torsion properties



Electronic check and archiving  
 for every chain production run



Push Pull forces speed up to 10 m/s, acceleration up to 200 m/s² are tested by igus®



Noise level test inside  
 an igus® acoustic cell

All products are tested and available from a single source.  
 Examples of test certificates and quality seals for igus® products:



...more instances are  
 available on request



# Quick and reliable. igus® delivery service.



## 8 to 8 plus Saturday service

**Over 80,000 products available!** Order 1m of Chainflex® cable or one chain link without any surcharge. Invoices and confirmations can be sent via post, fax or e-mail. 1,500 staff members in Germany and at 30 international subsidiaries, offices and igus®-distributors guarantee rapid delivery all over the world.

- Delivery and consultation daily from 8 am to 8 pm, Saturday from 8 am to 12 pm
- No minimum order values
- No surcharges
- Order tracking on the Internet right up to the point of delivery
- Simple returns procedure

## i-net customer information system

at [www.igus.de](http://www.igus.de) track your orders in real time with igus® i-net. Just request a password, log into i-net and track your jobstatus via a webcam. igus® i-net shipment tracking permits a monitoring of deliveries from igus® outlet right up to your doorstep.

- Detailed order data including an overview of target and actual deadlines
- Order confirmation via post, fax or e-mail as required
- Track your orders via webcam

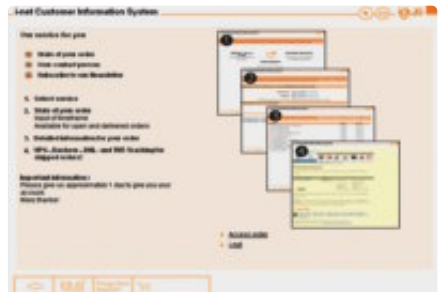

Request order tracking here: [www.igus.de/en/i-net](http://www.igus.de/en/i-net)

24<sub>h</sub>

24-48<sub>h</sub>

24-72<sub>h</sub>

3-10<sub>days</sub>

Individual components

Customized E-ChainSystems®

Simple pre-fabricated systems

Complex pre-fabricated systems

*For instance:*  
One E-Chain® link,  
6 m of E-Chain®,  
3 strain-relief elements

*For instance:*  
11.46 m of E-Chains®  
with interior separators,  
mounting brackets and  
strain relief elements  
according to your specifications.  
Additional with  
loose accessories as  
Chainflex®-cables,  
guiding troughs, mounting  
brackets, strain reliefs  
and assembly parts

*"Basic"*  
**ReadyChain®:**  
Simple customized  
E-ChainSystems® including  
installed cables without  
plug connections,  
labeled and tail-lengths  
according to your specifications

*Premium*  
**ReadyChain®:**  
Complex customized  
E-ChainSystem® including  
cables as well as plug  
connections, mounting  
brackets, tail-lengths and  
components according  
to your specifications.

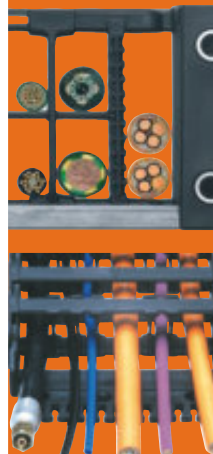
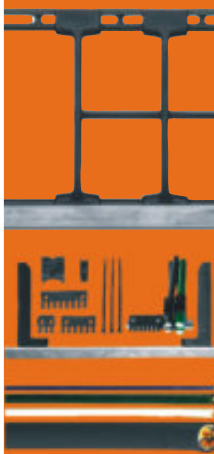

## The igus® story from 1964 to now

### Innovation with plastics

The igus® story begins on October 15th, 1964 with Günter Blase in a double garage in Cologne-Mülheim. In its first 20 years, igus® operated as a supplier of intricate technical plastic components. In 1983, son Frank Blase started to concentrate on full products like E-ChainSystems® and Polymer Bearings and established a separate marketing department. Between 1985 and 2007, igus® expanded from 40 over 1500 staff members distributed all over the world. igus® will continue to invest in expansion in the coming years. Modern materials have opened up further opportunities for innovative products



igus® Sales & Marketing, from left.: Tobias Vogel, Sales Manager Polymer Bearings; Harald Nehring, Authorized Representative E-ChainSystem® & Chainflex®; Gerhard Baus, Authorized Representative Polymer Plain Bearings; Michael Bläß, SalesManager E-ChainSystem® & Chainflex®; Frank Blase, CEO.

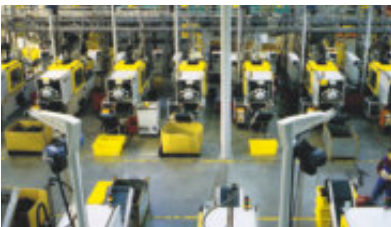

Today: Automated plastic production



Today: Large tool development and production facility

1965  
First iglidur®  
sliding element:  
Plug valve for  
the company  
Pierburg



1971  
First E-Chain®  
Series 20



1979  
First E-Chain®  
catalog of  
2 pages



# '65' '70' '75'

### Staff

### Products with variants



Company founders  
Günter and Margret  
Blase in front of their  
"double garage"  
from 1964

1980  
First polymer  
plain bearing  
catalog of  
8 pages



1989  
First Chainflex®  
cable CF1



1989  
E4 E-Tubes, to open  
on both sides



1991  
xigus 1.0  
electronic  
catalog



1993  
Introduction  
of DryLin® R



1994  
Introduction  
of igubal®



1995  
ReadyChain®,  
with the slogan  
Chain-Cable  
Guarantee

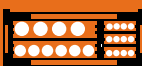

Chain cable  
guarantee!

1997  
DryLin® T



2001  
E6 - E-Chain®



2001  
DryLin® N



2003  
Triflex® R



2003  
DryLin® W



2006  
LeviChain  
DryLin® ZLW



# 80'85'90'95'00'06

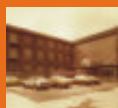

1977:  
Relocation to  
the Locher  
Mühle in  
Bergisch  
Gladbach



1994:  
Relocation  
to the new igus®  
factory in  
Cologne-Porz

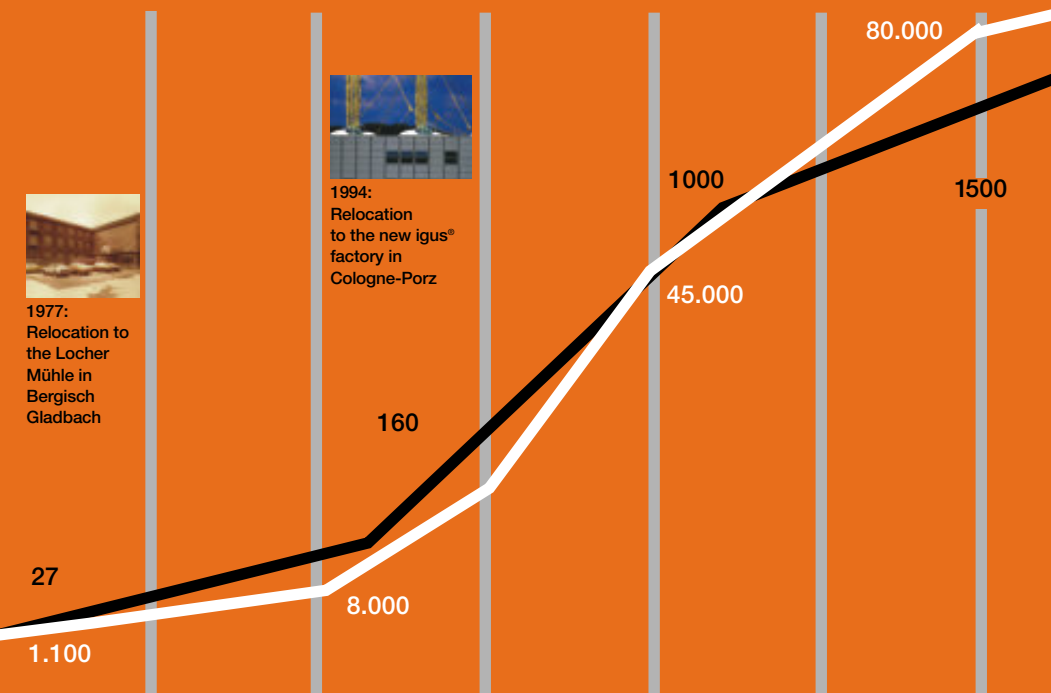

# The flexible igus®-factory

The environment at igus® is fully open - anyone can contact anyone else directly, everyone works at identical desks, has the same work equipment, the same choice of meals at the cafeteria and the same bathroom facilities.



For us, customers have the same significance as the sun to life on earth. The sun gives light, warmth and energy; our customers give us ideas, work and money.

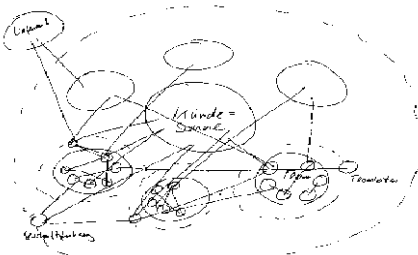

Find a video online ►  
[www.igus.de/igus\\_Film](http://www.igus.de/igus_Film)

After four building phases the base area of the factory of igus® Cologne is approx. 25000 m<sup>2</sup> - the total base area covers approx. 100.000 m<sup>2</sup>





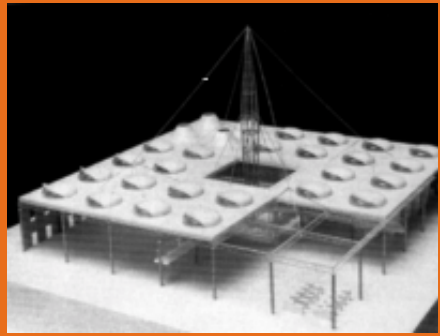
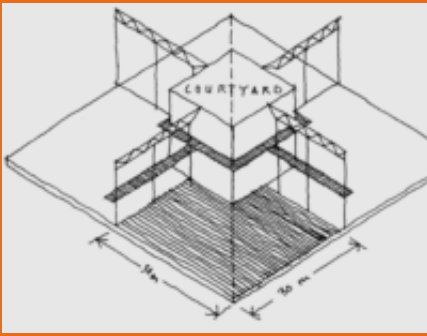

**Excerpt of architect's briefing...**

"In October 1988, igus® acquired a plot sized about 40,000 m<sup>2</sup> in the Porz-Lind district of Cologne. This will be the future site of development, production, sales, administration and planning. As the centre of all activities, this location will serve as the new igus® headquarters. igus® has made preparations for fast growth, fast change and flexible response in all areas...

Offering the necessary facilities and technology, the new "igus® premises" will also be designed to promote staff performance. The interior and exterior will be designed to reflect the enterprise's products and key philosophy: innovation - service - reliability, the customer being comparable to a solar system's centre orbited by all igus® staff and igus® entities dedicated toward solving the customer's problems."

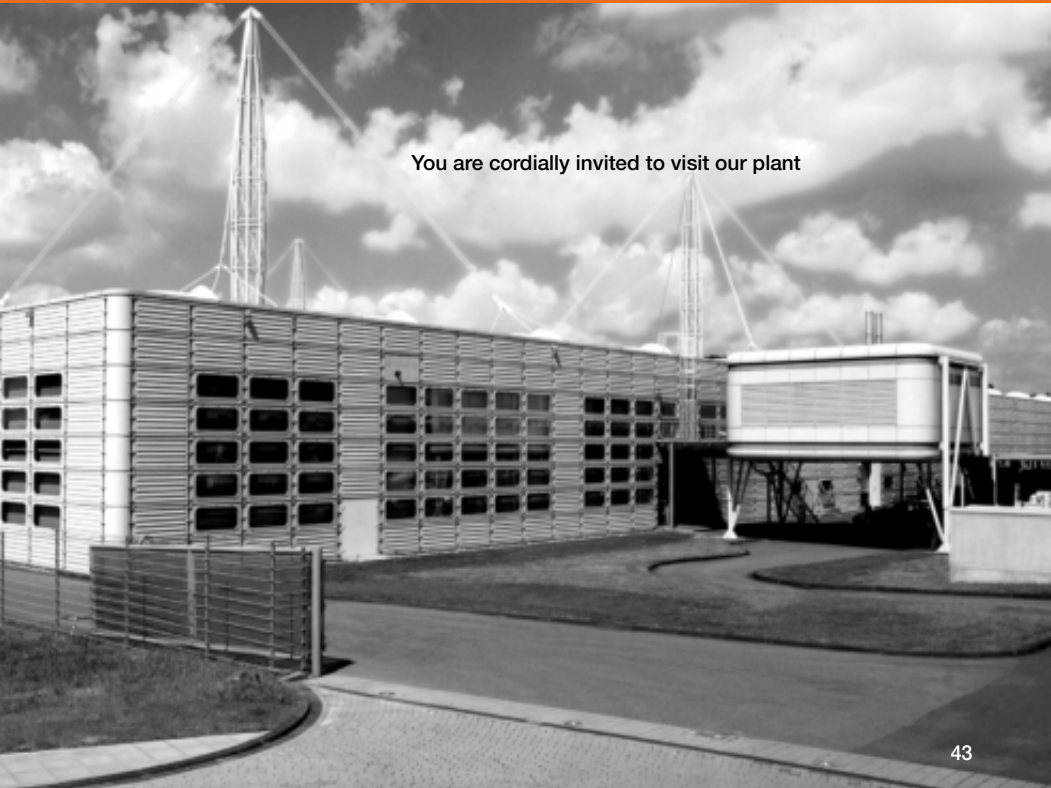

You are cordially invited to visit our plant

# How to use the catalog

## Price index

The price index allows comparisons with similar E-Chains® of the igus® program

## Series Overview

Opening principle of the selected E-Chain®

## Certifications

Available certifications and approvals for the E-Chain®

## Product illustration

Description of the E-Chain®, design structure and detailed product information

## Opening principle

How to open and close the E-Chain® and other assembly tips

## Performance test

Advantages and recommendations regarding this igus® product

## Order example for a complete E-ChainSystem®

**2400**  
**2450**  
**2480**  
**2500**

**igus®**

Price index

IPA Qualification Certificate Air Cleanroom Class ISO Class 3

ESD classification: Electrically conductive ESDWATEX version upon request

UL94 V2 classifications upon request



New snap-open mechanism, choice of snap-open on left or right. Hinged crossbar can be swivelled by more than 180° on both sides. Lightning-fast closing with the touch of a thumb. Secure fit without additional locking devices.

**+**

**When to use the Series 2400/2450/2480/2500**

- Snap-open accessible along both rails

at the connection point

- Modular interior separation
- Long service life is required
- Easy installation is required
- 1 "Half" E- Tube is required (Series 2450)
- 1 fully enclosed E- Tube is required (Series 2480)

**-**

**When not to use it:**

- If maximum stability is required
- System 54, Series 210, page 7-12
- If the application is very static
- Easy Chain®, Series E200, page 3-36
- System E2 E- Tubes, Series F40, page 5-26

E2/000 | Series 2400·2450·2480·2500

25 25

- Double stop stop for long unsupported length
- Opening system for rapid opening, either from the right or the left
- Cross bars with high locking range
- Latent glide surfaces for side-mounted operation
- Steel and bakelite links for shock-mounted operation
- Integrated strain relief possible
- Series 2400 and 2450 snap-open along inner radius
- Series 2450 "Half" E- Tube snap-operating inner radius, either from the right or the left
- Fully enclosed E- Tube Series 2480 snap-open along inner radius
- Easy assembly by optimized pin
- Also available as ESD version
- Strain relief separator (separator with integrated strain relief ▶ page 5-304)

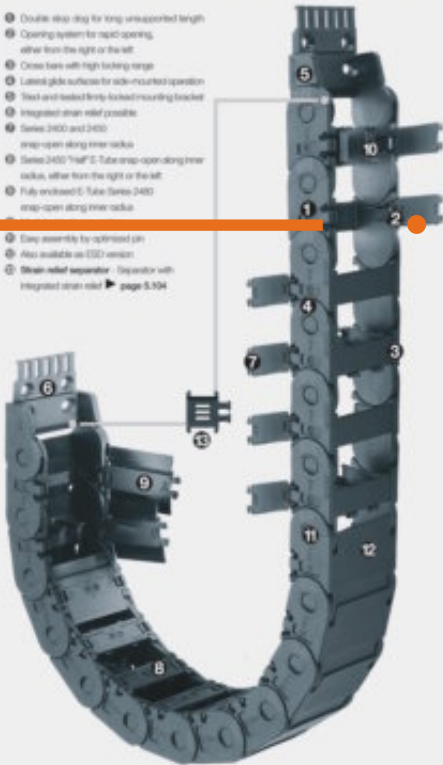

**Order example complete E-Chain®**

Please indicate chain-lengths or number of links. Example: 3 m or 66 links

3 m 2500.10.100.0  E-Chain®

with 2 separators 211 assembled every 2<sup>nd</sup> link  Interior separation

1 set 2100.34PZB+  Mounting bracket

5.94 Info ▶ [www.igus.de/en/2400](http://www.igus.de/en/2400) · [www.igus.de/en/2450](http://www.igus.de/en/2450) · [www.igus.de/en/2480](http://www.igus.de/en/2480) · [www.igus.de/en/2500](http://www.igus.de/en/2500)

**Calculation aid**  
Important details for configuring and calculating chain length as well as installation space

**Unsupported length**  
Diagram of unsupported length for the selected E-Chain®

**Series**  
Quickly find the requested Series

**Inner height**  
At a glance: Inner height and opening principle at the same location for each Series

**Chapter color**  
Every E-Chain® Series has a distinct chapter color permitting faster browsing

**Product range**

**Interior separators**

**Mounting brackets**

**Strain relief elements**

**Guide troughs**

**Assembly instructions**

**QuickLink** [www.igus.de/en/2400](http://www.igus.de/en/2400)

**Long travels**  
Important details for configuring and calculating chain length for long travels

Direct link to this product's online catalog: Free CAD-data, pdf files and more



E2400 | Series 2400-2450-2480-2500 | Dimension and Technical Data **igus®**

**Unsupported length**  
 $FL_{un}$  = with straight upper run  
 $FL_{un}$  = with parallel run  
 Further information ▶ page 1.12

**Pitch = 46 mm/link**   **Links/m = 22 (1012 mm)**   **Chain length =  $N_L + K$**

N	966	976	986	996	1006	1016	1026	1036	1046	1056	1066	1076	1086	1096	1106	1116
N	145	145	235	285	335	385	435	485	535							
D	129	130	170	185	225	265	310	355	400							
K	276	346	414	496	576	653	742	814	892							
$D_{un}$	-	-	380	440	500	555	605	650	700							
$K_2$	-	-	844	736	6212	1042	1472	1610	1754							

\*not available for Series 2400

**Long travel lengths from 10 m to max. 100 m**   **Chain length =  $N_L + K_2$**

**Gliding, long travel applications (max. 100 m)**  
 In the case of the "E-Chain" upper run without friction (e.g. 25 mm) on the lower run. We recommend to reduce the engineering of such a setup by our technicians.

**Technical Data**

Speed / acceleration	max. 200 (m/s) / max. 200 (m/s²)
Speed / acceleration	max. 20 (m/s) / max. 40 (m/s²)
Sliding speed / acceleration (maximum)	max. 10 (m/s) / max. 50 (m/s²)
Material / permitted operating temperature	igus® D-7-AD up to +120°C
Thermally stable material	IGUS 0004 RD (L3, L4, L6)

Details of material properties ▶ page 1.08

Phone +49- (0) 22 03-96 49-600   Fax +49- (0) 22 03-96 49-222

E2400 medium Inner height: 25 mm

5.56

# QuickLink: E-Chains® on the Internet

igus® plastics for longer life®

Products Services Shopping basket (0) Company Press Fairs

Home > E-ChainSystems® > Product overview > Energy Chains® E2000 medium > Series 2400

## Series 2400

Here you can configure your E-ChainSystem® individually. All entries and changes are taking over to the part list which is situated at the end of the page.

### Series 2400 - snap-open along inner radius

1. Tried-and-tested firmly-locked mounting bracket
2. Opening system for rapid opening
3. Semi-enclosed Energy Tube Series 2450
4. Series 2400 and 2450 snap-open along inner radius
5. Integrated strain relief possible
6. Lateral glide surfaces
7. Double stop dog

Inner widths B<sub>i</sub>: 25 up to 125 mm  
Bending radii R: 55 up to 250 mm  
Pitch: 46 mm per link = 22 links/m

**When to use Series 2400**

- Openable at the inner radius
- Integrated strain relief is required in the connection area
- Variable interior separation
- Long service life
- Easy assembly

**When not to use Series 2400**

- Maximum stability is required (e.g. in E4 Series 226, etc.)
- No chip guard (e.g. in E2, Series B-8)
- For simple applications (e.g. in E 200)

Price index:

Opening mechanism:

**Personal contact**  
igus® (UK) Ltd.  
51 Colwell Road

**Northampton**  
NN4 7PW

Fax: +44(0)1604 677242  
=> igus® contact  
E-mail: +44 (0) 1604-677240  
=> Send e-mail to igus®

**Application examples**

- 3D-CAD
- Samples, catalog and CD-ROM order
- E-Chain® comparison
- E-Chain® product finder
- PDF file
- Ask the product expert

7 widths and 9 bending radii

Go online and make use of  
all advantages at [www.igus.de](http://www.igus.de)

For every product in this catalog, there is a special QuickLink or direct online pointer to further useful details, data and facts. These include:

- Application videos and pictures
- Assembly instructions
- 3D-CAD files
- DXF data
- Comparisons and selection aids
- Online configuration tools
- Online wizard for calculations of service life
- PDF-data and other formats for download; ePlanDownload
- Personal support
- Catalog, CD and sample ordering forms

Example:  
[www.igus.de/en/2400](http://www.igus.de/en/2400)

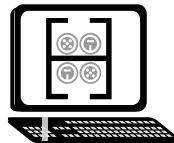

Create your complete E-Chain®  
with cables. A complete E-Chain-  
System® at few mouse clicks  
▶ [www.igus.de/en/konfigurator](http://www.igus.de/en/konfigurator)

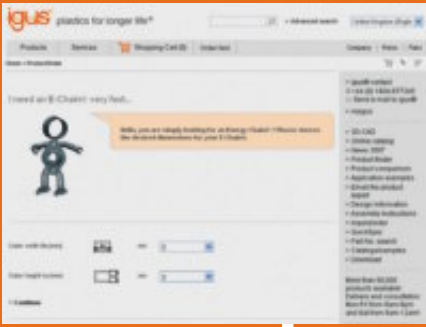

**"Search" - E-Chain® product finder**  
 Find the right E-Chain® quickly and easily by entering known application data and other parameters.

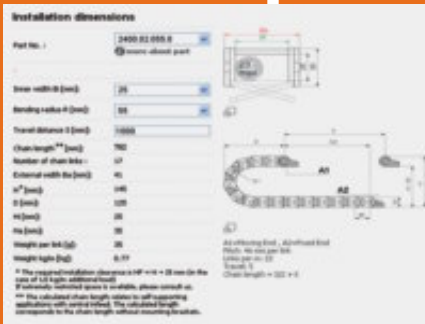

**"Calculate chain length" E-Chain® length calculation.**  
 Calculate the chain length and see all installation heights

**"Configure" E-Chain® interior separator configuration**

Quickly and easily determine interior separation for the selected chain via Drag & Drop. The configuration can be transferred automatically to your part list.

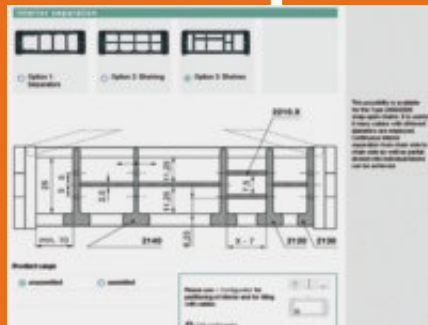

**"Generate 3D file" E-Chain® CAD library**

Download and save CAD data free of charge without having to register. Data on all products are updated and extended on a regular basis - nearly 30 3-D and 2-D formats are available here

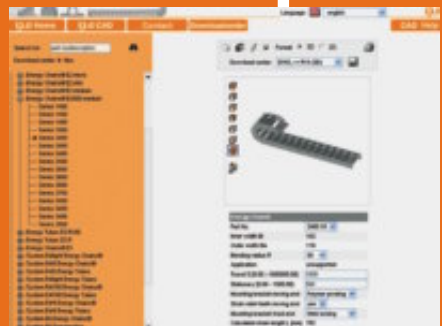

Take a tour: [www.igus.eu](http://www.igus.eu)



# Our entire product range is also available on CD



The free electronic products "xigus" and "xiglidur" are more than just a product catalog on CD-Rom. They help with the selection of igus® products and offer many other features

Download:  
[www.igus.eu](http://www.igus.eu)

## xigus 7.0:

### Simple design for your E-ChainSystem®

The user friendly interface allows "xigus" to configure your E-ChainSystems® quickly and easily, even providing a complete 3D file. Specific project data can be transferred directly. With just a few clicks you can enter data on length of travel, speed and acceleration. In the next step, the details concerning the cables are collected. You can add igus® Chainflex® cables with a mouse click, while hoses and other cables can be drawn up quickly. Parameters such as temperature, chemicals or contaminants are also input options, so you can determine exactly the right igus® E-Chain® range for your application.

- Quick, easy configuration of E-ChainSystems®, all the way to 3D file generation
- New, clearer product catalog for E-Chains® and Chainflex® cables, with all information on one page
- Direct takeover of individual project data
- 87 different 3D and 55 different 2D file formats
- Program range of more than 70.000 items
- Entire bills of material can be placed into the shopping cart
- No installation required
- Free of charge and available in six languages

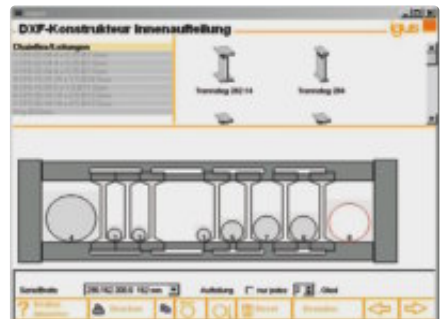
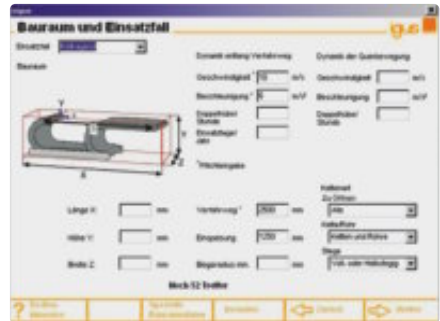

**Legal information**

The information in this catalog, and the data in the Design section in particular, is based on our current knowledge of the products described. No legally binding assurance in respect of characteristics or suitability for a specific intended application can be derived from it. igus® is unable to assume liability of any nature for damage, loss or injury resulting from application of the products. We recommend that you always check suitability of the products for a specific intended application in a practically oriented test. Please consult igus®. For reasons relating to ongoing technical developments, we reserve the right to implement technical modifications and improvement of the products at any time. Subject to printing errors. The terms "igus", "ReadyChain", "ReadyCable", "Chainflex", "E-Chain", "E-ChainSystem", "EnergyChain", "Energy Chain System", "E-Ketten", "E-KettenSysteme", "Flizz", "Easy Chain", "TwisterChain", "igubal", "iglidur", "DryLin", "Polysorb", "invis" and "plastics for longer life" are legally protected trademarks for igus® GmbH/Cologne in the Federal Republic of Germany and, where applicable, in some foreign countries.

# Selection by properties

## Large and strong or small and light

### "All-Rounder"...

#### E2/000

to open from one side,  
two-piece E-Chains® - standard! ▶ from page 5.78

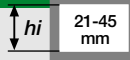

### ...heavier duty

#### E4/00

to open from both sides,  
big standard-kit ▶ from page 7.6

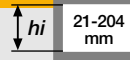

### micro

#### E2 micro

closed, smallest sizes,  
Inner height 5 - 15 mm ▶ from page 5.6

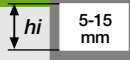

### mini

#### E2 mini

can be opened partly,  
Inner height 18 - 41 mm ▶ from page 5.34



### Easy to fill...

#### EasyChain®

very easy to fit - simply  
press cables in by hand! ▶ from page 3.1

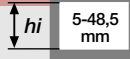

### ...Zipper

#### Zipper

E-Chain® and E-Tubes - lightning-  
fast opening and closing" ▶ from page 4.1

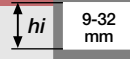

### Robust - high loads...

#### System E4/4

to open from both sides, fill  
weights up to 60 kg/m and more ▶ from page 7.86

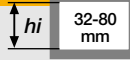

### ...lower weight

#### System E4/light

light weight,  
low cost, stabil ▶ from page 7.156

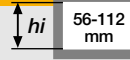

### Extra Large...

#### System E4

to open from both sides,  
Inner height up to 204 mm ▶ from page 7.56

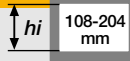

### Heavy Duty...

#### Heavy Duty-E-Chains®

for high loads and very  
high torsional-forces ▶ from page 7.148



## Dirt and debris protection

### E2 E-Tubes

to open from one side,  
medium sizes



▶ from page 6.1

## ...heavier duty

### E4 E-Tubes

to open from both sides,  
very robust



▶ from page 7.2

## Low-noise, minimum vibration

### System E3

small dimensions,  
fast to fill



▶ from page 8.4

## ...heavier duty

### System E6

to open from both sides,  
robust



▶ from page 8.34

## "Long travels" from 10 m

### Guide troughs

Guide trough-systems -  
aluminum and galvanized steel

▶ from page 9.1

### Rol E-Chain®

long travels without guide troughs,  
75% less push-/pull forces

▶ from page 9.78

## 3D-movements, robotic...

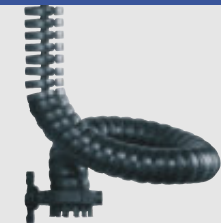

▶ from page 2.4

### Triflex® R

E-Chains® especially de-  
signed for robot-applica-  
tions and extreme torsion-  
al-movements

## ...nonrobotic



▶ from page 2.30

### Triflex®

Torsionable E-Chains® for  
multi-axis movements

## Rotary motion...



▶ from page 2.56

### TwisterChain®

igus® E-ChainSystem®  
for circle-movements  
up to 540°

## ...and "RBR"

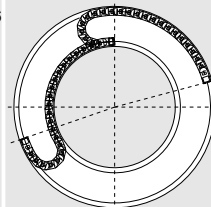

▶ from page 1.24

### Various E-Chains®

as igus® special so-  
lutions for circle-mov-  
ements with "reverse  
bending radii"

# Selection by inner heights

## Every millimetre counts



Inner height <i>hi</i> [mm]	Series	Product	Chapter	Page
<b>5 - 10 mm</b>				
5	03	E2 micro	5	5.10
5	E03	EasyChain®	3	3.6
7	04	E2 micro	5	5.14
7	E04	EasyChain®	3	3.10
9	047	Zipper	4	4.6
9,4	E045	EasyChain®	3	3.14
9,4	Z045	EasyChain®	3	3.14
10	E1.10	E1	3	3.64
10	05	E2 micro	5	5.22
10	E3.10	E3	8	8.10
<b>10,3 - 15 mm</b>				
10,3	045	E2 micro	5	5.18
10,3	07	Zipper	4	4.10
10,3	R07	Zipper E-Tube	4	4.28
10,5	06	E2 micro	5	5.26
10,7	E06	EasyChain®	3	3.20
10,7	Z06	EasyChain®	3	3.20
11,4	E065	EasyChain®	3	3.24
14,6	E08	EasyChain®	3	3.28
14,7	Z08	EasyChain®	3	3.28
15	E1.15	E1	3	3.64
15	08	E2 micro	5	5.30
15	E3.15	E3	8	8.14
15	09	Zipper	4	4.14
15	R09	Zipper E-Tube	4	4.32
<b>17 - 23 mm</b>				
17	E1.17	E1	3	3.64
17	B15	E2 mini	5	5.62
17	B15i	E2 mini	5	5.62
17	15	Zipper	4	4.18
18	10	E2 mini	5	5.40
18	TE/TZ14	SnapChain	3	3.66
19	E14	EasyChain®	3	3.32
19	Z14	EasyChain®	3	3.32
20	E1.20	E1	3	3.64
20	14	E2 mini	5	5.58
20	R15	Zipper E-Tube	4	4.36
21	R117	E2 E-Tube R100	6	6.6
21	R118	E2 E-Tube R100	6	6.6
21	1400	E2/000	5	5.84
21	1450	E2/000	5	5.84
21	1500	E2/000	5	5.84
21	1480	E2/000 E-Tube	5	5.84
21	210	E4/00	7	7.12
22	E3.22	E3	8	8.18
23	11.031	E2 mini	5	5.46

Inner height <i>hi</i> [mm]	Series	Product	Chapter	Page
<b>24 - 29 mm</b>				
24	255	E2 medium	5	5.130
24,3	E200	EasyChain®	3	3.36
24,3	E200.2	EasyChain®	3	3.36
24,3	Z200	EasyChain®	3	3.36
24,3	Z200.2	EasyChain®	3	3.36
25	R48	E2 E-Tube R	6	6.26
25	2400	E2/000	5	5.94
25	2450	E2/000	5	5.94
25	2500	E2/000	5	5.94
25	2480	E2/000 E-Tube	5	5.94
25,5	E-Band		12	12.50
28	11.080	E2 mini	5	5.50
28	220	E4/00	7	7.18
28	R760	E4/00 E-Tube	7	7.18
29	E6.29	E6	8	8.40
29	R6.29	E6 E-Tube	8	8.46
29	T3.29	T3 Band	8	8.28
<b>32 - 35 mm</b>				
32	B17	E2 mini	5	5.68
32	F17	E2 mini	5	5.74
32	280	E4/00	7	7.26
32	290	E4/00	7	7.26
32	R770	E4/00 E-Tube	7	7.26
32	2828	E4/4	7	7.92
32	2928	E4/4	7	7.92
32	R7728	E4/4 E-Tube	7	7.92
32	E16	EasyChain®	3	3.42
32	Z16	EasyChain®	3	3.42
32	17	Zipper	4	4.24
32	R17	Zipper E-Tube	4	4.42
35	R58	E2 E-Tube R	6	6.34
35	2600	E2/000	5	5.106
35	2650	E2/000	5	5.106
35	2700	E2/000	5	5.106
35	2680	E2/000 E-Tube	5	5.106
35	E6.35	E6	8	8.50
<b>36,5 - 48,5 mm</b>				
36,5	E26	EasyChain®	3	3.46
36,5	Z26	EasyChain®	3	3.46
37,1	E26.2	EasyChain®	3	3.46
37,1	E26.3	EasyChain®	3	3.46
37,1	Z26.2	EasyChain®	3	3.46
37,1	Z26.3	EasyChain®	3	3.46
40	R157	E2 E-Tube R100	6	6.12
40	R158	E2 E-Tube R100	6	6.12
40	E6.40	E6	8	8.56
40	R6.40	E6 E-Tube	8	8.62
41	11.1/11.2	E2 mini	5	5.54
42	380	E4/00	7	7.36



Inner height <i>h<sub>i</sub></i> [mm]	Series	Product	Chapter	Page
42	390	E4/00	7	7.36
42	R780	E4/00 E-Tube	7	7.36
42	3838	E4/4	7	7.104
42	3938	E4/4	7	7.104
42	R7838	E4/4 E-Tube	7	7.104
45	R68	E2 E-Tube R	6	6.42
45	3400	E2/000	5	5.118
45	3450	E2/000	5	5.118
45	3500	E2/000	5	5.118
45	3480	E2/000 E-Tube	5	5.118
47	TE/TZ26	SnapChain	3	3.66
48,5	E300	EasyChain®	3	3.52
48,5	E300.2	EasyChain®	3	3.52
48,5	E300.3	EasyChain®	3	3.52
48,5	Z300	EasyChain®	3	3.52
48,5	Z300.2	EasyChain®	3	3.52
48,5	Z300.3	EasyChain®	3	3.52
<b>50 - 56 mm</b>				
50	R167	E2 E-Tube R100	6	6.18
50	R168	E2 E-Tube R100	6	6.18
52	3822	E4/0	12	12.46
52	38022	E4/00	12	12.42
52	383822	E4/4	12	12.44
52	E6.52	E6	8	8.66
52	R6.52	E6 E-Tube	8	8.72
56	400	E4/00	7	7.46
56	410	E4/00	7	7.46
56	R880	E4/00 E-Tube	7	7.46
56	4040	E4/4	7	7.116
56	4140	E4/4	7	7.116
56	4040HD	E4/4 HD	7	7.128
56	R8840HD	E4/4 HD E-Tube	7	7.128
56	R8840	E4/4 E-Tube	7	7.116
56	14040	E4/light	7	7.162
56	14140	E4/light	7	7.162
56	R18840	E4/light E-Tube	7	7.162
<b>62 - 80 mm</b>				
62	14240	E4/light	7	7.172
62	14340	E4/light	7	7.172
62	E6.62	E6	8	8.76
80	5050	E4/4	7	7.136
80	5150	E4/4	7	7.136
80	5050HD	E4/4 HD	7	7.148
80	R9850HD	E4/4 HD E-Tube	7	7.148
80	R9850	E4/4 E-Tube	7	7.136
80	15050	E4/light	7	7.182
80	15150	E4/light	7	7.182
80	R19850	E4/light E-Tube	7	7.182
80	E6.80	E6	8	8.88
80	E6.80L	E6 light	8	8.82

Inner height <i>h<sub>i</sub></i> [mm]	Series	Product	Chapter	Page
<b>108 - 204 mm</b>				
108	600	E4/00	7	7.56
108	601	E4/00	7	7.56
108	R608	E4/00 E-Tube	7	7.56
112	640	E4/00	7	7.64
112	1640	E4/light	7	7.194
112	R1608	E4/light E-Tube	7	7.194
200	800	E4/00	7	7.74
204	840	E4/00	7	7.80
<b>3D-E-Chains®</b>				
max. 12,1	TRC/TRE.30	Triflex® R	2	2.4
□ 16	332.16	Triflex®	2	2.48
	333.16	Triflex®	2	2.48
2 x 13	E332.25	EasyTriflex®	2	2.36
	E333.25	EasyTriflex®	2	2.36
max. 15	TRC/TRE/TRL.40	Triflex® R	2	2.4
□ 32	332.32	Triflex®	2	2.48
	333.32	Triflex®	2	2.48
2 x 17	E332.32	EasyTriflex®	2	2.36
	E333.32	EasyTriflex®	2	2.36
max. 22,5	TRC/TRE/TRL.60	Triflex® R	2	2.4
max. 28	TRC/TRE/TRL.70	Triflex® R	2	2.4
2 x 26	E332.50	EasyTriflex®	2	2.36
	E333.50	EasyTriflex®	2	2.36
□ 50	332.50	Triflex®	2	2.48
	333.50	Triflex®	2	2.48
	352.50	Triflex®	2	2.48
	353.50	Triflex®	2	2.48
max. 32,9	TRC/TRE.85	Triflex® R	2	2.4
max. 37,5	TRC/TRE/TRL.100	Triflex® R	2	2.4
□ 75	332.75	Triflex®	2	2.48
	333.75	Triflex®	2	2.48
2 x 38,5	E332.75	EasyTriflex®	2	2.36
	E333.75	EasyTriflex®	2	2.36
<b>Circular movements</b>				
28 mm	2208	TwisterChain®	2	2.62
32 mm	2808	TwisterChain®	2	2.62
42 mm	3808	TwisterChain®	2	2.62
56 mm	4008	TwisterChain®	2	2.62

# Contents...

## by Series in ascending sequence

Series	Product	Page
03	E2 micro	5.10
04	E2 micro	5.14
045	E2 micro	5.18
047	Zipper	4.6
05	E2 micro	5.22
06	E2 micro	5.26
07	Zipper	4.10
08	E2 micro	5.30
09	Zipper	4.14
10	E2 mini	5.40
10 classics	E2 mini	12.6
11.031	E2 mini	5.46
11.080	E2 mini	5.50
11.1	E2 mini	5.54
11.2	E2 mini	5.54
14	E2 mini	5.58
140/141/R188	E4/light	12.26
1400/1450/1480/1500	E2/000	5.84
14040/14140/R18840	E4/light	7.162
142/143	E4/light	12.28
14240/14340	E4/light	7.172
15	Zipper	4.18
15 classic	Zipper	12.4
17	Zipper	4.24
150/151/R198	E4/light	12.30
15050/15150/R19850	E4/light	7.182
1640/R1608	E4/light	7.194
20	E2 medium	12.18
200	E2 medium	12.10
210	E4/00	7.12
22	E2 medium	12.32
220/R760	E4/00	7.18
2208	TwisterChain®	2.62
23	E2 medium	12.32
240	E2 medium	12.10
2400/2450/2480/2500	E2/000	5.94
25	E2 medium	12.18
250	E2 medium	12.10
255	E2 medium	5.130
26	E2 medium	12.12
2600/2650/2680/2700	E2/000	5.106
27	E2 medium	12.12
27i	E2 medium	12.12
28/29/R77	E4/0	12.34
280/290/R770	E4/00	7.26
2808	TwisterChain®	2.62
2828/2928/R7728	E4/4	7.92
30	E2 medium	12.20
332.16	Triflex®	2.48
332.32	Triflex®	2.48

Series	Product	Page
332.50	Triflex®	2.48
332.75	Triflex®	2.48
333.16	Triflex®	2.48
333.32	Triflex®	2.48
333.50	Triflex®	2.48
333.75	Triflex®	2.48
340	E2 medium	12.14
3400/3450/3480/3500	E2/000	5.118
35	E2 medium	12.20
350	E2 medium	12.14
352.50	Triflex®	2.48
353.50	Triflex®	2.48
36	E2 medium	12.20
38/39/R78	E4/0	12.36
380/390/R780	E4/00	7.36
38022	E4/00	12.42
3808	TwisterChain®	2.62
3822	E4/0	12.46
3838/3938/R7738	E4/4	7.104
383822	E4/4	12.44
40/41/R88	E4/0	12.38
400/410/R880	E4/00	7.46
4008	TwisterChain®	2.62
4040/4140/R8840	E4/4	7.116
4040HD/R8840HD	E4/4	7.128
50/51/R98	E4/0	12.40
5050/5150/R9850	E4/4	7.136
5050HD/R9850HD	E4/4	7.148
600/601/R608	E4/00	7.56
640	E4/00	7.64
800	E4/00	7.74
840	E4/00	7.80
B15	E2 mini	5.62
B15 classics	E2 mini	12.8
B15i	E2 mini	5.62
B17	E2 mini	5.68
E03	Easy Chain®	3.6
E04	Easy Chain®	3.10
E045	Easy Chain®	3.14
E06	Easy Chain®	3.20
E065	Easy Chain®	3.24
E08	Easy Chain®	3.28
E1.10	E1	3.64
E1.17	E1	3.64
E1.20	E1	3.64
E14	Easy Chain®	3.32
E16	Easy Chain®	3.42
E200	Easy Chain®	3.36
E26	Easy Chain®	3.46
E3.10	E3	8.10



# Contents...

## by product-group, series and page

### 1 Designing with igus® E-Chains®

<b>Introduction</b>		Side-mounted applications.....	1.24
Designing with igus®.....	1.1	Rotarymotion application.....	1.26
igus® terms in alphabetical order.....	1.4	<b>Cable and hose Ppackages</b> .....	1.28
Calculation of E-Chain®-lengths and camber.....	1.5	Strain relief elements .....	1.32
<b>Applications</b> .....	1.6	<b>Technical data and standards</b>	
Unsupported - short travel applications.....	1.8	ESD/ATEX.....	1.34
Unsupported - noise-optimized.....	1.11	Clean-Room .....	1.36
<b>Load diagrams <math>FL_G/FL_B</math></b> .....	1.12	Technical environment.....	1.37
Gliding - long travel applications.....	1.16	Material data .....	1.38
Vertical - hanging applications.....	1.20	Chemical resistance and colors.....	1.39
"Zig-zag" - hanging applications.....	1.21	Certificates.....	1.40
Vertical - standing applications.....	1.22	<b>ReadyChain®</b> .....	1.41

### 2 Triflex® R, Easy Triflex®, Triflex®, TwisterChain®

<b>Triflex® R</b>	<b>Easy Triflex®</b>	<b>Triflex®</b>	<b>TwisterChain®</b>
TRC/TRE/TRL.....	E332/E333.....	332/333/352/353.....	2208/2808.....
2.4	2.36	2.48	2.62
			3808/4008.....
			2.62

### 3 Easy Chain®, System E1 and Snapchain

<b>Easy Chain®</b>	E065.....	E26/Z26.....	E1.17.....
E03.....	3.6	E300/Z300.....	3.64
E04.....	3.10	<b>E1</b>	E1.15.....
E045/Z045.....	3.14	E1.05.....	3.64
E06/Z06.....	3.20	E1.10.....	3.64
	E08/Z08.....		<b>SnapChain</b>
	3.28		TE/TZ.....
	E14/Z14.....		3.66
	3.32		
	E200/Z200.....		
	3.36		
	E16/Z16.....		
	3.42		

### 4 Zipper - zip-open E-Chains® and zip-open E-Tubes

<b>Zipper E-Chains®</b>	09.....	<b>Zipper E-Tubes</b>	R15.....
047.....	4.6	R07.....	4.36
07.....	4.10	R09.....	4.42
	09.....		
	4.14		
	15.....		
	4.18		
	17.....		
	4.24		

### 5 System E2 micro, mini and E2/000

<b>E2 micro</b>	<b>E2 mini</b>	B17.....	2600/2700.....
03.....	5.10	F17.....	5.106
04.....	5.14	<b>E2/000</b>	2650/2680.....
045.....	5.18	1400/1500.....	5.118
05.....	5.22	1450/1480.....	5.118
06.....	5.26	2400/2500.....	5.130
08.....	5.30	2450/2480.....	
	11.031.....		
	5.46		
	11.080.....		
	5.50		
	11.1/11.2.....		
	5.54		
	14.....		
	5.58		
	B15/B15i.....		
	5.62		

### 6 E2 E-Tubes Serie R100 and Serie R

<b>Series R100</b>	R157/R158.....	<b>Series R</b>	R58.....
R117/R118.....	6.6	R48.....	6.34
	R167/R168.....	6.26	R68.....
	6.18		6.42

## 7 System E4 - E4/00, E4/4, E4/light

<b>E4/00</b>	640.....	<b>7.64</b>	4040HD/R8840HD ...	<b>7.128</b>	15050/15150/
210.....	800.....	<b>7.74</b>	5050/5150/R9850....	<b>7.136</b>	R19850.....
220/R760.....	840.....	<b>7.80</b>	5050HD/R9850HD...	<b>7.148</b>	1640/R1608.....
280/290/R770.....	<b>E4/4</b>		<b>E4/light</b>		
380/390/R780.....	2828/2928/R7728.....	<b>7.92</b>	14040/14140/		
400/410/R880.....	3838/3938/R7838....	<b>7.104</b>	R18840.....	<b>7.162</b>	
600/601/R608.....	4040/4140/R8840....	<b>7.116</b>	14240/14340.....	<b>7.172</b>	

## 8 System E3, T3 and System E6 - extremely low-noise operation

<b>E3</b>	<b>T3</b>	<b>E6</b>	E6.52.....	<b>8.66</b>
E3.10.....	T3.29.....	E6.29.....	R6.52.....	<b>8.72</b>
E3.15.....		R6.29.....	E6.62.....	<b>8.76</b>
E3.22.....		E6.35.....	E6.80L.....	<b>8.82</b>
		E6.40.....	E6.80.....	<b>8.88</b>

## 9 Solutions for long travels - with or without guide troughs

<b>Super-alu-trough</b>	975.30./975.31. ....	<b>9.38</b>	90.30 / 90.31. ....	<b>9.60</b>	93.930. ....	<b>9.69</b>
Fixed end alu . ....	<b>Steel trough</b>		Fixed end steel . ....	<b>9.62</b>	95.930. ....	<b>9.69</b>
970.30./970.31. ....	92.30 / 92.31. ....	<b>9.44</b>	91.10 - 91.51. ....	<b>9.63</b>	<b>Long travels</b>	
970.30./970.32. ....	95.30 / 95.31. ....	<b>9.46</b>	<b>Tubular trough system RS</b>		<b>without guide troughs</b>	
971.30./971.31. ....	99.30 / 99.31. ....	<b>9.48</b>	92.70 / 92.71. ....	<b>9.64</b>	AUTO-GLIDE.....	<b>9.72</b>
972.02.30./972.02.31. .	97.30 / 97.31. ....	<b>9.50</b>	93.70 / 93.71. ....	<b>9.66</b>	RoI E-Chain®.....	<b>9.78</b>
972.30./972.31. ....	93.30 / 93.31. ....	<b>9.52</b>	95.70 / 95.71. ....	<b>9.67</b>	LBT Flizz®.....	<b>9.82</b>
972.30./972.32. ....	94.30 / 94.31. ....	<b>9.54</b>	<b>Snap-in trough system SP</b>		Micro Flizz®.....	<b>9.86</b>
973.30./973.31. ....	96.30 / 96.31. ....	<b>9.56</b>	91.930. ....	<b>9.68</b>	LeviChain.....	<b>9.92</b>
974.30./974.31. ....	98.30 / 98.31. ....	<b>9.58</b>	92.930. ....	<b>9.68</b>		

## 10 igus® Chainfix strain relief

<b>Chainfix clamps</b>	<b>Tiewrap plates</b>	<b>Chainfix</b>	<b>Chainfix strain</b>
<b>steel</b> .....	<b>universal</b> .....	<b>clips</b> .....	<b>relief separator</b> .....
10.4	10.8	10.10	10.10
<b>Chainfix clamps</b>	<b>Tiewrap plates</b>	<b>Chainfix</b>	<b>Chainfix</b>
<b>stainless steel</b> .....	<b>for C-profile</b> .....	<b>nuggets</b> .....	<b>blocks</b> .....
10.4	10.9	10.10	10.11

## 12 Classic-Series, line-extensions and special solutions

<b>"Classic"-Series</b>	30/35/36 E2 med. ....	<b>12.20</b>	38/39/R78 E4/0.....	<b>12.36</b>	E-Band.....	<b>12.50</b>
15 classic Zipper.....	R58 classic E2 Tubes.....	<b>12.22</b>	40/41/R88 E4/0.....	<b>12.38</b>	<b>Appendix</b>	
10 classic E2 mini.....	R68 classic E2 Tubes.....	<b>12.24</b>	50/51/R98 E4/0.....	<b>12.40</b>	<b>Fax forms from</b> .....	<b>12.53</b>
B15 classic E2 mini.....	140/141/R188 E4/light ..	<b>12.26</b>	<b>Line extensions</b>		<b>Selection guide</b> .....	<b>12.61</b>
200/240/250 E2 med. ....	142/143 4/light.....	<b>12.28</b>	<b>and special solutions</b>		<b>Terminology index</b> .....	<b>12.62</b>
26/27/27 E2 med. ....	150/151/R198 E4/light ..	<b>12.30</b>	38022 E4/00.....	<b>12.42</b>	<b>igus® addresses</b> .....	<b>12.64</b>
340/350 E2 med. ....	22/23/R76 E4/0.....	<b>12.32</b>	383822 E4/4.....	<b>12.44</b>		
20/25 E2 med. ....	28/29/R77E4/0.....	<b>12.34</b>	3822 E4/0.....	<b>12.46</b>		



# Triflex® and TwisterChain®

## Legend

- Standard
- Suitable to only a limited extent
- ▲ Options
- Especially suitable
- \* In preparation / on request

Series	Inner height <i>hi</i> [mm] ø cable max.	Inner width <i>Bi</i> [mm] from - to	Outer height <i>ha</i> [mm]	Outer width <i>Ba</i> [mm] from - to	Bending radii <i>R</i> [mm] from - to	Pitch [mm]

## Triflex® R - 3-D E-Chain® for robot applications

### TRC - Triflex®, R closed design



TRC.30	<b>30,5</b>	ø 10	ø 30,5	ø 34,5	ø 34,5	50	11,3
TRC.40	<b>38</b>	ø 13	ø 38	ø 43	ø 43	58	13,9
TRC.60	<b>57</b>	ø 20,5	ø 57	ø 65	ø 65	87	20,4
TRC.70	<b>71,5</b>	ø 26	ø 71,5	ø 81	ø 81	110	25,6
TRC.85	<b>83</b>	ø 31	ø 83	ø 94,5	ø 94,5	135	30,6
TRC.100	<b>95</b>	ø 35,5	ø 95,3	ø 108	ø 108	145	34,5

### TRE - Triflex® R, "Easy" design for fast installation of conduits



TRE.30	<b>30,5</b>	ø 10	ø 30,5	ø 34,5	ø 34,5	50	11,3
TRE.40	<b>38</b>	ø 13	ø 38	ø 43	ø 43	58	13,9
TRE.60	<b>57</b>	ø 20,5	ø 57	ø 65	ø 65	87	20,4
TRE.70	<b>71,5</b>	ø 26	ø 71,5	ø 81	ø 81	110	25,6
TRE.85	<b>83</b>	ø 31	ø 83	ø 94,5	ø 94,5	135	30,6
TRE.100	<b>95</b>	ø 35,5	ø 95,3	ø 108	ø 108	145	34,5

### TRL - Triflex® R, light version with "Easy" Design



TRL.40	<b>38</b>	ø 13	ø 38	ø 45	ø 45	58	13,9
TRL.60	<b>57</b>	ø 21	ø 57	ø 65	ø 65	87	20,4
TRL.70	<b>71,5</b>	ø 26	ø 71,5	ø 81	ø 81	110	25,6
TRL.100	<b>95,3</b>	ø 35,5	ø 95,3	ø 108	ø 108	145	34,5

## Easy Triflex® - for 3-D motion - simple filling from 2 sides



E332.25	<b>25</b>	ø 9	25	34	34	48 - 200	14,5
E332.32	<b>32</b>	ø 12	32	50	50	75 - 250	25
E332.50	<b>50</b>	ø 21	50	68	68	100 - 250	30
E332.75	<b>75</b>	ø 33	75	96	96	140 - 300	36
E333.25	<b>25</b>	ø 9	25	34	34	48 - 200	14,5
E333.32	<b>32</b>	ø 12	32	50	50	75 - 250	25
E333.50	<b>50</b>	ø 21	50	68	68	100 - 250	30
E333.75	<b>75</b>	ø 33	75	96	96	140 - 300	36

## Triflex® - for 3-D motion - closed

### Triflex®, closed design



332.16	<b>16</b>	ø 14	16	26	26	38 - 100	13,3
332.32	<b>32</b>	ø 28	32	50	50	75 - 250	25
332.50	<b>50</b>	ø 45	50	68	68	100 - 250	30
332.75	<b>75</b>	ø 67	75	96	96	140 - 300	36
333.16	<b>16</b>	ø 14	16	26	26	38 - 100	13,3
333.32	<b>32</b>	ø 28	32	50	50	75 - 250	25
333.50	<b>50</b>	ø 45	50	68	68	100 - 250	30
333.75	<b>75</b>	ø 67	75	96	96	140 - 300	36

### Triflex®, to open









352.50	<b>50</b>	ø 45	50	68	68	100 - 250	30
353.50	<b>50</b>	ø 45	50	68	68	100 - 250	30

## TwisterChain® - for circular and spiral movements



2208	<b>28</b>	ø 25	52,5 - 112,5	42	80 - 140	55 - 150	44
2808	<b>32</b>	ø 29	50 - 150	54	81 - 181	100 - 250	56
3808	<b>42</b>	ø 39	50 - 200	64	85 - 235	100 - 250	67
4008	<b>56</b>	ø 53	50 - 200	84	93 - 243	150 - 400	91



Unsupported fill weight max [kg/m]	Unsupported length max [m]	Opening principle	Interior separation possibilities...			ESD/ATEX	Clean-Room	UL-V2	Low noise	Price index	Page	
			Separators	Full-width shelves	Shelves							
-	-	 Closed	●	-	-	▲	○	●	●	●●●●	2.12	
-	-		●	-	-	▲	○	●	●	●●●●	2.12	
-	-		●	-	-	▲	○	●	●	●●●●	2.12	
-	-		●	-	-	▲	○	●	●	●●●●	2.12	
-	-		●	-	-	▲	○	●	●	●●●●	2.12	
-	-		●	-	-	▲	○	●	●	●●●●	2.12	
-	-	 Easy to fill from both sides	●	-	-	▲	○	●	●	●●●●	2.14	
-	-		●	-	-	▲	○	●	●	●●●●	2.14	
-	-		●	-	-	▲	○	●	●	●●●●	2.14	
-	-		●	-	-	▲	○	●	●	●●●●	2.14	
-	-		●	-	-	▲	○	●	●	●●●●	2.14	
-	-		●	-	-	▲	○	●	●	●●●●	2.14	
-	-	 Light version Easy-principle	●	-	-	▲	○	●	●	●●●●	2.16	
-	-		●	-	-	▲	○	●	●	●●●●	2.16	
-	-		●	-	-	▲	○	●	●	●●●●	2.16	
-	-		●	-	-	▲	○	●	●	●●●●	2.16	
-	-	 Easy to fill from both sides	●	-	-	▲	○	●	●	●●●●	2.36	
-	-		●	-	-	▲	○	●	●	●●●●	2.36	
-	-		●	-	-	▲	○	●	●	●●●●	2.36	
-	-		●	-	-	▲	○	●	●	●●●●	2.36	
-	-		●	-	-	▲	○	●	●	●●●●	2.36	
-	-		●	-	-	▲	○	●	●	●●●●	2.36	
-	-		●	-	-	▲	○	●	●	●●●●	2.36	
-	-		●	-	-	▲	○	●	●	●●●●	2.36	
-	-	 Closed	-	-	-	▲	○	▲	○	●●●●	2.48	
-	-		●	-	-	▲	○	▲	○	●●●●	2.48	
-	-		●	-	-	▲	○	▲	○	●●●●	2.48	
-	-		●	-	-	▲	○	▲	○	●●●●	2.48	
-	-		●	-	-	▲	○	▲	○	●●●●	2.48	
-	-		●	-	-	▲	○	▲	○	●●●●	2.48	
-	-		●	-	-	▲	○	▲	○	●●●●	2.48	
-	-		●	-	-	▲	○	▲	○	●●●●	2.48	
-	-	 Lids to open	●	-	-	▲	○	▲	○	●●●●	2.48	
-	-		●	-	-	▲	○	▲	○	●●●●	2.48	
1,0	1,0	360°	 To open from both sides	●	●	●	▲	○	▲	●	●●●●	2.62
2,0	1,0	360°		●	●	●	▲	○	▲	●	●●●●	2.62
3,0	1,8	360°		●	●	●	▲	○	▲	●	●●●●	2.62
4,0	2,5	360°		●	●	●	▲	○	▲	●	●●●●	2.62

# Zipper, Easy Chain® and System E1

## Legend

- Standard
- Suitable to only a limited extent
- ▲ Options
- Especially suitable
- \* In preparation / on request

Series

Inner height  
*hi* [mm]  
ø cable max.



Inner width  
*Bi* [mm]  
from - to



Outer height  
*ha* [mm]



Outer width  
*Ba* [mm]  
from - to



Bending radius  
*R* [mm]  
from - to



Pitch  
[mm]



## Easy Chain® - easy to fit - simply press cables in

### Easy Chain®, split crossbar along the **outer** radius



E03	<b>5</b>	ø 3	5 - 10	8	8,7 - 13,7	10 - 28	10
E04	<b>7</b>	ø 4,5	7	10	13	15 - 48	16,7
E045	<b>9,4</b>	ø 5,5	10 - 16	12,5	16 - 23	18 - 38	13
E06	<b>10,7</b>	ø 6,5	10 - 16	15	16,5 - 22,5	18 - 38	20
E065	<b>11,4</b>	ø 7	10 - 36	15	18,8 - 49,3	18 - 38	15
E08	<b>14,6</b>	ø 10	10 - 50	19,3	18,2 - 58,2	28 - 48	20
E14	<b>19</b>	ø 13	15 - 50	25	27 - 62	28 - 125	30,5
E200	<b>24,3</b>	ø 20	57	35	74,4	55 - 200	46
E200.2	<b>24,3</b>	ø 18	37 - 50	35	94,4 - 120,4	55 - 200	46
E16	<b>32</b>	ø 25	23 - 100	39	37,5 - 115,3	60 - 125	30,5
E26	<b>36,5</b>	ø 28	75	50	92	63 - 250	56
E26.2	<b>37,1</b>	ø 20	48	50	117	63 - 250	56
E26.3	<b>37,1</b>	ø 20	47	50	167	63 - 250	56
E300	<b>48,5</b>	ø 35	75	64	95	75 - 300	67
E300.2	<b>48,5</b>	ø 18	48/48	64	120	75 - 300	67
E300.3	<b>48,5</b>	ø 18	46/46/46	64	170	75 - 300	67

### Easy Chain®, split crossbar along the **inner** radius



Z045	<b>9,4</b>	ø 5,5	16	12,5	23	18 - 38	13
Z06	<b>10,5</b>	ø 6,5	10 - 16	15	16,5 - 22,5	18 - 38	20
Z08	<b>14,7</b>	ø 10	10 - 50	19,3	18,2 - 58,2	28 - 48	20
Z14	<b>19</b>	ø 13	15 - 50	25	27 - 62	28 - 125	30,5
Z200	<b>24,3</b>	ø 20	57	35	74,4	55 - 200	46
Z200.2	<b>24,3</b>	ø 18	37 - 50	35	94,4 - 120,4	55 - 200	46
Z16	<b>32</b>	ø 25	23 - 100	39	37,5 - 115,3	40 - 125	30,5
Z26	<b>36,5</b>	ø 28	75	50	92	63 - 250	56
Z26.2	<b>37,1</b>	ø 20	48	50	117	63 - 250	56
Z26.3	<b>37,1</b>	ø 20	47	50	167	63 - 250	56
Z300	<b>48,5</b>	ø 35	75	64	95	75 - 300	67
Z300.2	<b>48,5</b>	ø 18	48/48	64	120	75 - 300	67
Z300.3	<b>48,5</b>	ø 18	46/46/46	64	170	75 - 300	67

## System E1 - modular, 1-piece strip design for simple applications

### System E1, zip-open along the **outer** radius



E1.05	<b>05</b>	ø 4,5	05	12	12	28 - 75	25
E1.10	<b>10</b>	ø 9	10-13	17-25	17-26	28 - 75	20-25
E1.15	<b>15</b>	ø 13,5	40	22	47	28 - 75	25
E1.17	<b>17</b>	ø 15,3	21-44	25	26-49	28 - 48	25,5
E1.20	<b>20</b>	ø 18	15	27	22	28 - 75	25

## Zipper E-Chain® and E-Tubes - lightning-fast opening and closing

### Zipper, zip-open along the **outer** radius



047	<b>9</b>	ø 7	10 - 16	12,5	16 - 22	18 - 38	13
07	<b>10,3</b>	ø 8	6 - 64	15	12,5 - 71	18 - 38	20
09	<b>15</b>	ø 13	10 - 50	19,3	18,2 - 58,2	28 - 48	20
15	<b>17</b>	ø 15	15 - 100	24	26 - 113	38 - 180	30,5
17	<b>32</b>	ø 28	15 - 100	39	26 - 113	63 - 125	30,5

### Zipper E-Tube, zip-open along the **outer** radius



R07	<b>10,3</b>	ø 8	10 - 50	15	16,5 - 57	38 - 48	20
R09	<b>15</b>	ø 12,5	10 - 50	19,3	18,2 - 58,2	48 - 100	20
R15	<b>17</b>	ø 15	15 - 100	24	26 - 113	63 - 180	30,5
R17	<b>32</b>	ø 28	15 - 100	39	26 - 113	63 - 125	30,5



Unsupported fill weight max [kg/m]	Unsupported length max [m]	Long travel max [m]	Opening principle	Interior separation possibilities...			ESD/ATEX	Clean-Room	UL-V2	Low noise	Price index	Page
				Separators	Full-width shelves	Shelves						

0,23	0,375	-		-	-	-	○	■	●	■	●●●●	3,6
0,35	0,5	-		-	-	-	○	■	●	●	●●●●	3,10
0,25	0,375	-		-	-	-	○	■	●	■	●●●●	3,14
0,45	0,55	-		-	-	-	○	■	●	●	●●●●	3,20
0,45	0,6	-		-	-	-	○	■	●	●	●●●●	3,24
0,7	1,0	-		-	-	-	○	■	●	●	●●●●	3,28
0,5	0,65	-		-	-	-	○	■	●	●	●●●●	3,32
2,0	1,75	-		-	-	-	○	■	●	●	●●●●	3,36
2,0	1,75	-		●	-	-	○	■	●	●	●●●●	3,36
0,75	1,0	-		-	-	-	○	■	●	●	●●●●	3,42
4,0	2,0	-		-	-	-	○	■	●	●	●●●●	3,46
4,0	2,0	-		●	-	-	○	■	●	●	●●●●	3,46
4,0	2,0	-		●	-	-	○	■	●	●	●●●●	3,46
8,0	2,2	-		-	-	-	○	■	●	●	●●●●	3,52
8,0	2,2	-		●	-	-	○	■	●	●	●●●●	3,52
8,0	2,2	-	●	-	●	○	■	●	●	●●●●	3,52	

0,25	0,375	-		-	-	-	○	■	●	■	●●●●	3,14
0,45	0,55	-		-	-	-	○	■	●	●	●●●●	3,20
0,7	1,0	-		-	-	-	○	■	●	●	●●●●	3,28
0,5	0,65	-		-	-	-	○	■	●	●	●●●●	3,32
2,0	1,75	-		-	-	-	○	■	●	●	●●●●	3,36
2,0	1,75	-		●	-	-	○	■	●	●	●●●●	3,36
0,7	1,0	-		-	-	-	○	■	●	●	●●●●	3,42
4,0	2,0	-		-	-	-	○	■	●	●	●●●●	3,46
4,0	2,0	-		●	-	-	○	■	●	●	●●●●	3,46
4,0	2,0	-		●	-	-	○	■	●	●	●●●●	3,46
8,0	2,2	-		-	-	-	○	■	●	●	●●●●	3,52
8,0	2,2	-		●	-	-	○	■	●	●	●●●●	3,52
8,0	2,2	-		●	-	-	○	■	●	●	●●●●	3,52
8,0	2,2	-		●	-	●	○	■	●	●	●●●●	3,52

*	-	-		-	-	-	○	●	▲	●	●●●●	3,64
*	-	-		-	-	-	○	●	▲	●	●●●●	3,64
*	-	-		-	-	-	○	●	▲	●	●●●●	3,64
*	-	-		-	-	-	○	●	▲	●	●●●●	3,64
*	-	-		-	-	-	○	●	▲	●	●●●●	3,64

0,25	0,375	-		-	-	-	○	●	▲	■	●●●●	4,6
0,4	0,55	-		-	-	-	○	●	▲	■	●●●●	4,10
0,7	1,0	-		-	-	-	○	●	▲	■	●●●●	4,14
1,5	1,2	-		●	●	-	○	●	▲	■	●●●●	4,18
1,0	1,0	-		●	●	-	○	●	▲	■	●●●●	4,24

0,4	0,55	-		-	-	-	○	●	▲	■	●●●●	4,28
0,7	1,0	-		-	-	-	○	●	▲	■	●●●●	4,32
1,5	1,2	-		●	●	-	○	●	▲	■	●●●●	4,36
1,5	1,2	-		●	●	-	○	●	▲	■	●●●●	4,42

# E2 micro, mini and E2/000

## Legend

- Standard
- Suitable to only a limited extent
- ▲ Options
- Especially suitable
- \* In preparation / on request

Series

Inner height  
 $h_i$  [mm]  
ø cable max.



Inner width  
 $B_i$  [mm]  
from - to



Outer height  
 $h_a$  [mm]



Outer width  
 $B_a$  [mm]  
from - to



Bending radii  
 $R$  [mm]  
from - to

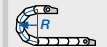

Pitch  
[mm]



## E2 micro - one-piece E-Chains® - small sizes

### E2 micro, non snap-open



Series	Inner height $h_i$ [mm]	Inner width $B_i$ [mm]	Outer height $h_a$ [mm]	Outer width $B_a$ [mm]	Bending radii $R$ [mm]	Pitch [mm]
03	5	ø 3,5	5 - 10	8	8,7 - 13,7	10 - 28
04	7	ø 5	7 - 30	10	12 - 35	15 - 48
045	10,3	ø 8	6 - 64	12,5	12 - 70	18 - 38
05	10	ø 8	6 - 64	12	10 - 68	18 - 38
06	10,5	ø 8	6 - 64	15	12,5 - 71	18 - 38
08	15	ø 12	10 - 50	19,3	18,2 - 58,2	28 - 48

## E2 mini - one/two-piece E-Chains® - small and medium sizes

### E2 mini, non snap-open



Series	Inner height $h_i$ [mm]	Inner width $B_i$ [mm]	Outer height $h_a$ [mm]	Outer width $B_a$ [mm]	Bending radii $R$ [mm]	Pitch [mm]
10	18	ø 16	15 - 100	23	26 - 113	28 - 180
11.031	23	ø 21	31	28	41,2	45 - 70
11.080	28	ø 26	80	33,4	93	38
11.1/11.2	41	ø 22	15 - 25	46	25,5 - 35,5	40 - 100

### E2 mini, snap-open along inner radius



Series	Inner height $h_i$ [mm]	Inner width $B_i$ [mm]	Outer height $h_a$ [mm]	Outer width $B_a$ [mm]	Bending radii $R$ [mm]	Pitch [mm]
14	20	ø 16	15 - 50	26	26 - 61	28 - 125
B15i	17	ø 14	15 - 100	23	26 - 113	38 - 180
F17	32	ø 28	15 - 100	39	26 - 113	48 - 125

### E2 mini, snap-open along outer radius



Series	Inner height $h_i$ [mm]	Inner width $B_i$ [mm]	Outer height $h_a$ [mm]	Outer width $B_a$ [mm]	Bending radii $R$ [mm]	Pitch [mm]
B15	17	ø 14	15 - 100	23	26 - 113	38 - 180
B17	32	ø 28	15 - 100	39	25,5 - 113	48 - 125

## E2/000 E-Chain® - two-piece E-Chains® - the E2 standard!

### E2/000, snap-open along inner radius



Series	Inner height $h_i$ [mm]	Inner width $B_i$ [mm]	Outer height $h_a$ [mm]	Outer width $B_a$ [mm]	Bending radii $R$ [mm]	Pitch [mm]
1400	21	ø 18	15 - 125	28	28,5 - 138,5	35 - 180
2400	25	ø 23	25 - 125	35	41 - 141	55 - 250
2600	35	ø 32	50 - 175	50	66 - 194	63 - 250
3400	45	ø 42	50 - 250	64	70 - 270	75 - 300

### E2/000, snap-open along outer radius



Series	Inner height $h_i$ [mm]	Inner width $B_i$ [mm]	Outer height $h_a$ [mm]	Outer width $B_a$ [mm]	Bending radii $R$ [mm]	Pitch [mm]
1500	21	ø 18	15 - 125	28	28,5 - 138,5	35 - 180
2500	25	ø 23	25 - 125	35	41 - 141	55 - 250
2700	35	ø 32	50 - 175	50	66 - 194	63 - 250
3500	45	ø 42	50 - 250	64	70 - 270	75 - 300
255	24	ø 22	38 - 103	35	54,2 - 119,2	55 - 250

### E2/000 "half" Energy Tube, snap-open along inner radius



Series	Inner height $h_i$ [mm]	Inner width $B_i$ [mm]	Outer height $h_a$ [mm]	Outer width $B_a$ [mm]	Bending radii $R$ [mm]	Pitch [mm]
1450	21	ø 18	15 - 125	28	28,5 - 138,5	35 - 180
2450	25	ø 23	25 - 125	35	41 - 141	55 - 250
2650	35	ø 32	50 - 175	50	66 - 194	63 - 250
3450	45	ø 42	50 - 250	64	70 - 270	75 - 300

### E2/000 enclosed E-Tube, snap-open along inner radius



Series	Inner height $h_i$ [mm]	Inner width $B_i$ [mm]	Outer height $h_a$ [mm]	Outer width $B_a$ [mm]	Bending radii $R$ [mm]	Pitch [mm]
1480	21	ø 18	38 - 50	28	51,5 - 63,5	75 - 180
2480	25	ø 23	38 - 103	35	54 - 119	100 - 250
2680	35	ø 32	50 - 100	50	66 - 116	100 - 250
3480	45	ø 42	75 - 175	64	95 - 195	125 - 300





Unsupported fill weight max [kg/m]	Unsupported length max [m]	Long travel max [m]	Opening principle	Interior separation possibilities...			ESD/AETEX	Clean-Room	UL-V2	Low noise	Price index	Page
				Separators	Full-width shelves	Shelves						
0,23	0,375	-		-	-	-	▲	○	▲	■	●●●●	5.10
0,35	0,5	-		-	-	-	▲	○	▲	●	●●●●	5.14
0,25	0,5	-		-	-	-	▲	○	▲	■	●●●●	5.18
0,375	0,55	-		-	-	-	▲	○	▲	●	●●●●	5.22
0,48	0,625	-		-	-	-	▲	○	▲	●	●●●●	5.26
0,7	1,0	-		-	-	-	▲	○	▲	●	●●●●	5.30
1,5	1,2	-		●	-	-	▲	●	▲	●	●●●●	5.40
1,5	1,5	-		-	-	-	▲	○	▲	●	●●●●	5.46
1,5	1,5	-		-	-	-	▲	○	▲	●	●●●●	5.50
1,5	1,5	-		-	-	-	▲	○	▲	●	●●●●	5.54
0,5	0,65	-		-	-	-	▲	■	▲	●	●●●●	5.58
1,5	1,2	-		●	●	-	▲	●	▲	●	●●●●	5.62
1,5	1,2	-		●	●	-	▲	○	▲	●	●●●●	5.74
1,5	1,2	-		●	●	-	▲	●	▲	●	●●●●	5.62
1,0	1,0	-		●	●	-	▲	○	▲	●	●●●●	5.68
2,5	2,0	75		●	●	-	▲	○	-	●	●●●●	5.84
5,0	2,5	100		●	●	●	▲	●	-	●	●●●●	5.94
8,0	3,25	120		●	●	●	▲	○	-	●	●●●●	5.106
13,0	3,25	150		●	●	●	▲	○	-	●	●●●●	5.118
2,5	2,0	75		●	●	-	▲	○	-	●	●●●●	5.84
5,0	2,5	100		●	●	●	▲	●	-	●	●●●●	5.94
8,0	3,25	120		●	●	●	▲	○	-	●	●●●●	5.106
13,0	3,25	150		●	●	●	▲	○	-	●	●●●●	5.118
2,0	1,8	100		●	●	●	▲	●	-	■	●●●●	5.130
2,5	2,0	75		●	●	-	▲	○	-	●	●●●●	5.84
5,0	2,5	100		●	●	▲	▲	○	-	●	●●●●	5.94
8,0	3,25	120		●	●	●	▲	○	-	●	●●●●	5.106
13,0	3,25	150		●	●	▲	▲	○	-	●	●●●●	5.118
2,5	2,0	75		●	●	-	▲	○	-	○	●●●●	5.84
5,0	2,5	100		●	●	▲	▲	○	-	○	●●●●	5.94
8,0	3,25	120		●	●	●	▲	○	-	○	●●●●	5.106
13,0	3,25	150		●	●	▲	▲	○	-	○	●●●●	5.118

# E2 E-Tubes and E4/00

## Legend

- Standard
- Suitable to only a limited extent
- ▲ Options
- Especially suitable
- \* In preparation / on request

Series

Inner height  
 $h_i$  [mm]  
ø cable max.



Inner width  
 $B_i$  [mm]  
from - to



Outer height  
 $h_a$  [mm]



Outer width  
 $B_a$  [mm]  
from - to



Bending radii  
 $R$  [mm]  
from - to



Pitch  
[mm]



## E2 R100 - two-piece E-Tube - hinged lids

### E2 E-Tubes, hinged, snap-open along inner radius



Series	Inner height $h_i$ [mm]	Inner width $B_i$ [mm]	Outer height $h_a$ [mm]	Outer width $B_a$ [mm]	Bending radii $R$ [mm]	Pitch [mm]	
R117	21	ø 17	20 - 100	28	32 - 112	63 - 180	30,5
R157	40	ø 37	40 - 200	50	56 - 216	100 - 250	46
R167	50	ø 46	50 - 250	64	68 - 268	100 - 300	58,8

### E2 E-Tubes, hinged, snap-open along outer radius



Series	Inner height $h_i$ [mm]	Inner width $B_i$ [mm]	Outer height $h_a$ [mm]	Outer width $B_a$ [mm]	Bending radii $R$ [mm]	Pitch [mm]	
R118	21	ø 17	20 - 100	28	32 - 112	63 - 180	30,5
R158	40	ø 37	40 - 200	50	56 - 216	100 - 250	46
R168	50	ø 46	50 - 250	64	68 - 268	100 - 300	58,8

## E2 R - two-piece E-Tubes - small pitch

### E4/00, with crossbars every link

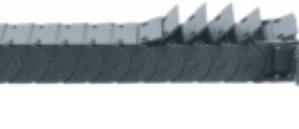

Series	Inner height $h_i$ [mm]	Inner width $B_i$ [mm]	Outer height $h_a$ [mm]	Outer width $B_a$ [mm]	Bending radii $R$ [mm]	Pitch [mm]	
R48	25	ø 22	25 - 130	36	36 - 141	60 - 250	30,3
R58	35	ø 32	50 - 200	50	66 - 216	75 - 250	33,3
R68	45	ø 42	50 - 250	64	68 - 268	100 - 300	36

## E4/00 - the standard - E4 modular system

### E4/00, with crossbars every link



Series	Inner height $h_i$ [mm]	Inner width $B_i$ [mm]	Outer height $h_a$ [mm]	Outer width $B_a$ [mm]	Bending radii $R$ [mm]	Pitch [mm]	
210	21	ø 18	30 - 120	28	44 - 134	38 - 200	30,5
220	28	ø 25	40 - 300	42	60 - 320	55 - 250	46
280	32	ø 28	50 - 400	54	73 - 423	63 - 300	56
380	42	ø 38	50 - 400	64	76 - 426	75 - 350	67
400	56	ø 50	50 - 600	84	84 - 634	135 - 500	91
600	108	ø 97	200 - 600	140	252 - 652	200 - 1000	143
640	112	ø 100	87 - 562	140	139 - 614	200 - 1000	143
800	200	ø 184	200 - 600	236	260 - 660	325 - 1000	250
840	204	ø 184	100 - 563	236	160 - 623	325 - 1000	250

### E4/00, with crossbars every other link



Series	Inner height $h_i$ [mm]	Inner width $B_i$ [mm]	Outer height $h_a$ [mm]	Outer width $B_a$ [mm]	Bending radii $R$ [mm]	Pitch [mm]	
290	32	ø 28	50 - 400	54	73 - 423	63 - 300	56
390	42	ø 38	50 - 400	64	76 - 426	75 - 350	67
410	56	ø 50	50 - 600	84	84 - 634	135 - 500	91
601	108	ø 97	200 - 600	140	252 - 652	200 - 1000	143

### E4/00, E-Tube - fully enclosed



Series	Inner height $h_i$ [mm]	Inner width $B_i$ [mm]	Outer height $h_a$ [mm]	Outer width $B_a$ [mm]	Bending radii $R$ [mm]	Pitch [mm]	
R760	28	ø 25	50 - 300	42	70 - 320	63 - 250	46
R770	32	ø 28	50 - 300	54	73 - 323	125 - 300	56
R780	42	ø 38	50 - 300	64	76 - 326	125 - 350	67
R880	56	ø 50	75 - 462	84	109 - 497	150 - 500	91
R608	108	ø 97	200 - 400	140	252 - 452	250 - 1000	143



Unsupported fill weight max [kg/m]



Unsupported length max [m]



Long travel max [m]



Opening principle



Interior separation possibilities...

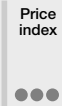
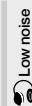
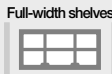

Page

Unsupported fill weight max [kg/m]	Unsupported length max [m]	Long travel max [m]	Opening principle	Separators	Full-width shelves	Shelves	ESD/ATEX	Clean-Room	UL-V2	Low noise	Price index	Page
1,5	1,2	-	 Snap-open along inner radius	●	-	-	▲	○	-	○	●●●	6.6
8,0	2,25	-		●	▲	-	▲	○	-	○	●●●	6.12
10,0	2,5	-		●	▲	-	▲	○	-	○	●●●	6.20

1,5	1,2	-	 Snap-open along outer radius	●	-	-	▲	○	-	○	●●●	6.6
8,0	2,25	-		●	▲	-	▲	○	-	○	●●●	6.12
10,0	2,5	-		●	▲	-	▲	○	-	○	●●●	6.20

1,0	1,5	-	 Lids to open from outer radius	●	▲	-	▲	○	-	●	●●●	6.26
8,0	2,3	-		●	●	●	▲	○	-	●	●●●	6.34
10,0	2,5	-		●	●	●	▲	○	-	●	●●●	6.42

4,0	2,6	120	 To open from both sides	●	●	-	▲	●	-	■	●●●	7.12
8,0	2,75	200		●	●	●	▲	●	-	■	●●●	7.18
10,0	3,5	200		●	-	●	▲	●	-	■	●●●	7.26
30,0	3,8	300		●	-	●	▲	○	-	■	●●●	7.36
48,0	4,5	400		●	-	●	▲	○	-	■	●●●	7.46
65,0	7,0	450		●	-	●	▲	○	-	■	●●●	7.56
65,0	7,0	450		●	-	●	▲	○	-	■	●●●	7.64
90,0	8,0	450		●	-	●	▲	○	-	■	●●●	7.74
90,0	8,0	450		●	-	-	▲	○	-	■	●●●	7.80

10,0	3,5	200	 To open from both sides	●	-	●	▲	●	-	■	●●●	7.26
30,0	3,8	300		●	-	●	▲	○	-	■	●●●	7.36
48,0	4,5	400		●	-	●	▲	○	-	■	●●●	7.46
65,0	7,0	450		●	-	●	▲	○	-	■	●●●	7.56

8,0	2,75	200	 Lids can be hinge-opened	●	●	●	▲	○	-	■	●●●	7.18
10,0	3,5	200		●	-	●	▲	○	-	■	●●●	7.26
30,0	3,8	300		●	-	●	▲	○	-	■	●●●	7.36
48,0	4,5	400		●	-	●	▲	○	-	■	●●●	7.46
65,0	7,0	450		●	-	●	▲	○	-	■	●●●	7.56

# E4/4 and E4/light

## Legend

- Standard
- Suitable to only a limited extent
- ▲ Options
- Especially suitable
- \* In preparation / on request

Series

Inner height  
 $h_i$  [mm]  
ø cable max.



Inner width  
 $B_i$  [mm]  
from - to



Outer height  
 $h_a$  [mm]



Outer width  
 $B_a$  [mm]  
from - to



Bending radii  
 $R$  [mm]  
from - to



Pitch  
[mm]



## E4/4 - speciality: High stability side mounted - very long travels

### E4/4 - with crossbars every link



Series	Inner height $h_i$ [mm]	Inner width $B_i$ [mm]	Outer height $h_a$ [mm]	Outer width $B_a$ [mm]	Bending radii $R$ [mm]	Pitch [mm]	
2828	32	ø 28	50 - 400	54	73 - 423	63 - 300	56
3838	42	ø 38	50 - 400	64	77 - 427	75 - 350	67
4040	56	ø 50	50 - 600	84	86 - 636	135 - 500	91
5050	80	ø 74	50 - 600	108	100 - 650	150 - 1000	91

### E4/4 HD - "Heavy Duty" - with crossbars every link - very sturdy



4040HD	56	ø 50	50 - 600	84	104 - 654	135 - 300	91
5050HD	80	ø 74	50 - 600	108	110 - 660	200 - 500	91

### E4/4 - with crossbars every other link



2928	32	ø 28	50 - 400	54	73 - 423	63 - 300	56
3938	42	ø 38	50 - 400	64	77 - 427	75 - 350	67
4140	56	ø 50	50 - 600	84	86 - 636	135 - 500	91
5150	80	ø 74	50 - 600	108	100 - 650	150 - 1000	91

### E4/4 - E-Tube - fully enclosed



R7728	32	ø 28	50 - 300	54	73 - 323	125 - 300	56
R7838	42	ø 38	50 - 300	64	77 - 327	125 - 350	67
R8840	56	ø 50	75 - 462	84	111 - 499	150 - 500	91
R9850	80	ø 74	75 - 462	108	125 - 513	200 - 1000	91

### E4/4 HD - "Heavy Duty" E-Tube - fully enclosed - very sturdy



R8840HD	56	ø 50	75 - 462	84	129 - 516	150 - 300	91
R9850HD	80	ø 74	75 - 462	108	135 - 522	200 - 500	91

## E4/light - speciality: Light weight - low price

### E4/light - with crossbars every other link



14040	56	ø 50	50 - 600	84	76 - 626	135 - 500	91
14240	62	ø 56	50 - 400	84	76 - 426	135 - 500	91
15050	80	ø 74	50 - 600	108	80 - 630	150 - 500	91
1640	112	ø 100	50 - 600	140	84 - 634	200 - 600	143

### E4/light - with crossbars every link



14140	56	ø 50	50 - 600	84	76 - 626	135 - 500	91
14340	62	ø 56	50 - 400	84	76 - 426	135 - 500	91
15150	80	ø 74	50 - 600	108	80 - 630	150 - 500	91

### E4/light E-Tube - fully enclosed



R18840	56	ø 50	75 - 462	84	101 - 489	150 - 500	91
R19850	80	ø 74	75 - 462	108	105 - 493	200 - 500	91
R1608	112	ø 100	200 - 400	140	234 - 434	250 - 600	143

Unsupported fill weight max [kg/m]



Unsupported length max [m]



Long travel max [m]



Opening principle



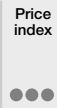
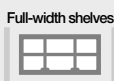

Interior separation possibilities...





Page

10,0	3,5	200	 To open from both sides	●	–	●	▲■	○	–	●	●●●●	7.82
30,0	3,8	280		●	–	●	▲■	○	–	●	●●●●	7.104
48,0	4,5	300		●	–	●	▲■	○	–	●	●●●●	7.116
60,0	6,0	400		●	–	●	▲■	○	–	●	●●●●	7.136

50,0	4,5	> 300	 To open from both sides	●	–	●	▲■	○	–	●	●●●●	7.128
60,0	6,0	> 400		●	–	●	▲■	○	–	●	●●●●	7.148

10,0	3,5	200	 To open from both sides	●	–	●	▲■	○	–	●	●●●●	7.92
30,0	3,8	280		●	–	●	▲■	○	–	●	●●●●	7.104
48,0	4,5	300		●	–	●	▲■	○	–	●	●●●●	7.116
60,0	6,0	400		●	–	●	▲■	○	–	●	●●●●	7.136

10,0	3,5	200	 Lids can be hinge-opened	●	–	●	▲■	○	–	●	●●●●	7.82
30,0	3,8	280		●	–	●	▲■	○	–	●	●●●●	7.104
48,0	4,5	300		●	–	●	▲■	○	–	●	●●●●	7.116
50,0	4,5	400		●	–	●	▲■	○	–	●	●●●●	7.136

48,0	4,5	> 300	 Lids can be hinge-opened	●	–	●	▲■	○	–	●	●●●●	7.128
50,0	4,5	> 400		●	–	●	▲■	○	–	●	●●●●	7.148

40,0	4,0	150	 To open from both sides	●	–	●	▲■	○	–	●	●●●●	7.162
40,0	4,0	150		●	–	●	▲■	○	–	●	●●●●	7.172
55,0	4,5	250		●	–	●	▲■	○	–	●	●●●●	7.182
50,0	4,5	400		●	–	●	▲■	○	–	●	●●●●	7.194

40,0	4,0	150	 To open from both sides	●	–	●	▲■	○	–	●	●●●●	7.162
40,0	4,0	150		●	–	●	▲■	○	–	●	●●●●	7.172
55,0	4,5	250		●	–	●	▲■	○	–	●	●●●●	7.182

40,0	4,0	150	 Lids can be hinge-opened	●	–	●	▲■	○	–	●	●●●●	7.162
55,0	4,5	250		●	–	●	▲■	○	–	●	●●●●	7.182
50,0	4,5	400		●	–	●	▲■	○	–	●	●●●●	7.194



# E3, T3 and E6

## Legend

- Standard
- Suitable to only a limited extent
- ▲ Options
- Especially suitable
- \* In preparation / on request

Series

Inner height  
 $h_i$  [mm]  
ø cable max.



Inner width  
 $B_i$  [mm]  
from - to



Outer height  
 $h_a$  [mm]



Outer width  
 $B_a$  [mm]  
from - to



Bending radii  
 $R$  [mm]  
from - to



Pitch  
[mm]



## E3 - 3-piece E-Chain®, small, high dynamics - smooth and low noise

### E3 E-Chain®, zip open lids



Series	Inner height $h_i$ [mm]	Inner width $B_i$ [mm]	Outer height $h_a$ [mm]	Outer width $B_a$ [mm]	Bending radii $R$ [mm]	Pitch [mm]	
E3.10	10	ø 8	20 - 60	15	32 - 72	15 - 48	16,7
E3.15	15	ø 13	20 - 60	20	32 - 72	32 - 75	16,7
E3.22	22	ø 20	20 - 60	27	32 - 72	44 - 75	16,7

## T3 - 3-piece t-profile E-Chain® - very lightweight and quiet

### T3 E-Chain®, to open from both sides



Series	Inner height $h_i$ [mm]	Inner width $B_i$ [mm]	Outer height $h_a$ [mm]	Outer width $B_a$ [mm]	Bending radii $R$ [mm]	Pitch [mm]	
T3.29	29	ø 25	30 - 120	35	55 - 145	38	15

## E6 -6-piece E-Chain® - for extremely low-noise operations

### E6 E-Chain®, crossbars every other link



Series	Inner height $h_i$ [mm]	Inner width $B_i$ [mm]	Outer height $h_a$ [mm]	Outer width $B_a$ [mm]	Bending radii $R$ [mm]	Pitch [mm]	
E6.29	29	ø 25	30 - 120	35	46 - 136	55 - 150	22
E6.35	35	ø 31	30 - 120	42	50 - 140	55 - 150	25
E6.40	40	ø 36	40 - 300	54	60 - 320	63 - 200	27,8
E6.52	52	ø 46	40 - 300	65	64 - 324	75 - 250	30
E6.62	62	ø 54	50 - 400	84	86 - 436	115 - 350	50
E6.80L	80	ø 72	112 - 550	108	140 - 578	150 - 450	65
E6.80	80	ø 72	50 - 600	108	100 - 650	150 - 450	65

### E6 E-Tube - fully enclosed



Series	Inner height $h_i$ [mm]	Inner width $B_i$ [mm]	Outer height $h_a$ [mm]	Outer width $B_a$ [mm]	Bending radii $R$ [mm]	Pitch [mm]	
R6.29	29	ø 25	30 - 120	35	46 - 136	55 - 150	22
R6.40	40	ø 36	62	54	82	63 - 200	27,8
R6.52	52	ø 46	40 - 300	65	64 - 324	75 - 250	30



Unsupported fill weight max [kg/m]	Unsupported length max [m]	Long travel max [m]	Opening principle	Interior separation possibilities...			ESD/ATEX	Clean-Room IP23	UL-V2	Low noise	Price index	Page
				Separators	Full-width shelves	Shelves						

0,30	0,75	-	 Zip-open	●	-	-	▲	■	▲	■	●●●	8.10
0,70	0,9	-		●	▲	-	▲	■	▲	■	●●●	8.14
0,85	1,2	-		●	▲	-	▲	■	▲	■	●●●	8.18

1,0	1,0	-	 To open from both sides	●	●	●	▲	■	▲	■	●●●	8.22

3,0	1,7	-	 To open from both sides	●	●	●	▲	■	▲	■	●●●	8.40
6,0	1,9	-		●	●	●	▲	■	▲	■	●●●	8.50
10,0	2,75	60		●	●	●	▲	■	▲	■	●●●	8.56
15,0	3,0	80		●	●	●	▲	■	▲	■	●●●	8.66
43,0	4,0	100		●	●	●	▲	■	▲	■	●●●	8.76
25,0	2,5	-		●	-	●	▲	■	▲	■	●●●	8.82
55,0	5,3	120		●	-	●	▲	■	▲	■	●●●	8.88

3,0	1,7	-	 Lids can be removed on both sides	●	-	-	▲	■	▲	■	●●●	8.46
10,0	2,75	60		●	-	-	▲	■	▲	■	●●●	8.62
15,0	3,0	80		●	-	-	▲	■	▲	■	●●●	8.72

# Classic Series

## Legend

- Standard
- Suitable to only a limited extent
- ▲ Options
- Especially suitable
- \* In preparation / on request

## Series

Inner height  
 $h_i$  [mm]  
ø cable max.



Inner width  
 $B_i$  [mm]  
from - to



Outer height  
 $h_a$  [mm]



Outer width  
 $B_a$  [mm]  
from - to



Bending radii  
 $R$  [mm]  
from - to



Pitch  
[mm]



## Zipper Classic E-Chains® - lightning-fast opening and closing

Zipper, zip-open along the **outer** radius



Series	Inner height $h_i$ [mm]	Inner width $B_i$ [mm]	Outer height $h_a$ [mm]	Outer width $B_a$ [mm]	Bending radii $R$ [mm]	Pitch [mm]	
15 Classic	17	ø 15	15 - 50	24	26 - 61	38 - 180	30,5

## E2 mini Classic - one/two-piece E-Chains® - small and medium sizes

E2 mini, non snap-open



Series	Inner height $h_i$ [mm]	Inner width $B_i$ [mm]	Outer height $h_a$ [mm]	Outer width $B_a$ [mm]	Bending radii $R$ [mm]	Pitch [mm]	
10 Classic	18	ø 16	15 - 50	23	26 - 61	28 - 180	30,5

E2 mini, snap-open along **outer** radius



Series	Inner height $h_i$ [mm]	Inner width $B_i$ [mm]	Outer height $h_a$ [mm]	Outer width $B_a$ [mm]	Bending radii $R$ [mm]	Pitch [mm]	
B15 Classic	17	ø 14	15 - 50	24	26 - 61	38 - 180	30,5

## E2 medium Classic - for new constructions please use E2/000

E2 medium, closed design



Series	Inner height $h_i$ [mm]	Inner width $B_i$ [mm]	Outer height $h_a$ [mm]	Outer width $B_a$ [mm]	Bending radii $R$ [mm]	Pitch [mm]	
200 Classic	25	ø 23	25 - 125	35	41 - 141	55 - 250	46
26 Classic	35	ø 32	50 - 200	50	66 - 219	63 - 250	56
20 Classic	25	ø 23	11 - 103	34	27 - 118	55 - 250	46
30 Classic	45	ø 42	75 - 175	64	93 - 195	75 - 300	67

E2 medium, snap-open along **inner** radius

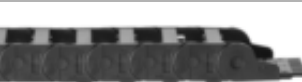

Series	Inner height $h_i$ [mm]	Inner width $B_i$ [mm]	Outer height $h_a$ [mm]	Outer width $B_a$ [mm]	Bending radii $R$ [mm]	Pitch [mm]	
240 Classic	25	ø 23	25 - 125	35	41 - 141	55 - 250	46
27i Classic	35	ø 32	50 - 200	50	66 - 219	63 - 250	56
340 Classic	45	ø 42	50 - 250	64	70 - 270	75 - 300	67
36 Classic	45	ø 42	75 - 175	64	93 - 195	75 - 300	67

E2 medium, snap-open along **outer** radius









Series	Inner height $h_i$ [mm]	Inner width $B_i$ [mm]	Outer height $h_a$ [mm]	Outer width $B_a$ [mm]	Bending radii $R$ [mm]	Pitch [mm]	
250 Classic	25	ø 23	25 - 125	35	41 - 141	55 - 250	46
27 Classic	35	ø 32	50 - 200	50	66 - 219	63 - 250	56
350 Classic	45	ø 42	50 - 250	64	70 - 270	75 - 300	67
25 Classic	25	ø 23	11 - 103	34	27 - 118	55 - 250	46
35 Classic	45	ø 42	75 - 175	64	93 - 195	75 - 300	67

## E2 R Classic - two-piece E-Tubes - small pitch

E2 R Classic, snap-open along **outer** radius



Series	Inner height $h_i$ [mm]	Inner width $B_i$ [mm]	Outer height $h_a$ [mm]	Outer width $B_a$ [mm]	Bending radii $R$ [mm]	Pitch [mm]	
R58 Classic	35	ø 32	50 - 75	50	66 - 92	75 - 250	33,3
R68 Classic	45	ø 42	75 - 175	64	93 - 196	100 - 300	36

Unsupported fill weight max [kg/m]	Unsupported length max [m]	Long travel max [m]	Opening principle	Interior separation possibilities...			ESD/ATEX	Clean-Room	UL-V2	Low noise	Price index	Page
				Separators	Full-width shelves	Shelves						
1,5	1,2	-	 Zip-open	●	-	-	-	-	-	-	●●●	12.4
1,5	1,2	-	 Closed	-	-	-	▲	●	▲	●	●●●	12.6
1,5	1,2	-	 Snap-open along outer radius	●	-	-	▲	●	▲	●	●●●	12.8
4,0	2,0	100	 Closed	●	●	●	-	-	-	-	●●●	12.10
8,0	2,2	120		●	●	●	-	-	-	-	●●●	12.12
4,0	2,0	-		●	●	-	-	-	-	-	●●●	12.18
10,0	2,5	-		●	●	-	-	-	-	-	●●●	12.20
4,0	2,0	100	 Snap-open along inner radius	●	●	●	-	-	-	-	●●●	12.10
8,0	2,2	120		●	●	●	-	-	-	-	●●●	12.12
10,0	2,5	150		●	●	●	-	-	-	-	●●●	12.14
10,0	2,5	-		●	●	-	-	-	-	-	●●●	12.20
4,0	2,0	100	 Snap-open along outer radius	●	●	●	-	-	-	-	●●●	12.10
8,0	2,2	120		●	●	●	-	-	-	-	●●●	12.12
10,0	2,5	150		●	●	●	-	-	-	-	●●●	12.14
4,0	2,0	-		●	●	-	-	-	-	-	●●●	12.18
10,0	2,5	-	●	●	-	-	-	-	-	●●●	12.20	
8,0	2,3	-	 Lids to open from outer radius	●	●	-	-	-	-	-	●●●	12.22
10,0	2,50	-		●	●	-	-	-	-	-	●●●	12.24

# Classic Series

## Legend

- Standard
- Suitable to only a limited extent
- ▲ Options
- Especially suitable
- \* In preparation / on request

Series	Inner height <i>hi</i> [mm] ø cable max.	Inner width <i>Bi</i> [mm] from - to	Outer height <i>ha</i> [mm]	Outer width <i>Ba</i> [mm] from - to	Bending radii <i>R</i> [mm] from - to	Pitch [mm]

## E4/light Classic - for new applications please use E4/light

### E4/light, with crossbars every link



140 Classic	<b>56</b>	ø 50	50 - 600	84	76 - 626	135 - 500	91
142 Classic	<b>62</b>	ø 56	50 - 400	84	76 - 426	135 - 500	91
150 Classic	<b>80</b>	ø 74	50 - 600	108	80 - 630	150 - 500	91

### E4/light, with crossbars every other link



141 Classic	<b>56</b>	ø 50	50 - 600	84	76 - 626	135 - 500	91
143 Classic	<b>62</b>	ø 56	50 - 400	84	76 - 426	135 - 500	91
151 Classic	<b>80</b>	ø 74	50 - 600	108	80 - 630	150 - 500	91

### E4/light E-Tube - fully enclosed



R188 Classic	<b>56</b>	ø 50	75 - 462	84	101 - 489	150 - 500	91
R198 Classic	<b>80</b>	ø 74	75 - 462	108	105 - 493	200 - 500	91

## E4/0 Classic - for new constructions please use E4/00

### E4/0, with crossbars every link



22 Classic	<b>28</b>	ø 25	40 - 300	42	60 - 320	55 - 250	46
28 Classic	<b>32</b>	ø 28	50 - 400	54	73 - 423	63 - 300	56
38 Classic	<b>42</b>	ø 38	50 - 400	64	77 - 427	75 - 350	67
40 Classic	<b>56</b>	ø 50	50 - 600	84	86 - 636	135 - 500	91
50 Classic	<b>80</b>	ø 74	50 - 600	108	100 - 650	150 - 1000	91

### E4/0, with crossbars every other link



23 Classic	<b>28</b>	ø 25	40 - 300	42	60 - 320	55 - 250	46
29 Classic	<b>32</b>	ø 28	50 - 400	54	73 - 423	63 - 300	56
39 Classic	<b>42</b>	ø 38	50 - 400	64	77 - 427	75 - 350	67
41 Classic	<b>56</b>	ø 50	50 - 600	84	86 - 636	135 - 500	91
51 Classic	<b>80</b>	ø 74	50 - 600	108	100 - 650	150 - 1000	91

### E4/0 E-Tube - fully enclosed



R76 Classic	<b>28</b>	ø 25	50 - 300	42	70 - 320	75 - 250	46
R77 Classic	<b>32</b>	ø 28	50 - 300	54	73 - 323	125 - 300	56
R78 Classic	<b>42</b>	ø 38	50 - 300	64	77 - 327	125 - 350	67
R88 Classic	<b>56</b>	ø 50	75 - 462	84	111 - 499	150 - 500	91
R98 Classic	<b>80</b>	ø 74	75 - 462	108	125 - 513	200 - 1000	91

## Line Extensions and special solutions

### Versions with increased inner height - based on Series 380 / 3838 / 38, with crossbars every link















38022 E4/00	<b>52</b>	ø 48	50 - 400	64	76 - 426	75 - 350	67
383822 E4/4	<b>52</b>	ø 48	50 - 400	64	77 - 427	75 - 350	67
3822 E4/0	<b>52</b>	ø 48	50 - 400	64	77 - 427	75 - 350	67

### Series E-Band



E-Band	<b>25,5</b>	ø 22	25	36	36	45 - 200	25
--------	-------------	------	----	----	----	----------	----



Unsupported fill weight max [kg/m]	Unsupported length max [m]	Long travel max [m]	Opening principle	Interior separation possibilities...			ESD/ATEX 	Clean-Room 	UL-V2 	Low noise 	Price index	Page
				Separators	Full-width shelves	Shelves						
40,0	4,0	150		●	–	●	–	–	–	–	●●●	12.26
40,0	4,0	150		●	–	●	–	–	–	–	●●●	12.28
50,0	4,5	250		●	–	●	–	–	–	–	●●●	12.30
40,0	4,0	150		●	–	●	–	–	–	–	●●●	12.26
40,0	4,0	150		●	–	●	–	–	–	–	●●●	12.28
50,0	4,5	250		●	–	●	–	–	–	–	●●●	12.30
40,0	4,0	150		●	–	●	–	–	–	–	●●●	12.26
50,0	4,5	250		●	–	●	–	–	–	–	●●●	12.30
8,0	2,1	150		●	●	●	–	–	–	–	●●●	12.32
10,0	2,5	200		●	–	●	–	–	–	–	●●●	12.36
30,0	3,25	280		●	–	●	–	–	–	–	●●●	12.36
50,0	4,5	350		●	–	●	–	–	–	–	●●●	12.38
60,0	6,0	300		●	–	●	–	–	–	–	●●●	12.40
8,0	2,1	150		●	●	●	–	–	–	–	●●●	12.32
10,0	2,5	200		●	–	●	–	–	–	–	●●●	12.34
30,0	3,25	280		●	–	●	–	–	–	–	●●●	12.36
50,0	4,5	350		●	–	●	–	–	–	–	●●●	12.38
60,0	6,0	300		●	–	●	–	–	–	–	●●●	12.40
8,0	2,1	150		●	●	●	–	–	–	–	●●●	12.32
10,0	2,5	200		●	–	●	–	–	–	–	●●●	12.34
30,0	3,25	280		●	–	●	–	–	–	–	●●●	12.36
50,0	4,5	350		●	–	●	–	–	–	–	●●●	12.38
60,0	6,0	300		●	–	●	–	–	–	–	●●●	12.40
30,0	3,8	300		●	–	●	▲	○	–	■	●●●	12.42
30,0	3,8	280		●	–	●	▲■	○	–	●	●●●	12.44
30,0	3,25	280		●	–	●	–	–	–	–	●●●	12.46
1,5	1,5	–		–	–	–	▲	●	–	●	●●●	12.50

# igus® guide troughs - for long travels

Guide troughs  
for long travels

Series

Outer height  
Trough side  
part [mm]

Can be used in the following igus® E-ChainSystems®  
Zipper

E2  
mini

System  
E2/000

Tubes  
E2



## Super-alu-trough, basic version - for general machinery



970.30.SL / 970.31.SL	<b>77</b>	15/R15	10/B15	–	–
970.30.SL / 970.32.SL	<b>77</b>	–	–	2400/1450/1480/1500	–
971.30.SL / 971.31.SL	<b>87</b>	–	–	2400/2450/2480/2500/255	R48
972.02.30.SL / 972.02.31.SL	<b>117</b>	–	–	–	–
972.30.SL / 972.31.SL	<b>117</b>	–	–	–	–
972.30.SL / 972.32.SL	<b>117</b>	–	–	2600/2650/2680/2700	R58
973.30.SL / 973.31.SL	<b>144</b>	–	–	3400/3450/3480/3500	R68
974.30.SL / 974.31.SL	<b>184</b>	–	–	–	–
975.30.SL / 975.31.SL	<b>236</b>	–	–	–	–
<b>Heavy Duty Version</b>					
974.30.SL / 974.31.SL	<b>184</b>	–	–	–	–
975.30.SL / 975.31.SL	<b>236</b>	–	–	–	–

## Speciality: Steel guide trough - for harsh environments



92.30 / 92.31	<b>70</b>	–	–	2400/2450/2480/2500/255	–
95.30 / 95.31	<b>100</b>	–	–	2600/2650/2680/2700	R58
99.30 / 99.31	<b>100</b>	–	–	–	–
97.30 / 97.31	<b>130</b>	–	–	–	–
93.30 / 93.31	<b>130</b>	–	–	3400/3450/3480/3500	R68
94.30 / 94.31	<b>170</b>	–	–	–	–
96.30 / 96.31	<b>220</b>	–	–	–	–
98.30 / 98.31	<b>300</b>	–	–	–	–
90.30 / 90.31	<b>480</b>	–	–	–	–
91.10 - 91.51	<b>48</b>	15/R15	10/B15	–	–

## Speciality: Tubular trough system RS - lets light and chips through

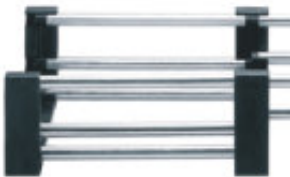

92.70 / 92.71	<b>90</b>	–	–	2400/2450/2480/2500/255	–
93.70 / 93.71	<b>146</b>	–	–	3400/3450/3480/3500	–
95.70 / 95.71	<b>126,3</b>	–	–	2600/2650/2680/2700	–

## Speciality: Snap-in trough system SP - simple and cost effective



91.930	<b>55,5</b>	–	10/15/B15	–	–
92.930	<b>76,6</b>	–	–	2400/2450/2480/2500	–
93.930	<b>138,6</b>	–	–	3400/3450/3480/3500	–
95.930	<b>106,6</b>	–	–	2600/2650/2680/2700	–

System E4/00	System E4/4	System E4/light	System E6	Materials of side parts	Price index ●●●	Page
-	-	-	-	Aluminum	●●●	9.20
210	-	-	-	Aluminum	●●●	9.22
-	-	-	E6.29/R6.29	Aluminum	●●●	9.24
220/R760	-	-	E6.35	Aluminum	●●●	9.26
280/290/R770	2828/2928/R7728	-	E6.40/R6.40	Aluminum	●●●	9.28
-	-	-	-	-	●●●	9.30
380/390/R780	3838/3938/R7838	-	E6.52/R6.52	-	●●●	9.32
400/410/R880	4040/4140/R8840	14040/14140/R18840/14240/14340	E6.62	-	●●●	9.34
-	5050/5150/R9850	15050/15150/R19850	E6.80/E6.80L	-	●●●	9.38
-	4040HD/R8840HD	-	-	-	●●●	9.36
-	5050HD/R9850HD	-	-	-	●●●	9.40
-	-	-	E6.29/R6.29	Galvanized steel**	●●●	9.44
-	-	-	-	Galvanized steel**	●●●	9.46
220/R760	-	-	E6.35	Galvanized steel**	●●●	9.48
280/290/R770	2828/2928/R7728	-	E6.40/R6.40	Galvanized steel**	●●●	9.50
380/390/R780	3838/3938/R7838	-	E6.52/R6.52	Galvanized steel**	●●●	9.52
400/410/R880	4040/4140/R8840	14040/14140/14240/14340/R18840	E6.62	Galvanized steel**	●●●	9.54
-	5050/5150/R9850	15050/15150/R19850	E6.80/E6.80L	Galvanized steel**	●●●	9.56
600/601/R608/640	-	1640/R1608	-	Galvanized steel**	●●●	9.58
800/840	-	-	-	Galvanized steel**	●●●	9.60
-	-	-	-	-	●●●	9.63
				**Stainless steel on request		
-	-	-	E6.29/R6.29	***	●●●	9.66
-	-	-	E6.52/R6.52*	***	●●●	9.67
-	-	-	-	***	●●●	9.67
			* without spacer plate	***Galvanized steel / Polymer		
-	-	-	-	Galvanized steel***	●●●	9.68
-	-	-	E6.29/R6.29 *	Galvanized steel***	●●●	9.68
-	-	-	E6.52/R6.52	Galvanized steel***	●●●	9.69
-	-	-	-	Galvanized steel***	●●●	9.69
			* without spacer plate	***Stainless steel on request		

# Chainfix - strain relief

igus® - strain relief

Product

Ø [mm]  
from - to

Page

## Chainfix clamps and stainless-steel\* clamps- maximum pull forces



Single clamp housing, including top/bottom saddle clamps	06 - 42	10.4
Double clamp housing, incl. top/bottom saddle clamps and 1 stacker saddle clamp	06 - 34	10.4
Triple clamp housing, incl. top/bottom saddle clamps and 2 stacker saddle clamp	06 - 22	10.4
Single stainless steel*-clamp housing, including top/bottom saddle clamps	06 - 42	10.4
Double stainless steel* clamps for 2 cables incl. mating trough and double trough	06 - 34	10.4

(\*Material stainless steel: 1.4301)

## Chainfix Clip - high pull forces, plug-in



Available for all igus® E-ChainSystems with C-profiles and also suitable for assembly in the KMA mounting brackets and Clip-on strain relief for crossbars	04 - 24	10.10
--	---------	-------

## Chainfix Nugget - strain relief for small space and cables up to 20 mm o.d



Very small strain relief for the fixation of cables up to diameter of 20 mm	≤ 20	10.10
---	------	-------

## Strain relief separator with integrated teeth



Separator with integrated strain relief - easy strain relief with tie wrap		10.10
--	--	-------

## Tiewrap plates - for cable tiewrap universal, bolted or clip-on



<b>Option 1:</b> Chainfix tiewrap plates as individual parts Series 2000 and Series 3000	10.8
--	------

## Chainfix-tiewrap plates - for strain relief with cable tiewraps for C-profile



<b>Option 2:</b> Tiewrap plates with clip-on connection for the C-profile	10.9
<b>Option 3:</b> Clip-on tiewrap plates for opening or fixed crossbars	10.9
<b>Option 4:</b> integrated strain relief for E2 Tubes - Series R	10.9

Chainfix Testresults	10.7
Cable tiewraps	10.7

## igus® blocks



Blocks - Special strain relief for hoses. A Modular, space-saving system	10.11
--	-------



**Cable protection**

**Product**

**Description**

**Page**

## PMAFLEX conduits - cable protection



PACO	Flexible, medium, divisible	11.4
TN	Divisible connectors, PG	11.4
GTN	Divisible lock nuts, PG	11.4
PCL	Very flexible, medium	11.5
VOH	Pliable, very heavy	11.5
PIS/PIH	Highly flexible, medium	11.6
CYL	Very flexible, medium	11.7

## PMAFIX connectors - safety and sealing systems



IP66 - static, IP54 dynamic	Universal safety clip	11.8
IP68 - static, IP67 dynamic	Oval clip	11.8
PMAFIX	Connectors	11.9
PMAFIX Connectors VW	90° elbow, metric & PG	11.10
PMAFIX Connectors VN	Straight, metric & PG	11.11
PMAFIX Connectors VA	45° elbow, metric & PG	11.12
PMAFIX Connectors VB	90° curved elbow, metric & PG	11.13
PMAFIX Connectors VO	Flange 90°	11.13
PMAFIX FH0	One-piece system support	

## PMA - accessories

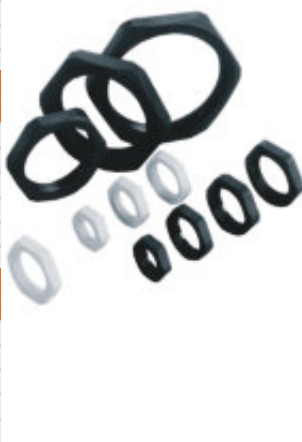

PMAFIX FH0	Hexagonal Lock Nuts, metric & PG	11.14
PMA MN	Tube clamps	11.14
PMA SGB	Plug Screws, metric & PG	11.15
PMA 514		11.15



# Pictograms - E-ChainSystems®

## Accessibility of E-Chains® and E-Tubes



Cannot be opened



Zipper principle:  
Zip to open



Snap-open  
along inner radius



Snap-open  
along outer radius



Easy Chain®-principle:  
simply press cables in



Can be opened  
from both sides



Snap-open along outer  
radius on left or right side



Snap-open along inner  
radius on left or right side



Can be opened  
from one side



Can be opened from  
both sides and hinged  
open on one side

## Pictograms



Recommended  
Standard



igus®-  
Definition



Unsupported -  
short travels



igus®-  
information



Preferred  
Series



Gliding -  
long travels



igus®  
order examples



Part No key



Vertical hanging  
application



igus® Web  
www.igus.de



Temperature



Vertical standing  
application



Weights



Acceleration /  
Speed



Side-mounted  
application



Calculation



Torsional  
movements



Rotary motion  
application



Low noise!



UL-  
Approval



Horizontal + vertical  
application



ESD-Certificate



iF-Design  
Award



Nested  
application



IPA Cleanroom-  
Certificate



Other Cleanroom-  
Certificate



Side by side  
application

## Price index



Low price category



Medium price category



Highest price category

## Icon-bar

Series

EF-FC

Inner height [mm]

80

System

System E6  
Inner height: 80 mm

Contact

Tel: +49- (0) 22 03-96 49-800  
E-mail: info@igus.de

E-Chains®

Interior separation

Mounting bracket

Strain relief

Guide though

Assembly  
instruction

Page

U

## Quicklinks

Quicklinks for more information and additional features on each page. "Visit" directly your chosen product online - for example ► [www.igus.de/en/400](http://www.igus.de/en/400) and you'll find more details, 3D-CAD-files, DXF-files, PDF-downloads, application examples and many more for your chosen igus® product.



# Selection guide - designing E-Chains®

1

## Dimensioning E-Chains®

Determine the size of the E-Chain® based on the specified installation space of your machine and/or of the selected filling (such as the number of cables/outer diameter of cable).

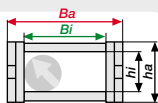

2

## Determine fill weight

Determine fill weight of (cables and/or media hoses) in [kg/m] using Chainflex® Quick Selector or manufacturer specification.

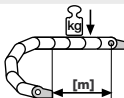

3

## Determine length of travel

Compare the fill weight calculated in (point 2) to the maximum fill weight of the selected E-Chain® and check suitability for "unsupported application".

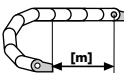

4

## Unsupported length

The maximum unsupported length initially depends on the fill weight and the E-Chain® selected. At the same time, there are three different levels of unsupported length: 1 **FL<sub>G</sub> - Recommended Range of Application** 2 **FL<sub>B</sub> - Permitted Sag** 3 **Critical Sag: Should never be operative installation!** Twice the value of the unsupported length determines the maximum travel in the "unsupported" type of operation. For evaluation the weight of the cables to be carried must be known, then an exact evaluation can be made using a diagram on the introductory page of the selected product. You will find the values for **FL<sub>G</sub>** and **FL<sub>B</sub>** in table form on the following pages of this chapter and for each Series in the catalog. They are necessary for: ● Finding the fill weight and length of travel for the appropriate E-Chain® ● Identifying the maximum load of the E-Chain® used.

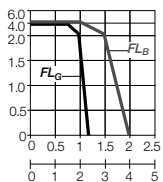
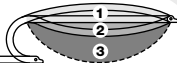

If there is suitability for "unsupported straight", then the selection follows the following criteria:

5

**Opening Principle** - The quick selection gives you an overview of the type of filling potential of the E-Chain®.



6

Determine the possible **Bending Radius R** [mm] of the E-Chain® with respect to the cable diameter.

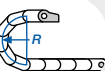

7

**Interior separation is possible with...**

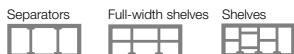

8

The **price index** gives you the possibility of making price comparisons of similar sizes within the igus® range



9

**Additional criteria** - for the appropriate selection of your E-Chains® such as pitch, permissible temperatures etc. are available under quick selection.

The following options are available if there is no possibility of self-supporting E-Chain® application:

A

You can choose the next and more stable E-Chain®, that can be operated "unsupported".

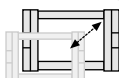

OR

B

You can design your application to be "gliding".

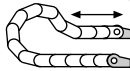

You can contact us directly or fax us your E-Chain® requests! We will respond immediately!

E-Chain® Part No: \_\_\_\_\_

Alternative E-Chain®-dimensions:

hi: \_\_\_\_\_ Bi: \_\_\_\_\_ ha: \_\_\_\_\_ Ba: \_\_\_\_\_

Fill weight: \_\_\_\_\_ kg/m

Length of travel: \_\_\_\_\_ m

Your Phone: \_\_\_\_\_

Your Fax: \_\_\_\_\_

Phone (+49) 0 22 03 - 96 49-0

Fax (+49) 0 22 03 - 96 49-222

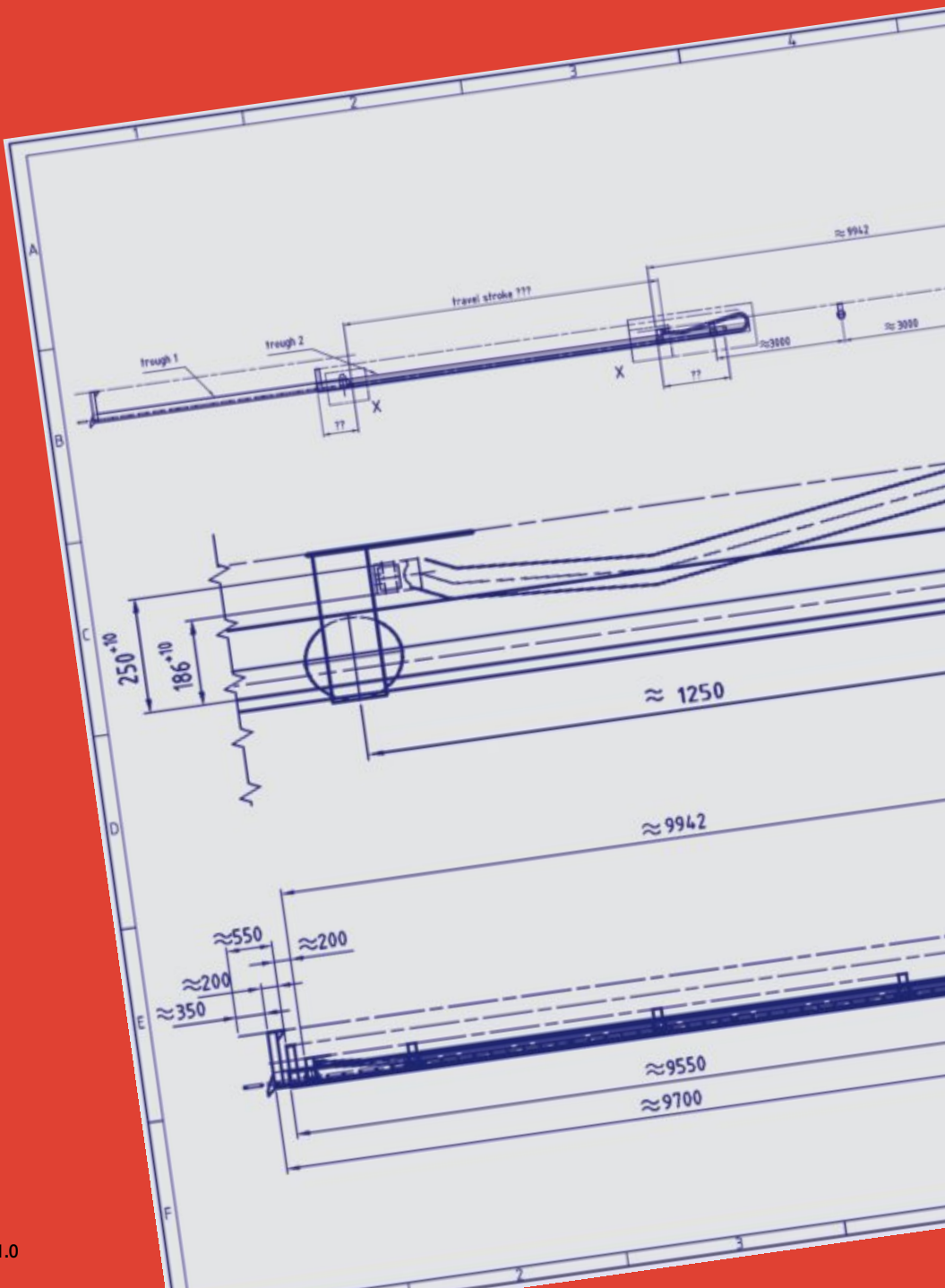

# Designing with igus<sup>®</sup>

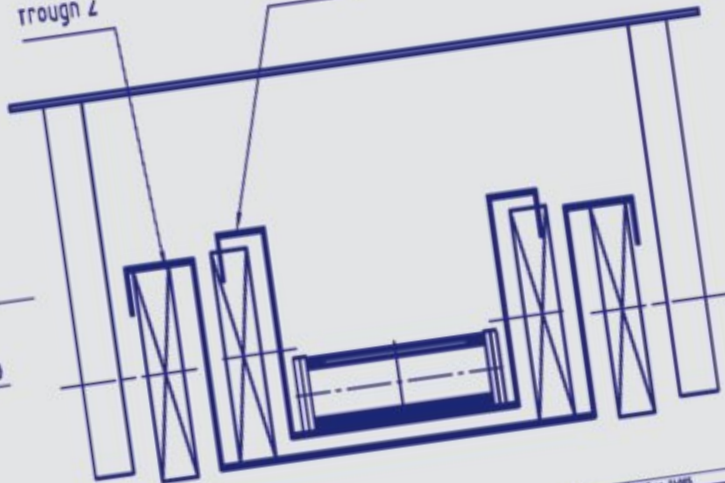

Order	Amendment	Date	Made	Design	Drawn up for	Drawn up by	CAD no. 21485
							42

**Introduction**

Introduction | **Designing with igus®** ..... page 1.3

igus® Terms | **Alphabetical Order** ..... page 1.4

Calculation | **E-Chain®-Lengths and Camber** .....page 1.5

Application-Examples | **E-ChainSystems®** .....page 1.6

**Applications**

Unsupported | **Short Travels** .....page 1.8

Unsupported | **Noise-Optimized** .....page 1.11

Load Diagrams | **Unsupported Straight  $FL_G$  | Unsupported Sag  $FL_B$**  .....page 1.12

Gliding | **Long Travels** .....page 1.16

Application | **Vertical Hanging**.....page 1.20

Application | **Vertical Hanging | Zig-Zag**.....page 1.21

Application | **Vertical Standing** .....page 1.22

Application | **Side-Mounted** .....page 1.24

Application | **Rotary Motion** .....page 1.26

**Filling and Strain Relief**

Filling | **Cable and Hose Packages** ..... page 1.28

Strain Relief Elements | **Chainfix** ..... page 1.32

**Technical Data, Standards, Material Data**

Technical Environment | **Material igumid** ..... page 1.34

Technical Environment | **ESD & ATEX** ..... page 1.35

Technical Environment | **Clean Room and ESD** ..... page 1.36

Technical Environment | **Dirty Environment** ..... page 1.37

Material | **Material Data** ..... page 1.38

Material | **Chemical Resistance and Colors** ..... page 1.39

Certifying | **Standards and Certificates** ..... page 1.40

**ReadyChains®**

ReadyChains® | **Ready-Made E-ChainSystems®** ..... page 1.41

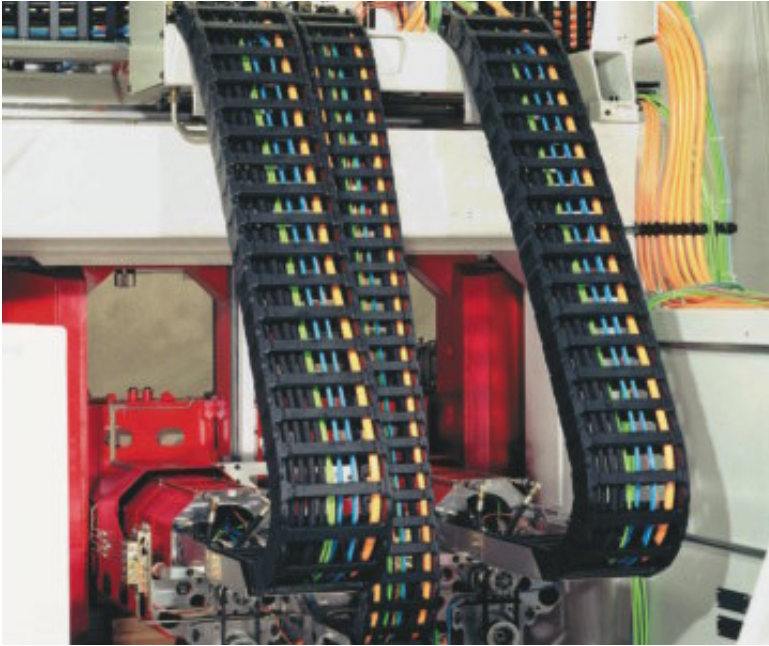

### About igus® E-ChainSystems®

igus® E-ChainSystems® guide and protect moving cables and hoses on automated equipment. They can be used in a wide variety of applications and possess the following capabilities: ● **Use with various types of motion and travels** ● **Guidance of sensitive bus and data cables, as well as FOC, using the same techniques as with electric, gas, air and liquid hose guidance** ● **Long service life under very high loads and demanding requirements** ● **Smooth operation in a full range of environments and climates**. On the following pages, we offer important guidelines which are to be taken into consideration when designing safe E-ChainSystems®. All specifications are based on test results from the igus® laboratory and our field experience since 1971. Simply fill in the "igus® system design" fax sheet or log onto the igus® web site at [igus.de](http://igus.de) and e-mail us your technical specifications, or call us. **We will provide a comprehensive quote by the end of the next business day.**

### Laboratory and practical experience

Our calculations and analyses are based on the result of ongoing practical tests in our Technical Center and our experience with gliding applications. The focal points of our tests are push-pull forces, friction values and abrasion under widely varying conditions and speeds, as well as factors such as dirt, weathering or impact and bumps. We test all system components such as cables, hoses, strain relief and other accessories, in addition to the E-Chains® or E-Tubes and Guide Troughs.



The igus® test laboratory for E-Chains® and Chainflex® cables



**Application-Icons**



Unsupported - short travels



Gliding - long travels



Vertical hanging



Vertical standing



Side-mounted



Rotary motion



Horizontal and vertical



Nested



Side by side



Combined motions

On looking through and handling of this catalog,  
you will find the following terms and formula:

Short cut	Description	[ ° ]
$\alpha$	= The rotation angle of the rotating machine element	[ ° ]
$\Delta M$	= Deviation of the center point	[mm]
$a$	= Acceleration	[m/s <sup>2</sup> ]
$AR$	= Outer radius, E-Chain®	[mm]
$Ba$	= Outer E-Chain® width	[mm]
$Bi$	= Inner E-Chain® width	[mm]
$B_{Ra}$	= Guide trough outer width	[mm]
$B_{Ri}$	= Guide trough inner width	[mm]
$D$	= Over length E-Chain® radius in final position	[mm]
$D_2$	= Over length for long travels gliding	[mm]
$FL_B$	= Unsupported length with sag	[m]
$FL_G$	= Unsupported straight length	[m]
$FL_U$	= Unsupported lower run	[m]
$FZ_{max}$	= Maximum additional load	[kg/m]
$H$	= Nominal clearance height	[mm]
$H_2$	= Installation height with lowered mounting	[mm]
$ha$	= Outer E-Chain® height	[mm]
$H_F$	= Required clearance height	[mm]
$hi$	= Inner E-Chain® height	[mm]
$H_{Ra}$	= Outer trough height	[mm]
$H_{Ri}$	= Inner trough height	[mm]
$IR$	= Inner radius, E-Chain®	[mm]
$K$	= Add-on for bending radius (K is taken from the data tables of the individual igus® Series)	[mm]
$K_2$	= Further add-on if the mounting bracket location is set lower (for long travels)	[mm]
$L_K$	= E-Chain® length	[mm]
$n$	= Number of links	[1]
$n_{Mon}$	= Number of installation sets (left/right)	[1]
$n_{Ri}$	= Number of trough-sets (left/right)	[1]
$R$	= Bending radius	[mm]
$RBR$	= "Reverse bending radius"	[mm]
$S$	= Length of travel	[mm]
$S/2$	= Half length of travel	[mm]
$T$	= Pitch	[mm]
$v$	= Speed (travel)	[m/s]
$X_1$	= Inner machine-construction space (TwisterChain®)	[mm]
$X_2$	= Outer radius chain, including clearance (TwisterChain®)	[mm]

Formula	Description
$SFL_B = 2 \cdot FL_B$	= Calculation of maximum travel length, unsupported with sag
$SFL_G = 2 \cdot FL_G$	= Calculation of maximum travel length, unsupported straight
$B_{Ri} \geq Ba + 5$	= Calculation of the minimum guide trough width
$H_{Ri} \geq 2 \cdot ha$	= Calculation of the minimum guide trough height
$K = \pi \cdot R$	= Add-on for bending radius
$L_K = S/2 + \Delta M + K$	= Calculation of chain lengths - for all types of applications, fixed end is outside the center of travel
$L_K = S/2 + K$	= Calculation of chain lengths For all types of applications, fixed end in the center of travel, except rotary movements and most long travels
$L_K = S/2 + K_2$	= Calculation of chain lengths for long travels, fixed end in the center of travel

igus® E-ChainSystems®

Phone +49- (0) 22 03-96 49-800  
Fax +49- (0) 22 03-96 49-222

igus® GmbH  
51147 Cologne

Internet: www.igus.de  
E-mail: info@igus.de

**Calculation of E-Chain® lengths**

If the fixed end of the E-Chain® is located in the center of the travel, the E-Chain® length " $L_K$ " is calculated by using half the length of travel and adding the value "K" for the curved length. (You can obtain the value "K" from the tables in the catalog.) Placing the **Fixed End** in the center of the travel is the most **cost-effective solution** because it requires the shortest E-Chain®, cables and hoses.



**The fixed end in the center of the travel is the most favorable solution**

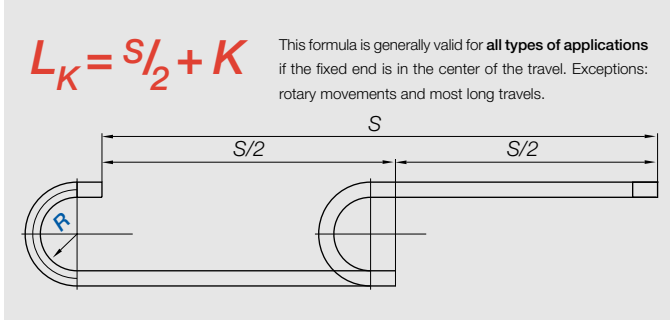

- $L_K$  = E-Chain® length
- $S$  = Length of travel
- $R$  = Bending radius
- $\Delta M$  = Deviation from the center point
- $K = \pi \cdot R + \text{"safety"}$
- Add-on for bending radius (K is taken from the data tables of the individual igus® Series
- $H$  = Nominal clearance height
- $H_F$  = Required clearance height

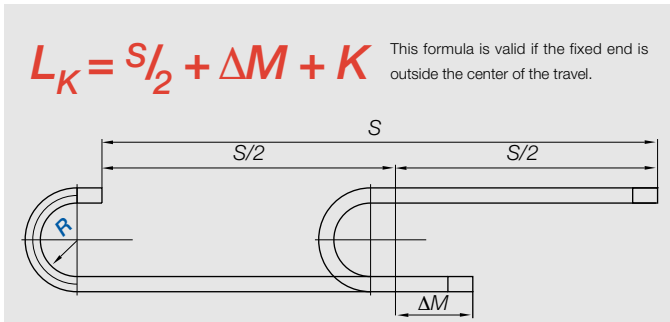

**Camber**

**Camber** is the curve of the upper run along its unsupported length. **All igus® E-Chains® are manufactured with camber, special "no camber" E-Chains® on request.** The camber allows for longer unsupported lengths and increases service life and operating safety. In the Installation Dimensions section of each respective E-Chain® description, you will find the measurement  $H_F$ , which specifies the **necessary clearance height**, taking the camber into account. Upon request, we can deliver E-Chains® without camber for restricted space applications - however, these "no camber" chains do not have the same load-bearing capacity. Please consult igus®.

"No Camber" - Special "NC" E-Chains® with no camber also available. Please consult igus®.

**Necessary clearance height** - depends on the camber of the E-Chain®. Find values for the necessary clearance height " $H_F$ " on each product page.

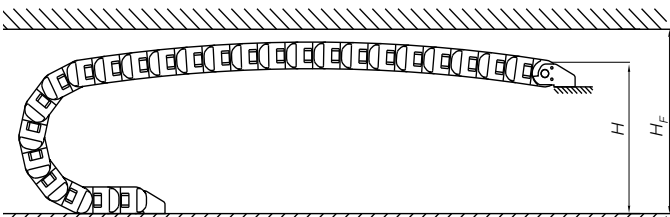

Principle of camber for igus® E-Chains®  $H_F$  = required installation height



Diagrams unsupported length ► page 1.12

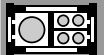
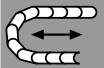



Long travels (441 m) with RoI E-Chain®.  
Long travel applications ► page 1.16



High fill weights (60 kg/m) with System E4.  
Fill weights/Load diagrams ► page 1.12



Multi-axis Easy Triflex® on a production line,  
combined movements ► chapter 2

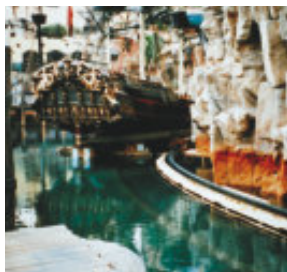

ReadyChain® under water. System E4 and  
Chainflex® CF9, ReadyChain® ► page 1.41



ReadyChain® with combined motions  
on tooling machines ► page 1.41



Series E6.52 high speed (15 m/s) low noise  
operation, optimized noise level ► page 1.11



Crash test unit: 22 m/s speed and  
784 m/s² acceleration, travel speed



Complex movements with Triflex® R,  
combined movements ► chapter 2



Cleanroom and Triflex® R  
Technical Environment ► chapter 2



Extension links for E2 and E4 for large  
conduits, cable and hoses ► page 1.28



Zig-Zag movements, 36 m height with  
E4/4. Zig-Zag movements ► page 1.21



igus® System E6 - High acceleration and  
ESD safety, ESD & ATEX ► page 1.35



Unsupported application System E4,  
up to 50 m/s speed ▶ page 1.8

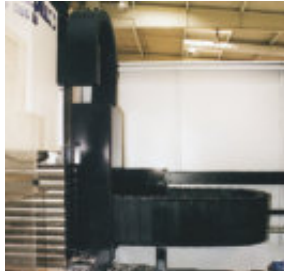

Unsupported, side-mounted  
E4 Series R188 ▶ page 1.24



Unsupported application  
System E4 ▶ chapter 7



Gliding application System E4,  
up to 500 m realized ▶ page 1.16



Gliding, side-mounted  
Series E4/4 ▶ page 1.24



Gliding application  
System E4 ▶ page 1.23

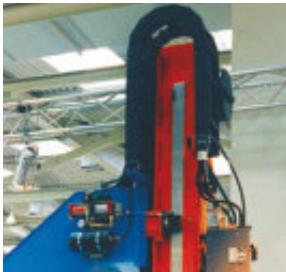

Vertical, standing Series E4/light,  
up to 6 m possible ▶ page 1.22



Rotary movement  
System E4 ▶ page 1.26



E-Chains® side by side as individual or  
"multiband" - Series Zipper ▶ chapter 4



Vertical, hanging Series E4 up  
to 40 m possible ▶ page 1.20

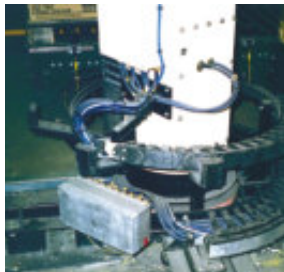

Spiral and rotary movement  
TwisterChain® ▶ page 1.26

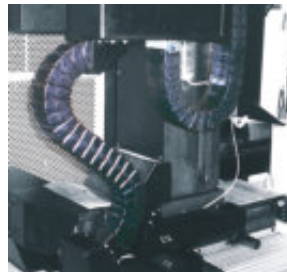

Combined movement  
Series Triflex® ▶ chapter 2

Design  
Solutions

Phone +49- (0) 22 03-96 49-800  
Fax +49- (0) 22 03-96 49-222

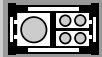
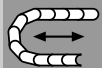





**Unsupported**

If the upper run of the E-Chain® operates without touching the lower run over the entire travel, it is called an "unsupported" application.

**Unsupported length**

The distance between moving end and the beginning of the radius curve of the E-Chain® is called the "unsupported length." It is always dependent upon the type of E-Chain® and the fill weight.



The " $FL_G$ " type of installation always generates the longest service life and can be operated with the max. values for speed and acceleration.



Example for unsupported straight  $FL_G$

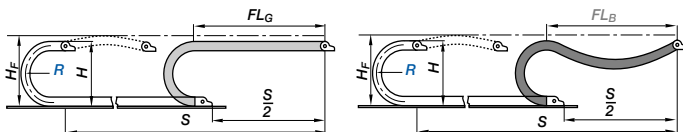

**Unsupported applications**

The "unsupported" application is the most common. igus® E-Chains® are very well suited for high dynamics and long service life. The maximum unsupported length is dependent upon the fill weight and the type of E-Chain® or E-Tube. As a result, we differentiate among three types of unsupported length:

**01) Unsupported with straight upper run  $FL_G$**

The " $FL_G$ " E-Chain® applies when the upper run either has camber, is straight, or has a maximum of 10-50 mm sag, depending on the size of the chain. The " $FL_G$ " type of installation is always preferred. The E-Chain® runs quietly and is not exposed to any additional vibration.

**02) Unsupported with permitted sag  $FL_B$**

The " $FL_B$ " E-Chain® applies when the sag amounts to more than 10-50 mm, depending on the chain size, and less than a defined maximum sag. This maximum sag is dependent on the type of chain. The " $FL_B$ " application is technically permissible in many cases. It becomes problematic if the acceleration and the travel frequency are high.

**03) "Critical sag"**

If the sag is greater than permissible for " $FL_B$ ", then we refer to it as "critical sag." An installation with critical sag must be avoided or reserved for extreme circumstances. An E-Chain® should never be installed with critical sag. There are applications which, after a very long period of use, reach the stage of "critical sag." The E-Chain® or E-Tube should be replaced at that time.

Please contact us if your application reaches critical sag!

The following important factors should be considered to select the correct E-Chain®:

- Unsupported length
- Speed
- Acceleration
- Service life
- Load bearing areas
- Noise level
- Technical environment

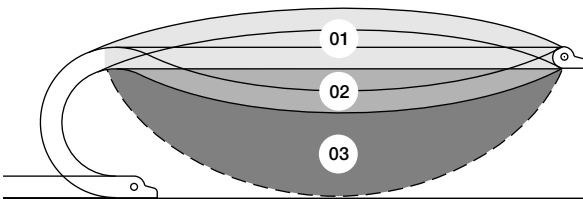



Example of unsupported permissible,  $FL_B$



**Unsupported Length**

For every igus® E-Chain® or E-Tube, you will find the values for " $FL_G$ " and " $FL_B$ " in two locations: On the following pages in this chapter as an overview and within every individual series' chapter. These values are essential for: ● Finding a suitable E-Chain® for your fill weight and travel distance ● Identifying the maximum load for the selected E-Chain®.

Diagrams unsupported length ▶ from page 1.12

**What to do if the unsupported length is insufficient**

If your application, fill weight and travel fall outside the "unsupported length" parameters of the desired E-Chain®, you have the following options:

- Select a more stable igus® E-Chain®
- Support the E-Chain® in the unsupported area (this possibility has restrictions for acceleration, speed and noise as a consequence - three fundamental examples are detailed to below - please consult igus® if you are considering this possibility - we will gladly provide you with a detailed proposal)
- Use a "multiband" chain or "nest" two E-Chains® inside one another (please consult igus® regarding these options)
- Design the travel distance as a "gliding application".

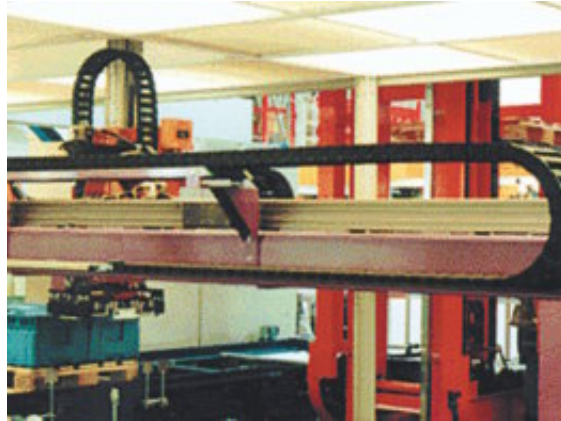

Series 28 with support of the " $FL_B$ " area

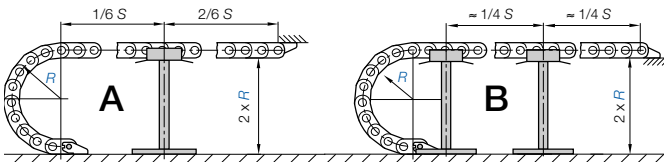

Support of the " $FL_G$ " area. A) The overall "straight, unsupported travel" can be increased here by a maximum of 50% of the  $FL_G$  and in case of option B) by a maximum of 100%

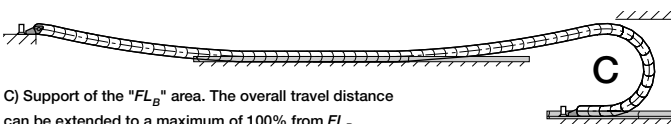

C) Support of the " $FL_B$ " area. The overall travel distance can be extended to a maximum of 100% from  $FL_B$

More application-examples for short travel applications ▶ [www.igus.de](http://www.igus.de)

Design  
Unsupported

Phone +49- (0) 22 03-96 49-800  
Fax +49- (0) 22 03-96 49-222

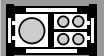





Standard values of max. speed and acceleration:

Unsupported	$FL_G$	$FL_B$
v max. [m/s]	10	3
v peak [m/s]	20	-
a max. [m/s <sup>2</sup> ]	20	6
a peak [m/s <sup>2</sup> ]	784	-

Standard value of  $FL_G$  service life: 10 million cycles

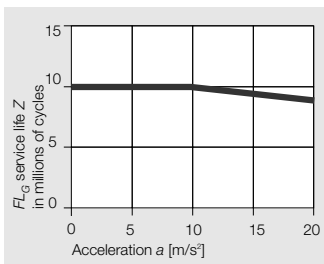

Standard values on service life for  $FL_G$ , (unsupported, straight), dependent on acceleration



Preferred Series for max. speed and acceleration

- System E6 ▶ chapter 8
- System E3 ▶ chapter 8
- Zipper ▶ chapter 4
- Series 255 ▶ chapter 5
- E4/00 ▶ chapter 7

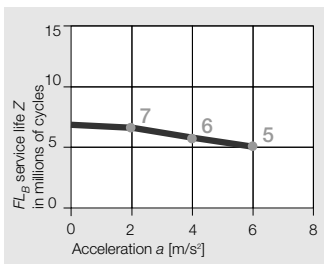

Standard values on service life for  $FL_B$  (unsupported, sag), dependent on acceleration

## Speed, acceleration and service life

For unsupported applications, the acceleration  $a$ , is the critical parameter. High acceleration can cause the E-Chain® to vibrate and reduce its service life. This is a particular danger if the E-Chain® already has a sag greater than the  $FL_G$  value. Max. values for acceleration, speed and service life are achieved only with E-Chains® incorporating the  $FL_G$  design.  $FL_G$  designed E-ChainSystems® can sustain very high loads. To date, a peak acceleration of 784 m/s<sup>2</sup> has been achieved during continuous use. Through ongoing testing in the igus® laboratory and from practical experience, standard values for service life have been formulated. Our tests confirm that these standard values apply to all igus® E-Chains and E-Tubes. It is crucial to determine whether the application will be designed as unsupported straight  $FL_G$  or unsupported, with sag  $FL_B$ .

## Load-bearing surfaces

Unsupported E-Chains® normally require some type of surface on which the lower portion of the E-Chain® runs. A wide range of configurations is available, as the drawings on the right demonstrate. Many material options are feasible: Metals, polymers, stone, wood, concrete, glass, etc. We also have solutions to minimize the noise generated by the chain's lower portion. Please consult igus®. When selecting the running surface, be sure dirt and debris cannot collect in the E-Chain® path.

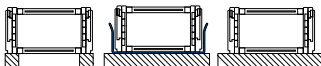

Different surfaces + guide troughs are possible

## Mounting brackets

We recommend pivoting mounting brackets as standard for unsupported applications. Pivoting mounting brackets compensate for the camber, can be installed more easily and decrease the load on the first E-Chain® link in operation. **Exception:** If the acceleration is greater than 20 m/s<sup>2</sup> or if the height is limited to the  $H_F$  measurement, locking mounting brackets keep the E-Chain® under the  $H_F$  measurement.

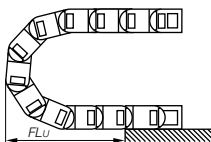

We recommend pivoting mounting brackets as standard! We recommend locking mounting brackets as standard if high speeds > 20 m/s or accelerations > 20 m/s<sup>2</sup>

## Unsupported lower run

E-Chains® without support along the lower run have restricted use. The value  $FL_U$  usually must be determined in a test by igus®. The maximum permissible amount of the projection depends on the fill weight, the selected E-Chain®, the dynamics, and other factors, because the various combinations of these parameters can produce very different results. **If the lower run of the E-Chain® cannot be supported over the whole travel, please consult igus®.**



System E4 partially unsupported - please consult igus® regarding this type of configuration

**Minimize noise levels with igus® E-ChainSystems®**

The igus® program offers you optimal noise-reduction E-Chains®. The table below briefly illustrates the differences in noise level among various E-Chains®. In addition to the E-Chain®, the running surface, the dynamics and the cable and hose package play a role in overall noise generation. Have our specialists design the quietest E-ChainSystem® for your application, for example:



A reduction of 3 dB(A) sounds like a 50% reduction in the noise level to the human ear



**System E3 - low-noise, 38 dB(A)**

Long-term tests in the igus® acoustic laboratory showed reductions of 19-20 dB(A) compared with standard E-Chains®, measured at a speed of 1.8 m/s and an acceleration of 3 m/s². Figure determined in the igus® laboratory in accordance with DIN 45635, taking into consideration background noises, for the **Series E3.22.060.044.0**.



**System T3 ≤ 33 dB(A)**

Optimal smoothness of motion was the prime development goal, as well as making it an economic solution. The igus® T3 profile chain is very flexible and runs -due to the special geometry- very smooth. A measurement indicates a value of ≤ 33 dB(A) at 1 m/s and with an unsupported length with Series T3.29.050.038.0, and all this with a sound pressure level generated by external noise.



**System E6 ≤ 46 dB(A)**

A measurement conducted by the Rhineland Technical Inspection Authority (TÜV Rheinland) in May 2002 indicates a value of ≤ 46 dB(A) at 2 m/s and with an unsupported length of 1.5 m with **Series E6.52.10.100.0**, and all this with at least 10 dB(A) sound pressure level generated by external noise. The System E6 runs due to their small pitch very smooth. (rest weg lassen, kann ich nicht übersetzen)



**System E4 ≤ 46 dB(A)**

A measurement by the Rhineland Technical Inspection Authority (TÜV Rheinland) for **System E4/101, Series 221.10.200.0** indicates a value of 46 dB(A) at 1,5 m/s with an unsupported length. Due to the special rubber pads (in red pictured) of the System E4/101, the noise will be extremely damped. The standard version of E4/00 is already very noise reduced due to their special designed stop dog.



We have received an official comment from the Rhineland Technical Inspection Authority (TÜV Rheinland Berlin-Brandenburg) and we are able to provide you with a copy on request

**Selected noise tests - external noise corrected measurement values**

E-Chain® Series	System	Averaging of the corrected sound pressure levels	Test method
igus® Series T3.29	T3	≈ 33 dB(A)	unsupported 1,0 m/s
igus® Series E3.22	E3	≈ 38 dB(A)	unsupported 1,8 m/s
igus® Series E6.52	E6	≈ 46 dB(A)	unsupported 2,0 m/s
igus® Series 221	E4/101	≈ 46 dB(A)	unsupported 1,5 m/s
igus® Series 255	E2 medium	≈ 53 dB(A)	unsupported 1,5 m/s
igus® Series E-Band	E-Band	≈ 59 dB(A)	unsupported 1,5 m/s
igus® Series 280	E4/00	≈ 64 dB(A)	unsupported 2,0 m/s
igus® Series 381	E4/101	≈ 66 dB(A)	gliding 3,0 m/s
Chain 1 Third Party Product		≈ 77 dB(A)	unsupported 2,0 m/s
Chain 2 Third Party Product		≈ 68 dB(A)	unsupported 2,0 m/s
Chain 3 Third Party Product		≈ 73 dB(A)	unsupported 2,0 m/s

Source: TÜV Rheinland, except Series E3.22 - Source: igus® laboratory



Preferred igus® E-Chains® for minimizing noise

- System E3 ▶ chapter 8
- System T3 ▶ chapter 8
- System E6 ▶ chapter 8
- E4/101 ▶ chapter 7
- E4/00 ▶ chapter 7
- Series 255 ▶ chapter 5
- Easy Chain® ▶ chapter 3
- Series R58 ▶ chapter 6
- Series R68 ▶ chapter 6

Design Unsupported

Phone +49- (0) 22 03-96 49-800  
Fax +49- (0) 22 03-96 49-222



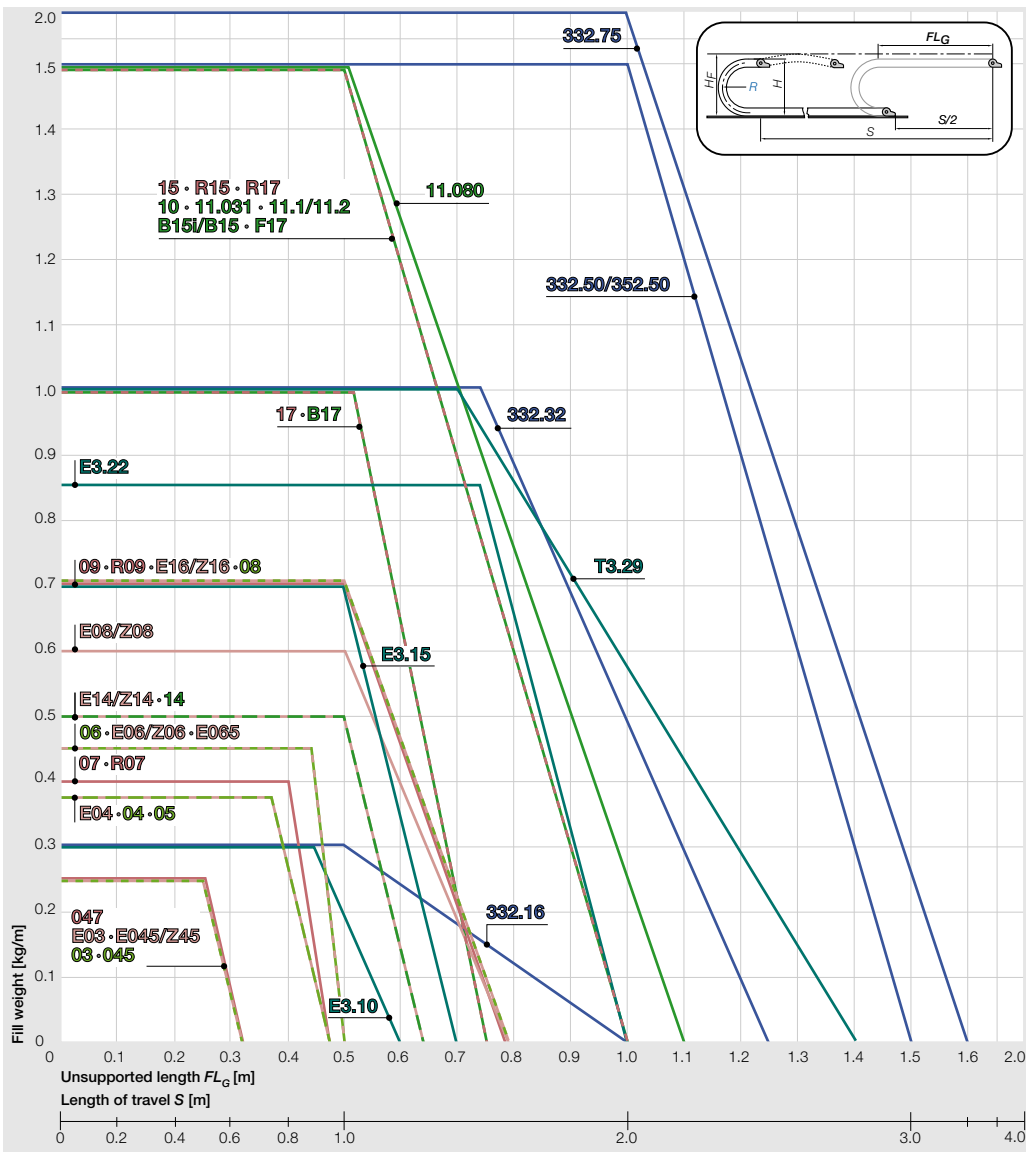

### Important information

- Fill weight - Weight of all cables and hoses, including contents (for media hoses) within the E-Chain®, typically given [kg/m]
- $FL_G$  - unsupported E-Chain® with straight upper run
- $FL_B$  - unsupported E-Chain® with permitted sag
- To the right of the  $FL_G$  graph of the diagram, the application is shown in "critical sag", which must be avoided!

These values are essential for: ● Finding a suitable E-Chain® for your fill weight and travel distance ● Identifying the max. load for the selected E-Chain®. If you cannot meet your application demands using these parameters, keep in mind these specifications are conservative maximum values. In individual cases, they can be exceeded by up to 30%. Special solutions are also possible. Please consult igus®

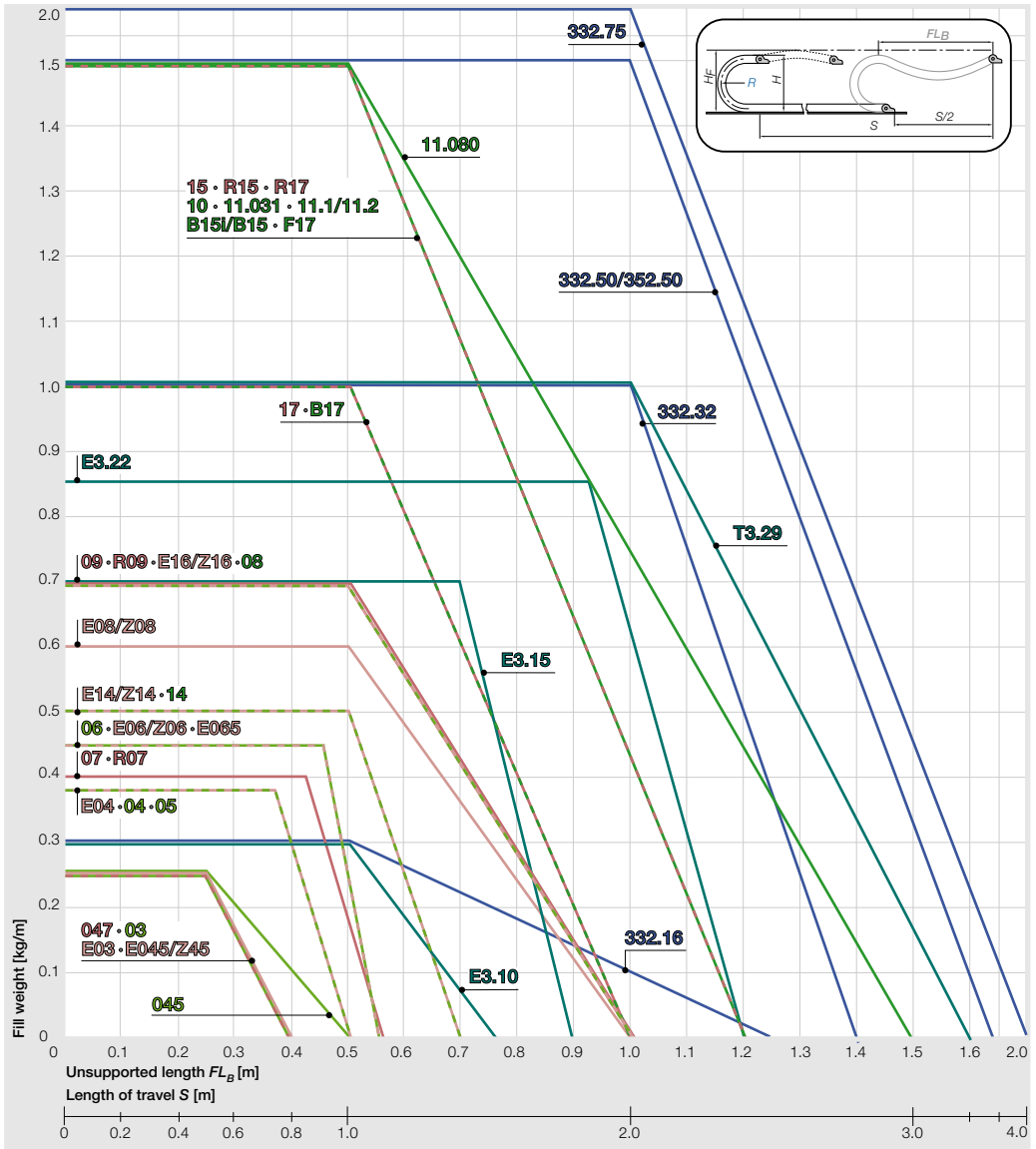

The maximum travel -always amounts to  $2 \times 2 \times FL_G$  or  $FL_B$  if the fixed end is in the center of the travel. In this case, the following applies:

$$E\text{-Chain}^\circ \text{ length: } L_k = \frac{S}{2} + K$$

$S$  = Length of travel

$R$  = Bending radius

$H$  = Nominal clearance height

$H_f$  = Required clearance height

$K = \pi \cdot R + \text{"safety"}$  Add-on for bending radius

( $K$  is taken from the data tables of the individual igus® series)

#### Diagram Series:

- Triflex® ▶ chapter 2
- Easy Chain® ▶ chapter 3
- System E3 ▶ chapter 8
- System T3 ▶ chapter 8
- Zipper ▶ chapter 4
- E2 micro ▶ chapter 5
- E2 mini ▶ chapter 5

You will find both diagrams for each series listed individually in the catalog!

Find the values for " $FL_G$ " and " $FL_B$ " also ▶ in every individual Series chapter!

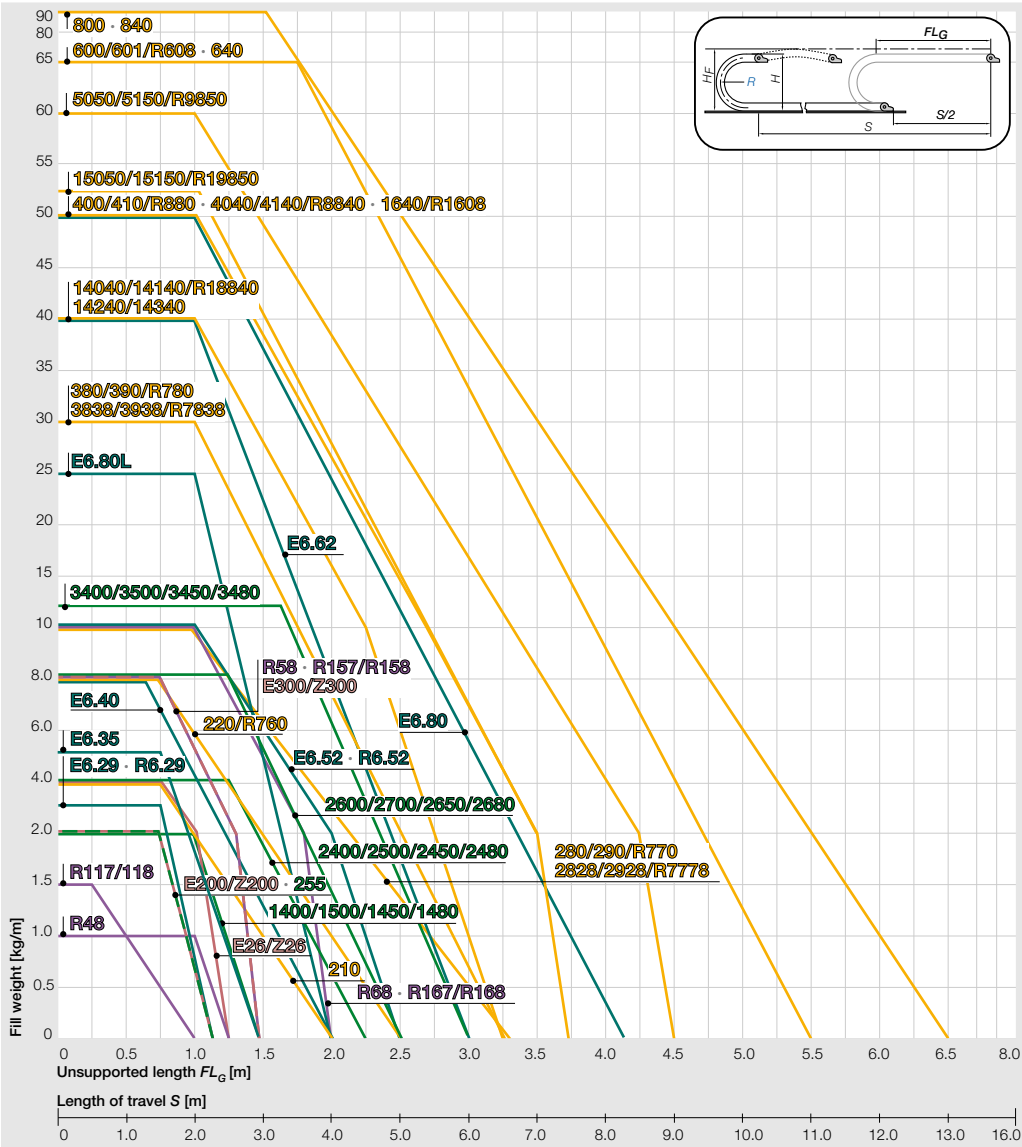

### Important information

- Fill weight - Weight of all cables and hoses, including contents (for media hoses) within the E-Chain®, typically given [kg/m]
- $FL_G$  - unsupported E-Chain® with straight upper run
- $FL_B$  - unsupported E-Chain® with permitted sag
- To the right of the  $FL_B$  graph of the diagram, the application is shown in "critical sag", which must be avoided!

These values are essential for: ● Finding a suitable E-Chain® for your fill weight and travel distance ● Identifying the max. load for the selected E-Chain®. If you cannot meet your application demands using these parameters, keep in mind these specifications are conservative maximum values. In individual cases, they can be exceeded by up to 30%. Special solutions are also possible. Please consult igus®

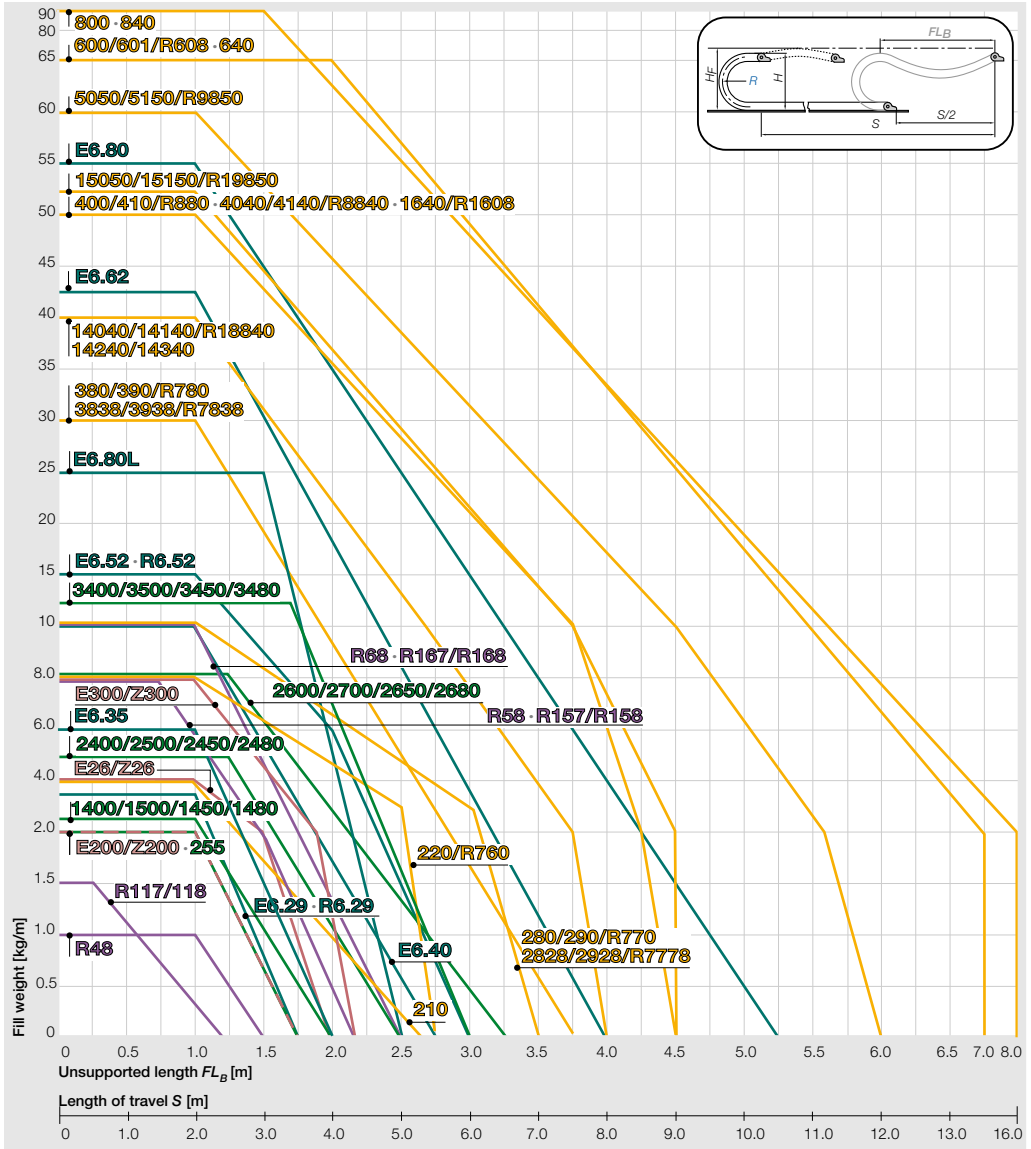

The maximum travel -always amounts to  $2 \times 2 \times FL_G$  or  $FL_B$  if the fixed end is in the center of the travel. In this case, the following applies:

$$E\text{-Chain}^\circ \text{ length: } L_k = \frac{S}{2} + K$$

$S$  = Length of travel

$R$  = Bending radius

$H$  = Nominal clearance height

$H_f$  = Required clearance height

$K = \pi \cdot R + \text{"safety"}$  Add-on for bending radius

( $K$  is taken from the data tables of the individual igus® series)

### Diagram Series:

- Easy Chain® ▶ chapter 3
- E2/000 ▶ chapter 5
- E2 E-Tubes ▶ chapter 6
- E4/00 ▶ chapter 7
- E4/4 ▶ chapter 7
- E4/light ▶ chapter 7
- E6 ▶ chapter 8

You will find both diagrams for each series listed individually in the catalog!

Find the values for " $FL_G$ " and " $FL_B$ " also ▶ in every individual Series chapter!





**Gliding application -**

If the upper run of the E-Chain® rests on the lower run, it is a gliding application



- Over 400 m travel
- 5 m/s speed
- Fill weights up to 70 kg/m



Conveyor belt in quarry. Application with travel distance of 179 m, travel speed 67 m/min., fill weight 8 kg/m

**Advantages for long travel applications with igus® E-Chains®**

- Travels over 400 m
  - Gliding speeds up to 5 m/s (more in individual cases)
  - Service life of 10 years and more with igus® E-ChainSystems®
- Further advantages of the design are:**
- Many different types of cables and hoses can operate side by side in the same system (i.e. electrical, data, fiber optic cables with hydraulic and pneumatic hoses)
  - Space-saving installation
  - Quiet operation
  - High accelerations
  - Durable in wind, weather, dirt, and chemicals
  - Simple assembly of the modular system on the spot
  - Rapid assembly and replacement of cables and hoses

**Design assistance, free of charge**

We recommend that igus® calculate every gliding application for you. We will always offer the most cost-effective solution, taking the technical requirements and operating safety into consideration. The system solution designed by us is also automatically given an igus® system guarantee. **To be able to advise you accurately, we require the following specifications:**

- Travel [m]
- Travel speed [m/min] or [m/s]
- Acceleration [m/s²]
- Fill weight [kg/m]
- Maximum cable/hose outer diameter [mm]
- Type and number of cables and hoses
- Required bending radius [mm]
- Cycle frequency (n/day or n/hour)
- Technical environment.

**Please call us and within hours you will receive a detailed system proposal!**

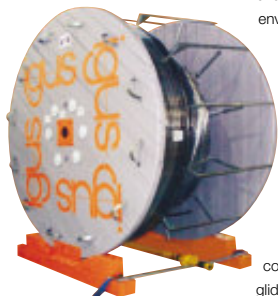

**Trends in long travel applications**

**Very long travels with igus® Rol E-Chain. - Rolling instead of gliding:** 75% less push-/pull forces due to special roller-links. Travels up to 800 m are possible. At the present longest travel length, Project: Ship to Shore Crane, Malaysia. 441,3 m with Rol E-Chain® 5050R ► [igus.de/en/rolechain](http://igus.de/en/rolechain)

● **Long travel systems "off the reel" - save already at the state of assembling:** Complete custom-made E-ChainSystems® with cables, connectors, strain relief - are delivered on the reel and "rolled off" into the preassembled Guide Troughs. Time savings of 50 % possible. Please ask us for references

► [igus.de/en/readychain](http://igus.de/en/readychain)

● **Long travels without guide troughs:** Our AUTO-GLIDE system consists of self-guiding E-Chains® for travels up to 50m travel lengths (speed 1,5m/s) due to special gliding elements on the crossbars ► [igus.de/en/autoglide](http://igus.de/en/autoglide)

● **Long travels with very small E-Chains®.** Micro Flizz® offers the guidance of cables inside a small E-Chain® with high acceleration on long travel applications ► [igus.de/en/flizz-n](http://igus.de/en/flizz-n)

Long travel "off the reel." Up to 100 m travel pre-assembled and ready to install



Travel distance of 441,3 m realized with the igus® Rol E-Chain® Series 5050R



**Preferred igus® E-Chains® gliding, long travels**

- Rol E-Chain® ► chapter 9
- System E4 ► chapter 7
- E2/000 ► chapter 5

## Gliding applications principle

For long travels, the upper run of the igus® E-Chains® rests on the lower run. The upper run glides partially on the lower run and partially at the same height on a glide bar. The diagrams below show this. For lateral guidance, a Guide Trough is necessary. If the stationary mounting bracket and the fixed end of the cables and hoses can be placed **in the center**, the chain length is calculated as follows:  $L_k = S/2 + K$ . Depending on the technical data and the selected E-Chain®, the mounting point of the moving end of the E-Chain® must be lowered on some units ► **Lowered mounting height**. In our system analysis for long travels, we give exact details for your specific application.



Example of lowered mounting height



### Advantages lowered moving end:

- Space saving
- Longer travels possible
- Higher service life due to less wear

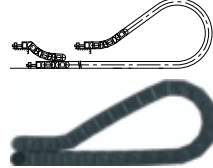

Example: Series 3838

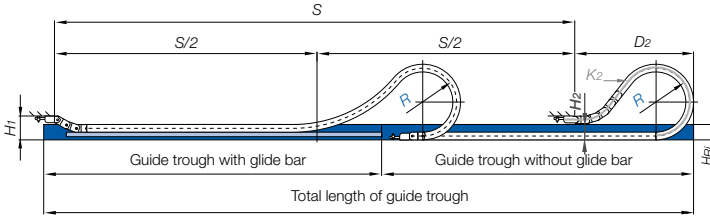

The function of an E-ChainSystem® for gliding applications (schematically)

The fixed end of the E-Chain® is located in the center of the travel distance

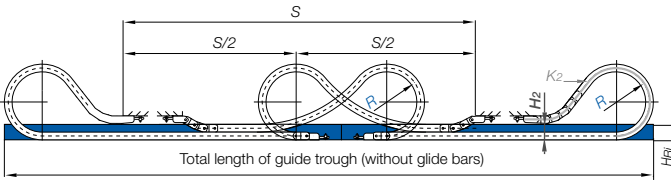

For a configuration involving two opposed E-Chains®, the travel is measured as shown and selected when these factors apply: ● Restricted space ● High loads

### E-Chain® length:

$$L_k = S/2 + K$$

S = Length of travel

R = Bending radius

H<sub>ri</sub> = Trough inner height

H<sub>F</sub> = Required clearance height

K<sub>2</sub> = Further add-on if the mounting bracket location is set lower (specified by igus®)

K = π · R + "safety" Add-on for bending radius (K is taken from the data tables of the individual igus® Series)

D<sub>2</sub> = Over length for long travels gliding

H<sub>2</sub> = Installation height with lowered mounting

● Guide trough

● Glide bar



Mobile camera, Olympic Games in Atlanta, S = 100 m, v = 10 m/s in push-pull operation



Robotics: quiet running, high acceleration, up to 10.000 cycles per day, System E4/4



Gliding applications = Pivoting mounting brackets

Design Gliding - Long Travel

Phone +49- (0) 22 03-96 49-800  
Fax +49- (0) 22 03-96 49-222

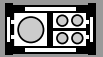
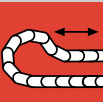



Guide troughs are used for long travels. They allow igus® E-Chain® and E-Tubes to continue smooth, low-friction operation in these long-travel situations. Various guide trough-systems are available ► Guide Troughs, chapter 9



If the fixed point is in the center of the travel, use half of the guide trough with glide bars ... and the other half of the guide trough without glide bars

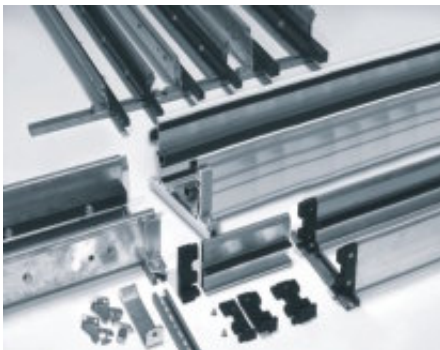

### Guide troughs

The guide trough is an important element in long travel applications. Usually, the height of the trough must be at least twice that of the E-Chain® link height. The sides must provide a chamfered opening. The trough inner width is the same as the E-Chain® outer width, plus 5 mm ( $B_{Ri} = Ba + 4$ ). Along the side of the trough, where the upper run cannot glide on the lower run, glide bars must be installed. We recommend the

use of polymer glide bars from igus®. They are optimally matched to the E-Chain® material and achieve the lowest values for friction, noise and wear. Guide troughs with and without glide bars can be obtained for almost all igus® E-Chains®. **Important: When assembling the trough parts, the following points must be given particular attention:** ● Properly align all trough parts upon installation ● All screw heads should be flush with the trough ● Smooth levelled transition between the end of the E-Chain® and the glide bars ● Solid connection with the glide surface. **These points must be observed when using assembly-friendly igus® guide troughs.**

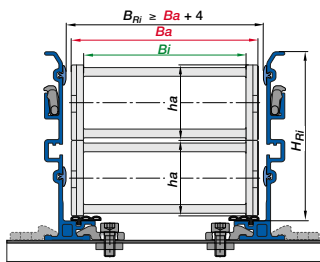

Demonstration: Guide troughs without glide bars - upper run glides on the lower run.

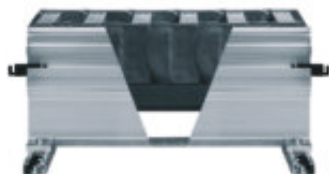
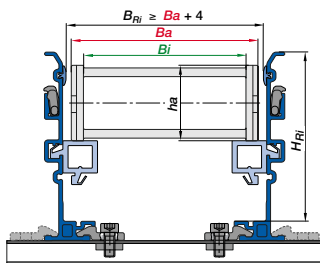

Demonstration: Guide troughs with glide bars. We recommend the use of polymer glide bars from igus® made of igulen. They are optimally matched to the E-Chain® material and achieve the lowest values for friction, noise and wear.

- $Ba$  = E-Chain® outer width
- $Bi$  = E-Chain® inner width
- $ha$  = E-Chain® outer height
- $H_{Ri}$  = Inner trough height
- $B_{Ri}$  = Inner trough width ► depending on  $Ba$

!  $H_{Ri} \geq 2 \cdot ha$   
■  $B_{Ri} \geq Ba + 4$

- = Guide trough-set
- = Glide bar
- = Installation set\*Basic"
- = C-Profile

### Glide friction values for igus® E-Chains® made of igumid G and various glide bars

igumid G special	igus® polymer bar igulen	Glide sheet steel	Anodized aluminum	Stainless steel
Friction value	0,19	0,45	0,54	0,48
dynamic				

Source: igus® laboratory

## Travel speeds and accelerations

Travel speeds up to 5 m/s in continuous operation are possible and in use on current applications. In special cases, even higher speeds are possible. For example, E4/00 and E4/4 E-Chains® achieve **speeds of 22 m/s and accelerations of 784 m/s<sup>2</sup>** in crash test units. (Only a few thousand cycles per year are required in this situation.) Acceleration plays a large role in the calculation. Differentiations must be made between normal operational acceleration and a sudden jolt of acceleration such as unexpected stops or so-called "E-stops." Even in these situations, igus® E-Chains® prove to be very durable.

## Service life

We offer service life calculations for your application based on our extensive gliding application experience. As developers of polymer plain bearings, we possess vast material behavior knowledge which we apply to the development of E-Chains® as well. Units with 200 m travels have been in operation for 8 years with



Automated storage/retrieval system with System E2 and Chainflex® cables - travels up to 80 m and speed of 4.5 m/s

## Technical environment

Long travel applications using igus® E-Chains® run in water, in dirt, in the tropics, in explosion risk areas (with special design features) and many other conditions. Guide troughs can be supplied in corrosion-free materials. You will find more details in the Technical Environment section of this chapter.

## Calculation

Comprehensive tests place us in the position of knowing our products precisely. Important factors in these tests are: ● Push-pull forces under both ambient and extreme temperatures ● Humidity and dirt ● Friction values of the polymers, alone and against various glide surfaces ● Behavior of electrical conduits under push-pull conditions ● Behavior of hydraulic and media hoses under push-pull conditions ● Service life, and noise generation. **If we cannot in fact calculate your application based on these factors, we will perform a practical test for you in our laboratory. Please consult igus®.**



E4 in a pre-cast concrete plant with dust and concrete sediment



**Corrosion-free guide troughs are available in the material:**

- Normally galvanized
- Stainless steel
- Seawater resistant aluminum

## Special properties - Long travel applications

E-Chains® that are **nested** can be used in gliding applications. This type of installation is most often used when there is a width restriction. Guide troughs with special wall heights are necessary. E-Chains® **running side by side**, or in a "multiband" design can also be used in gliding applications. Higher fill weights often require special guide troughs which can be delivered either from stock or on short notice. We have also developed standard parts for unconventional solutions involving **large hoses** in gliding applications.



Nested, gliding E-Chains®



"Multiband" E-Chain®

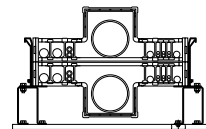

Large hose elements

## Technical data - long travels

Travel max	400 m (800 m)
Travel speed max	5 m/s
Travel acceleration max	dependent on calculation, can be 50 m/s <sup>2</sup> and more
Fill weight maximum	dependent on calculation, can be 70 kg/m and more

More application-examples for long travel applications ► [www.igus.de](http://www.igus.de)

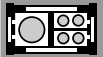
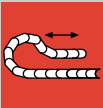



We recommend locking mounting brackets for hanging applications. In restricted spaces, other solutions are possible with consultation

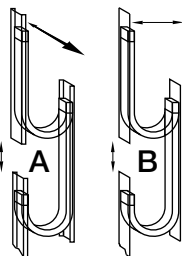
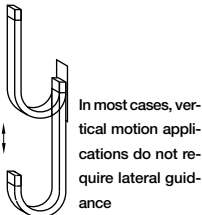

Lateral acceleration can occur in two directions - guidance is necessary

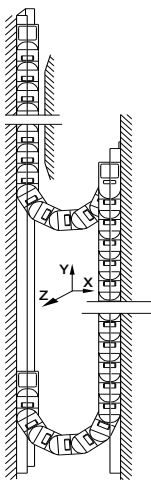

Principle of a hanging E-Chain® with lateral guidance - lateral accelerations in both directions are intercepted



### Vertical, hanging applications

In accordance with the principle of "hanging" applications, heights of over 100 m are possible with igus® E-Chains®. Chains with interior separation allow many different types of conduits to operate together in the same system without becoming entangled.

### Cables and hoses

Two important factors in vertical hanging applications are how the conduits lay in the E-Chain® and how they are secured at the end points: All cables and hoses must be hung so that they bear their own weight. The E-Chain® fulfills the function of orderly conduit bundling only and should not absorb any further tensile forces. **igus® interior separation**

**elements should be used for distinct division of all cables and hoses. The cables and hoses must be secured carefully to both end points of the E-Chain®.** The strain relief must be designed so that the opposite run cannot catch. **Safe strain relief and clear separation of the conduits are the basic prerequisites for hanging installations - Cables must be able to move freely and bear their own weight**

### Camber

A normal igus® E-Chain® with camber is suitable for hanging use if enough space is available. If there is no room - as is frequently the case for storage and retrieval systems in narrow aisles - a "no camber" E-Chain® must be ordered. **Order example: 2700.07.100.0.NC (NC = no camber).** These versions are offered at no additional charge (Exception: System E2 E-Chains® + 6%), but with a slightly longer delivery period - usually 1-2 business days longer.

### Vertical motion without lateral acceleration

If the application involves vertical motion without lateral acceleration, the E-Chain® can be installed without lateral support. If the space restrictions are severe, an igus® E-Chain® with no camber must be specified.

### Vertical motion with lateral acceleration

If lateral acceleration occurs, lateral guidance of the E-Chain® must be provided in most cases. The diagram to the right shows the principle of such guidance. Partial guidance is also an option - however, it must at least cover the area in which the E-Chain® may sway. Lateral acceleration can occur in two directions. The lateral guidance must be installed accordingly. If you have a choice, the layout in **Figure A** is preferred. Additional guidance along the side of the E-Chain® helps to stabilize the chain further.

### New for the E2-System: Guidelok - no swinging sideways of the E-Chain®

**The problem:** Suspended E-Chains® swing out due to transverse acceleration - **The solution:** New "Guidelok" system. E-Chain® stays on track even with acute transverse acceleration! When the chain moves over the control button ① the fixing button ② is moved, the lower run of the E-Chain® held in place, preventing it swinging out. For elevators, racking units, material handling equipment. igus® For vertical applications with lateral motion, igus® Guidelok offers a simple, cost-effective and safe system solution. Please call us if you're interested in this product! **Typical applications** ● Automated storage/retrieval systems ● Lifts ● Revolving storage systems ● Diagonal lifts ● All vertical applications

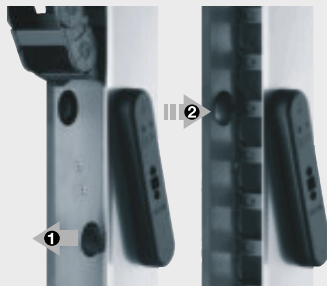

Video ► [www.igus.de/guidelok](http://www.igus.de/guidelok)

igus® E-ChainSystems®

Phone +49- (0) 22 03-96 49-800  
Fax +49- (0) 22 03-96 49-222

igus® GmbH  
51147 Cologne

Internet: [www.igus.de](http://www.igus.de)  
E-mail: [info@igus.de](mailto:info@igus.de)



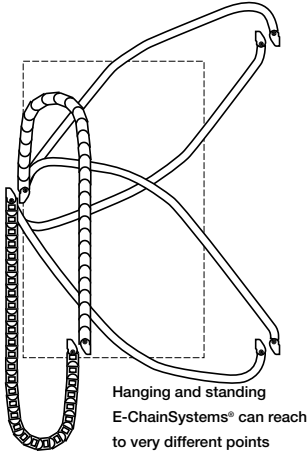

Hanging assembly with one-sided U profile

### Technical data - vertical hanging

Travel height max:	100 m
v max:	20 m/s dependent on height and stability of the E-Chain®
a max:	50 m/s <sup>2</sup> dependent on height and stability of the E-Chain®

### "Zig-Zag" design

The modular design of igus® E-Chains® facilitates this space-saving and unconventional solution. For modern platform technology, such as performance stages, a variety of conduits which adjust the stage height must be accommodated. Lack of space almost invariably presents particular difficulties. The photo below shows an E-Chain® in a "Zig-Zag" configuration produced by incorporating reverse bend radii or "RBR". The unextended E-Chain® is stored in a "basket" underneath the stage. If the stage is raised, the E-Chain® unfolds, generating little to no noise. This construction is possible with System E4/4 E- Chains® as well as many other types. Please consult igus® for these kinds of applications.



With the E-Chains® of the Systems E4 - "Zig-Zag" solutions can be realised quickly and cost-effectively without special parts



#### System design

Due to the wide variety of combinations involving stroke height, cable/hose packages, dynamic values, and application environments, we strongly recommend you make use of our consulting services. Simply call, E-mail or fax us.



#### Preferred Series for vertical, hanging design

- E4/00 ▶ chapter 7
- E4/4 ▶ chapter 7
- E2/000 ▶ chapter 5
- E2 E-Tubes ▶ chapter 6



#### Preferred Series for "Zig-Zag" design

- E4/4 ▶ chapter 7

Design Vertical - Hanging

Phone +49- (0) 22 03-96 49-800  
 Fax +49- (0) 22 03-96 49-222

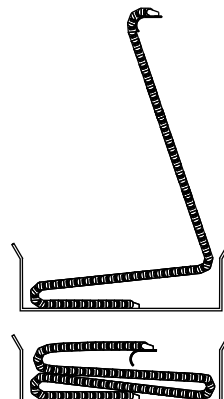
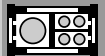
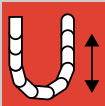

Space-saving solution - stroke heights of over 20 m are possible





We recommend locking mounting brackets for standing applications



Standing application with support of the first E-Chain® links - R68 E-Tube



Cables must be able to move freely and bear their own weight



Locking KMA mounting brackets  
Series 4040 E4/4

### Mounting brackets

The mounting brackets must be attached so that the E-Chain® cannot bow out. The igus® program offers locking or one-sided, locking mounting brackets for almost all types of E-Chains®. Locking KMA mounting brackets are highly recommended because they can be attached flush to the machine.

### Cables and hoses

Cables and hoses must be laid in the E-Chain® so that they can bend freely. For precise guidance of the cables and hoses, we strongly recommend igus® interior spacer modules. Cables must be strain relieved at both ends.



Preferred Series for vertical, standing applications

- E4/00 ► chapter 7
- E4/4 ► chapter 7
- E2/000 ► chapter 5
- E2 E-Tubes ► chapter 6

### Technical data - vertical - standing applications

Max. stroke height - without support	≈ 4 m
Max. stroke height - with support of the first E-Chain® links	≈ 6 m
Max. stroke height - with full support	≈ 20 m
v max (dependent upon stroke height and weight)	20 m/s
a max (dependent upon stroke height and weight)	50 m/s <sup>2</sup>



U-shaped supported E-Tube for high lateral acceleration

### Lateral acceleration

If lateral acceleration occurs, the E-Chain® should be supported along the outer radius. For higher E-Chain® heights, it is generally recommended that at least the first three links on the outer radius be supported. For maximum heights and weights, the whole distance must often be supported. **Due to the wide variety of combinations involving weights, stroke heights, E-Chain® types and bending radii, we strongly recommend you make use of our consulting services.**

### Combined movements

Combined vertical and horizontal movements are possible with igus® E-Chains® for a cost-saving solution.



Combined horizontal and vertical movements

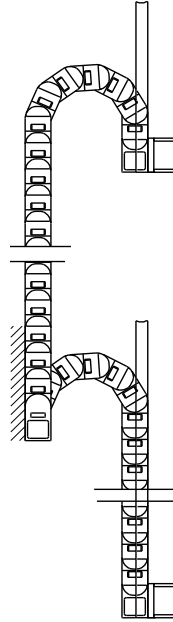

For higher E-Chain® stroke heights, it is generally recommended that at least the first three links along the outer radius be supported. For maximum heights and strokes, the whole E-Chain® must often be supported.

With lateral acceleration, the E-Chain® must be supported and, depending on the direction of this acceleration, be guided along the side

Options for a standing application with support of the first E-Chain® links: on the right, with U-shaped guidance - on the left, with the support of the first chain links

Design  
Vertical - Standing

Phone +49- (0) 22 03-96 49-800  
Fax +49- (0) 22 03-96 49-222

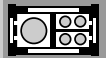
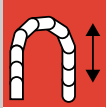



Side-mounted E-Chains® - are strongly recommended if the installation height is restricted

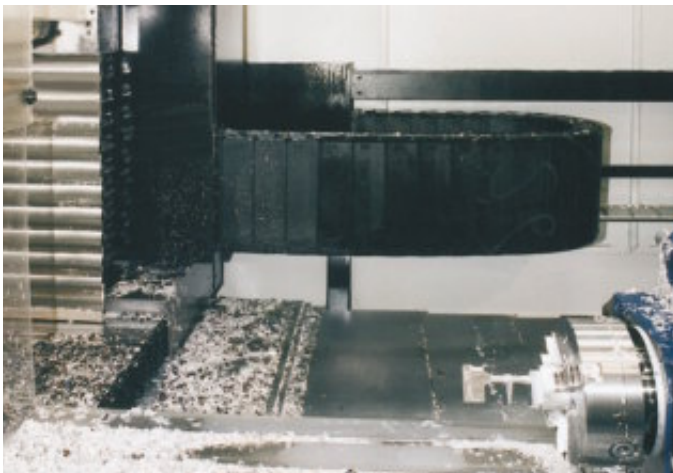

System E4 E-Tube in direct chip area E4/light



Standard values for unsupported lengths, side-mounted, upon request. The unsupported lengths can be extended by supporting the links next to the mounting brackets

### Short travels with or without support

igus® E-Chains® placed on their side can be used unsupported to a limited extent. The turned "unsupported length" in this case is dependent on the following factors: ● **Fill weight** ● **Width of the E-Chain®** ● **Bending radius** ● **Parallel placement**. The greater the fill weight of the E-Chain®, the shorter the available unsupported length. When placed on its side, the E-Chain® width, in effect, becomes the height. As this "height" increases, the E-ChainSystem® becomes proportionally more stable. Small bending radii provide greater stability. If further movement in a second axis is added to the parallel motion of two chains, the unsupported length is impaired. For applications with low fill weight, the standard mounting brackets are adequate. If, however, the fill weight is high and the travels are long, the E-Chain® must then be supported either in whole or in part. Due to the variety of application possibilities, we strongly recommend you make use of our consulting services.



igus® - Series E4/4 with partial support



Unsupported - System E4



E-Chain®, side-mounted, supported System E4

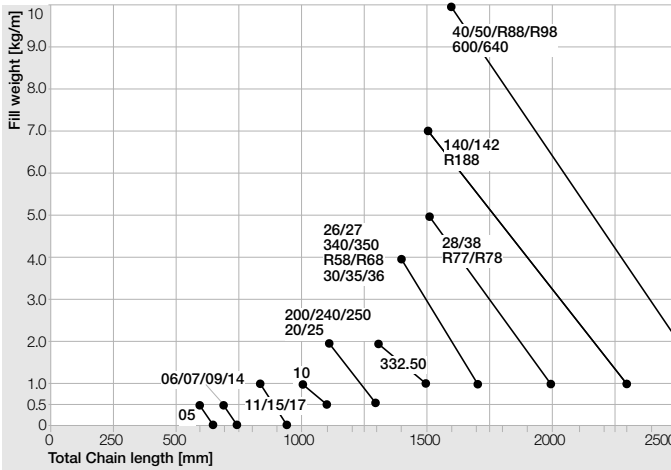

The unsupported lengths can be extended by supporting the links next to the mounting brackets



For a side-mounted gliding application, we recommend locking mounting brackets. The E-Chain® is then pushed straight through the guidance



The igus® separation elements also offer safe solutions for heavy hydraulic hoses

### Long travel, gliding

Side-mounted E-Chains® can travel over 100 m with adequate guidance. All E-Chain® types are designed to operate gliding on their side. The corresponding glide surface is usually an igus® polymer, stainless steel or galvanized steel, depending on how high the demands on the travel speed and service life are. Roller and ball bearings or additional gliding elements are not necessary for igus® E-Chains®. The diagram below shows the principle of a guide trough for side-mounted applications.

### Cables and hoses

Cables and hoses must be guided so that the E-ChainSystem® can move freely at all times. The igus® modular separation options offers numerous possibilities, such as **vertical separators and spacers**, to keep these conduits separated and bending freely for maximum service life. igus® will gladly provide an application analysis, free of charge.

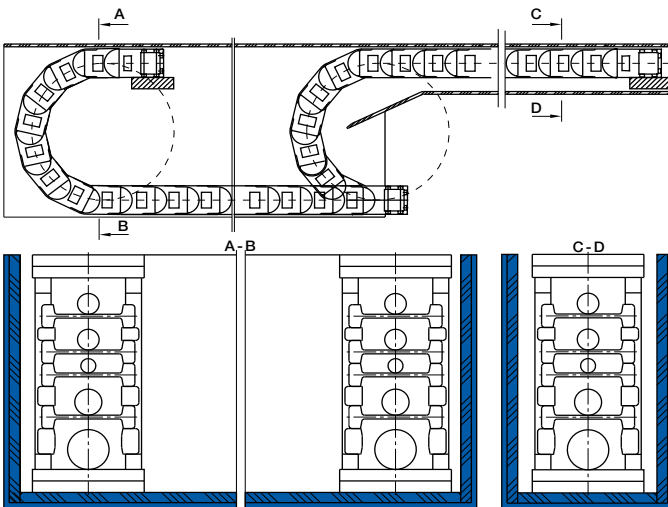

Principle of a guide trough for long travel, side-mounted



Cable and hose guidance with separators and spacers



Preferred Series for side-mounted applications

- E4/00 ▶ chapter 7
- E4/4 ▶ chapter 7
- E2 E-Tubes ▶ chapter 6

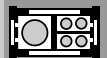
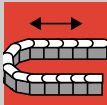



Options 2. and 3. for rotary movements require less installation height. The E-Chains® glide mostly on surfaces made of polymer, stainless steel or steel and are guided through channels into a rotary movement. (See "side mounted" for further design tips.)

Bending radii, circular radii and E-Chain® widths are variable with this product line



Rotary motion with a "standard" E-Chain®

### 1. Rotary motion with TwisterChain®

The TwisterChain® product line offers the biggest selection for rotary movements. TwisterChain® solutions are particularly recommended for space-restricted applications such as articulated robots, revolving tables, etc.

### 2. Rotary motion with standard E-Chains®

The photo to the right shows an application which was achieved using "standard" E-Chains® (in this case, standard means that the E-Chain® only bends in one direction). Such solutions are possible if a **great deal of space** is available and if the angles of rotation are limited to a maximum of 450°. All igus® E-Chains®, E-Tubes and Chainflex® cables are appropriate for this situation.

### 3. Rotary motion with "RBR"

"RBR" is "reverse bending radius" and means that the E-Chain® can bend in two directions. Each igus® E-Chain® can incorporate RBR designs, with the exception of several radii, for the E-Tubes R117 to R9850 and for the Series 07, 09, 14, 15, and 17. The RBR does not necessarily need to be identical to the normal bending radius of an E-Chain®. For example: Part No. **280.15.100/425.0**, describes a Series 280 E-Chain® with an inner width of 150 mm, standard bending radius of 100 mm and RBR of 425 mm. Most rotary motions can be achieved with the RBR option. **Angles of rotation up to 540°** have been realized. Below is an example of rotary motion using an RBR E-Chain®. Please consult igus® for your particular application.

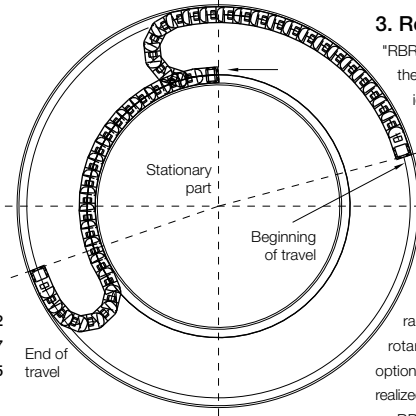

Example of a rotary motion using RBR. Here, the outer ring rotates. The inner ring could rotate just as well



Preferred Series for rotary motion applications

- All "RBR" E-Chains®
- TwisterChain® ▶ chapter 2
- System E4 ▶ chapter 7
- E2/000 ▶ chapter 5

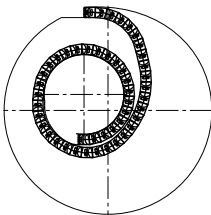
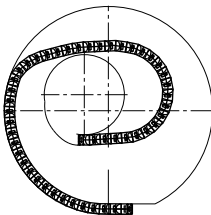

Standard E-Chain®  
3500.075.200.0,  
angle of rotation 225°

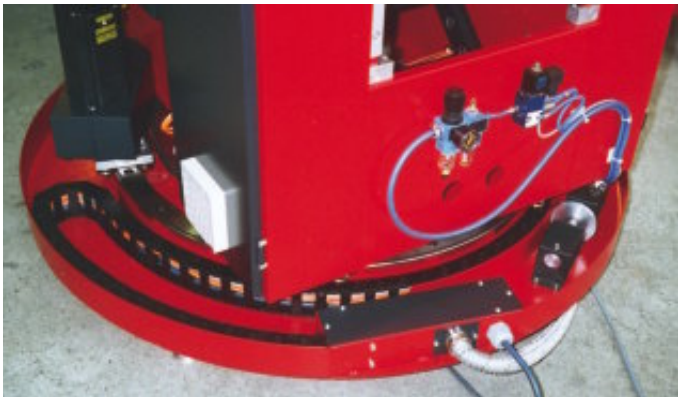

Series 255 with 360° RBR rotary motion on a robot

igus® E-ChainSystems®

Phone +49- (0) 22 03-96 49-800  
Fax +49- (0) 22 03-96 49-222

igus® GmbH  
51147 Cologne

Internet: www.igus.de  
E-mail: info@igus.de



## Guide troughs

Depending on the dynamics and load of the application, the guide troughs are made of steel or stainless steel. For applications with a high cycle frequency, we suggest coating the guide troughs with polymer. igus® E-Chains® require no additional gliding elements for contact with the base or sidewalls. igus® offers complete systems including guide troughs, but we are pleased to offer support with drawings for your own construction.



Guide troughs for rotary motion applications

## Product range

E-Chains® with "RBR" are available as standard from stock for the complete Triflex® range. In addition, we supply a number of E-Chains® which are equipped as standard with "RBR". For all other types, "RBR" means custom-made, and we will be more than willing to offer you this option. igus® E-Chains® with "RBR", available as standard **Easy Triflex®/Triflex®**.



Many igus® E-Chains® are available with "RBR" - reverse bending radius. Please note the information text of the relevant Series in the product range

Example:  
**10.4.075/220**



Technical data  
rotary motion:  
max. angle of rotation = 540°  
(larger angles possible)  
v max. = 10 m/s  
a max. = 20 m/s²

Rotary motion with RBR, diameter 6000 mm, with RBR, the inner ring rotates

## Table of "RBR" E-Chains® available from stock

Part No.	Series	chapter	Part No.	Series	chapter
06.20.018/018	E2 micro	5	10.4.075/220/1	E2 mini	5
06.30.018/018	E2 micro	5	2400.09.055/250	E2/000	5
06.64.018/018	E2 micro	5	27.07.075/300/2	E2 medium	12
08.16.038/090	E2 micro	5	27i.12.125/400/2	E2 medium	12
10.1.028/028/1	E2 mini	5	28.01.063/063	E4/0	12
10.1.038/600/1	E2 mini	5	28.02.063/063	E4/0	12
10.1.048/048/1	E2 mini	5	38.01.125/125	E4/0	12
10.1.075/220/1	E2 mini	5	38.02.125/125	E4/0	12
10.2.028/028/1	E2 mini	5	40.01.135/135/4	E4/0	12
10.2.038/600/1	E2 mini	5	40.01.200/200/4	E4/0	12
10.2.048/048/1	E2 mini	5	40.02.135/135/4	E4/0	12
10.2.075/220/1	E2 mini	5	40.02.200/200/4	E4/0	12
10.3.028/028/1	E2 mini	5	5050.01.150/150	E4/4	7
10.3.038/600/1	E2 mini	5	5050.02.150/150	E4/4	7
10.3.048/048/1	E2 mini	5	E/Z14.1.038/038	EasyChain®	3
10.3.075/220/1	E2 mini	5	E/Z14.2.038/038	EasyChain®	3
10.4.028/028/1	E2 mini	5	E/Z14.3.038/038	EasyChain®	3
10.4.038/600/1	E2 mini	5	E/Z14.3.075/075	EasyChain®	3
10.4.048/048/1	E2 mini	5	E/Z14.4.038/038	EasyChain®	3
10.4.048/400/2	E2 mini	5			

The E-Chain® Series appearing on the table are "RBR" - versions available from stock. Almost all igus® E-Chains® can be delivered as a "RBR"- version. Please contact us for any special inquiry

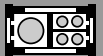





Rules for:

- Maximum conduit diameters
- Separation
- Bending radius

Electrical cables need at least 10% reserve space all around, hydraulic hoses 20%



Hydraulics and electric cables are separated from one another in this example

each conduit within the E-Chain® and the space allowed, are important for the service life of the system. Various separation options enable the adaptation of the E-Chains® to the specific requirements of each respective application. In this chapter, we give you detailed recommendations. Due to the variety of the application parameters, we strongly recommend you take advantage of our free consultation services. Simply give us a list of your cable requirements (or merely the required electrical or other services) and you will receive our recommendation by the end of the next business day.

### General rules for cables and hoses in E-Chains®

The key advantage of an igus® E-ChainSystem® is the safe accommodation of various forms of data cables and energy suppliers in one system. We recommend the optimal separation layout of the conduits in the E-Chain®, but you, the customer, are still afforded the final choice. It is possible, for instance, to maintain minimum distances between bus and motor cables and mix pneumatics, electric and hydraulics in the same compartments. In addition to the quality of the cables used, the arrangement of

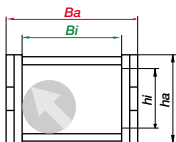

The maximum conduit diameter is specified for each Series on its respective page

### Maximum cable and hose diameters

The maximum cable and/or hose diameter corresponds to the inner height of the selected E-Chain®/E-Tube, with additional minimum clearance. This minimum clearance would be, for example, 10% for electrical round cables, 20% for hydraulic hoses. An E-Chain® is ideal if a minimum lateral gap to the next cable or hose has been factored in. Depending on the nature of the cables, the dynamics, and the expected service life, more clearance must be allowed. In specific cases, clearances may be altered further. Please consult igus.



Orderly laid cables with igus® interior separation

### E-Chain®-Distribution

Cables and hoses with very different diameters should be laid separately. The separation is achieved using modular separators. Cables and hoses must **under no circumstances** have the opportunity to tangle. Therefore, the clearance height of a compartment with several similar cables or hoses next to one another **must not amount to more than one and a half times the cable/hose diameter.**



Neatly laid cables with igus® interior separation

## Reasons for distribution rules

The cables and hoses must be laid so that they can move freely at all times and so that no tensile force is exerted at the radius of the E-Chains®. For high-speed applications and high cycles, cables or hoses must not be laid on top of each other without horizontal separation. The standard values for this are: Travel speed over 0.5 m/s and cycles over 10,000 p.a. igus® interior separation offers a safe solution for this situation.

## Further guidelines for distribution

The cable or hose weight should be symmetrically distributed along the width of the E-Chain®. Cables and hoses with different outer jacket materials must not be allowed to "stick" together. If necessary, they must be laid separately. All igus® Chainflex® cables can be combined with each and other brands of cable or hose. The cables and hoses should always be fixed at the moving end. The fixed end should always involve strain relief. Exceptions are made only for certain hydraulic hoses with length compensation issues or other high pressure hoses (i.e. hydraulic hoses). Generally, the faster and more frequently the E-Chain® operates, the more important the exact positioning of the cables and hoses inside the chain. Due to the wide variety of the possibilities, we strongly recommend you take advantage of our free consultation services for your specific applications.

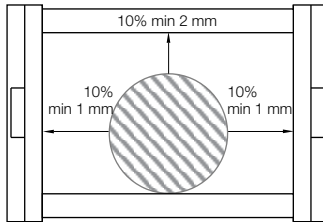
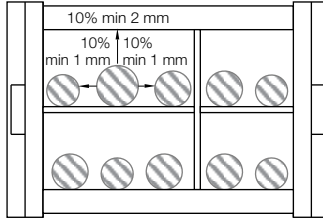
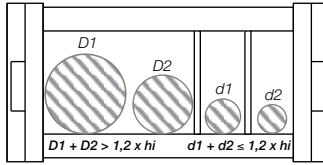

Clearance space "all around" for round electrical cables

### Distribution rules:

$$D1 + D2 > 1,2 \times hi$$

#### Rule 1:

If  $D1 + D2 > 1.2 \times$  E-Chain® inner height, no separation between the two cables/hoses is necessary. Two cables/hoses should never be left unguided on top of one another or be allowed to become tangled.

$$d1 + d2 \leq 1,2 \times hi$$

#### Rule 2:

If  $d1 + d2 \leq 1.2 \times$  E-Chain® inner height, a vertical separator or a horizontal shelf must be used to reduce the inner height, thereby preventing the entanglement of  $d1$  and  $d2$ .

### All-around clearance space in % for various cables/hoses

- Electrical round cables: 10%
- Electrical flat cables: 10%
- Pneumatics: 5-10%
- Hydraulics: 20%
- Media hoses: 15-20%

## Bending radius R

The bending radius of our E-Chain® depends on the "thickest" or "stiffest" cable or hose in your application. The bending radii of the E-Chains® should be adjusted to the recommendations of the cable or hose manufacturer.



The igus® program offers up to 12 different bending radii from stock. Here, Series 50 used in the Storebaelt bridge project

The selection of a larger radius than the minimum will positively affect service life. The specification of minimum bending radii for cables and hoses refers to use at normal temperatures - other bending radii may be recommended. Please ask your cable or hose supplier for details.

We recommend complete E-ChainSystems® - where bending radii for all cables and hoses, interior separation and service life are optimally matched.

igus® Chainflex® cables permit the smallest bending radius of 5 x d for one million strokes



Chainflex® cables - smallest bending radius of 5 x d

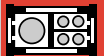
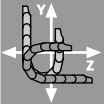



We will be pleased to provide you with recommendations for complete E-ChainSystems®: Bending radii of all cables and hoses, interior separation and service life are then optimally intermatched.



Corkscrewing: an effect of improper cable and hose placement in an E-Chain®

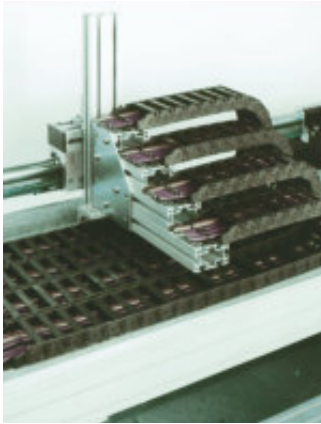

Example from igus® test laboratory: continuous development and testing of Chainflex® round electrical cables

## Round electrical cables

For electrical cables, the round cable is a safe, modular and cost-effective solution for E-ChainSystems®. We recommend the following criteria for selecting the proper round electrical cables:

- Small minimum bending radii and mounting heights
- Strain relief integrated directly into the mounting bracket
- Uncomplicated installation process - no hanging, laying out, etc. of cables
- Long service life at minimum bending radius
- Service life expectations for your application (short or long travel, hanging, etc.)
- Test data on service life from realistic tests
- Flexible shields for shielded cables
- Abrasion-resistant and non-adhesive outer jackets
- Large selection to avoid expensive custom designs. For bus cables and fiber optic cable, special attention must be paid to how effective transmission rates and shielding remain after millions of cycles at the minimum bending radius.

## Installation and strain relief of round electrical cables

- 1** The cables must be laid straight, without twisting. Cables must not be uncoiled from the top of the spool. igus® Chainflex® cables are immediately ready for placement directly into the E-Chain®. They need not be disconnected or laid out before installation.
- 2** The cables must be laid so that each individual cable can move freely from side to side.
- 3** The cables must be able to move freely along the radius. This must be double-checked if the upper run operates at the cable's maximum bending radius.
- 4** The division of the E-Chain's® interior using shelves or igus® interior separators is necessary if several cables and/or hoses with varying diameters are laid out. It is important to prevent cables and hoses from tangling.
- 5** For cables and hoses with different jacket materials, it is important to prevent them from "sticking" to one another. If necessary, they should be separated. igus® Chainflex® cables can be combined with all others.
- 6** Round electrical cables must be secured with strain relief at both ends. In exceptional cases, the cables may be fixed with strain relief at the moving end of the E-Chain® only. A gap of 10-30 x cable diameter between the end of the bending segment and the fixed point is recommended for most cables. Chainflex® cables can, on the other hand, be secured directly to the mounting bracket with strain relief (this has been confirmed with testing).

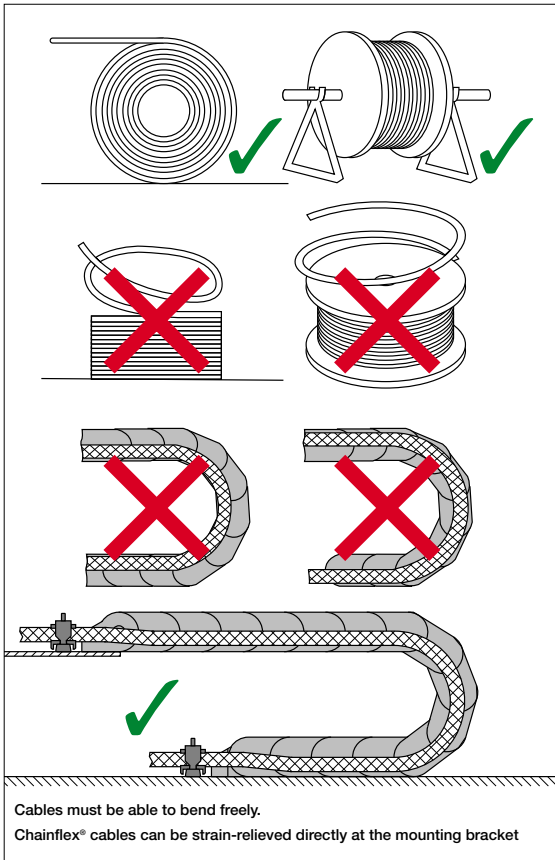

Cables must be able to bend freely.  
Chainflex® cables can be strain-relieved directly at the mounting bracket

igus® E-ChainSystems®

Phone +49- (0) 22 03-96 49-800  
Fax +49- (0) 22 03-96 49-222

igus® GmbH  
51147 Cologne

Internet: www.igus.de  
E-mail: info@igus.de

## Pneumatic hoses

In principle, the same rules apply for pneumatic hoses as for round cables. In practice, it has been demonstrated that pneumatic hoses are less susceptible to wear. After consultation, they can be laid together more closely than the "10% clearance all-around" rule. A double-sided strain relief is required under these conditions. For pneumatic hoses made of rubber, we recommend strictly following the "10% clearance" rule because they tend to adhere to each other and to other conduits.



Fully pre-assembled E-ChainSystem® with several pneumatic hoses



The igus® program also offers polymer pneumatic hoses called: "Chainflex® Air"

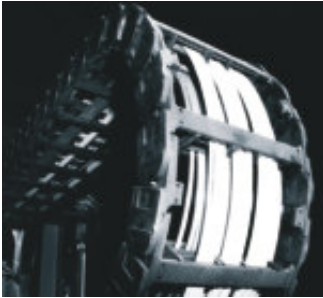

Flat cables and pneumatic hoses installed in an E-Chain® with full interior separation

## Flat cables

Flat cables must be able to move freely along the bending radius. Two flat cables next to one another should be kept apart with separators. If two flat cables are laid on top of one another, we strongly recommend the use of horizontal igus® shelving. Flat and round cables should be laid separately in the E-Chain®,. Strain relief should be attached at both ends. Flat cables are only conditionally recommended for use in E-Chains®.

**Flat cables** - Outer jackets made of rubber must be specified particularly carefully, because of potentially high static friction.

## Hydraulic hoses

When designing hydraulic hoses in E-Chains®, special attention should be paid to the expansion of the hoses when pressurized. Sufficient room must be left in the E-Chain® for this as well as the possible larger external diameter of the hoses under pressure. It is important for selected hoses to be sufficiently flexible (i.e. meet bending radius specified by the E-Chain®). The gliding ability and abrasion-resistant surface of the hoses are also important. All crossbars and shelves in the igus® E-Chain® minimize abrasion of hoses through wide, rounded and smooth surfaces. Normally, hoses with textile braiding are more flexible than hoses made of steel wire, while maintaining smaller outer diameters and better fatigue strength under reverse-travel stresses. As lateral movements of the hydraulic hoses within the E-Chain® can lead to increased abrasion of the hose material, they should be secured in position with vertical separators, but not forced. Special "locking" separators, which grip the opening crossbars of the chain, as well as the use of "spacers," prevent lateral shifting of the separators - they also ensure the hoses stay put in cases of strong vibration and impact on the chain.



igus® E-Chains® with hydraulic hoses in a tree-stripping machine



**Hydraulic hoses need more space:**  
20% all-around clearance

**Strain Relief** - Hydraulic hoses are most often stretched lengthwise during operation. This must be taken into account when applying strain relief. More hose length is factored in to allow the hose to "breathe", or "floating" strain relief must be implemented. In some cases, one-sided strain relief on the moving end can be tolerated.

**Rollclip** - In almost all cases, the broad, smooth and rounded surfaces of all igus® E-Chains® are sufficient to protect hydraulic hoses from abrasion. In extreme cases, the igus® Rollclip can be installed. The hoses come in contact with a series of polymer cylinders which rotate. "Extreme" cases include particularly soft materials, particularly narrow bending radii or highly dynamic loads. Over 95% of all applications can be solved without Rollclips.



igus® Rollclip, detachable

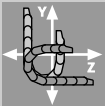





Ideally, the cables/hoses should be strain relieved at both ends of the E-Chain®. At the very least, they must be strain relieved at the moving end of the E-Chain®.

For more information on all igus® strain relief elements  
► chapter 9

igus® E-ChainSystems®

Phone +49- (0) 22 03-96 49-800  
Fax +49- (0) 22 03-96 49-222

igus® GmbH  
51147 Cologne

Internet: www.igus.de  
E-mail: info@igus.de



Strain relief in KMA mounting bracket with C-profile

### Strain relief for electrical cables

Strain relief can consist of standard elements or can be custom-made. For most applications, our standard program of C-profiles with mounting brackets and space-saving Chainfix clamps can be used. We also offer simple strain relief solutions using cable tiwraps and tiwrwrap plates. In ideal cases, the cables should be secured at both ends of the E-Chain® with strain relief (in a few instances, strain relief at the moving end of the E-Chain® is sufficient - please consult igus® for these cases).

### Minimum gap of the strain relief and the beginning of the bending radius

Tests on our premises and in field applications have shown strain relief located at the last bending point of the E-Chain® has no influence over the durability of igus® Chainflex® cables. It is possible, therefore, to integrate the strain relief with the mounting bracket. This space-saving option for strain relief is offered by igus® for almost all E-Chains®.

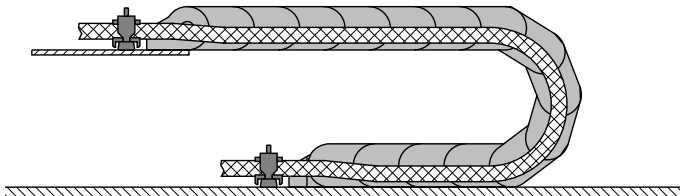

Ideal installation of cables in E-Chains®. Chainflex® cables can be directly strain-relieved in the mounting bracket (minimum gap to the last curved E-Chain® link is not necessary)!



Chainfix strain relief in mounting bracket in practice - used here for cables and hoses

**Features of chainfix clamps**

- Optimal igus® Chainfix housing with reduced height
- Long service life for dynamic applications thanks to improved clamping elements
- Integration with KMA mounting brackets - saves both time and space during installation and available for complete systems with cables and strain relief
- Improved housing foot clamp for easy fit into C-profile
- Black housing and setscrews for attractive appearance
- Setscrews, tightened with Allen wrench, for easy installation.

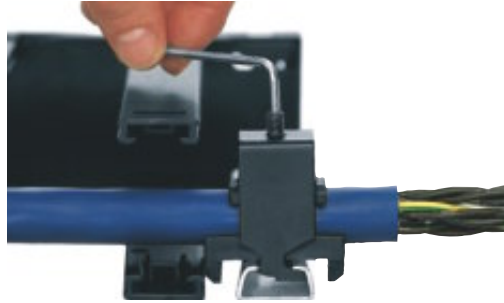

**Chainfix clip - modular snap-on strain relief device**

Chainfix clip is a series of clamps and bottom parts made of plastic for cable diameters ranging from 4 mm to 24 mm. Chainfix Clip is available for C-profiles, also suitable for assembly in the KMA mounting brackets and clip-on strain relief for cross bars.

- Features:**
- Quick assembly without any tools
  - 2 and 3 layers on top of one another possible
  - Each layer can be detached and changed later on
  - High tensile forces in case of single-layer installation, decreasing with the number of layers



**Tiewrap plates with clip-on connection for the C-profile**

The plates **3050.ZC** and **3075.ZC** can be clipped directly into the C-profile without bolts or any extra hardware. Clip-on tiewrap plates can be released and repositioned with just a screwdriver used as a lever.

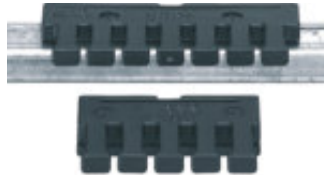

**Tiewrap plates as individual parts**

- Suitable for:**
- Separate parts in switch cabinet construction or machine assembly
  - Strain relief accessory for igus® E-ChainSystems®
  - Attachment to mounting brackets
  - Integration into the C-profile of KMA (polymer/metal mounting brackets)



**Strainrelief separator**

- Can be integrated in mounting bracket
- Strain-relief separator can be positioned as required
- Double strain relief possible
- Easy installation, cost-effective
- For Series E6.29, 2600/2700 (other Series upon request)



Design  
Strain Relief

Phone +49- (0) 22 03-96 49-800  
Fax +49- (0) 22 03-96 49-222

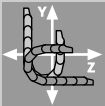



igus® E-ChainSystems®

Phone +49- (0) 22 03-96 49-800  
Fax +49- (0) 22 03-96 49-222

igus® GmbH  
51147 Cologne

Internet: www.igus.de  
E-mail: info@igus.de



**Technical environment:**

- Fire resistance
- Radiation
- Weathering
- Cold, heat
- Explosion areas
- Vacuum
- Hot chips
- Dirt, dust
- Cleanroom
- Chemicals



igus® factory - automatic compounding and conveyor belt for igumid G

**Technical environment and igumid G**

The igumid G material, from which igus® E- Chains® are made, possesses the following wide-ranging features to cope with a variety of environments: the ability to handle pressure and strenuous loads, abrasion resistance, sturdiness, stable behavior at high and low temperatures, and suitability for outdoor use. Numerous application examples, from refrigerator blocks to steel mills, prove this. In extreme cases, we also offer modifications and other igus® compounds as a solution. Please consult igus®.

**Resistance to radiation**

igumid G is very resistant to high-energy radiation. Under gamma radiation, in the range of  $8 \times 10^4$  rd, the mechanical properties of igumid G change very little.

**Flammability of igumid G**

The flame-retardant characteristics of igumid G can be described using various classifications: Test procedure VDE 0304 parts 3-5.70 - classification Ilc. Tested according to UL 94 "Standard Tests for Flammability of Plastic Materials for Parts in Devices and Appliances" classification 94 HB for 3.2 and 1.6 mm thickness of the body. Tested according to DIN 4102 "Fire Behavior of Building Materials and Parts" classification materials class B-2. For further requirements, please consult igus® for special solutions, such as materials with self-extinguishing properties (UL V2 or UL V0). All E-Chains® (except for the Easy Chains® and Series 14) are made of from igumid G.



igumid G has the classification UL 94 HB.  
igumid NB has the classification UL 94 V2. UL 94 V0 upon request



igumid G:  
UL 94 HB

igumid NB:  
UL 94 V2  
UL 94 V0

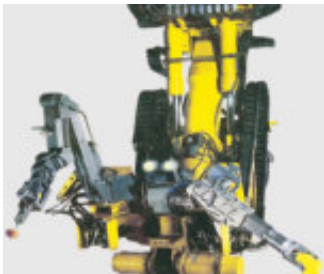

This robot is used for test purposes in British nuclear power plants

**Flammability of igumid NB**

All Easy Chains® and Series 14 Chains are made from the flame-retardant igumid NB material. These chains have the following flame-retardant classifications: ● UL 94 classification - V2 ● VDE 0304 Parts 3-5.70 classification - Ilb ● DIN 4102 flammability of materials - B2 ● Please consult igus® regarding material availability "V0"

**Temperature resistance**

igumid G is very suitable for outdoor applications. In our experience, the mechanical properties of the E-Chain® are not impaired. igumid G is also UV-resistant. igus® E-Chains® are used in applications as cold as -40°C. Installation may be eventually compromised at temperatures below -25°C. In such cases, we offer special solutions made from cold-elastic materials. 130°C continuous temperatures are possible. However, the mechanical values are reduced and the service life is impaired.



Live broadcast from the Winter Olympics in Lillehammer - 75 m travel at -25°C



igumid G - UV-resistant.  
Temperature range from:  
-40°C to +130°C



**ESD & ATEX**

Special ESD products and ESD tools must be used in numerous industrial sectors in order to protect sensitive electronic components against electrostatic discharge. Consequently an electrostatic discharge function applies in particular to energy ducting systems with their central role in automated sequences. igus® has developed the ESD E-Chain® for these demanding applications. They are made of material igumid ESD which immediately discharges per-

manent electrostatic charges in controlled manner. igumid ESD consists of the igus® E-Chain® material which has been tried and tested for over 30 years now in millions of applications with special additives. These additives provide the required properties and, in **mechanical** requirements, even exceed the standard material. Thus, for instance, the somewhat higher rigidity and the approx. 15% lower density can be used to implement a longer unsupported length, depending on application. The ESD E-Chain® features an even longer service life owing to the material. Unlike temporarily acting, applied conductive coatings or volatile, incorporated antistatics, the additives used provide durable and "maintenance-free" conductivity. One other advantage is the resistance to adverse ambient conditions.



**More ESD and ATEX information:**  
[www.igus.de/atex-esd](http://www.igus.de/atex-esd)



**The hue of igumid ESD approximately corresponds to RAL 7015 slate-gray**



igumid ESD with PTB certificate - We have received an official comment from the German National Standards Laboratory (PTB) on material igumid ESD and we are able to provide you with a copy on request

**System E6 - 2nd Generation ESD Chains without pin and bores, long-term conductivity guaranteed**

For many years, safety in hazardous areas and ESD protection in sensitive production areas have been given high priority at igus®. Since 1992, E-Chains® have been manufactured from our special "GC" material. Certified 12 years ago by PTB (German federal office for Physics and Technology), the material was modified in 2002. In spite of homogeneous conductivity of the material, common pin/bore design chains can hardly maintain their conductivity within normed conductivity tolerances in the long term. ● Constant long term conductivity values ● No contact surface wear ● Proven standard product, now also conductive ● Cycle life in lab test ≥10 Million cycles (more upon request) ● Underlies heightened QC procedures, with and without mounting brackets and in various install modes ● IPA Fraunhofer institute certifies "Level 1" discharge performance, acc. to SEMI E78-0998 ESD, even for off-the-shelf standard E6 material.

Design  
Technical Environment

Phone +49- (0) 22 03-96 49-800  
Fax +49- (0) 22 03-96 49-222

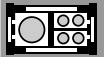
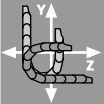

## igus® goes clean room - qualification of E6 and other igus® E-Chains®

In many applications where cumbersome special solutions are used, a simple standard E-Chain® can be used instead. A comprehensive test program was devised and performed for both gliding use and unsupported use. For many applications, the E-Chains® in special materials are practically abrasion-free. Detailed test results are available upon request. IPA tests confirm that standard igus® E-Chains® meet clean room requirements. "Tested and certified as very good!" E-Chains® for clean room applications on the test stand Clean room environments demand very high wear resistance of moving parts. E-Chains®, for example, must be very wear resistant, in order to meet norm requirements for such a sensitive environment.

IPA Fraunhofer Institute has tested igus® Series E3, E4, E6 and EasyChain® as follows:

- ISO class 1, as per stringent norm DIN EN ISO 14644-1 for System E3, Series E3.15.040.075.0 at v = 0,5 m/s, 1 m/s, 2 m/s
- ISO class 1, as per stringent norm DIN EN ISO 14644-1 for System E6 - special material\*, Series E6.29.060.150.0 at v = 0,5 m/s, 2 m/s
- ISO class 3, as per stringent norm DIN EN ISO 14644-1 for System E6 - standard material, Series E6.29.060.150.0 at v = 0,5 m/s, 1 m/s, 2 m/s
- ISO class 2, as per stringent norm DIN EN ISO 14644-1 for Series EasyChain® E14.3.038 at v = 1 m/s
- ISO class 3, as per stringent norm DIN EN ISO 14644-1 for System E6, Series E6.29.050 at v = 1 und 2 m/s
- ISO class 4, as per stringent intensified norm DIN EN ISO 14644-1 for System E4, Series 280.100 at v = 2 m/s

### Test setup: Particle generation measurement



Measurement result: Particle generation E14.3.038.0

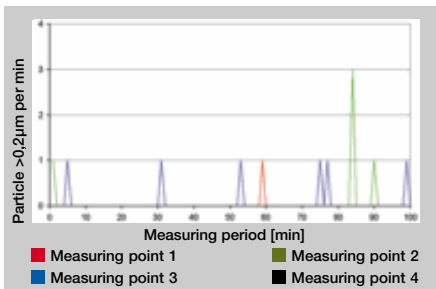

### ISO Class 2

acc. to DIN EN ISO 14644-1  
for E14.3.038.0

### Test setup: Field strength measurement



Measurement result: Field strength E6.29.050.055.0

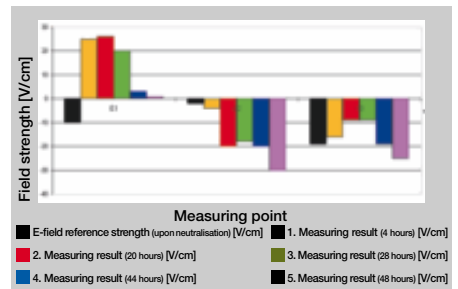

### Level 1

ESD-compatibility acc. to SEMI E78-0998  
for E14.3.038.0 and E6.29.050.055.0

### Classification chart

Class per DIN	Equivalent to VDI 2083	Equivalent to US Fed.Std. 209E	Classification Series	Speed [m/s]
EN ISO 14644-1	VDI 2083	US Fed.Std. 209E		
ISO class 1	no comparable classification	no comparable classification	E3.15.040.075.0	0,5 / 1,0 / 2,0
ISO class 1	no comparable classification	no comparable classification	E6.29.060.150.0*	0,5 / 2,0
ISO class 2	no comparable classification	no comparable classification	E14.3.038.0	1,0
ISO class 3	class 1	class 1	E6.29.060.150.0	0,5 / 1,0 / 2,0
ISO class 4	class 2	class 10		
ISO class 5	class 3	class 100		
ISO class 6	class 4	class 1.000		
ISO class 7	class 5	class 10.000		
ISO class 8	class 6	class 100.000		

\*special material\* "clean room"



Fraunhofer  
Institut  
Production technology  
and automation



igus® E-Tubes in the chip area of machine tools

### Splatter, hot chips

Laboratory tests and numerous field applications prove that igus® E-Chains® and E-Tubes reliably protect cables in welding robots and machine tools. Although welding spatter leaves some visible traces, it does not impair the material or the function. igus® E-Tubes have successfully withstood tests at 1,652°F (900°C) with medium-sized hot metal chips. They are in use worldwide in the chip area of machine tools (Please note: igumid G in direct contact with large amounts of melted aluminum is not recommended.).



Also hot asphalt is no problem for igus® E-Tubes, Series R48

### Dirt, dust, chips

Materials and design make igus® E-Chains® excellent problem-solvers in harsh environments. Experience and application references are available upon request. Please consult igus® with your application.

### Vacuum

igus® E-Chains® made of igumid G can be used in vacuum applications. Very little outgassing occurs.

### Chemical resistance

igumid G is resistant to fuel, lubricants, oils, fats, alcohol, ester, ketone, and aliphatic and aromatic hydrocarbons. Oxidants and acids are damaging. The table ► page 1.40 shows an excerpt of the precise details concerning resistance to chemicals. Acid-resistant E-Chains® are available upon request.

### Coolant resistance

E-Chains® and E-Tubes have proven **resistant to cooling agents**. However, we are always willing to perform individual tests if you have particular problems or advanced developments. **Table on resistance to chemicals** ► page 1.40.



Compost sludge - numerous related references available upon request



Tests with 900°C hot chips

### igus® - Experience with

Dust, dirt, mud, compost, wood, textile fibers, paper dust, abrasive paste, cooling agents, glass dust, glass splinters, coal dust, sand, corundum and much more.



Particularly suitable E-Chain® Series for dirt, dust, chips

- System E4 ► chapter 7
- E2 E-Tubes ► chapter 6
- E2/000 ► chapter 5

Design  
Technical Environment

Phone +49- (0) 22 03-96 49-800  
Fax +49- (0) 22 03-96 49-222

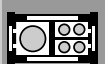
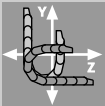



## Plastics for longer life® - igus® know-how in polymer materials

Each year, igus® engineers develop more than one hundred new plastic compounds and test igus®-products in more than 5,000 experiments per year. That's how in recent years they have built an extensive database of the tribological properties of polymers. This database makes it possible for us to assess better most of the applications in advance and provide our customer with confidence during use. Our calculations and analyses are based on the result of ongoing practical tests in our Technical Center and our experience with gliding applications. The focal points of our tests are push-pull forces, friction values and abrasion under widely varying conditions and speeds, as well as factors such as dirt, weathering or impact and bumps. We test all system components such as cables, hoses, strain relief and other accessories, in addition to the E-Chains® or E-Tubes and Guide Troughs.



### Material data igumid

Material data table	Units of Measure	Values igumid G	Values igumid NB	Values igumid ESD	Values igumid TE
Yield stress	MPa	190/130	78/40	-	-
Elongation at break	%	004/006	20/210	-	-
Elasticity module (tensile test)		9000/7000	2900/1200	-	-
Impact strength +23°C	kJ/m²	55/65/55	not broken	-	-
Impact strength -40°C	kJ/m²	40	90	-	-
Ball indentation hardness H 961/30		230/160	150/60	-	-
Heat conductivity W/k * m	Ω/k * m	0,23	-	-	-
Dielectric constant	10 <sup>9</sup> Hz	3,9/6,2	-	-	-
special transitional resistance	Ω*cm	>10 <sup>11</sup>	>10 <sup>11</sup>	<10 <sup>9</sup>	-
Impact strength density 0,6-0,8 mm	kV/mm	80	16-18	-	-
Surface resistance ROA	Ω	>10 <sup>11</sup>	>10 <sup>11</sup>	<10 <sup>9</sup>	-
Density	g/cm³	1,37	1,14	1,2	1,02
Absorption of humidity 23/50 RF	%	1,4	3,4	1,9	1,1
Coefficient of sliding friction	-	0,3	0,3	0,3	0,3
Fire resistance as per VDE	-	FH2	-	-	-
Fire resistance as per UL	-	94 HB	94 V-2	HB	HB
Color	-	■ = RAL 9004	■ = RAL 9004	■ = RAL 7015	■ = RAL 9004
Maximum water absorption	-	5,6	7,6	7,3	-
Limit of elasticity in bending	-	7.800 MPa	3.000 MPa	9.500 MPa	-
Bending strength	-	240 MPa	120 MPa	230 MPa	-
Hardness Shore D	-	79	79	83	-
Upper long-term application temp.	-	120°C	80°C	80°C	70°C
Upper short-term application temp.	-	180°C	170°C	150°C	140°C
Lower application temp.	-	-40°C	-40°C	-40°C	-40°C

Medium	Concentration Weight %	Material igumid G /NB
Acetone	100	+
Formic acid (aqueous)	2	○
Ammonia (aqueous)	10	+
Gasoline	100	+
Benzole	100	+
Bitumen	100	○
Boric acid (aqueous)	10	+
Butyric acid	100	○
Calcium chloride (aqueous)	Sat. aq. sol.	+
Chlorinated hydrocarbons		+
Chlorine water	Sat. aq. sol.	-
Chromic acid (aqueous)	1	○
Diesel oil	100	+
Iron II cyanide	30	○
Acetic acid	2	+
Color		+
Fats, cooking		+
Fluorinated hydrocarbons		+
Formaldehyde (aqueous)	30	○
Hydraulic oils		+
Caustic potash	10	+

**Resistance classes**

- + = resistant
- = conditionally resistant
- = non-resistant

Medium	Concentration Weight %	Material igumid G /NB
Potassium carbonate (aqueous)	60	+
Potassium sulphate (aqueous)	100	+
Methyl acetate	100	+
Milk		+
Mineral oil		+
Sodium carbonate (aqueous)	50	+
Oil, cooking		+
Oil, lubricating oil		+
Oleic acid	100	+
Paraffin oil		+
Perchloroethylene	100	+
Polyester resins (with styrene)		+
Propane gas		+
Mercury		+
Hydrochloric acid	pH2	○
Hydrochloric acid	2	-
Hydrochloric acid	10	-
Ink, printing ink		+
Vaseline		+
Tartaric acid		○
Zinc sulfate (aqueous)	10	+

**Sat. aq. sol.** = saturated aqueous solution

**Conc. aq. sol.** = concentrated aqueous solution

The values specified are values determined by laboratory tests and are material-specific. All specifications apply to black E-Chains®.

**Colors and special solutions**

All E-Chains® made from igumid G are available in the colors listed below. Additional colors are usually feasible. Colored E-Chains® are basically not available from stock. Contact igus® for more information regarding colored E-Chains®. All values listed apply to stability (e.g. unsupported lengths) and material characteristics for black E-Chains® only. Colored E-Chains® may have altered characteristics. This also applies for all E-Chains® made from special materials (e.g. conductive E-Chains® made from igumid GC or other special materials).

**"RAL" Numbers**

	Black	≈ RAL 9004	Index .0
	White	≈ RAL 9003	Index .1
	Violet	≈ RAL 4008	Index .5
	Yellow	≈ RAL 1018	Index .4
	Orange	≈ RAL 2003	Index .2
	Red	≈ RAL 3002	Index .6
	Blue	≈ RAL 5005	Index .8
	Green	≈ RAL 6011	Index .7
	Grey	≈ RAL 7023	Index .3 for Chains
	Dusty grey	≈ RAL 7037	Index .3 for Tubes
	Agate grey	≈ RAL 7038	Index .11
	Light grey	≈ RAL 7035	Index .14
	Black grey	≈ RAL 7021	Index .13
	Slate grey	≈ RAL 7015	only ESD-E-Chain®
	Yellow/black	-	Index .9



Colors for design coding

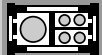
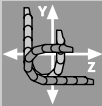





Quality inspection of every E-Chain® production



Test location for ESD-E-Chains®



Chainflex® cables with many certificates for e.g. DESINA

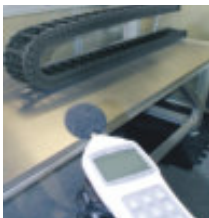

Noise level tests in igus® own acoustic laboratory

## Examples for test certificates and approvals

### ISO 9001

igus® has been certified since November 1996

### TÜV construction test

igus® E-Chains® and E-Tubes are construction-tested by TÜV Rheinland. igus® E-Chains® were tested and passed by TÜV Rheinland in accordance with the valid machine guidelines. As a result, the user of igus® E-Chains® need not worry about meeting CE requirements through testing for this portion of the machinery. **The construction test 2PFG 1036 / 10/97 for protective equipment includes the following:**

- Application and safety
- Assembly
- Fatigue strength
- Resistance to external influences
- Sharp corners and edges

### ESD/ATEX

igus® E-Chains® made of standard material igumid G correspond to the German federal office of Physics and Technology (PTB) to classification Ex II 3 GD according to ATEX-RL 94/9/EG. igus® E-Chains® made of igumid ESD correspond according to the German federal office of Physics and Technology (PTB) to classification Ex II 2 GD according ATEX-RL 94/9/EG.

### IPA Cleanroom

A lot of E-Chains® are suitable for the use in cleanrooms according to DIN EN ISO 14644-1. Confirmed by the IPA Fraunhofer Institute.

### UL, CSA, CEI, CE and VDE

All igumid-materials for E-Chains® and E-Tubes have got the UL-material approval. The material igumid NB has got the fire protection class approval IIb according to the test VDE 0304 Part 3/5.70, the approval V2 according UL 94 and the construction material class B2 according DIN 4102.

### Interbus and DESINA

Chainflex®- cables are produced according to a lot of international standards: **Interbus certification:** For Interbus certification of certain CF11 bus cables. **DESINA:** Many Chainflex® cables are Desina-compliant.

### Clearly quieter

igus® E-ChainSystems® are clearly quieter. In the acoustic laboratory of the TÜV and the igus® GmbH different E-Chains® were compared. The igus® Systems E3, E6 and E4/00 (Series E4/101) are measurably (and clearly) quieter than other products of comparable size (see also noise-optimized E-Chains® ► [page 1.11](#))

### igumid

The material igumid is free from toxins, according 2002/95/EC (RoHS).

### iF Design Award

14 iF Design-Awards since 1984



# ReadyChain<sup>®</sup>

Plug and play E-ChainSystems<sup>®</sup>

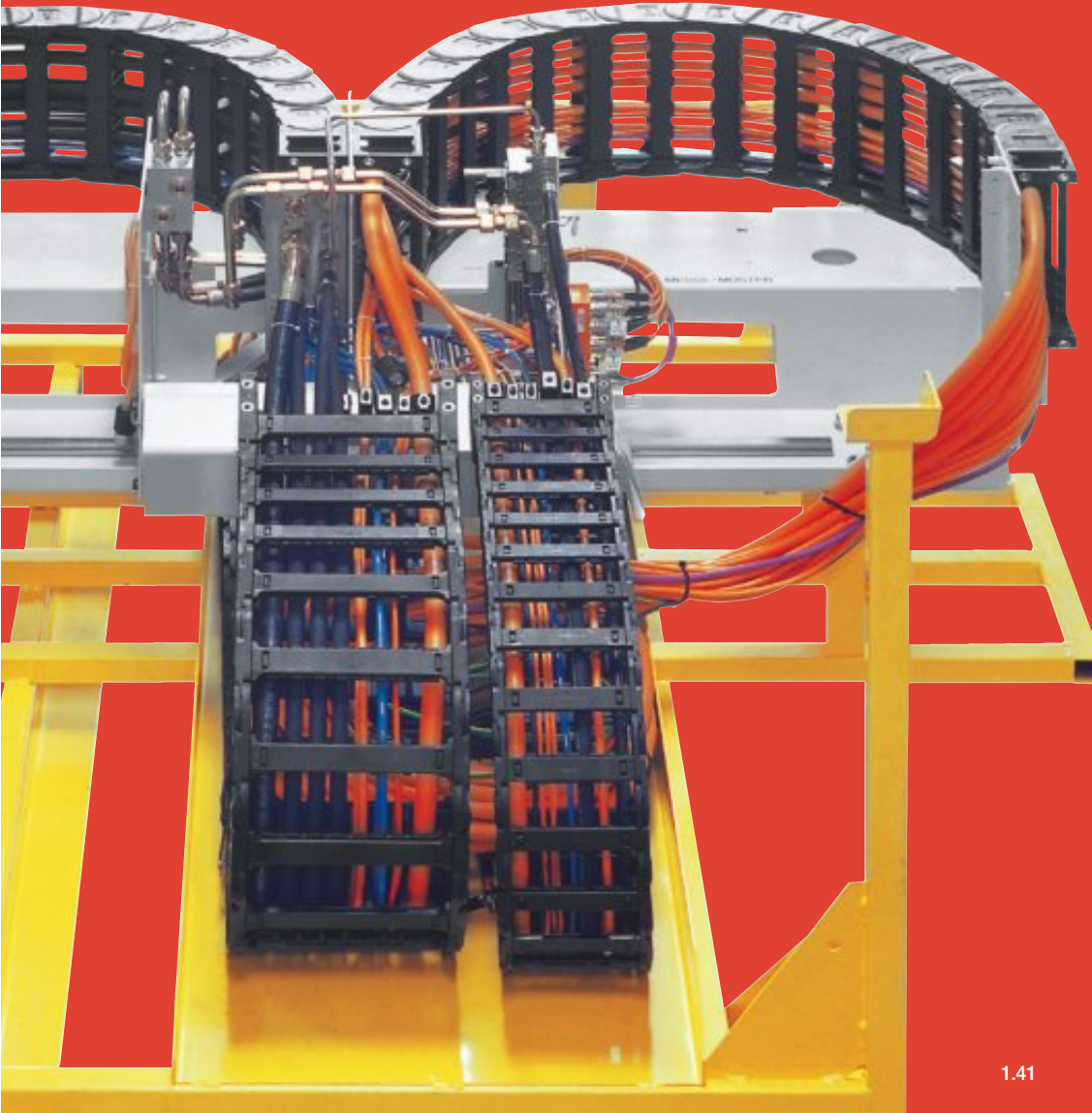

### The advantages of plug and play E-ChainSystems® from igus

- Increase your cash-flow
- Cover the fluctuations
- Reduce your throughput
- Minimize downtime
- Reduce number of purchase orders by about 75%
- Zero stock
- Modern equipment means low cost at highest quality
- Any system is checked in our test center
- More than 3,000 electrical components from stock
- Delivery with individual Plates and mounting parts
- igus® is certified according to DIN EN ISO 9001:2000
- ReadyChain®-factory with more than 80 experts
- Over 700 systems leave the 10 ReadyChain® factories worldwide every week
- Profit from our long experience acquired since 1993
- Worldwide service in more than 45 countries

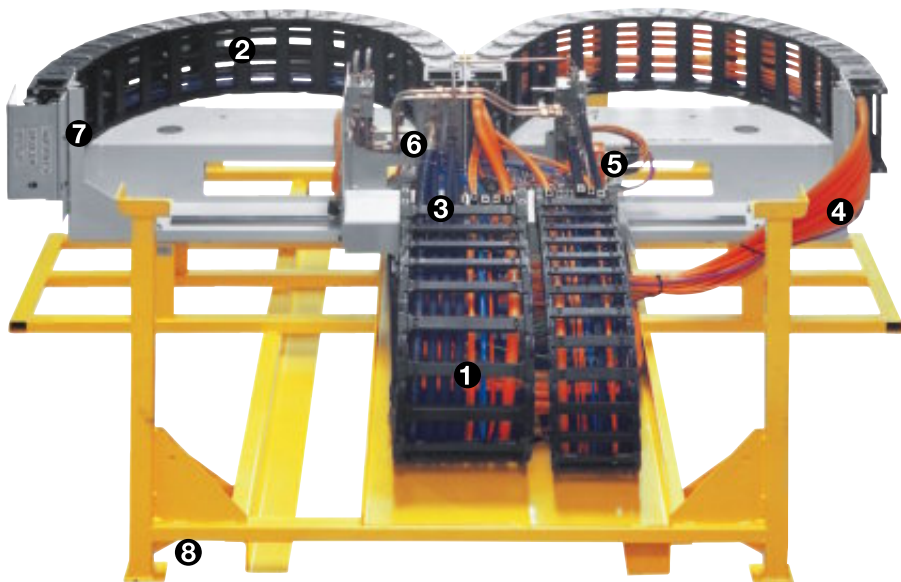

- |  |  |
|--|--|
| <p><b>1</b> Ordered cables and hoses within the E-Chain® using separators and shelves from igus®</p> <p><b>2</b> E-Chain®, specially designed for your machine</p> <p><b>3</b> Strain relief systems, specially designed for use in your machine</p> <p><b>4</b> Special cables and hoses, designed for E-Chains® and suited to your application</p> | <p><b>5</b> Connector components, preassembled according to specification standards of Siemens, Fanuc, SEW, etc.</p> <p><b>6</b> Hydraulic components, designed for your application</p> <p><b>7</b> Plates and mounting parts, optimized for the quick installation on your machine. Delivered ready to install.</p> <p><b>8</b> Installation and transport racks</p> |
|--|--|

### igus® ReadyChains® increase your cash-flow

Whether major projects or simple, assembled E-Chains® - we save you costs, time and hassle through igus® ReadyChains®. Over 700 systems leave the 10 ReadyChain® factories worldwide every week. Profit from our long experience acquired since 1993, and increase your cash flow quickly and smoothly even for one-off systems.

- 1** **Zero stock of cables, E-Chains® and connectors** - Forget storage of flexible cables, connectors and other parts with our fast delivery times. **Detailed information ► page 1.44**
- 2** **Reduce throughput time by about 50%** - igus® delivers ready-made systems worldwide within 2-8 days of the guaranteed date. **Detailed information ► page 1.45**
- 3** **Respond flexibly to order fluctuation** - With ReadyChains® you are always prepared for variations in demand. We help cover the fluctuations. **Detailed information ► page 1.46**
- 4** **Minimize downtime** - Small things can cause big problems. Buying numerous single parts increases your inventory and the chances of problems. You will get a system solution with ReadyChains®. Any system is checked in our test center. igus® is certified according to ISO 9001. **Detailed information ► page 1.47**
- 5** **Reduce number of suppliers and purchase orders by about 75%** - One order one invoice one delivery one partner. Don't care about looking for numerous parts from numerous suppliers. We have the knowledge to provide you quickly with the optimal parts. **Detailed information ► page 1.48**

## You determine the degree of harnessing



### Any degree is possible

We harness from simple E-ChainSystems® with pre-fitted Chainflex® cables to complex systems. These systems may include all cables and hoses (pneumatic, hydraulic), patch plugs, inner partitions, connecting elements and connecting parts as required.

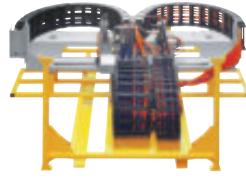

From easy ..... to project

## You determine the size



### Any size is possible

Because of our upto-date production processes we can deliver fast and cost effective custom build or serial production products.

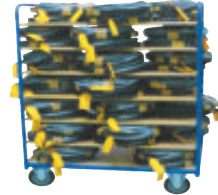

From one-off ..... to serial production

## You determine the travel length



### Choose the travel length

ReadyChains® offers the whole spectrum of possible travels of the igus® E-Chains®. We harness anything from short to long travels. Safe transportation guarantees damage-free delivery of any lengths.



From short ..... to long

## Standardised ReadyChain®: Ready to fit

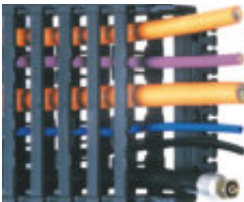

### ReadyChain® "Basic"

Simple, prefabricated E-ChainSystem® including assembled cables without connectors, labelled and according to your specifications.

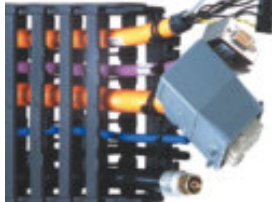

### ReadyChain® "Standard"

Simple, prefabricated E-ChainSystem® including assembled cables with all connectors, labelled according to your specifications

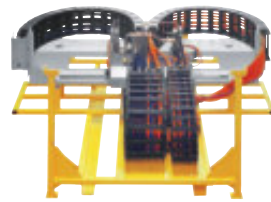

### ReadyChain® "Premium"

A prefabricated E-ChainSystem® with cables of all kinds, as well as plugs, connectors and components according to your specifications. Special shafts and plain bearings machined according to your specifications.





## 1 Reduces your storage costs to zero for cables, E-Chains® and connectors

In Cologne, igus® manufactures its products on about 25,000 m<sup>2</sup> interior space. 80,000 products delivered off the shelf. Reduce your capital commitment and increase your cash flow with igus® ReadyChain®. Our large-volume material procurement saves you time and money, independent of serial application or individual projects. The complete component ReadyChain® reduces your storage and dispatching of E-Chains®, cables and plug connectors to a minimum, and at the same time reduces the number of your suppliers and orders by 75%. Make use of the experience of over 90 igus® ReadyChain® specialists in your own interest.



More than 70,000 E-Chain® components...

Phone +49- (0) 22 03-96 49-800  
Fax +49- (0) 22 03-96 49-222



...more than 3,000 electrical components...

igus® GmbH  
51147 Cologne



...more than 850 Chainflex® special cables...

Internet: [www.igus.de](http://www.igus.de)  
E-mail: [info@igus.de](mailto:info@igus.de)



...in the huge igus® cable store.

## 2 Cut your throughput times from days to hours

The throughput time of the assembly of complete E-ChainSystems® often takes several days. Reduce the throughput times to hours - with ReadyChain® from igus®.

### ReadyChains® - Ready to fix and install

The delivery condition of your ReadyChain® is crucial for your in-house transport and installation. To bring the material into motion is one of our most important tasks for your operation. Experienced specialists from the igus® ReadyChain® project planning division would be glad to advise you in the definition of the component interfaces and on the design of the combined transport and installation aids.



Machining center - System E4/light, Chainflex® cables, mounting plates and igus® strain relief systems delivered ready to install



Racks for transport to and within your company



Large batch sizes for serial production



Installation-optimized delivery of an igus® ReadyChain®



ReadyChain® "from the roll". We supply your ReadyChain® for long travels on special cable reels



Defined picking order for your time-phased production



igus® ReadyChain® on mounting frames for lightning fast final assembly





### 3 Respond flexibly to order fluctuations

#### Utilize igus® manufacturing capacities

Transfer your capacity problems to us. The igus® ReadyChain® factory compensates for your order fluctuations with state-of-the-art production technology and specialized staff.

#### Respond flexibly and utilize our know-how

Flexible production planning Customers are guaranteed consistent quality at low costs. All employees are trained both for the ReadyChain® installation and for the cable assembly. Flexible production planning safeguards your delivery times



igus® ReadyChain®-factory: 80 experts  
produce more than 700 systems per week



Special departments take  
care of your individual project



Automatic crimp machines guarantee  
safe connections, rationally connected



The automatic cable stripping facility  
allows cheap prices for highest quality



ReadyChain® large projects - Specially trained  
employees accompany your project from start to finish



Cable handling  
and measurement



Precision at every igus® workplace.  
For batch applications and one-off projects

## 4 Minimize your machine downtimes

All components of the ReadyChain® undergo an extensive quality control and functional tests

Our quality assurance division subjects every ReadyChain® system to functional tests with special testing facilities before they are dispatched. All ReadyChain® systems and components are tested in the igus® laboratory. Over 2,000 tests are conducted with E-ChainSystems® and cables every year. With an igus® system guarantee (according to application), we offer assurance on the safety and quality of your ReadyChain®, igus® is certified according to DIN EN ISO 9001:2000



igus® climate chamber - E-Chain® and Chainflex® test runs possible at -40° to +60°C



Component test - tensile strength and shear force test of igus® E-Chain®.  $v = 10 \text{ m/s}$ ,  $a = 200 \text{ m/s}^2$



Component test - torsion tests for cables



Computer-aided, high-voltage test equipment ensure tested quality



All tests are logged and electronically stored



Test adapter for the testing of any ReadyCable®



Quality from the beginning with high-tech machines



## 5 Reduce the number of supplier and orders by 75%

One order - One invoice - One delivery - One partner

Reduce your planning costs. We relieve you of as much work as possible. Our trained staff will step by step support a smooth development of your ReadyChain® project. We can demonstrate all advantages of ReadyChain® for your business. We will visit your site discuss the application and collect all required data for your ReadyChain® project



igus® staff at the "on-site  
inspection" of a plant

Phone +49- (0) 22 03-96 49-800  
Fax +49- (0) 22 03-96 49-222

igus® GmbH  
51147 Cologne

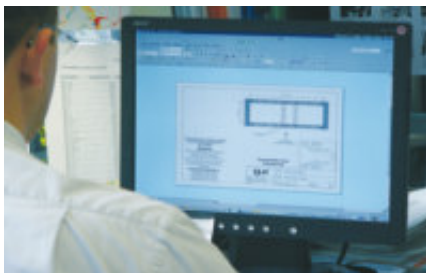

Planning with special  
software tools

Internet: [www.igus.de](http://www.igus.de)  
E-mail: [info@igus.de](mailto:info@igus.de)

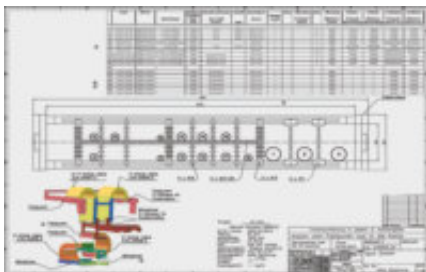

Drawing up detailed  
design worksheets

Chain, cable, assembly  
Order of components  
with ONE part number

Receipt of components

Transport to the machine  
and ready-to-use installation

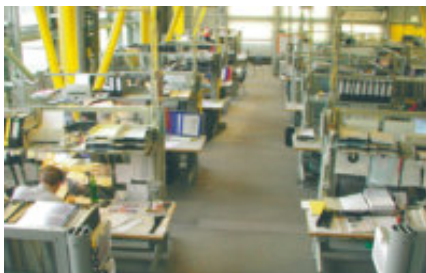

We can submit a  
complex offer within a week

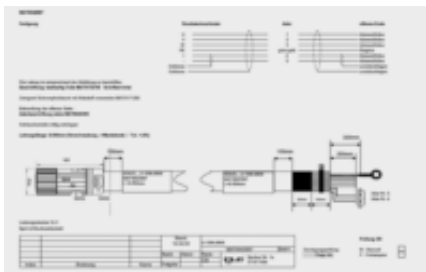

Precise job and grouping of  
cables planning for each cable





Pre-harnessed E-Tube for machining centers.  
E-Tube protect cables against dirt and chips



On-site assembly of an igus® ReadyChain®. igus® delivery scope includes machine parts, saving time and money



Horizontal machining center - harnessed with igus® E-ChainSystem® E4/4, Chainflex® cables and accessories



Machining center - System E4/light E-Chains®, Chainflex®-cables, metal parts and igus® strain relief



Flexible response to order fluctuations:  
Have the complete subassembly built at igus®



Tool magazine - igus® E2/000 E-Chain® harnessed with Chainflex® CF27, CF11 and CF.INI cables



ReadyChains®, connected through a junction box, delivered by igus®, make installation even easier



Harnessed igus® E4 E-Chains® on an X/Y unit in the textile industry with high cycle counts

ReadyChains®

Phone +49- (0) 22 03-96 49-800  
Fax +49- (0) 22 03-96 49-222



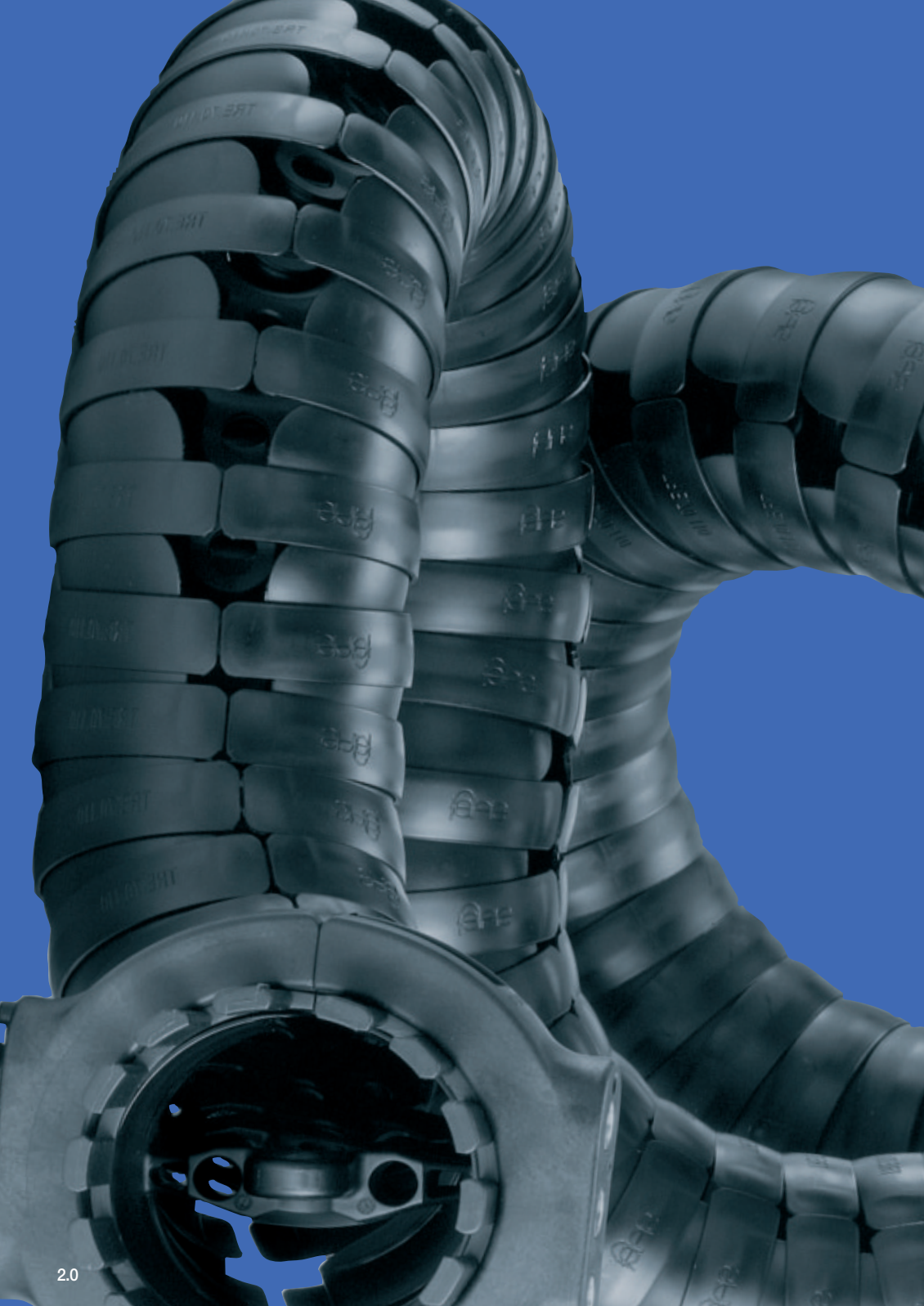

# Triflex<sup>®</sup> R Triflex<sup>®</sup> TwisterChain<sup>®</sup>







The igus® Triflex® R system is the first choice for multi-axis-robots. Three variants are available: TRC: Closed design, TRE: "Easy" design, easy to fill from outside, TRL: The "light" variant of the "Easy" design. It is universal for reliable energy supply, in general machinery with multi-axis (3D) movements

**TRC- closed design:**

- Energy supply for multi-axis 3D-movements
- High torsional stability
- Easy shortening and lengthening
- Small bend radius
- High tensile force capacity
- If a smooth and robust exterior is needed

Triflex® R TRC ► from page 2.12



**TRE- "Easy" design:**

- Cables are easy to install and replace
- Energy supply for multi-axis 3D-movements
- High torsional stability
- Easy shortening and lengthening
- Small bend radius
- High tensile force capacity

Triflex® R TRE ► from page 2.14



**TRL- light design:**

- If a light weight, cost-efficient and easy to fill 3D-E-Chain® is necessary
- If a 3D-E-Chain® for easy 3D-movements is needed
- If an easy to use 3D-E-Chain® is needed
- If a 3D-E-Chain® for nonrobotic-applications is needed

Triflex® R TRL ► from page 2.16



The Triflex® series was developed to realize safe energy supply in the case of multi-dimensional movements. In doing so the flexibility of a hose was combined with the stability of an E-Chain® and its defined radii. 2 versions are available: Easy to fill **Easy Triflex®** and the closed **Triflex®**.

#### Simple filling - Easy Triflex®:

- If easy filling and complex movements are necessary
- Very fast cable assembly with "Easy" principle
- Simple filling from two sides
- For reparations or supplements of existing Triflex®-Systems
- For simple 3D-applications

**Easy Triflex®** ► from page 2.30



#### Closed version Triflex®:

- For applications with one, two or three directions of motion (combined circle- and stroke-movements)
- Completely enclosed - protection against dirt and chips

**Triflex®** ► from page 2.42



#### Rotary motion with TwisterChain®

The TwisterChain® product line offers the biggest selection for rotary movements. TwisterChain® solutions are available with Guide Troughs:

#### TwisterChain®:

- Modular interior separation
- Crossbars can be opened on both sides
- At rotating speeds up to 90°/s
- igus® TwisterChain® for circular motions up to 540° (with special attachments)

**TwisterChain®** ► from page 2.56

Triflex<sup>®</sup> R

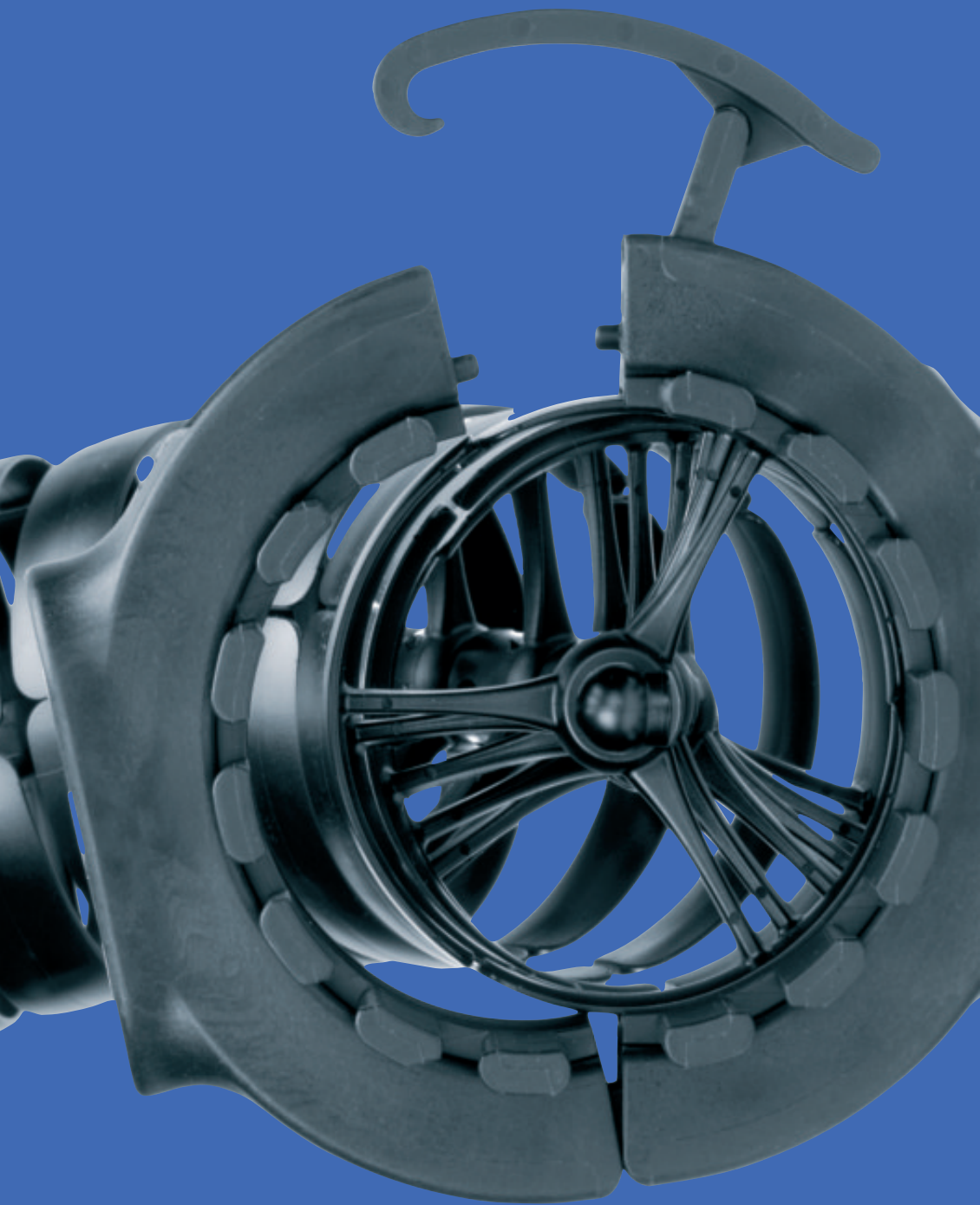

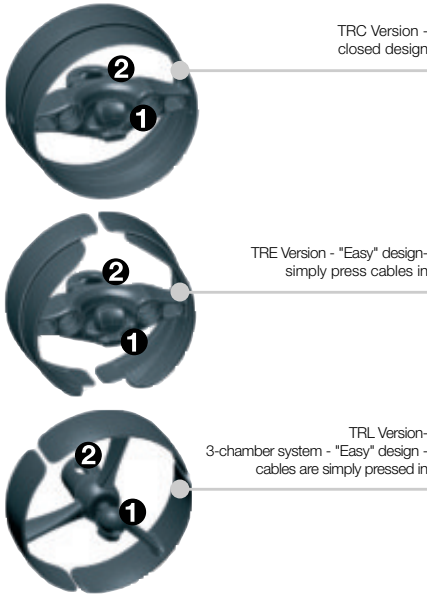

**Select this system for:**

- The first choice for multi-axis-robots
- **Three variants are available:**
  - TRC:** Closed design,
  - TRE:** "Easy" design, easy to fill from outside,
  - TRL:** The "light" variant of the "Easy" design
- Universal for general machinery
- Multi-axis (3D) movement
- High torsional stability
- Easy shortening and lengthening
- Smooth interior and exterior edges (TRC)
- Small bend radius
- 1 Ball-and-2 socket principle
- Cables easy to assemble and to replace (TRE/TRL-version)
- Triflex® R-Set - new, compact module for all movements on robots, which can be fixed on existing fastening points
- TRL - one piece, thus very lightweight
- High tensile strengths without additional elements like steel cable and spring elements etc
- You can find more technical data about the material, chemical resistance, temperatures ► **chapter design, from page 1.38**

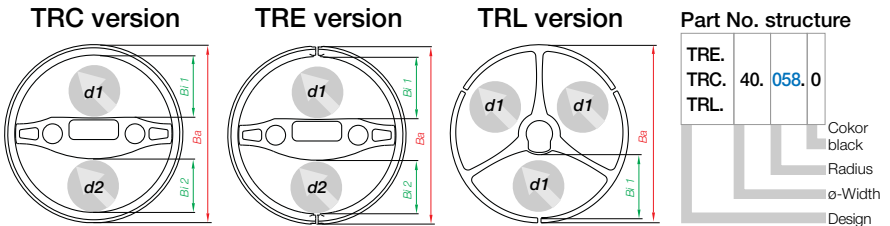

**Selection table**

Series	Inner height		max. cable ø		Outer width Ba [mm]	Bending radii R [mm]	Pitch [mm]	Links per m	Page
	Bi 1	Bi 2	d1	d2					
<b>"TRC" - Triflex® R closed design, dirt-resistant</b>									
TRC.30	12	10	10	8	34,5	50	11,3	89	2.12
TRC.40	15	13	13	11	43	58	13,9	72	2.12
TRC.60	22,5	19,5	20,5	17,5	65	87	20,4	49	2.12
TRC.70	28	24	26	22	81	110	25,6	39	2.12
TRC.85	33	28	31	26	94,5	135	30,6	33	2.12
TRC.100	37,5	32,5	35,5	30,5	108	145	34,5	29	2.12
<b>"TRE" - Triflex® R "Easy" design for fast installation of conduits</b>									
TRE.30	12	10	10*	8*	34,5	50	11,3	89	2.14
TRE.40	15	13	13*	11*	43	58	13,9	72	2.14
TRE.60	22,5	19,5	20,5*	17,5*	65	87	20,4	49	2.14
TRE.70	28	24	26*	22*	81	110	25,6	39	2.14
TRE.85	33	28	31*	26*	94,5	135	30,6	33	2.14
TRE.100	37,5	32,5	35,5*	30,5*	108	145	34,5	29	2.14
<b>"TRL" - a light and economical alternative with an "Easy" design</b>									
TRL.40	15	-	13*	-	45	58	13,9	72	2.16
TRL.60	23	-	21*	-	65	87	20,4	49	2.16
TRL.70	28	-	26*	-	81	110	25,6	39	2.16
TRL.100	37,5	-	35,5*	-	108	145	34,5	29	2.16

\*For quick and easy insertion / removal of cables using the Easy Chain® principle, we recommend a maximum cable diameter of 70% of the specified value.



Comparison of the main characteristics

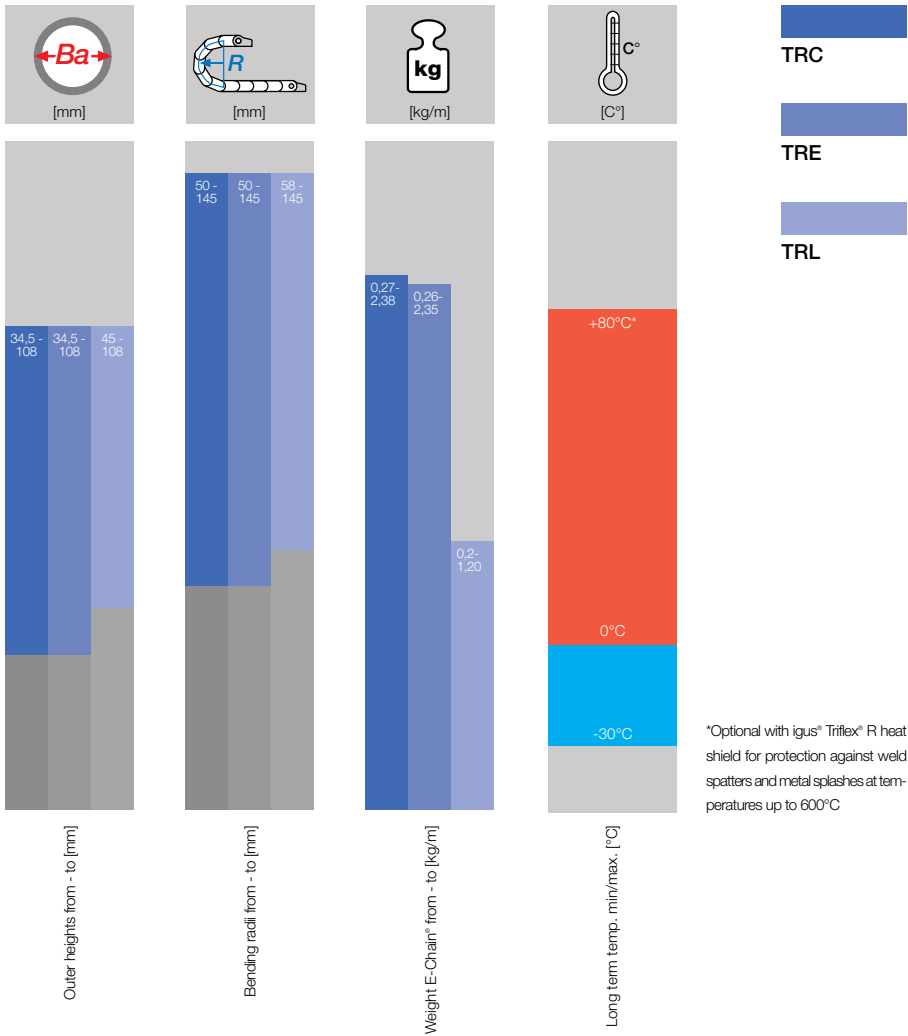

\*Optional with igus® Triflex® R heat shield for protection against weld spatters and metal splashes at temperatures up to 600°C

Additional quality features - Triflex® R

F-Design awards for TRC and TRL-design

Torsional motion possible

Cleanroom suitability upon request

# igus® System Triflex® R | Applications

Triflex® R (R for "round") is the third generation of 3-axis E-Chains® from igus®. This multi-axis energy supply system was developed specially for complex, 6-axis robotic applications in rough industrial environments. Design features include: Optional Triflex® R-Set module for complex movements, approximately  $\pm 10^\circ$  torsion per chain link, high tensile strength afforded by a ball-and-socket joint. The Triflex® R product family now comprises more than 100 components meeting all requirements ranging from those of small palletizing robots to large welding robots. Triflex® R has received the iF-Design award.

## Typical industries & applications

- The first choice for robots
- Machine tools
- Handling equipment
- Material handling
- General machinery



 iF-design award  
for Triflex® R



Triflex® R on a shredding robot at the Technical University of Darmstadt Source: "Advocut" project



igus® Triflex® R  
with Triflex® RS-System



Triflex® R with fiber rods  
and universal assembly kit



Triflex® R moulded in white  
color for pharmaceutical industry

**Assembly** | TRC.30 · TRC.40 · TRC.60 · TRC.70 · TRC.85 · TRC.100



Hold two pieces together at inner radius and move socket up against the ball's wedged end

**Separating** | TRC.30 · TRC.40 · TRC.60



Bend Triflex® R into its radius and twist apart, counter-clockwise

**Separating** | TRC.70 · TRC.85 · TRC.100



Insert screw driver into the opening of the socket from the top. Then twist apart, counter-clockwise



**Assembly** | TRE.40 · TRE.60 · TRE.70 · TRE.85 · TRE.100 (chain section exposed for the purpose of demonstration)



Hold two pieces together at inner radius and move socket up against the ball's wedged end.  
Push until a clicking sound indicates a secure fit of socket onto the ball

**Separating** | TRE.70 · TRE.85 · TRE.100

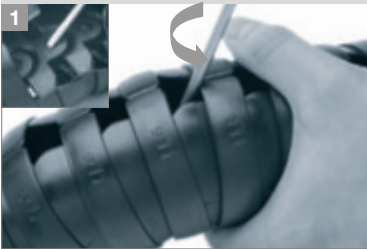

Insert screw driver into the opening of the socket from the top.  
Then twist apart, counter-clockwise

**Separating** | TRE.30 · TRE.40 · TRE.60



Bend Triflex® R into its radius and twist apart, counter-clockwise

**Filling** | TRE.30 · TRE.40 · TRE.60 · TRE.70 · TRE.85 · TRE.100



Easy to fill - simply press cables in...

...and easy to take the cables out



**Assembly** | TRL.40 · TRL.60 · TRL.70 · TRL.100



igus® Triflex® R TRL - very easy to assemble - simply press the ball into the socket, ready!

**Separating** | TRL.40 · TRL.60 · TRL.70 · TRL.100



Just twist the ball slightly to remove it from its socket

**Filling** | TRL.40 · TRL.60 · TRL.70 · TRL.100



Easy to fill - simply press cables in...

...and easy to take the cables out

**Installation** | Mounting bracket in this case, a "light" bracket with an intermediate connection



Easy assembly - to open, push a screwdriver against one side and prise apart





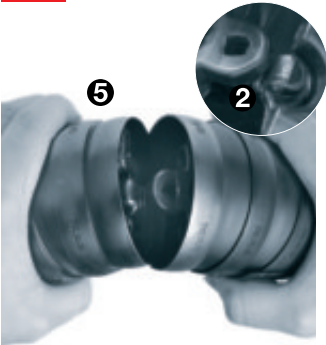

Price index

Torsional  
motion possibleCleanroom suitability  
upon requestF-Design awards  
for Triflex® R designEasiest possible assembly and dismantling  
afforded by the ball-and-socket principle

## When to use the Series TRC:

- If a secure cable guide is required for multi-dimensional (3D-) movements
- If high torsional stability is required
- If the system has to be shortened or lengthened easily
- If a small bending radius is required
- If high tensile strength is important



## When not to use it:

- For circular movements with high loads
  - ▶ **System TwisterChain®**, from page 2.56
- If simple filling is required
  - ▶ **Triflex® R - TRE**, page 2.14
- If a more simple and cost effective solution is required
  - ▶ **Triflex® R - TRL**, page 2.16



- 1 Able to move multi-dimensionally - High degree of flexibility, even on the 6th axis. Twist up to approx.  $\pm 10^\circ$  per link possible in longitudinal axis. This assists guiding the cables and lines around difficult geometries
- 2 High tensile strength thanks to special ball-and-socket principle, permits flexible movement along all axes at tested tensile forces of up to 2340 N (TRC 100.145.0)
- 3 Impact-resistant, dirt-repelling, rugged and abrasion-resistant, smooth, rounded exterior. Glides over interfering edges and protects cables by means of smooth internal and external contours. Tested over 1 million cycles at the igus® laboratory
- 4 Small bend radius & short pitch - Space-saving installation
- 5 Easy assembly and dismantling afforded by a single, die-cast component. No support elements (steel cables, spring suspensions etc.) are necessary along the tensile force vectors
- 6 High stability - Thanks to exterior stop dogs, defined stops for radius and torsion
- 7 Triflex® R-Set - New, compact module for all movements on robots, which can be fixed on existing fastening points
- 8 Easy attachment onto the robot/machine reduces setup time
- 9 For special cases furthermore available:  
Fibre rods, universal assembly kit and FlexBar

NEW!



## Order example of a complete E-Chain® - TRC.40

Indicate chain-lengths or number of links! Example: 2 m or 144 links

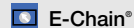
2,0 m **Series TRC.40.058.0****E-Chain®**Mounting bracket with strain relief **TR40.01****Mounting bracket**2 intermediate links without strain relief **TR40.02****Mounting bracket**+ 600 mm fiber rods **TRC.F.40.0600.1.0****Fiber rods**

Series TRC - closed design - dirt-resistant

Series	Inner height		Outer width Ba [mm]	Bending radii R [mm]	max. ø cable		Weight [kg/m]
	Bi 1	Bi 2			d1	d2	
TRC.30.	050.0	12 10	34,5	050	10	8	≈ 0,27
TRC.40.	058.0	15 13	43	058	13	11	≈ 0,37
TRC.60.	087.0	22,5 19,5	65	087	20,5	17,5	≈ 0,85
TRC.70.	110.0	28 24	81	110	26	22	≈ 1,32
TRC.85.	135.0	33 28	94,5	135	31	26	≈ 1,75
TRC.100.	145.0	37,5 32,5	108	145	35,5	30,5	≈ 2,38

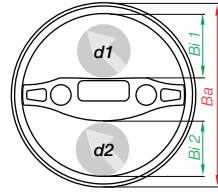

Triflex® R - TRC  
Inner height: 10-37,5 mm

0 = standard color, other colors ▶ page 1.39

Part No.	Pitch [mm]	Links/m
TRC.30.	11,3	89
TRC.40.	13,9	72
TRC.60.	20,4	49
TRC.70.	25,6	39
TRC.85.	30,6	33
TRC.100.	34,5	29

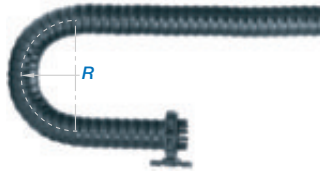

Part No. structure

TRC.	40.	058.	0
------	-----	------	---

Color  
black  
Bending  
radius  
ø-Width  
Series

Series TRC - Dimensioning

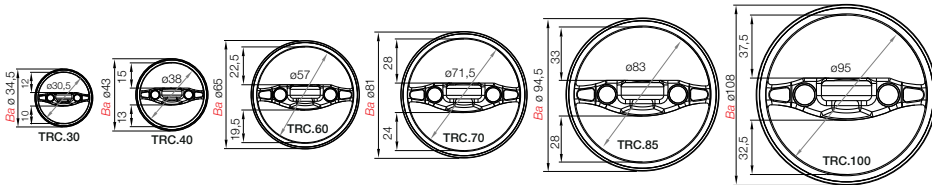

Mounting brackets and more accessories ▶ page 2.18

igus® Triflex® R-Set - **NEW!**

Universal module for any robotic motion

- One standard package for all applications for immediate installation
- Integrated spring mechanism
- The first choice for robotic applications with limited space
- Outstanding service life, universal installation ▶ from page 2.24

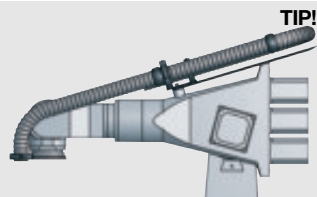

Technical Data



Details of material properties  
▶ page 1.38

Material - permitted temperature °C

igumid NB / -30° up to +80° C

Flammability class, igumid G

VDE 0304 IIC UL94 V2



▶ page 2.9

Phone +49- (0) 22 03-96 49-800  
Fax +49- (0) 22 03-96 49-222

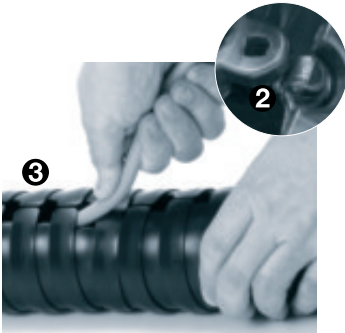

Price index

Torsional  
motion possibleCleanroom suitability  
upon requestEasy to fill - simply press cables in -  
"Easy-Principle"

## When to use the Series TRE:

- When an easy to fill 3D-E-Chain® is needed
- If a secure cable guide is required for multi-dimensional 3D-movements
- If high torsional stability is required
- If the system has to be shortened or lengthened easily
- If a small bending radius is required
- If high tensile strength is important



## When not to use it:

- For circular movements with high loads
  - ▶ **System TwisterChain®**, from page 2.56
- If a fully enclosed solution is required
  - ▶ **Triflex® R - TRC**, page 2.12
- If a more simple and cost effective solution is required
  - ▶ **Triflex® R - TRL**, page 2.16

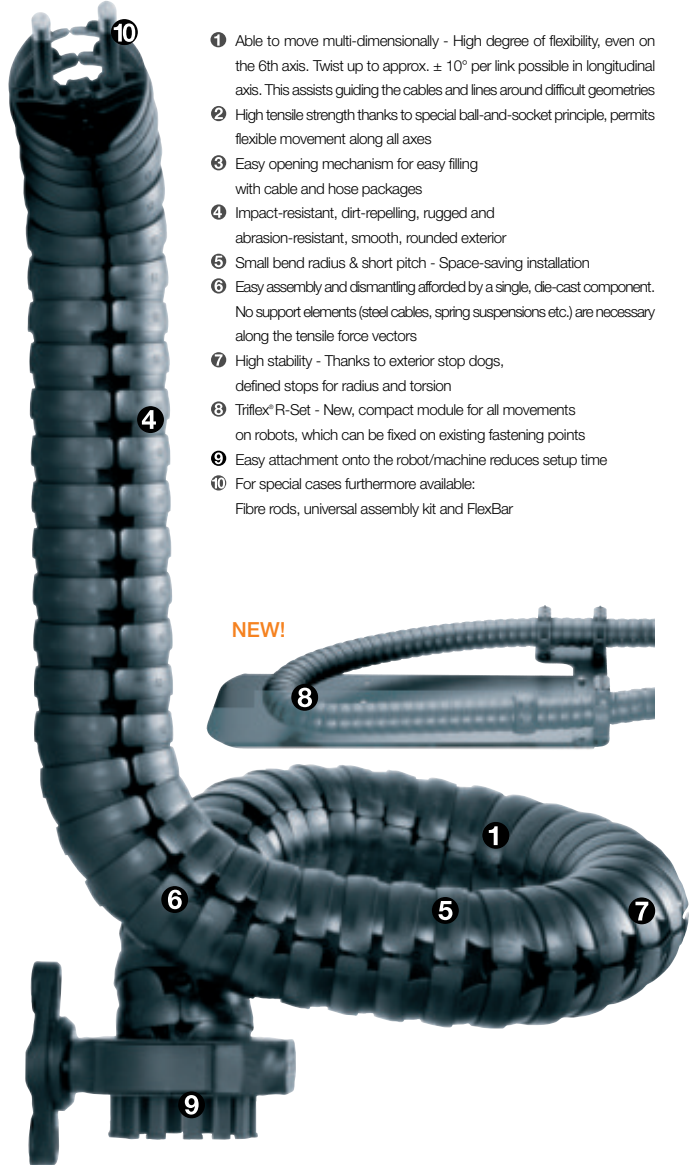

- 1 Able to move multi-dimensionally - High degree of flexibility, even on the 6th axis. Twist up to approx.  $\pm 10^\circ$  per link possible in longitudinal axis. This assists guiding the cables and lines around difficult geometries
- 2 High tensile strength thanks to special ball-and-socket principle, permits flexible movement along all axes
- 3 Easy opening mechanism for easy filling with cable and hose packages
- 4 Impact-resistant, dirt-repelling, rugged and abrasion-resistant, smooth, rounded exterior
- 5 Small bend radius & short pitch - Space-saving installation
- 6 Easy assembly and dismantling afforded by a single, die-cast component. No support elements (steel cables, spring suspensions etc.) are necessary along the tensile force vectors
- 7 High stability - Thanks to exterior stop dogs, defined stops for radius and torsion
- 8 Triflex® R-Set - New, compact module for all movements on robots, which can be fixed on existing fastening points
- 9 Easy attachment onto the robot/machine reduces setup time
- 10 For special cases furthermore available: Fiber rods, universal assembly kit and FlexBar

NEW!



## Order example of a complete E-Chain®- TRE.40

Indicate chain-lengths or number of links! Example: 2 m or 144 Links

2,0 m Serie TRE.40.058.0

E-Chain®

1 set mounting bracket with strain relief TR40.01

Mounting bracket

2 intermediate links without strain relief TR40.02

Mounting bracket

+ 600 mm fiber rods TRC.F.40.0600.1.0

Fiber rods

"TRE" - "Easy" Design - simply press cables in

Series	Inner height		Outer width		Bending radii		max. $\varnothing$ cable		Weight [kg/m]
	Bi 1	Bi 2	Ba [mm]	R [mm]	d1	d2			
TRE.30.	050.0	12 10	34,5	050	10	8		≈ 0,26	
TRE.40.	058.0	15 13	43	058	13	11		≈ 0,36	
TRE.60.	087.0	22,5 19,5	65	087	20,5	17,5		≈ 0,83	
TRE.70.	110.0	28 24	81	110	26	22		≈ 1,30	
TRE.85.	135.0	33 28	94,5	135	31	26		≈ 1,67	
TRE.100.	145.0	37,5 32,5	108	145	35,5	30,5		≈ 2,35	

\*For quick and easy insertion / removal of cables using the Easy Chain™ principle, we recommend a maximum cable diameter of 70% of the specified value.

0 = standard color, other colors ▶ page 1.39

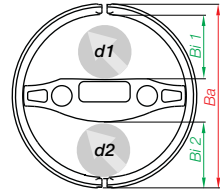

Triflex® R - TRE  
Inner height: 10-37,5 mm

Part No.	Pitch [mm]	Links/m
TRE.30.	11,3	89
TRE.40.	13,9	72
TRE.60.	20,4	49
TRE.70.	25,6	39
TRE.85.	30,6	33
TRE.100.	34,5	29

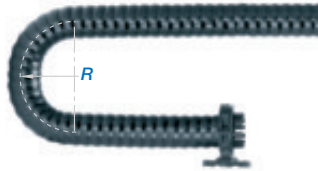

Part No. structure

TRE.	40.	058.	0
------	-----	------	---

Color  
black  
Bending radius  
 $\varnothing$ -Width  
Series

"TRE" - Dimensioning

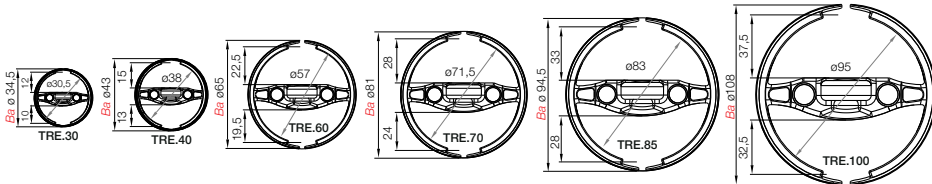

Mounting brackets and more accessories ▶ page 2.18

igus® Triflex® R-Set - **NEW!**

Universal module for any robotic motion

- One standard package for all applications for immediate installation
- Integrated spring mechanism
- The first choice for robotic applications with limited space
- Outstanding service life, universal installation ▶ from page 2.24

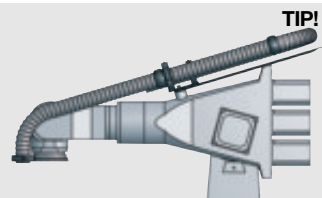

Technical Data



Details of material properties  
▶ page 1.38

Material - permitted temperature °C

igumid NB / -30° up to +80° C

Flammability class, igumid G

VDE 0304 IIC UL94 V2



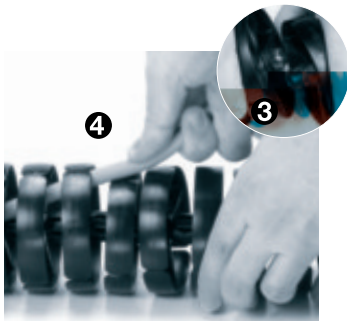

Price index

Torsional  
motion possibleCleanroom suitability  
upon requestEasy to fill - simply press cables in -  
"Easy-Principle"

When to use the Series TRL:

- When an easy to fill, economical 3D-E-Chain® is needed
- When 3D-E-Chain® for easily manageable operating conditions is needed
- When a very easily operable 3D-E-Chain® is needed



When not to use it:

- For circular movements with high loads
  - ▶ System TwisterChain®, from page 2.56
- If a fully enclosed solution is required
  - ▶ Triflex® R - TRC page 2.12
- When a rugged, easy to fill variant is needed
  - ▶ Triflex® R - TRE page 2.14

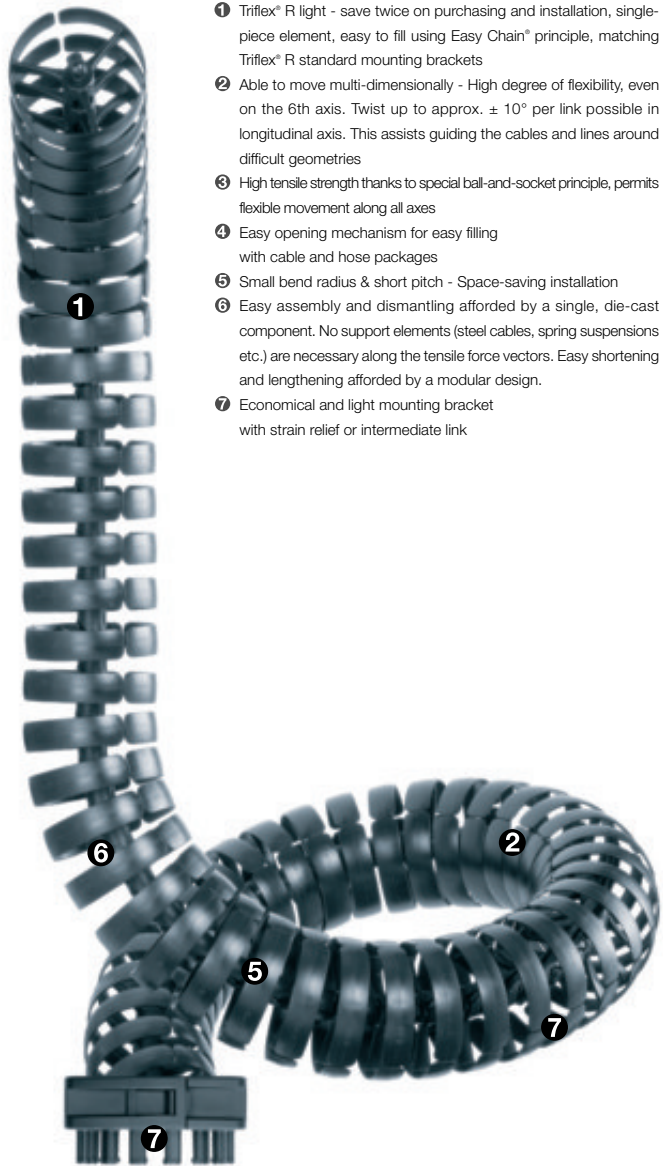

- ① Triflex® R light - save twice on purchasing and installation, single-piece element, easy to fill using Easy Chain® principle, matching Triflex® R standard mounting brackets
- ② Able to move multi-dimensionally - High degree of flexibility, even on the 6th axis. Twist up to approx.  $\pm 10^\circ$  per link possible in longitudinal axis. This assists guiding the cables and lines around difficult geometries
- ③ High tensile strength thanks to special ball-and-socket principle, permits flexible movement along all axes
- ④ Easy opening mechanism for easy filling with cable and hose packages
- ⑤ Small bend radius & short pitch - Space-saving installation
- ⑥ Easy assembly and dismantling afforded by a single, die-cast component. No support elements (steel cables, spring suspensions etc.) are necessary along the tensile force vectors. Easy shortening and lengthening afforded by a modular design.
- ⑦ Economical and light mounting bracket with strain relief or intermediate link



Order example of a complete E-Chain® - TRL.70

Indicate chain-lengths or number of links! Example: 2 m or 78 links

2,0 m Series TRL.70.110.0



E-Chain®

Mounting bracket with small strain relief TL.70.01.Z1



Mounting bracket



"TRL" - the light alternative with an "Easy" design

Series	Inner height	Outer width	Bending radii	max. $\phi$ cable	Weight
	<i>Bi 1</i>	<i>Ba</i> [mm]	<i>R</i> [mm]	<i>d1</i>	[kg/m]
TRL.40.	058.0	45	058	13	≈ 0,2
TRL.60.	087.0	65	087	20,5	≈ 0,4
TRL.70.	110.0	81	110	26	≈ 0,7
TRL.100.	145.0	108	145	35,5	≈ 1,2

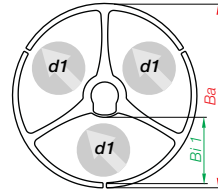

\*For quick and easy insertion / removal of cables using the Easy Chain® principle, we recommend a maximum cable diameter of 70% of the specified value.

0 = standard color, other colors ► page 1.39

Part No.	Pitch [mm]	Links/m
TRL.40.	13,9	72
TRL.60.	20,4	49
TRL.70.	25,6	39
TRL.100.	34,5	29

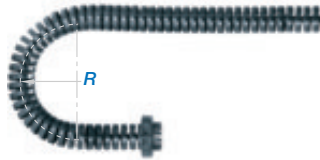

Part No. structure

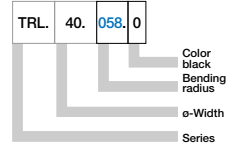

"TRL" - Dimensioning

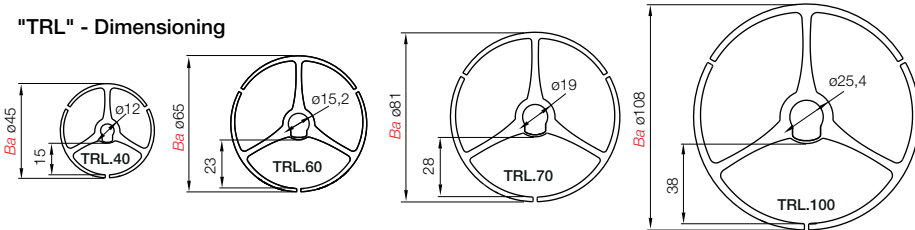

Mounting brackets and more accessories ► page 2.18

Lightweight and cost-efficient

Triflex® R light - Favorable in purchase and assembling. Cost-efficient, lightweight mounting bracket for simple 3D-movements. Mounting bracket ► page 2.19



Technical Data



Details of material properties  
► page 1.38

Material - permitted temperature °C

igumid NB / -30° up to +80° C

Flammability class, igumid G

VDE 0304 IIC UL94 V2



Triflex® R - TRL  
Inner height: 15-38 mm

Phone +49- (0) 22 03-96 49-800  
Fax +49- (0) 22 03-96 49-222



► page 2.11



**Option: Standard mounting brackets**

- Quick and easy fixing
- Short downtimes when swapping a harnessed Triflex® R system
- Mounting bracket ① with strain relief available
- Mounting bracket also as ② intermediate link and with ③ swivel bearing available ▶ page 220
- Quick assembly by means of spring locks
- Bracket holes for common robot types
- End and intermediate fixing possible

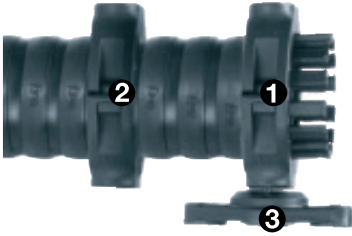

**Dimensions and order configurations**

Part No. structure

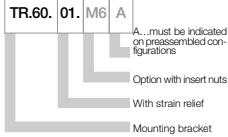

Mounting bracket with strain relief TR.XX.01

Mounting bracket as intermediate link TR.XX.02

Mounting bracket without strain relief TR.XX.02

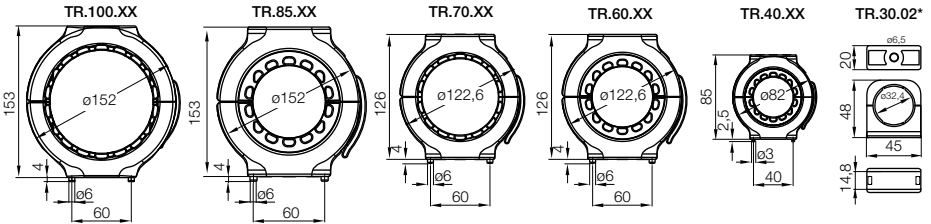
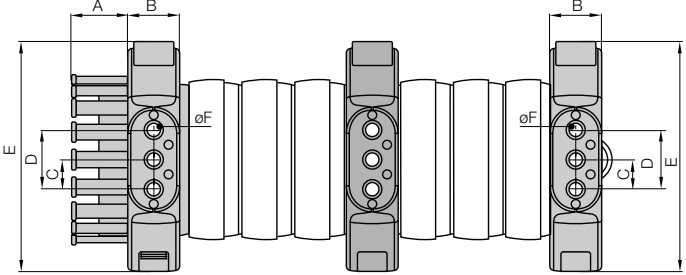

For Series	Mounting bracket with strain relief	Mounting bracket as intermediate link	Dim. A [mm]	Dim. B [mm]	Dim. C [mm]	Dim. D [mm]	Dim. E [mm]	Dim. Ø F [mm]
TRC/TRE.30.	-	TR.30.02.	*	*	*	*	*	*
TRC/TRE/TRL.40.	TR.40.01.M6	TR.40.02.M6	17,8	21	13,5	27	85	6,5
TRC/TRE/TRL.60.	TR.60.01.M8	TR.60.02.M8	25	35	20	40	126	9
TRC/TRE/TRL.70.	TR.70.01.M8	TR.70.02.M8	25	35	20	40	126	9
TRC/TRE.85.	TR.85.01.M8	TR.85.02.M8	40	35	20	40	153	9
TRC/TRE/TRL.100.	TR.100.01.M8	TR.100.02.M8	38	35	20	40	153	9

\* = dimensions in drawing

For the preassembled mode please add the index **A** Example: TR.**60**.**01** **A**

Strain relief is possible on the moving end and/or the fixed end.

Standard: Trough holes in ØF - Option: with insert nuts, steel, M6/M8

Phone +49- (0) 22 03-96 49-800  
Fax +49- (0) 22 03-96 49-222

igus® GmbH  
51147 Cologne

Internet: [www.igus.de](http://www.igus.de)  
E-mail: [info@igus.de](mailto:info@igus.de)



**Option: Light mounting brackets**

- Standard for TRL version, also compatible with all Triflex® R variants (TRC/TRE)
- Mounting bracket ① with strain relief available
- Mounting bracket also as ② intermediate link available
- Economical and light
- For simple 3D-movements and loads
- Comprising two halves - easy to assemble

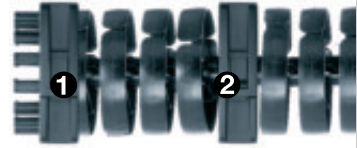

Mounting bracket with strain relief TL.XX.01.Z2

Mounting bracket as intermediate link TL.XX.01.Z0

Mounting bracket without strain relief TL.XX.01.Z0

**Dimensions and order configurations**

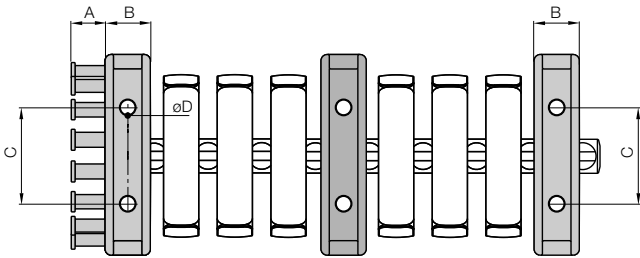

Part No. structure

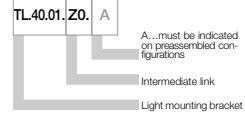

A... must be indicated on preassembled configurations  
Intermediate link  
Light mounting bracket

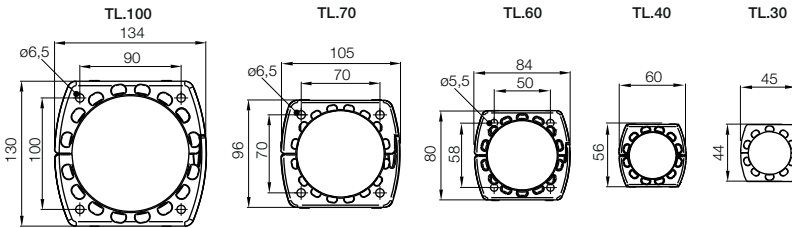

For Series	Part No.	Dim. A [mm]	Dim. B [mm]	Dim. C [mm]	Dim. ø D [mm]	For fixed end (socket)	For moving end (ball)	As intermediate link
TRC/TRE/TRL30	TL30.01.Z0	○	13	24	5,8	TRC/TRE/TRL	TRC/TRE/TRL	TRC/TRE/TRL
	TL30.01.Z1	12,5	13	24	5,8	TRC/TRE/TRL	TRL	-
	TL30.01.Z2	18	13	24	5,8	TRC/TRE/TRL	TRC/TRE/TRL	-
TRC/TRE/TRL40	TL40.01.Z0	○	14	36	5,8	TRC/TRE/TRL	TRC/TRE/TRL	TRC/TRE/TRL
	TL40.01.Z1	12,5	14	36	5,8	TRC/TRE/TRL	TRL	-
	TL40.01.Z2	20	14	36	5,8	TRC/TRE/TRL	TRC/TRE/TRL	-
TRC/TRE/TRL60	TL60.01.Z0	○	20	48	5,8	TRC/TRE/TRL	TRC/TRE/TRL	TRC/TRE/TRL
	TL60.01.Z1	17	20	48	5,8	TRC/TRE/TRL	TRL	-
	TL60.01.Z2	27	20	48	5,8	TRC/TRE/TRL	TRC/TRE/TRL	-
TRC/TRE/TRL70	TL70.01.Z0	○	27	64	6,5	TRC/TRE/TRL	TRC/TRE/TRL	TRC/TRE/TRL
	TL70.01.Z1	17,5	27	64	6,5	TRC/TRE/TRL	TRL	-
	TL70.01.Z2	27,5	27	64	6,5	TRC/TRE/TRL	TRC/TRE/TRL	-
TRC/TRE/TRL100	TL100.01.Z0	○	30	64	6,5	TRC/TRE/TRL	TRC/TRE/TRL	TRC/TRE/TRL
	TL100.01.Z1	22,5	30	64	6,5	TRC/TRE/TRL	TRL	-
	TL100.01.Z2	42,5	30	64	6,5	TRC/TRE/TRL	TRC/TRE/TRL	-

For the preassembled mode please add the index [A] Example: TR. [60].01 [A]

- = without strain relief
- = not possible

Phone +49- (0) 22 03-96 49-800  
Fax +49- (0) 22 03-96 49-222





**Option: Swivel bearing - smooth motion**

To smoothen the motion of the cables requiring guidance, it is necessary to allow for extreme twisting and bending. This relieves cables with highly sensitive bending radii (such as optical fiber cables) when following a robot's movements. Swivel bearings are used to achieve this ● Available in 2 designs (with or without strain relief) ● Pivoted bearing with a maintenance-free igubal® ball-and-socket joint ● Minimization of critical bending cycles ● Gentler motion

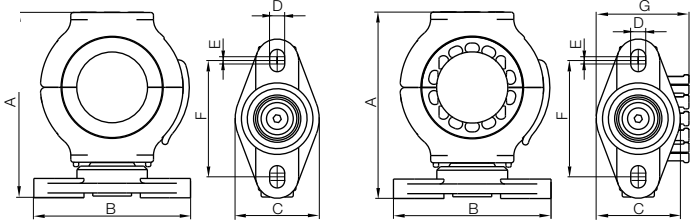

For Series	Standard	Swivel bearing with tie-wrap plate	Swivel bearing as intermediate links	Dim.	Dim.	Dim.	Dim.	Dim.	Dim.	Dim.
				A	B	C	D	E	F	G*
				[mm]	[mm]	[mm]	[mm]	[mm]	[mm]	[mm]
TRC/TRE/TRL.40.	▶	TR.40.03	TR.40.04	105	89	47	8,4	4,1	65	51,8
TRC/TRE/TRL.60.	▶	TR.60.03	TR.60.04	152	118	65	10,5	5,5	87,5	73,5
TRC/TRE/TRL.70.	▶	TR.70.03	TR.70.04	152	118	65	10,5	5,5	87,5	73,5
TRC/TRE.85.	▶	TR.85.03	TR.85.04	179	118	65	10,5	5,5	87,5	88
TRC/TRE/TRL.100.	▶	TR.100.03	TR.100.04	179	118	65	10,5	5,5	87,5	88

\*Only TR.XX.03

Triflex® R for longer service life: LSW, Bremen - TRC.100.145.0 in a hose package for handling



**Strain-relief elements (only for TRC/TRE) - large cross-sections can be fixed securely with igus® standard Chainfix clamps**

● For use with cables of large cross-sections, for example, as part of applications involving welding or heavy hydraulic hoses ● C-rails are available for TRC / TRE 70 and TRC / TRE 100 ● A holder adjustable in two dimensions is available for combination with several brands of standard jibs with a diameter of 30 mm

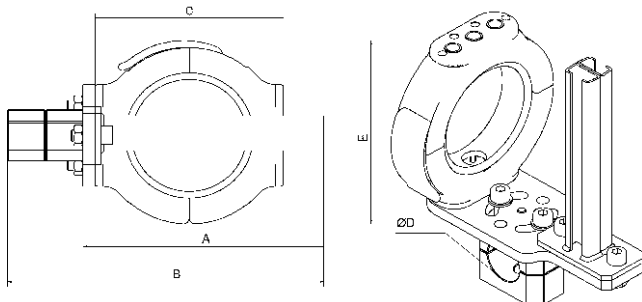

For Series	Part No. strain relief	Dim. A [mm]	Dim. B [mm]	Dim. C [mm]	Dim. Ø D [mm]	Dim. E [mm]
TRC/TRE.60	▶ TR.60.20	161	212	126	30	126
TRC/TRE.70	▶ TR.70.20	161	212	126	30	126
TRC/TRE.85	▶ TR.85.20	161	212	153	30	155
TRC/TRE.100	▶ TR.100.20	161	212	153	30	155

**Product range clamps**

Part No.	Part No.	σ [mm]	B [mm]	H [mm]	Part No.	Part No.	σ [mm]	B [mm]	H [mm]
Steel	Stainless steel*				Steel	Stainless steel*			
CFX12.1	CFX12.1.E	6 - 12	16	58	CFX26.1	CFX26.1.E	22 - 26	30	67
CFX14.1	CFX14.1.E	12 - 14	18	50	CFX30.1	CFX30.1.E	26 - 30	34	71
CFX16.1	CFX16.1.E	14 - 16	20	52	CFX34.1	CFX34.1.E	30 - 34	38	75
CFX18.1	CFX18.1.E	16 - 18	22	54	CFX38.1	CFX38.1.E	34 - 38	42	79
CFX20.1	CFX20.1.E	18 - 20	24	56	CFX42.1	CFX42.1.E	38 - 42	46	83
CFX22.1	CFX22.1.E	20 - 22	26	58					

\*Material stainless steel: 1.4301

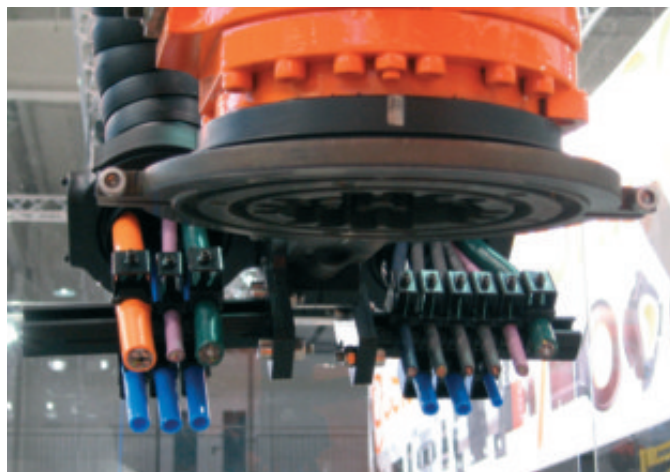
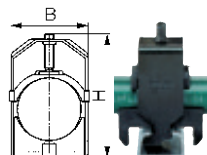

Example for a strain relief with igus® Chainfix clamps

Triflex® R

Phone +49- (0) 22 03-96 49-800  
Fax +49- (0) 22 03-96 49-222



▶ page 2.9-2.11





Triflex® RS - Extremely flat design, guides close to the robotic arm



Integrated recuperating spring prevents loop formations



Immediate installation - quick mounting on existing fastening points

### New universal module for any robotic motion

Triflex® RS is a very compact universal module that can be attached to the fastening points on the robot. Applications in very limited space can be realized, thanks to the small installation height and to the fact that Triflex® RS can be installed parallel to the robotic arm. Triflex® RS with integrated spring mechanism allows efficient energy supply to the robotic head, without stress on the cables. The new Triflex® R kit offers all advantages of proven Triflex® accessories, such as the FlexBar, universal assembly kit and fiber rod module in one system. All Triflex® R features are also included in the universal Triflex® RS module.

- **New Standard-package** for all applications for immediate installation
- **Integrated spring mechanism**
- **The first choice for robotic applications with limited space**
- **Saves space - small installation height and closely routed on the robotic arm**
- **Outstanding service life**
- **Universal installation**

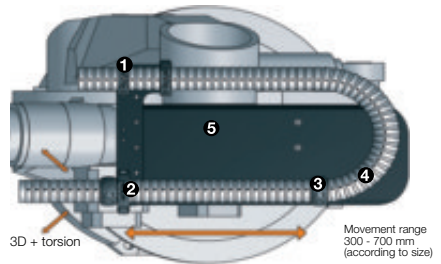

- 1 Mounting brackets for safe fastening
- 2 Glide lead-through for a close and parallel guidance on the robotic arm
- 3 Limit stop dog for a defined free movement
- 4 Integrated recuperating spring prevents loop formations
- 5 Single module, space-saving and quickly mounted on robot

### Installation Dimensions

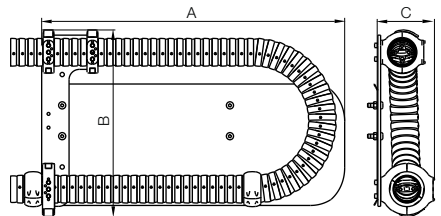

Universal module	Part No.	A	B	C
TRS for Series		[mm]	[mm]	[mm]
TRC.RC.40/TRE.RC.40	▶ TRC.RS.40	620	301	95
TRC.RC.60/TRE.RC.60	▶ TRC.RS.60	885	528	150
TRC.RC.70/TRE.RC.70	▶ TRC.RS.70	885	545	167
TRC.RC.85/TRE.RC.85	▶ TRC.RS.85	885	565	167



Other accessories available for special applications...



Fiber rod modules - smart solutions through directed pretension



Universal assembly kit fixes fiber rod modules in any position



FlexBar - for extreme robotic applications with a wide range of motions

Further information concerning this 3 products ► next page

Triflex® R

Phone +49- (0) 22 03-96 49-800  
Fax +49- (0) 22 03-96 49-222



igus® E-ChainSystems®

Phone +49- (0) 22 03-96 49-800  
Fax +49- (0) 22 03-96 49-222

igus® GmbH  
51147 Cologne

Internet: www.igus.de  
E-mail: info@igus.de

### Other accessories available for special applications...

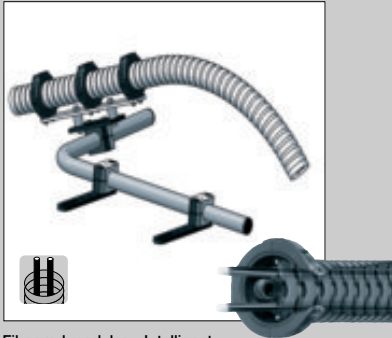

Fiber rod modules - Intelligent problem solution through directed pretension (for TRC/TRE)

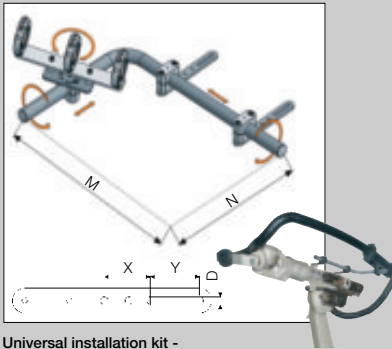

Universal installation kit - Easy engineering of the fiber rods (for TRC/TRE)

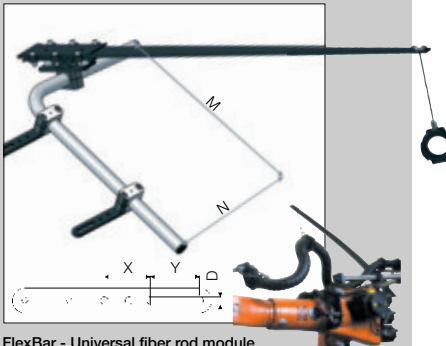

FlexBar - Universal fiber rod module for extreme robotic movements (for TRC/TRE)

The new igus® universal module as standard Triflex® R-Set ► page 2.22

### Fiber rod module, universal assembly kit and FlexBar as individual parts for Triflex® R

**Fiber rod module:** For applications where too much flexibility is not desired. **Universal installation kit:** Universal installation kit allows the attachment of fiber rod modules in any given position, relative to the robotic arm. **FlexBar:** For robot-applications with extreme movements in the 4th to 6th axis and avoidance from loops

### Product range - Fiber rods

Part No.	TRC/TRE with	Length ca. [m]	max. load [kg/m]
<b>mounted fiber rods</b>			
Triflex® R 40	TRC.F.40.1000.1.0/TRE.F.40.1000.1.0	1	0,4
	TRC.F.40.0900.1.0/TRE.F.40.0900.1.0	0,9	0,5
	TRC.F.40.0800.1.0/TRE.F.40.0800.1.0*	0,8	0,6
	TRC.F.40.0700.1.0/TRE.F.40.0700.1.0	0,7	0,7
	TRC.F.40.0600.1.0/TRE.F.40.0600.1.0	0,6	0,8
	TRC.F.40.0500.1.0/TRE.F.40.0500.1.0	0,5	0,9
Triflex® R 60	TRC.F.60.0400.1.0/TRE.F.60.0400.1.0	0,4	1
	TRC.F.60.1400.1.0/TRE.F.60.1400.1.0	1,4	1
	TRC.F.60.1200.1.0/TRE.F.60.1200.1.0	1,2	1,2
	TRC.F.60.1000.1.0/TRE.F.60.1000.1.0*	1	1,4
Triflex® R 70	TRC.F.60.0800.1.0/TRE.F.60.0800.1.0	0,8	1,6
	TRC.F.60.0600.1.0/TRE.F.60.0600.1.0	0,6	1,8
	TRC.F.60.0400.1.0/TRE.F.60.0400.1.0	0,4	2
	TRC.F.70.1800.1.0/TRE.F.70.1800.1.0	1,8	1,4
	TRC.F.70.1600.1.0/TRE.F.70.1600.1.0	1,6	1,6
	TRC.F.70.1400.1.0/TRE.F.70.1400.1.0	1,4	1,8
Triflex® R 85	TRC.F.70.1200.1.0/TRE.F.70.1200.1.0*	1,2	2
	TRC.F.70.1000.1.0/TRE.F.70.1000.1.0	1	2,2
	TRC.F.70.0800.1.0/TRE.F.70.0800.1.0	0,8	2,4
	TRC.F.85.2000.1.0/TRE.F.85.2000.1.0	2,0	1,4
	TRC.F.85.1800.1.0/TRE.F.85.1800.1.0	1,8	1,7
	TRC.F.85.1600.1.0/TRE.F.85.1600.1.0	1,6	1,9
Triflex® R 100	TRC.F.85.1400.1.0/TRE.F.85.1400.1.0	1,4	2,1
	TRC.F.85.1200.1.0/TRE.F.85.1200.1.0	1,2	2,3
	TRC.F.85.1000.1.0/TRE.F.85.1000.1.0	1,0	2,6
	TRC.F.85.0800.1.0/TRE.F.85.0800.1.0	0,8	3,0
	TRC.F.100.2000.1.0/TRE.F.100.2000.1.0	2	1,6
	TRC.F.100.1800.1.0/TRE.F.100.1800.1.0	1,8	2
Triflex® R 100	TRC.F.100.1400.1.0/TRE.F.100.1400.1.0*	1,4	2,4
	TRC.F.100.1600.1.0/TRE.F.100.1600.1.0*	1,6	2,2
	TRC.F.100.1200.1.0/TRE.F.100.1200.1.0	1,2	2,6
	TRC.F.100.1000.1.0/TRE.F.100.1000.1.0	1	3

\*recommended lengths of the fiber rods

### Product range - Universal installation kit

Installation kit for Series	Part No.	X [mm]	Y [mm]	M [mm]	N [mm]	D [mm]
TRC/TRE.40	► TR.40.80	40	30	475	325	6,3
TRC/TRE.60	► TR.60.80	40	30	475	325	6,3
TRC/TRE.70	► TR.70.80	75	80	875	575	12,5
TRC/TRE.85	► TR.85.80	75	80	875	575	12,5
TRC/TRE.100	► TR.100.80	75	80	875	575	12,5

### Product range - FlexBar

FlexBar for Series	Part No.	X [mm]	Y [mm]	M [mm]	N [mm]	D [mm]
TRC/TRE.60	► TR.60.90	40	30	475	325	6,3
TRC/TRE.70	► TR.70.90	75	80	875	575	12,5
TRC/TRE.85	► TR.85.90	75	80	875	575	12,5
TRC/TRE.100	► TR.100.90	75	80	875	575	12,5

**Triflex® R protectors - high safety under extreme operating conditions**

- To achieve long life cycles under heavy loads resulting from impact or friction on the robot's E-Chains®, optional protectors can be fitted at the contact points
- Easy assembly and quick replacement
- Abrasion-resistant TPU material
- Absorptive
- Light
- Easy gliding over edges
- Free positioning on any chain link

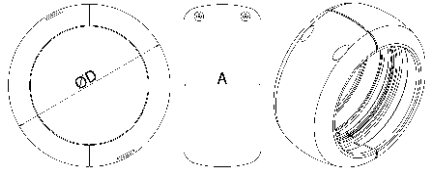

For Series	Part No. protectors	Ø D [mm]	A [mm]
TRC/TRE.40	▶ TR.40.10	53	27
TRC/TRE.60	▶ TR.60.10	77	40
TRC/TRE.70	▶ TR.70.10	100	50
TRC/TRE.85	▶ TR.85.10	118	59
TRC/TRE.100	▶ TR.100.10	133	67

**Triflex® R cover**

**TR.XX.15:** Protection against weld spatter and metal splashes at temp. of up to 600°C (short-term)

- Base support: Fabric
- Coating: Aramid
- Easy to replace via longitudinally positioned velcro fastenings
- Elastic sealing strips
- Asbest-free
- Standard lengths available ex stock

Heat shield for Series	TR.XX.15 Part No. [YY] = Jacket length	Standard lengths [mm]
TRC/TRE/TRL.40	▶ TR.40.15. [YY]	500 1000 1500 2000
TRC/TRE/TRL.60	▶ TR.60.15. [YY]	500 1000 1500 2000
TRC/TRE/TRL.70	▶ TR.70.15. [YY]	500 1000 1500 2000
TRC/TRE.85	▶ TR.85.15. [YY]	500 1000 1500 2000
TRC/TRE/TRL.100	▶ TR.100.15. [YY]	500 1000 1500 2000



**TR.XX.16:** Temperature up to room temp.

- Base support: Fabric
- Coating: None
- Easy to replace via longitudinally positioned velcro fastenings
- Elastic sealing strips
- Silicon-free
- Standard lengths available ex stock

Heat shield for Series	TR.XX.16 Part No. [YY] = Jacket length	Standard lengths [mm]
TRC/TRE/TRL.40	▶ TR.40.16. [YY]	500 1000 1500 2000
TRC/TRE/TRL.60	▶ TR.60.16. [YY]	500 1000 1500 2000
TRC/TRE/TRL.70	▶ TR.70.16. [YY]	500 1000 1500 2000
TRC/TRE.85	▶ TR.85.16. [YY]	500 1000 1500 2000
TRC/TRE/TRL.100	▶ TR.100.16. [YY]	500 1000 1500 2000

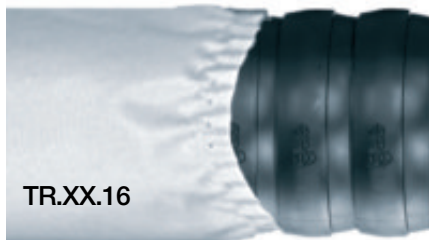

**TR.XX.17:** Temperature up to room temp.

- Base support: Fabric (spun-bonded web)
- Coating: None
- Easy to replace via longitudinally positioned velcro fastenings
- Elastic sealing strips
- Silicon-free
- Standard lengths available ex stock

Heat shield for Series	TR.XX.17 Part No. [YY] = Jacket length	Standard lengths [mm]
TRC/TRE/TRL.40	▶ TR.40.17. [YY]	500 1000 1500 2000
TRC/TRE/TRL.60	▶ TR.60.17. [YY]	500 1000 1500 2000
TRC/TRE/TRL.70	▶ TR.70.17. [YY]	500 1000 1500 2000
TRC/TRE.85	▶ TR.85.17. [YY]	500 1000 1500 2000
TRC/TRE/TRL.100	▶ TR.100.17. [YY]	500 1000 1500 2000



Triflex® R

Phone +49- (0) 22 03-96 49-800  
Fax +49- (0) 22 03-96 49-222



▶ page 2.9-2.11





Mounting bracket TR.70.01 - Strain relief for electric cables

### Choice of the right chain length

Filling and correct sizing - Clearance for cables and hoses is important when filling Triflex® R, in order to compensate for friction forces due to relative movement between E-Chain® and filling. The following serves as a rule of thumb: The total of all cable/hose diameters must not exceed 60% of the available cross section. A clearance of min. 10% (min. 1mm) needs to be maintained towards the next cable and the Triflex® R. Please see the attached chart for available cross sections. igus® will be glad to run such calculations for you.

For Series	Effective areas [mm²]
TRC.30	313
TRC.40	508
TRC.60	1144,6
TRC.70	1788
TRC.85	2431
TRC.100	3177

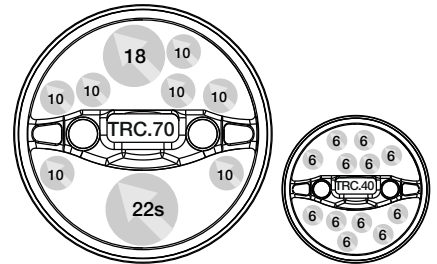

Examples of filling TRC.70 and TRC.40

No.	Name	Type	Diameter
1	primary welding wire X2.3	Cable: Welding	25 mm
2	main bus X2.4	Cable: Bus	15 mm
3	control power X2.5	Cable: Control	13 mm
4	resolver X2.6	Cable: Sensor	13 mm
5	servo power X2.7	Cable: Motor	13 mm
6	water out	Hose: Hydraulic	19 mm
7	water in	Hose: Material	19 mm
8	air main	Hose: Air	19 mm

We would be glad to help you in the selection of the right size with our Triflex® R project planning software

### Example of determining cable area

$$A_{\text{cable}} = \frac{d^2 \times \pi}{4}$$

Beispiele:

$$A_1 = \frac{(10 \text{ mm} \times 10 \text{ mm} \times \pi)}{4} = 78,5 \text{ mm}^2 \times 7 \text{ (number of cables)} = 549,50 \text{ mm}^2$$

$$A_2 = \frac{(18 \text{ mm} \times 18 \text{ mm} \times \pi)}{4} = 254,34 \text{ mm}^2$$

$$A_3 = \frac{(22 \text{ mm} \times 22 \text{ mm} \times \pi)}{4} = 379,94 \text{ mm}^2$$

$$A_{\text{cable}} = A_1 + A_2 + A_3 = 1183,7 \text{ mm}^2$$

The smaller the ratio between the effective area and the sum of the cable areas, the lower the load on the cables



### CFROBOT special cables for long life cycles in robotic applications

CFROBOT special cables for 3D applications with high torsion ratio. The CFROBOT shielded single cores are now available as the first cables of a new series of twistable Chainflex® special cables. Contrary to the conventional constructed braided copper shields, a torsionresistant, tin-plated copper shield wrap is used for the CFROBOT. The torsional movement is enabled through additional rayon fiber layers as well as a PTFE film. A high quality TPE blend with excellent abrasion characteristics is used as outer jacket material. Torsion tests in the igus® laboratory with the CFROBOT 037 type in a Triflex® R test rig against standard Chainflex® cables of the Series 310 with 270° rotation angle showed no damages (to the CFROBOT cable) even after 2.5 million cycles.



Triflex® R cable test stand with CFROBOT.037

Part No.	Conductor count + cable cross-section [mm²]	ø Outer diameter ca. [mm]	Copper index [kg/km]	Weight [kg/km]
CFROBOT.035*	(1 x 10)C	10,5	121	197
CFROBOT.036*	(1 x 16)C	11,5	183	274
CFROBOT.037*	(1 x 25)C	14,0	289	425
CFROBOT.038*	(1 x 35)C	15,5	391	534
CFROBOT.039*	(1 x 50)C	17,5	546	726

\*upon request

Triflex® R

Phone +49- (0) 22 03-96 49-800  
Fax +49- (0) 22 03-96 49-222

### Triflex® R - ReadyChain® cable packages for robots

High component holding times and low downtimes are of the highest priority in manufacturing plants. With a Triflex® R ReadyChain we design and develop a customized ReadyChain® system for you, consisting of the "construction kits" Triflex® R, Chainflex® and igus® connectors. An installation can of course be executed by our Triflex® R installation engineers on your site.

#### Your advantages:

- Reduces your storage costs to zero for cables, E-Chain® and connectors
- Cuts your running time by half
- Responds flexibly to order variations
- Minimize machine downtimes
- Reduce the number of suppliers and orders by 75%

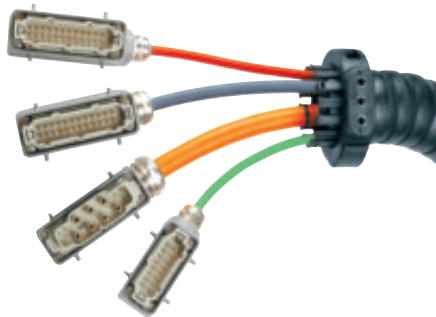

Ready-made packages in 3 to 10 days



## Higher holding times with igus® robotic cables

TIP!

Newly developed CFROBOT special cables for 3D applications with high torsion ratio. The CFROBOT shielded single cores are now available as the first cable of a new series of twistable Chainflex® special cables. Further information: [www.igus.de/en/CFROBOT](http://www.igus.de/en/CFROBOT)

IGUS® CHAINFLEX® CFROBOT.



▶ page 2.9-2.11

igus® E-ChainsSystems®

Phone +49- (0) 22 03-96 49-800  
Fax +49- (0) 22 03-96 49-222

igus® GmbH  
51147 Cologne

Internet: [www.igus.de](http://www.igus.de)  
E-mail: [info@igus.de](mailto:info@igus.de)



On-location assembly by the igus® specialist team

### We maximize your robot application's service life

Robot applications are very diverse and sometimes extremely complex in terms of configuration. To maximize your robot application's service life with Triflex® R, igus® has a specially trained, robotics planning and installation team which can install Triflex® R E-Chains® into your applications. Minimize your planning effort by delegating as many tasks as possible to us. Our trained staff offer support toward smooth project implementation every step of the way - whether you simply want to consult our assembly team or have an entire system of machines planned and installed. By telephone we can always provide answers to a host of questions and point out all the advantages of Triflex® R for your company. On site, we can acquire all the data necessary for preparing detailed planning documents. From project planning through customized quotations right up to expert installation of the Triflex® R on your site, we remain at your service round the clock.

- We also offer guarantee certificates for complete systems
- No minimum order quantities, no surcharges
- 1500 staff in Germany and at 26 international subsidiaries and offices. Stations in over 30 other countries

### Your advantage

- We are wherever you need us
- Your service requirements are fulfilled quickly by experts on location
- Guaranteed, fast worldwide delivery
- Spare parts are available from stock at short notice
- Order tracking via igus® "i-net" - [www.igus.de/en/i-net](http://www.igus.de/en/i-net)



igus® system warranty - igus® warranty certificates will be issued for your application individually. "chain, cable, warranty"

Triflex.R Packages & Prices Calculator Step I

No.	Description	Unit	Price	Weight	Length
1	1x1000m Cable	m	1000	1000	1000
2	1x1000m Cable	m	1000	1000	1000
3	1x1000m Cable	m	1000	1000	1000
4	1x1000m Cable	m	1000	1000	1000
5	1x1000m Cable	m	1000	1000	1000
6	1x1000m Cable	m	1000	1000	1000
7	1x1000m Cable	m	1000	1000	1000
8	1x1000m Cable	m	1000	1000	1000
9	1x1000m Cable	m	1000	1000	1000
10	1x1000m Cable	m	1000	1000	1000
11	1x1000m Cable	m	1000	1000	1000
12	1x1000m Cable	m	1000	1000	1000
13	1x1000m Cable	m	1000	1000	1000
14	1x1000m Cable	m	1000	1000	1000
15	1x1000m Cable	m	1000	1000	1000
16	1x1000m Cable	m	1000	1000	1000
17	1x1000m Cable	m	1000	1000	1000
18	1x1000m Cable	m	1000	1000	1000
19	1x1000m Cable	m	1000	1000	1000
20	1x1000m Cable	m	1000	1000	1000

MEiR: Please use this button to add each cable

Triflex.R Packages & Prices Calculator Step II

Package 1: Floor Rail Modules  
Package 2: Floor Rail Modules  
Package 3: Floor Rail Modules  
Package 4: Floor Rail Modules  
Package 5: Floor Rail Modules  
Package 6: Floor Rail Modules  
Package 7: Floor Rail Modules  
Package 8: Floor Rail Modules  
Package 9: Floor Rail Modules  
Package 10: Floor Rail Modules  
Package 11: Floor Rail Modules  
Package 12: Floor Rail Modules  
Package 13: Floor Rail Modules  
Package 14: Floor Rail Modules  
Package 15: Floor Rail Modules  
Package 16: Floor Rail Modules  
Package 17: Floor Rail Modules  
Package 18: Floor Rail Modules  
Package 19: Floor Rail Modules  
Package 20: Floor Rail Modules

Projection with well-designed forms and special software



if-award-winning Triflex® R TRE for a safe energy supply also in office equipment



Cable management in a TV studio with Triflex® R



igus® System E6 and Triflex® R TRE in a Y/Z-gantry



Torsion testing of Triflex® R in the igus® laboratory, Cologne



igus® E2 E-Tube and Triflex® R in a processing machine



Optimal cable guidance even under extreme conditions, such as here in the Jungmeier roof tile plant

Triflex® R

Phone +49- (0) 22 03-96 49-800  
Fax +49- (0) 22 03-96 49-222





# Easy Triflex<sup>®</sup>



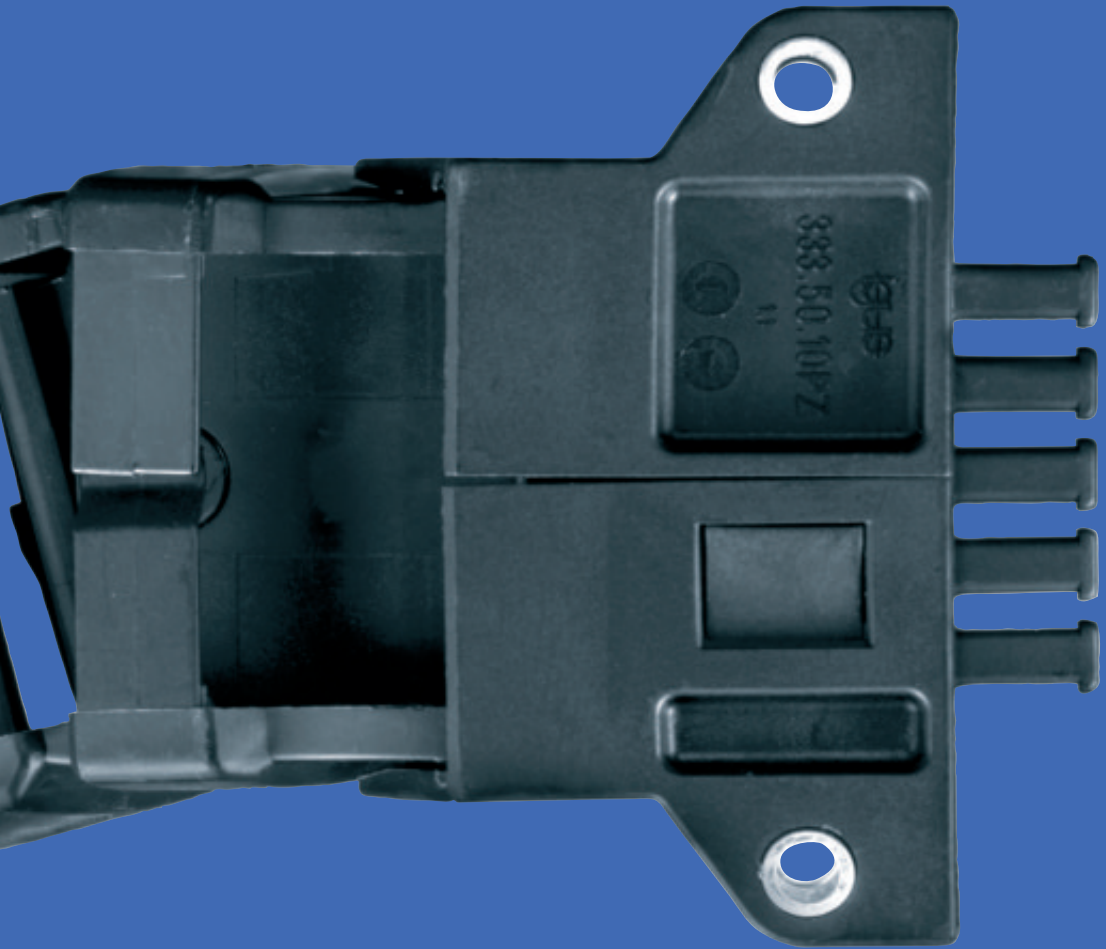



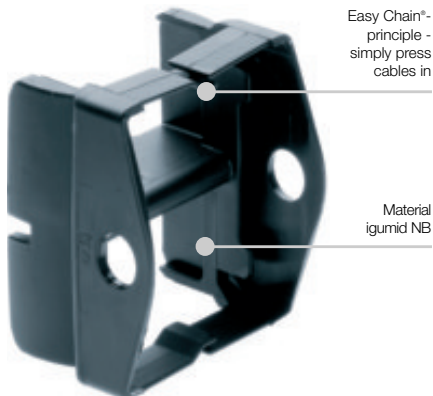

### Select this modular E-ChainSystem® for:

- 3-axis motions in all kinds of machinery
- Some robotics applications
- Very fast cable assembly with "Easy" principle
- Simple filling from two sides
- Where rectangular shapes fit better
- Combination of different bending radii and movement directions
- Lengthen and shorten anywhere
- KMA mounting brackets with integrated strain relief
- You can find more technical data about the material, chemical resistance, temperatures ► **chapter design, from page 1.38**

### Opening-principle



Easy Chain®-principle - easy to fill in outer or inner radius

### Dimensioning

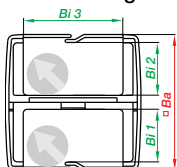

### Bending radius

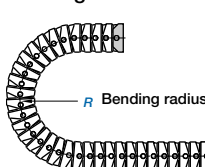

### Part No. structure

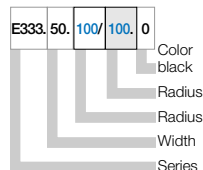

### Selection table

Series	Inner height <i>Bi 1/Bi 2</i> [mm]	Inner width <i>Bi 3</i> [mm]	Outer width/Outer height <i>Ba</i> [mm]	Bending radii <i>R</i> [mm]	Page
<b>Single-axis and double-axis movement:</b>					
E332.25	13	25	34	048 - 200	<b>2.36</b>
E332.32	17,5	37	50	075 - 250	<b>2.36</b>
E332.50	26,5	50	68	100 - 250	<b>2.36</b>
E332.75	38,5	75	96	140 - 300	<b>2.36</b>
<b>Triple-axis movement:</b>					
E333.25	13	25	34	048 - 200	<b>2.36</b>
E333.32	17,5	37	50	075 - 250	<b>2.36</b>
E333.50	26,5	50	68	100 - 250	<b>2.36</b>
E333.75	38,5	75	96	140 - 300	<b>2.36</b>

Comparison of the main characteristics

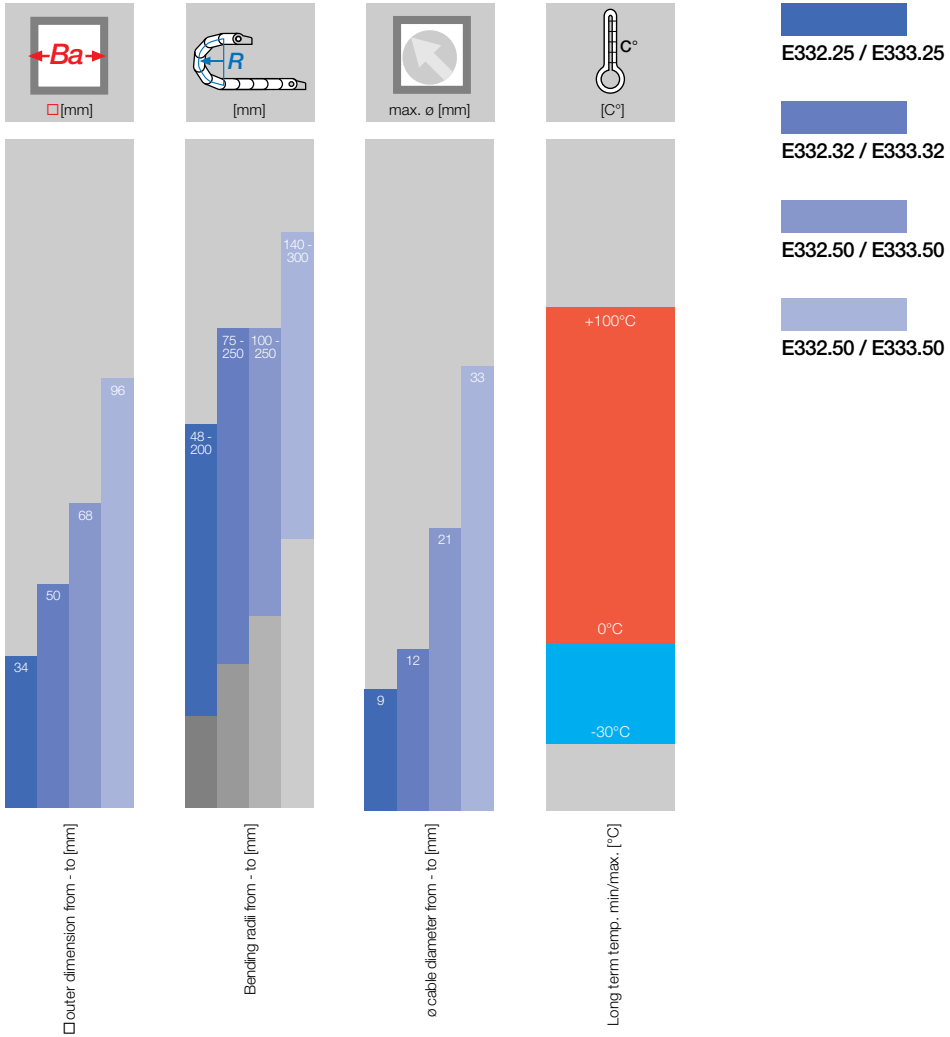

Additional quality features - Easy Triflex®

iF-Design awards for Easy Triflex® design

Torsional motion possible

UL94-V2 classifications

**Easy Triflex® - E-Chain® for 3D-motion.** The Triflex® Series was developed to realize safe energy supply in the case of **multi-dimensional movements**. In doing so the flexibility of a hose was combined with the stability of an E-Chain® and its defined radii. With the Easy Triflex® the installation of cables, wires and hoses has also become child's play. In case of flexible crossbars the cables are now simply pushed into the E-Chain® from above or below. The unique modular program allows you to follow very complex movements. For Example: Combine 1-axis, 2-axis and 3-axis movement links in one E-Chain® (see examples below)

## Typical industries & applications

- Machine tools
- Robots
- Handling equipment
- Material handling
- Plastics machinery
- Construction machines
- Vehicles
- Machinery of all kinds
- Medical equipment
- Semicon office furniture



Ford, Cologne - Robots on an assembly line with igus® Easy Triflex® E-Chains®



Easy Triflex® E-Chains® also for easy applications - here an aesthetic application



 iF-Design awards for Easy Triflex® design



Easy Triflex® E-Chains® for multi-dimensional movements on a production line

**Assembling** | Easy Triflex®



Twist and snap in



Shorten and lengthen at any given point

**Separating** | Easy Triflex®



Lever the Easy Triflex® side link with screwdriver



Twist and separate - For Series E333 you have to separate the "middle" pin

**Filling** | Easy Triflex®



Easy to fill - simply press cables in...



...and easy to take the cables out





Price index



UL94-V2 classification

Torsional  
motion possibleiF-Design awards for  
Easy Triflex® designEasy to fill - simply press cables in  
and easy to take the cables out**When to use the Series E332/E333:**

- If simple filling with complex movements is required
- If simple filling from both sides with complex movements is required
- For repair and supplementation of existing Triflex® Systems

**When not to use them:**

- If complex robotics applications are required
  - ▶ Triflex® R - TRE, from page 2.14
- For circular movements with high loads
  - ▶ System TwisterChain®, from page 2.56
- If chip protection is necessary
  - ▶ System Triflex®, from page 2.42

- 1 KMA split-open mounting bracket with integrated strain relief
- 2 Patented "push-button-principle"
- 3 Shorten and lengthen at any given point
- 4 Different bending radii and directions can be combined
- 5 Simple filling from 2 sides "Easy Chain™"-principle - simply press in cable along the inner radius or the outer radius
- 6 3-Axis motions in machinery of all kinds
- 7 Robotics applications possible
- 8 iF-Design Award Winner

**Order example of a complete E-Chain®**

Indicate chain-lengths or number of links! Example: 2 m or 68 links

2,0 m E333.50.100/100.0



E-Chain®

1 set 333.50.12PZ



Mounting bracket



**Series E332.25.2 - single/double-axis movement**

R	048	075	100	125	150	175	200
H	130	185	235	285	335	385	435
D	095	125	150	175	200	225	250
K	195	280	360	440	515	595	675

**Series E332.32.2 - single/double-axis movement**

R	075	100	125	150	200	250
H	200	250	300	350	450	550
D	130	155	180	205	255	305
K	305	385	465	545	700	865

**Series E332.50.2 - single/double-axis movement**

R	100	125	150	200	250
H	270	320	375	470	570
D	195	220	245	295	345
K	435	520	590	750	910

**Series E332.75.2 - single/double-axis movement**

R	140	175	200	250	300
H	380	450	500	600	700
D	240	275	300	350	400
K	550	660	740	900	1060

**Series E333.25 - triple-axis movement**

R	048	075	100	125	150	175	200
H	230	335	435	535	635	735	835
D	145	200	250	300	350	400	450
K	350	515	675	830	990	1150	1300

**Series E333.32 - triple-axis movement**

R	075	100	125	150	200	250
H	350	450	550	650	850	1050
D	205	255	305	355	455	555
K	545	700	860	1020	1300	1605

**Series E333.50 - triple-axis movement**

R	100	125	150	200	250
H	470	570	670	870	1070
D	295	345	395	495	595
K	750	910	1070	1380	1690

**Series E333.75 - triple-axis movement**

R	140	175	200	250	300
H	660	800	900	1100	1300
D	380	450	500	600	700
K	990	1210	1400	1700	2000

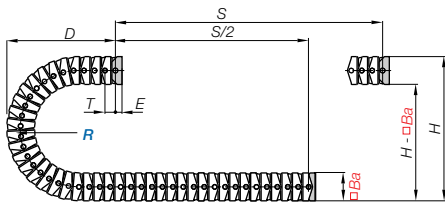

**Series E332.25.2.**

Pitch  $T = 14,5$  mm/link  
 Links/m = 69 (1000,5 mm)  
 Dim.  $E = 10$  mm  
 $Ba = 34$  mm  
 Chain length =  $S/2 + K$

**Series E332.32.2.**

Pitch  $T = 25$  mm/link  
 Links/m = 40 (1000 mm)  
 Dim.  $E = 20$  mm  
 $Ba = 50$  mm  
 Chain length =  $S/2 + K$

**Series E332.50.2.**

Pitch  $T = 30$  mm/link  
 Links/m = 34 (1020 mm)  
 Dim.  $E = 25$  mm  
 $Ba = 68$  mm  
 Chain length =  $S/2 + K$

**Series E332.75.2.**

Pitch  $T = 36$  mm/link  
 Links/m = 28 (1008 mm)  
 Dim.  $E = 25$  mm  
 $Ba = 96$  mm  
 Chain length =  $S/2 + K$

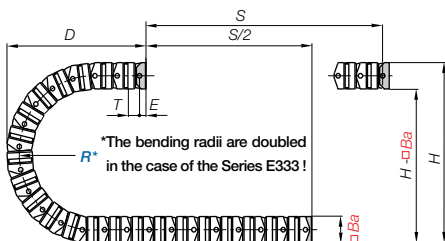

**Series E333.25.**

Pitch  $T = 14,5$  mm/link  
 Links/m = 69 (1000,5 mm)  
 Dim.  $E = 10$  mm  
 $Ba = 34$  mm  
 Chain length =  $S/2 + K$

**Series E333.32.**

Pitch  $T = 25$  mm/link  
 Links/m = 40 (1000 mm)  
 Dim.  $E = 20$  mm  
 $Ba = 50$  mm  
 Chain length =  $S/2 + K$

**Series E333.50.**

Pitch = 30 mm/link  
 Links/m = 34 (1020 mm)  
 Dim.  $E = 25$  mm  
 $Ba = 68$  mm  
 Chain length =  $S/2 + K$

**Series E333.75.**

Pitch = 36 mm/link  
 Links/m = 28 (1008 mm)  
 Dim.  $E = 25$  mm  
 $Ba = 96$  mm  
 Chain length =  $S/2 + K$

**Technical Data**



Details of material properties  
 ► page 1.38

Material - permitted temperature °C igumid NB / -30° up to +100° C  
 Flammability class, igumid G VDE 0304 IIC UL94 V2



igus® E-ChainSystems®

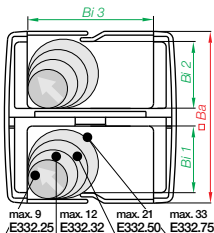

**Single-axis movement - Series E332**

Part No.	Bi 1/Bi 2 [mm]	Bi 3 [mm]	Ba [mm]	R [mm]	Bending radii	Weight [kg/m]
E332.25.2.□.0	13	25	34	048	075 100 125 150 175 200	~ 0,70
E332.32.2.□.0	17	32	50	075	100 125 150 200 250	~ 0,90
E332.50.2.□.0	26	50	68	100	125 150 200 250	~ 1,40
E332.75.2.□.0	38,5	75	96	140	175 200 250 300	~ 2,35

Supplement Part No. with required radius (R). Example: E332.50.2.□.100.0

0 = standard color, other colors ▶ page 1.39

Part No. structure

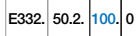

Part No.	Pitch [mm]
E332.25	14,5
E332.32	25
E332.50	30
E332.75	36

Phone +49- (0) 22 03-96 49-800  
Fax +49- (0) 22 03-96 49-222

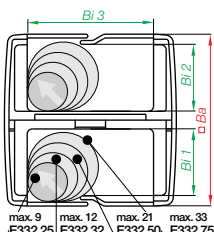

**Double-axis movement - Series E332**

Part No.	Bi 1/Bi 2 [mm]	Bi 3 [mm]	Ba [mm]	R [mm]	Bending radii	Weight [kg/m]
E332.25.2.□/□.0	13	25	34	048	075 100 125 150 175 200	~ 0,70
E332.32.2.□/□.0	17	32	50	075	100 125 150 200 250	~ 0,90
E332.50.2.□/□.0	26	50	68	100	125 150 200 250	~ 1,40
E332.75.2.□/□.0	38,5	75	96	140	175 200 250 300	~ 2,35

Supplement Part No. with required radius (R). Example: E332.75.2.□.200/200.0

0 = standard color, other colors ▶ page 1.39

\*RBR = Reversal Bending Radius

Part No. structure

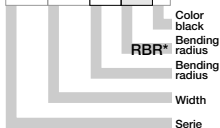
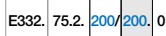

Part No.	Pitch [mm]
E332.25	14,5
E332.32	25
E332.50	30
E332.75	36

igus® GmbH  
51147 Cologne

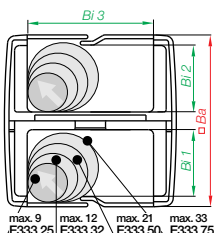

**Triple-axis movement - Series E333**

Part No.	Bi 1/Bi 2 [mm]	Bi 3 [mm]	Ba [mm]	R [mm]	Bending radii	Weight [kg/m]
E333.25.□/□/□.0	13	25	34	048	075 100 125 150 175 200	~ 0,70
E333.32.□/□/□.0	17	32	50	075	100 125 150 200 250	~ 0,90
E333.50.□/□/□.0	26	50	68	100	125 150 200 250	~ 1,40
E333.75.□/□/□.0	38,5	75	96	140	175 200 250 300	~ 2,35

The bending radii are doubled in the case of the Series E333 !

Supplement Part No. with required radius (R). Example: E333.50.□.100/100.0

0 = standard color, other colors ▶ page 1.39

\*RBR = Reversal Bending Radius

Part No. structure

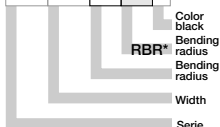

Part No.	Pitch [mm]
E333.25	14,5
E333.32	25
E333.50	30
E333.75	36

Internet: www.igus.de  
E-mail: info@igus.de



**Option KMA\* - The Standard**

- Bolted connection outside of chain cross-section
- Split-on KMA mounting bracket
- Corrosion-resistant
- Available with or without strain relief tiwrap plates
- Universal mountable with attachment capability on all sides

\*KMA = Polymer Metal Mounting Bracket

Moving end with bore  
333...1PZ(B)

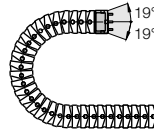

333...2PZ(B)

Fixed end with pin



These fastening variants result automatically on selection of dividable KMA mounting brackets

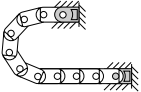

333...1PZ(B)

Moving end

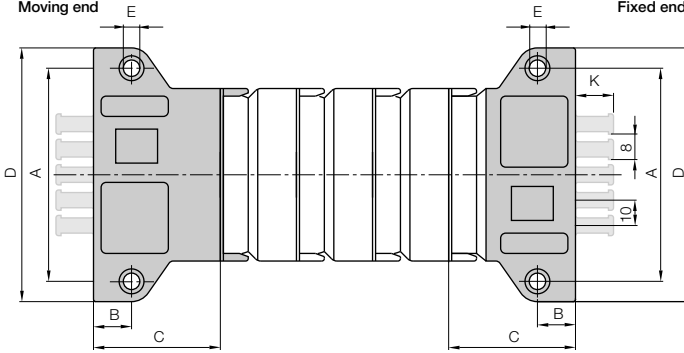

333...2PZ(B)

Fixed end

**Dimensions and order configurations**

For high loads, we recommend screwing the mounting brackets to the E-Chain\*. Contact us if you have any questions.

Part No. structure

333.32.12.PZB.A

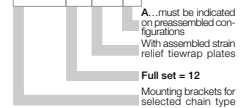

A... must be indicated on preassembled configurations  
With assembled strain relief tiwrap plates  
Full set = 12  
Mounting brackets for selected chain type

Full set, for both ends:

333.32.12.PZB + tiwrap plate

Single-part order:

333.32.1.PZB + tiwrap plate

Mounting bracket with bore

333.32.2.PZB + tiwrap plate

Mounting bracket with pin

For E-Chain*	Part No. Full set with tiwrap plate	Part No. Full set without tiwrap plate	Dim. A [mm]	Dim. B [mm]	Dim. C [mm]	Dim. D [mm]	Dim. E [mm]	Dim. K [mm]	Dim. Number of teeth
E332.25.2 / E333.25	-	333.25.12.PZ	43	7	22	52	4,5	-	-
E332.32.2 / E333.32	333.32.12.PZB	333.32.12.PZ	66	15	46	82	6,5	15	3
E332.50.2 / E333.50	333.50.12.PZB	333.50.12.PZ	84	15	50	100	6,5	15	5
E332.75.2 / E333.75	333.75.12.PZB	333.75.12.PZ	109	15	55	125	6,5	15	7

For the preassembled mode please add the index A eg. 333.25.12.PZB A

**Tiwrap plate as individual part**

**Special tiwrap plates for Easy Triflex® with KMA mounting brackets**

- Single-piece for installation inside switch cabinets or machine assembly
- Easy to assemble, no need for screws

Part No. Tiwrap plate	Width [mm]	Number of teeth	For Series
333.32.ZB	40	3	E332.32.2 / E333.32
333.50.ZB	58	5	E332.50.2 / E333.50
333.75.ZB	83	7	E332.75.2 / E333.75

Phone +49- (0) 22 03-96 49-800  
Fax +49- (0) 22 03-96 49-222





**Option steel - flange**

- One part for all chain widths
- Electrically conductive
- Flush mounting
- Galvanized steel
- Bolted connection outside of chain cross-section

Moving end with bore  
330...1

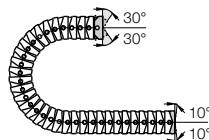

330...2

Fixed end with pin

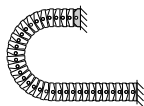

Frontal attachment option  
in the case of steel flange  
mounting brackets

**Dimensions and  
order configurations**

330...2  
Fixed end

330...1  
Moving end

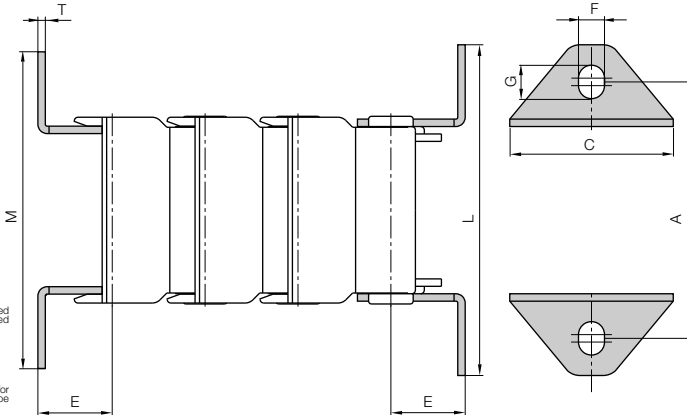

**Part No. structure**

330. 25. 12. A

A... must be indicated  
on preassembled  
configurations

Full set = 12

Width  
Mounting brackets for  
selected chain type

Full set, 4 parts

2 with pin / 2 with bore:

330. 25. 12

Single-part order:

330. 25. 1

Mounting bracket with bore

330. 25. 2

Mounting bracket with pin

For	Part No.	A	M	C	L	T	E	F	G
E-Chain®	Full set	[mm]	[mm]	[mm]	[mm]	[mm]	[mm]	[mm]	[mm]
E332.25.2 /E333.25	330.25. 12	44	55	29	55	1,5	10,5	6,5	9
E332.32.2 /E333.32	330.32. 12	66	84	44	88	2	20	7	9
E332.50.2 /E333.50	330.50. 12	84	102	62	106	2	25	7	9
E332.75.2 /E333.75	330.75. 12	109	127	90	131	2	25	7	9

For the preassembled mode please add the index **A** eg. 330.25. 12 | **A**

Phone +49- (0) 22 03-96 49-800  
Fax +49- (0) 22 03-96 49-222

igus® GmbH  
51147 Cologne

Internet: www.igus.de  
E-mail: info@igus.de



**Option steel - angle**

- One part for all chain widths
- Bolted connection outside of chain cross-section
- Electrically conductive
- Galvanized steel
- Bolted connection outside of chain cross-section possible

Moving end with bore  
338...1

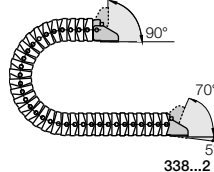

Fixed end with pin  
338...2

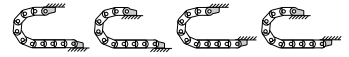

Possible installation conditions -  
Further installation angles ► installation sketch

338...2  
Fixed end

338...1  
Moving end

**Dimensions and order configurations**

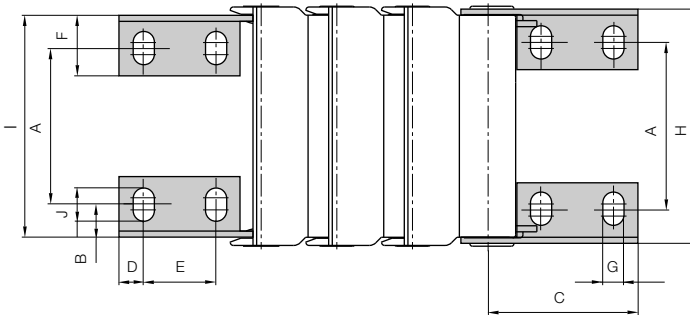

**Part No. structure**

338.	25.	12.
------	-----	-----

Full set = 12  
Width  
Mounting brackets for selected chain type

Full set, 4 parts  
2 with pin / 2 with bore:

338. 25. 12

Single-part order:

338. 25. 1

Mounting bracket with bore

338. 25. 2

Mounting bracket with pin

For	Part No.	A	B	C	D	E	F	G	H	I	J
E-Chain®	Full set	[mm]	[mm]	[mm]	[mm]	[mm]	[mm]	[mm]	[mm]	[mm]	[mm]
E332.25.2 / E333.25	► 338.25. 12	17	6,25	28	6	16	14	5,5	33,8	31	8,5
E332.32.2 / E333.32	► 338.32. 12	24	5,5	47	8	24	20	7	49	45	11
E332.50.2 / E333.50	► 338.50. 12	42	5,5	77	12	35	24	9	67	62	15
E332.75.2 / E333.75	► 338.75. 12	65	5,5	77	12	35	24	9	95	90	15

Phone +49- (0) 22 03-96 49-800  
Fax +49- (0) 22 03-96 49-222



► page 2.35



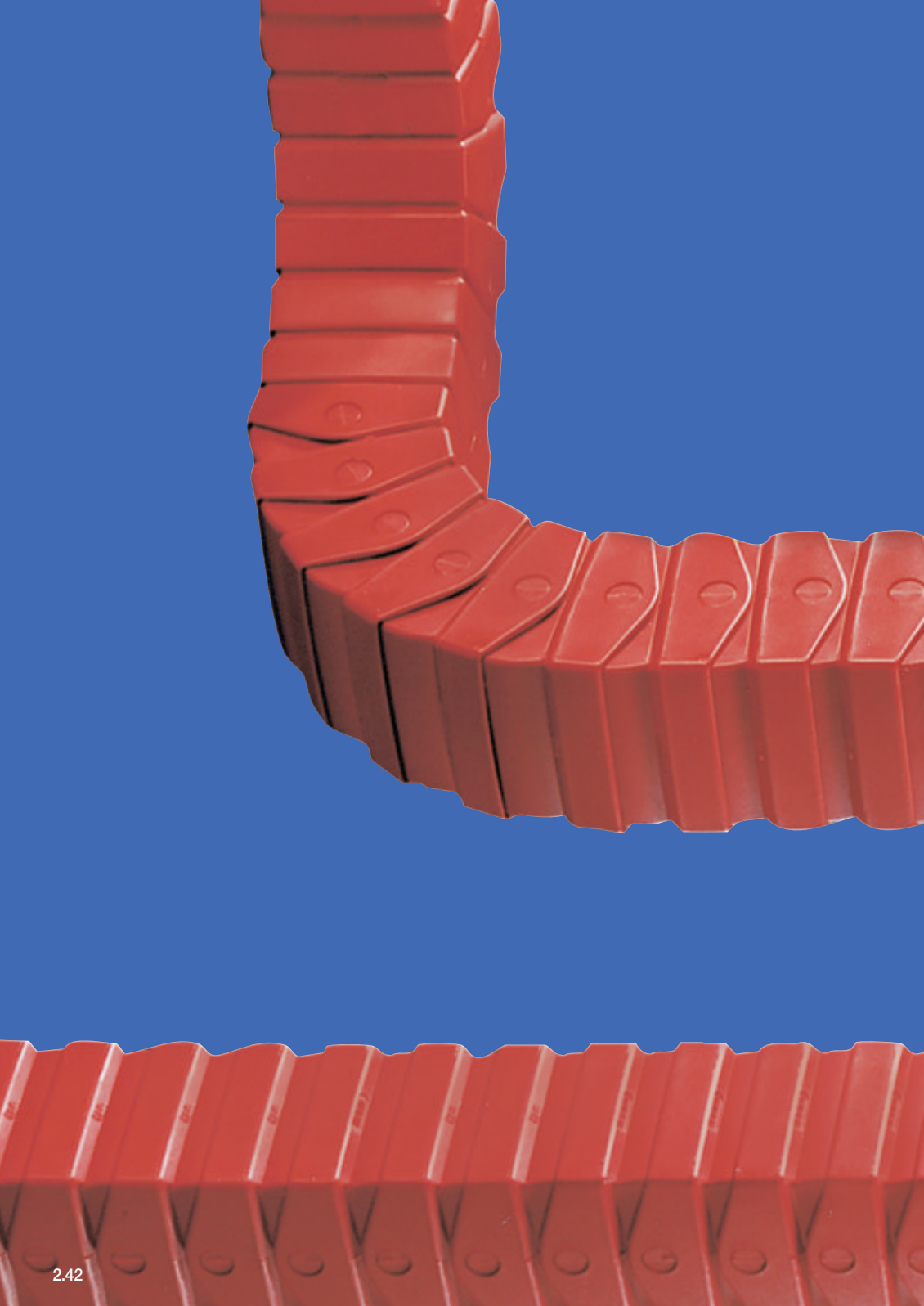

# Triflex®



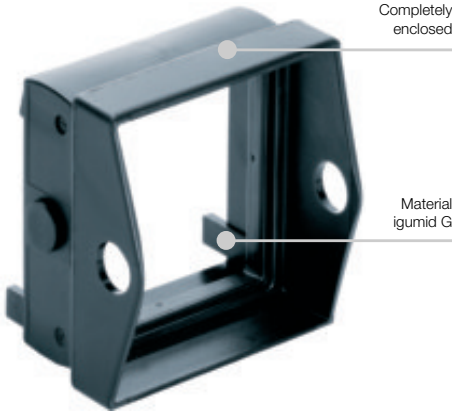

**Select this modular, robust, E-ChainSystem® for:**

- 3-axis motions in machinery of all kinds
- Dirty environments
- High tensile strength
- Where rectangular shapes fit better
- Side-mounted unsupported
- Completely enclosed - protection against dirt and chips
- Combinations of varying bending radii and moving axes
- Connecting and separating possible at every link
- Flanged mounting brackets or mounting brackets angle, galvanized steel
- Series 352 and 353 snap-open, 50 mm cross-section
- Combination Series 353/333 possible
- Cost-effective design for complex movements
- You can find more technical data about the material, chemical resistance, temperatures ► **chapter design, from page 1.38**

**Opening-principle**

- 332** Snap-open links are not necessary
- 333**
- 352** Can be opened from one side
- 353**

**Dimensioning**

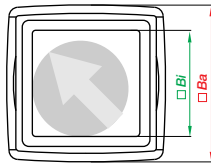

**Bending radius**

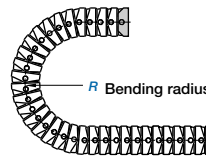

**Part No. structure**

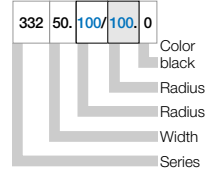

**Selection table**

Series	Inner height/Inner width □ Bi [mm]	Outer width/Outer height □ Ba [mm]	Bending radii R [mm]	Page
<b>Single-axis and double-axis movement:</b>				
332.16	16	26	038 - 100	2.48
332.32	32	50	075 - 250	2.48
332.50	50	68	100 - 250	2.48
332.75	75	96	140 - 300	2.48
<b>Triple-axis movement:</b>				
333.16	16	26	038 - 100	2.48
333.32	32	50	075 - 250	2.48
333.50	50	68	100 - 250	2.48
333.75	75	96	140 - 300	2.48
<b>Snap-open Series:</b>				
352.50	50	68	100 - 250	2.48
353.50	50	68	100 - 250	2.48

### Comparison of the main characteristics

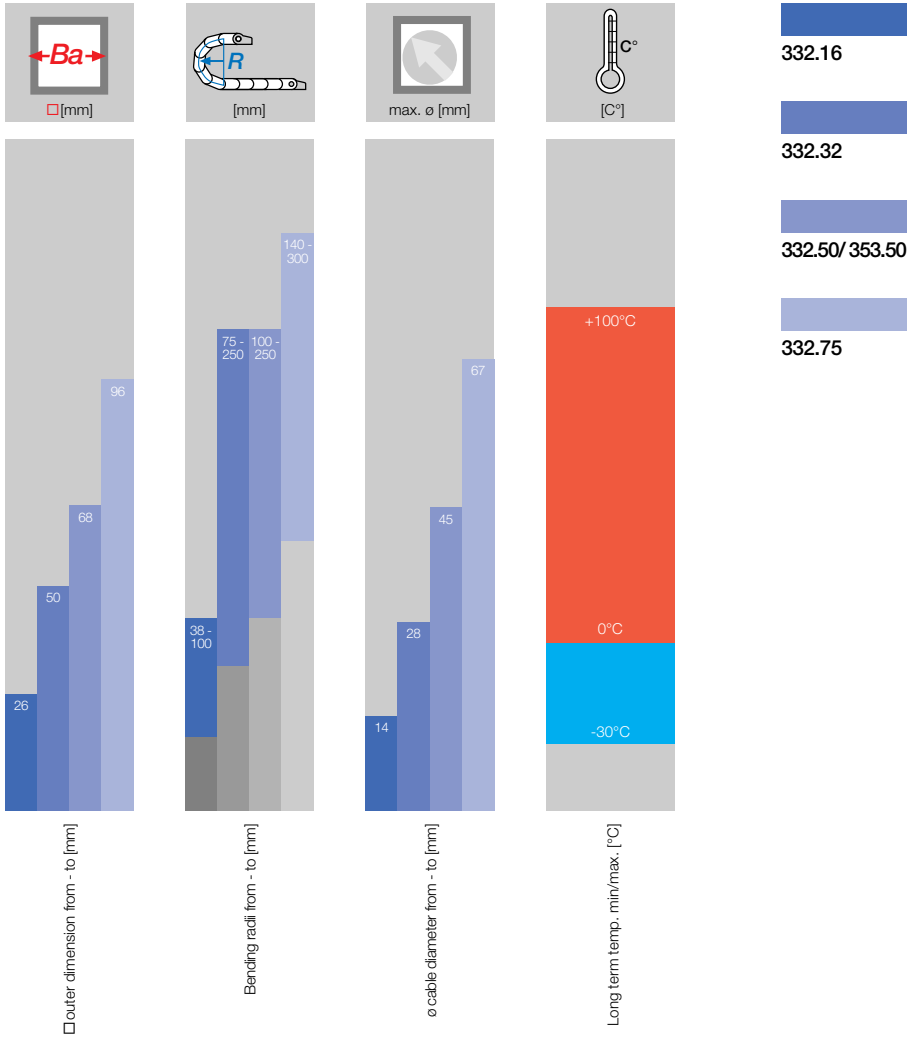

### Additional quality features- Triflex®

iF-Design awards for Triflex® design

Torsional motion possible

UL94-V2 classifications

**Triflex® - E-Chain® for 3D-motion.** The Triflex® Series was developed to realize safe energy supply in the case of **multi-dimensional movements**. In doing so the flexibility of a hose was combined with the stability of an E-Chain® and its defined radii. The unique modular program allows you to follow very complex movements. For example: Combine 1-axis, 2-axis and 3-axis movement links in one E-Chain® (see examples below).

### Typical industries & applications

- Machine tools ● Robots ● Handling equipment ● Material handling
- Plastics machinery ● Construction machines ● Vehicles ● Machinery of all kinds ● Medical equipment



Triflex® tubes: Non-openable and openable sections can be combined



Various Triflex® tubes on the inside of a machining center



Triflex® combination of locked and flexible links to a jig



Triflex® 332 as unsupported link from machines to control desk



**Assembling** | Triflex®



1 Twist and snap in



2 Snap in pin "push-button-principle"

**Separating** | Triflex®



1 Release side link



2 Twist and separate

**Filling** | Triflex® - Serien 352 und 353



1 To open Series 352 and Series 353 only - Insert screwdriver into slot on top of lid and push down



## Price index



Series 332/333    Series 352/353

UL94-V2 classifications  
upon requestTorsional  
motion possibleiF-Design awards  
for Triflex® design

Release side link, twist and separate

To open Series 352 and Series 353 only - Insert  
screwdriver into slot on top of lid and push down

## When to use the Series 332/333/352/353:

- For applications that move within two or three axes (combined rotary and circular movements)
- If chip protection is required



## When not to use them:

- For complex robotic applications
  - ▶ Triflex® R - TRC, from page 2.12
- For gliding applications, use other E-Chains®/Tubes of similar dimensions
  - ▶ System E4, chapter 7
- For rotary movements
  - ▶ System TwisterChain®, from page 2.56



- 1 KMA, flanged and angled mounting brackets available
- 2 Combinations of varying bending radii and moving axes
- 3 Completely enclosed
- 4 Protection against dirt and chips
- 5 Combination of Series 353 and Series 333 possible
- 6 Series 352 and 353 snap-open, 50mm cross-section
- 7 Cost-effective design for complex movements
- 8 Assembling and separating at any given point
- 9 High tensile strength



## Order example of a complete E-Chain®

Indicate chain-lengths or number of links! Example: 2 m or 68 links

2,0 m 332.50.100/100.0

E-Chain®

with 2 separators 351 assembled every 2<sup>nd</sup> link

Interior separation

1 set 338.50.12

Mounting bracket

**332.16 - single/double-axis movement**

R	038	048	075	100
H	105	125	180	230
D	070	080	105	130
K	200	230	315	400

**332.32 - single/double-axis movement**

R	075	100	125	150	200	250
H	200	250	300	350	450	550
D	130	155	180	205	255	305
K	305	385	465	545	700	865

**332.50/352.50 - single/double-axis movement**

R	100	125	150	200	250
H	270	320	375	470	570
D	195	220	245	295	345
K	435	520	590	750	910

**332.75 - single/double-axis movement**

R	140	175	200	250	300
H	380	450	500	600	700
D	240	275	300	350	400
K	550	660	740	900	1060

**333.16 - triple-axis movement**

R	038	048	075	100
H	180	220	330	430
D	105	125	180	230
K	320	380	550	710

**333.32 - triple-axis movement**

R	075	100	125	150	200	250
H	350	450	550	650	850	1050
D	205	255	305	355	455	555
K	545	700	860	1020	1300	1605

**333.50/353.50 - triple-axis movement**

R	100	125	150	200	250
H	470	570	670	870	1070
D	295	345	395	495	595
K	750	910	1070	1380	1690

**333.75 - triple-axis movement**

R	140	175	200	250	300
H	660	800	900	1100	1300
D	380	450	500	600	700
K	990	1210	1400	1700	2000

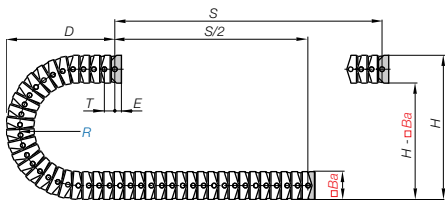

**Series 332.16**

Pitch = 13,3 mm  
 Links/m = 76 (1011 mm)  
 Dim. E = 10 mm  
 Ba = 26 mm  
 Chain length =  $S/2 + K$

**Series 332.32**

Pitch = 25 mm  
 Links/m = 40 (1000 mm)  
 Dim. E = 20 mm  
 Ba = 50 mm  
 Chain length =  $S/2 + K$

**Series 332.50/352.50**

Pitch = 30 mm  
 Links/m = 34 (1020 mm)  
 Dim. E = 25 mm  
 Ba = 68 mm  
 Chain length =  $S/2 + K$

**Series 332.75**

Pitch = 36 mm  
 Links/m = 28 (1008 mm)  
 Dim. E = 25 mm  
 Ba = 96 mm  
 Chain length =  $S/2 + K$

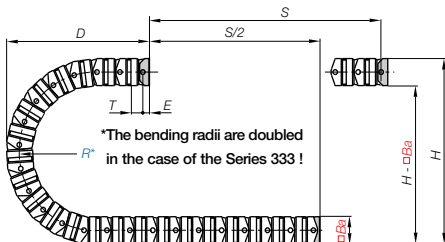

**Series 333.16**

Pitch = 13,3 mm  
 Links/m = 76 (1011 mm)  
 Dim. E = 10 mm  
 Ba = 26 mm  
 Chain length =  $S/2 + K$

**Series 333.32**

Pitch = 25 mm  
 Links/m = 40 (1000 mm)  
 Dim. E = 20 mm  
 Ba = 50 mm  
 Chain length =  $S/2 + K$

**Series 333.50/353.50**

Pitch = 30 mm  
 Links/m = 34 (1020 mm)  
 Dim. E = 25 mm  
 Ba = 68 mm  
 Chain length =  $S/2 + K$

**Series 333.75**

Pitch = 36 mm  
 Links/m = 28 (1008 mm)  
 Dim. E = 25 mm  
 Ba = 96 mm  
 Chain length =  $S/2 + K$

**Technical Data**



Details of material properties  
 ► page 1.38

Material - permitted temperature °C igumid NB / -30° up to +100 C  
 Flammability class, igumid G VDE 0304 IIC UL94 V2

Triflex®

Phone +49- (0) 22 03-96 49-800  
 Fax +49- (0) 22 03-96 49-222



► page 2.47

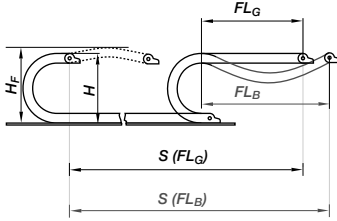

**Unsupported length**

$FL_G$  = with straight upper run

$FL_B$  = with permitted sag

Further information ► **Design**, page 1.12

$S$  = Length of travel

$H$  = Nominal clearance height

$H_F$  = Required clearance height

**Unsupported length 332.16**

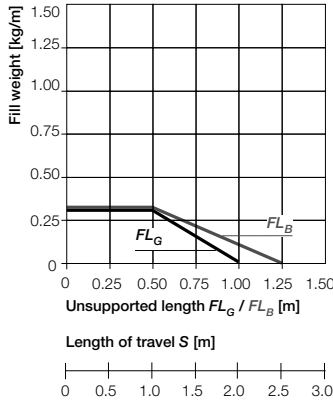

**Unsupported length 332.32**

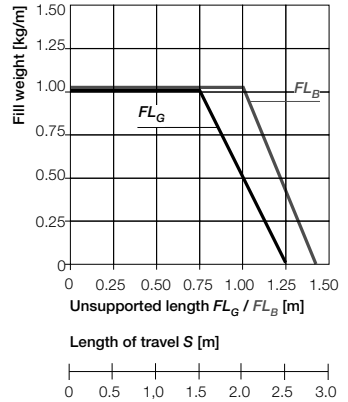

**Unsupported length 332.50/352.50**

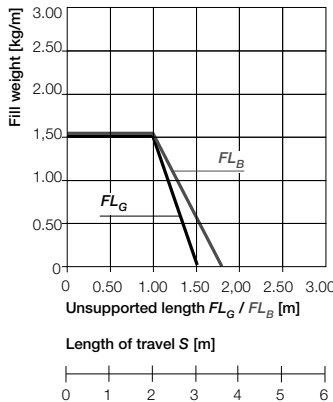

**Unsupported length 332.75**

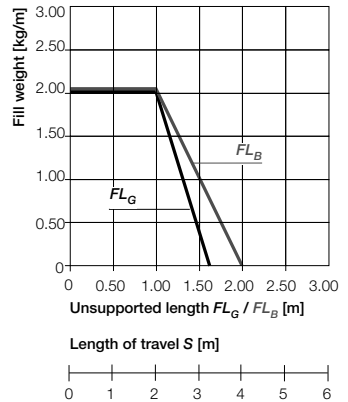

Unsupported lengths for single-axis movement only!

Single-axis movement - enclosed Series 332/snap-open Series 352

Part No.	□ Bi [mm]	□ Ba [mm]	R [mm]	Bending radii	Weight [kg/m]
332.16.□.0	16	26	038	048 075 100	≈ 0,33
332.32.□.0	32	50	075	100 125 150 200 250	≈ 0,90
332.50.□.0	50	68	100	125 150 200 250	≈ 1,40
332.75.□.0	75	96	140	175 200 250 300	≈ 2,35
Snap-open Series					
352.50.□.0	50	68	100	125 150 200 250	≈ 1,40

Supplement Part No. with required radius (R). Example: 332.50.100|0

0 = standard color, other colors ▶ page 1.39



Part No.	Pitch [mm]
332.16	13,3
332.32	25
332.50	30
332.75	36
352.50	30

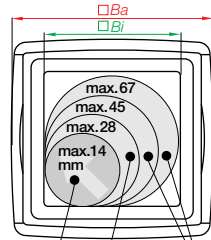

332.16|332.32|332./352.50|332.75

Part No. structure

332.	50.	100.	0
------	-----	------	---



Double-axis movement - enclosed Series 332/snap-open Series 352

Part No.	□ Bi [mm]	□ Ba [mm]	R [mm]	Bending radii	Weight [kg/m]
332.16.□/□.0	16	26	038	048 075 100	≈ 0,33
332.32.□/□.0	32	50	075	100 125 150 200 250	≈ 0,90
332.50.□/□.0	50	68	100	125 150 200 250	≈ 1,40
332.75.□/□.0	75	96	140	175 200 250 300	≈ 2,35
Snap-open Series					
352.50.□/□.0	50	68	100	125 150 200 250	≈ 1,40

Supplement Part No. with required radius (R). Example: 332.50.200|200|0

0 = standard color, other colors ▶ page 1.39

\*RBR = Reversal Bending Radius



Part No.	Pitch [mm]
332.16	13,3
332.32	25
332.50	30
332.75	36
352.50	30

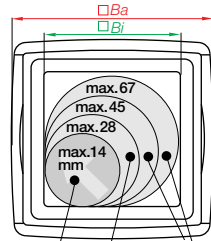

332.16|332.32|332./352.50|332.75

Part No. structure

332.	50.	200 200.	0
------	-----	----------	---



Triple-axis movement - enclosed Series 333/snap-open Series 353

Part No.	□ Bi [mm]	□ Ba [mm]	R [mm]	Bending radii	Weight [kg/m]
333.16.□/□.0	16	26	038	048 075 100	≈ 0,33
333.32.□/□.0	32	50	075	100 125 150 200 250	≈ 0,90
333.50.□/□.0	50	68	100	125 150 200 250	≈ 1,40
333.75.□/□.0	75	96	140	175 200 250 300	≈ 2,35
Snap-open Series					
353.50.□/□.0	50	68	100	125 150 200 250	≈ 1,40

Supplement Part No. with required radius (R). Example: 333.50.100|100|0

0 = standard color, other colors ▶ page 1.39

\*RBR = Reversal Bending Radius

The bending radii are doubled in the case of the Series 333!



Part No.	Pitch [mm]
333.16	13,3
333.32	25
333.50	30
333.75	36
353.50	30

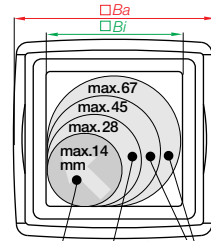

333.16|333.32|333./353.50|333.75

Part No. structure

333.	50.	100 100.	0
------	-----	----------	---



Triflex®

Phone +49- (0) 22 03-96 49-800  
Fax +49- (0) 22 03-96 49-222



▶ page 2.47



### Vertical Separators

Modular separators are available as interior separation for the igus® Triflex® System. They can be used for both vertical and horizontal sub-division. If the separators are assembled every other link and turned 90°, the tube can be sub-divided into four segments. We recommend ordering the tube preassembled, as subsequent assembly of separators is only possible after dismantling the tube. Please note that assembled separators have a different part number than unassembled separators.



Horizontal subdividing



Vertical subdividing

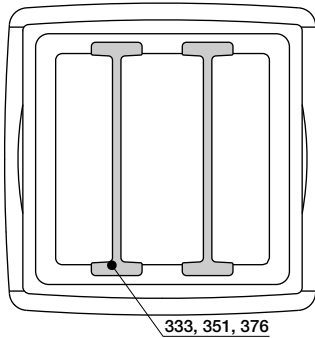

#### 332.75/333.75

Vertical Separator	
unassembled	375
assembled	376

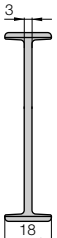
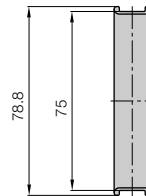

#### 332.50/333.50/352.50/353.50

Vertical Separator	
unassembled	350
assembled	351

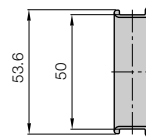

#### 332.32/333.32

Vertical Separator	
unassembled	332
assembled	333

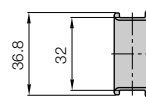



**Option KMA\* - The Standard**

- Bolted connection outside of chain cross-section possible
- Split-on KMA mounting bracket
- Corrosion-resistant
- Available with or without strain relief tiwrap plates
- Universal mountable with attachment capability on all sides

\*KMA = Polymer Metal Mounting Bracket

Moving end with bore  
333...1PZ(B)

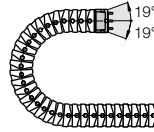

333...2PZ(B)

Fixed end with pin



These fastening variants result automatically on selection of divisible KMA mounting brackets

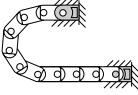

333...1PZ(B)

Moving end

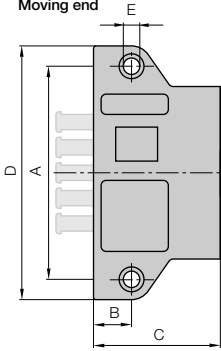

333...2PZ(B)

Fixed end

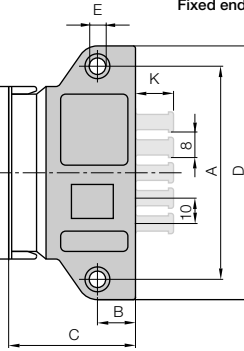

**Dimensions and order configurations**

For high loads, we recommend screwing the mounting brackets to the E-Chain\*. Contact us if you have any questions.

**Part No. structure**

333.32.12.PZB A

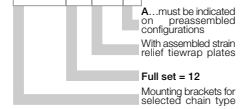

**Full set, for both ends:**

333.32.12.PZB +tiwrap plate

**Single-part order:**

333.32.1.PZB +tiwrap plate

Mounting bracket with bore

333.32.2.PZB +tiwrap plate

Mounting bracket with pin

For E-Chain*	Part No. Full set with tiwrap plate	Part No. Full set without tiwrap plate	Dim. A [mm]	Dim. B [mm]	Dim. C [mm]	Dim. D [mm]	Dim. E [mm]	Dim. K [mm]	Dim. Number of teeth
332.32 / 333.32	333.32.12.PZB	333.32.12.PZ	66	15	46	82	6,5	15	3
332.50 / 333.50	333.50.12.PZB	333.50.12.PZ	84	15	50	100	6,5	15	5
332.75 / 333.75	333.75.12.PZB	333.75.12.PZ	109	15	55	125	6,5	15	7
<b>Snap-open series</b>									
352.50 / 353.50	333.50.12.PZB	333.50.12.PZ	84	15	50	100	6,5	15	5

For the preassembled mode please add the index A eg. 333.32.12.PZB A

**Tiwrap plate as individual part**

**Special tiwrap plates for Triflex® E-Chains®**

**Application:** ● Single-piece for installation inside switch cabinets or machine assembly ● Accessory for igus® E-Chain systems\* ● Easy to assemble, no need for screws

Part No.	Width [mm]	Number of teeth	For Series
Tiwrap plate 333.32.ZB	40	3	332.32 / 333.32
333.50.ZB	58	5	332.50 / 333.50 352.50 / 353.50
333.75.ZB	83	7	332.75 / 333.75

Phone +49- (0) 22 03-96 49-800  
Fax +49- (0) 22 03-96 49-222





**Option steel - flange**

- One part for all chain widths
- Electrically conductive
- Flush mounting
- Galvanized steel
- Bolted connection outside of chain cross-section possible

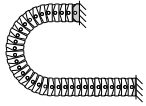

Frontal attachment option in the case of steel flange mounting brackets

Moving end with bore  
330...1

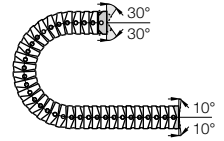

330...2

Fixed end with pin

**Dimensions and order configurations**

330...2  
Fixed end

330...1  
Moving end

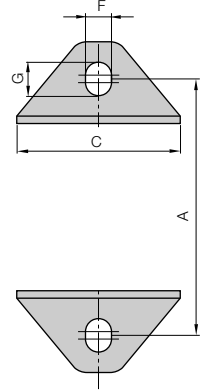
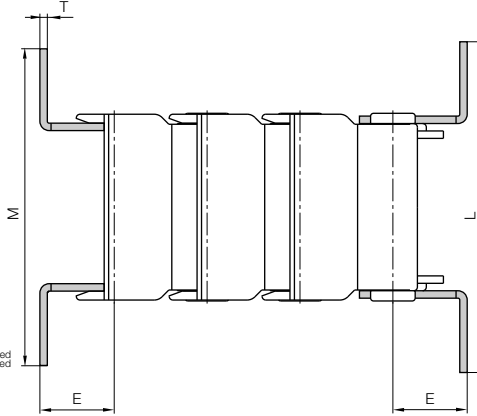

Part No. structure

330. 32. 12. A

A... must be indicated on preassembled configurations

Full set = 12

Width

Mounting brackets for selected chain type

Full set, 4 parts

2 with pin / 2 with bore:

330. 32. 12

Single-part order:

330. 32. 1

Mounting bracket with bore

330. 32. 2

Mounting bracket with pin

For	Part No.	A	M	C	L	T	E	F	G
<b>E-Chain®</b>	<b>Full set</b>	[mm]	[mm]	[mm]	[mm]	[mm]	[mm]	[mm]	[mm]
332.16 / 333.16 ▶	330.16. 12	35	53	21	57	1	10	4,5	6
332.32 / 333.32 ▶	330.32. 12	66	84	44	88	2	20	7	9
332.50 / 333.50 ▶	330.50. 12	84	102	62	106	2	25	7	9
332.75 / 333.75 ▶	330.75. 12	109	127	90	131	2	25	7	9
<b>Snap-open Series</b>									
352.50 / 353.50 ▶	330.50. 12	84	102	62	106	2	25	7	9

For the preassembled mode please add the index **A** eg. 330.32. 12 | **A**

Phone +49- (0) 22 03-96 49-800  
Fax +49- (0) 22 03-96 49-222

igus® GmbH  
51147 Cologne

Internet: www.igus.de  
E-mail: info@igus.de



**Option steel - angle**

- One part for all chain widths
- Bolted connection outside of chain cross-section possible
- Electrically conductive
- Galvanized steel
- These elements can be screwed to the floor or roof

Moving end with bore  
338...1

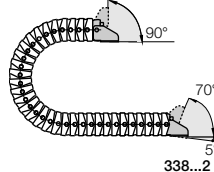

Fixed end with pin  
338...2

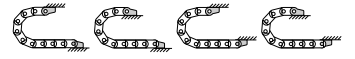

Possible installation conditions -

Further installation angles ► installation sketch

338...2  
Fixed end

338...1  
Moving end

**Dimensions and order configurations**

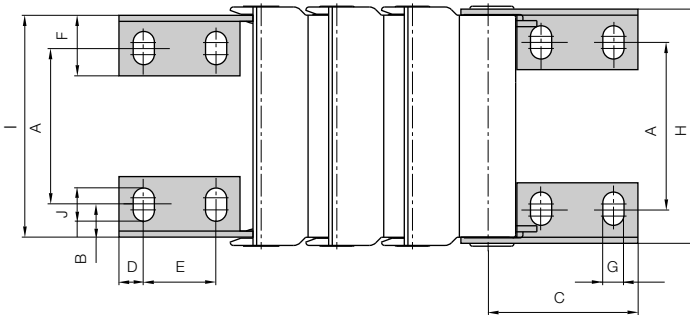

**Part No. structure**

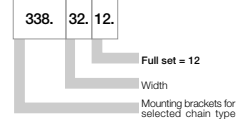

For	Part No.	A	B	C	D	E	F	G	H	I	J
E-Chain®	Full set	[mm]	[mm]	[mm]	[mm]	[mm]	[mm]	[mm]	[mm]	[mm]	[mm]
332.16 / 333.16	338.16.12	12	3	25	5	10	11	4,5	25	23	6
332.32 / 333.32	338.32.12	24	5,5	47	8	24	20	7	49	45	11
332.50 / 333.50	338.50.12	42	5,5	77	12	35	24	9	67	62	15
332.75 / 333.75	338.75.12	65	5,5	77	12	35	24	9	95	90	15
Snap-open Series											
352.50 / 353.50	338.50.12	42	5,5	77	12	35	24	9	67	62	15

**Full set, 4 parts**

2 with pin / 2 with bore:

338. 32. 12

**Single-part order:**

338. 32. 1

Mounting bracket with bore

338. 32. 2

Mounting bracket with pin

Phone +49- (0) 22 03-96 49-800  
Fax +49- (0) 22 03-96 49-222









# TwisterChain<sup>®</sup>

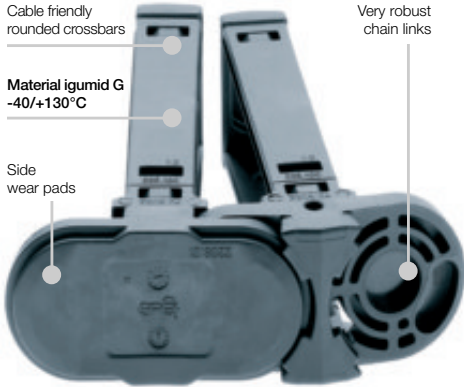

Cable friendly rounded crossbars

Material igumid G  
-40/+130°C

Side wear pads

Very robust chain links

### Select this modular "spiral" E-Chain® for:

- igus® TwisterChain® for circular motions up to 540° (with special attachments)
- Fast cable change
- Modular design - variable widths
- Cable-friendly interior
- Crossbars can be opened on both sides
- Standard guide troughs (up to 360° motion) available ex stock
- Variable interior separation
- In the case of rotational speeds of up to 4 m/s
- With steel (electrically conductive) mounting brackets
- You can find more technical data about the material, chemical resistance, temperatures ► [chapter design, from page 1.38](#)

### Opening-principle Dimensioning



Snap-open along inner and outer radius

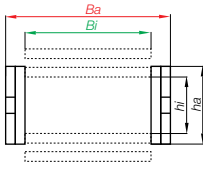

### Bending radius

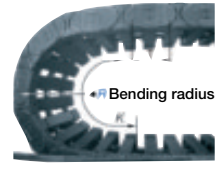

### Part No. structure

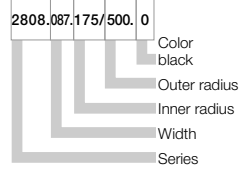

### Selection table

Series	Inner height <i>hi</i> [mm]	Inner width <i>Bi</i> [mm]	Outer width <i>Ba</i> [mm]	Outer height [mm]	Bending radii <i>R</i> [mm]	Circular radii <i>R</i> [mm]	Page
2208.	28	52,5 - 112,5	80-140	42	055 - 150	300	2.62
2808.	32	50-150	81-181	54	100 - 250	400 - 600	2.62
3808.	42	50-200	85-235	64	100 - 250	400 - 600	2.62
4008.	56	50-200	93-243	84	150 - 400	650 - 850	2.62

### Comparison of the main characteristics

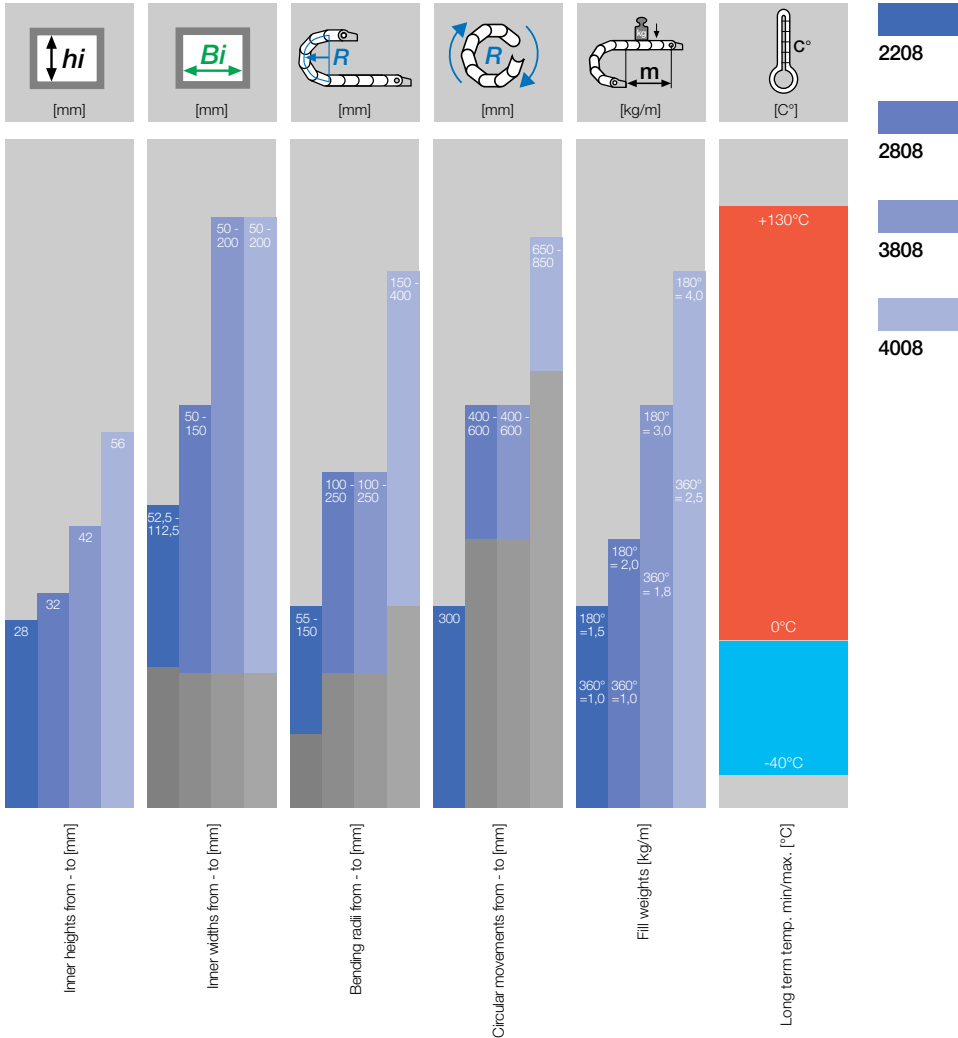

### Additional quality features - TwisterChain®



Circular movements up to 520° possible (with special attachments)



UL94-V2 classifications upon request

**Rotary motion with TwisterChain®** - The TwisterChain® product line offers the biggest selection for rotary movements. TwisterChain® solutions are particularly recommended for space-restricted applications such as articulated robots, revolving tables, etc. TwisterChain® solutions are available with Guide Troughs which affords certain advantages: ● Guidance of the chain ● Minimized wear on the chain ● Optimal running smoothness ● Rotational angle up to 540° possible (with special attachments). The modular design of the guide trough makes it possible to connect a large number of chain, circle and bending radii by using the same trough sections.

**Typical industries & applications**

- Robots
- Handling machines
- General machinery



Guide trough and bottom support. This support is required only if the support for the upper run cannot be mounted on the machine

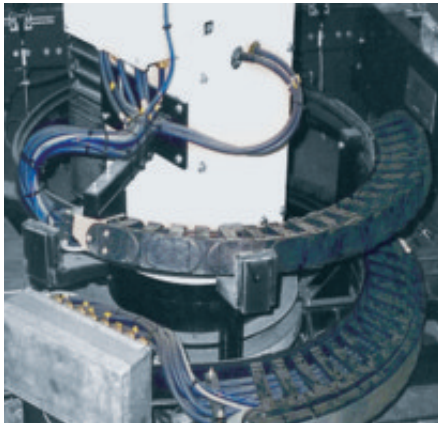

Combined spiral and rotary movement - igus® Series TwisterChain®



TwisterChain® for continuous industrial duty in 3-shift operation on a buckling arm robot (for welding applications, rotary movement 420°)



The robust link design allows also safety work in a dirty environment

**Assembly | TwisterChain®**



1 Arrangement of the guide bow on the base

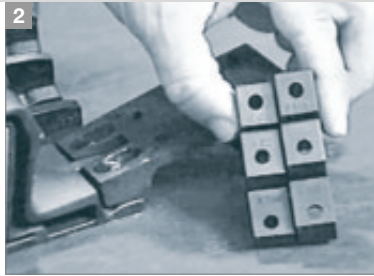

2 Screw the guide with the ground. Screw the fixed point of the TwisterChain® with the guide of the assembly plate



3 The side of the chain directed to the centre of the circular motion will be supported with both spacers. So that the lower run and the upper run of the chain are normal to each other

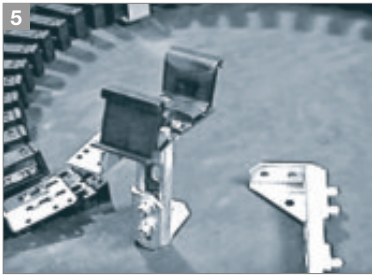
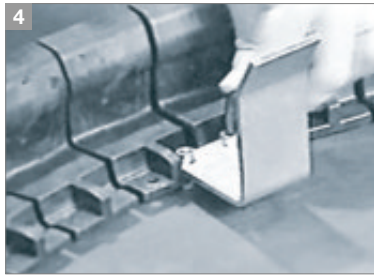

5 Screw the mounting bracket "fixed point" on the assembly plate

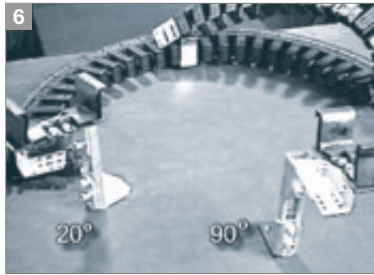

6 Installation of 1 or 2 supports for the upper run. Position and drilling template according to drawing "top view" (photo 5 + 6)

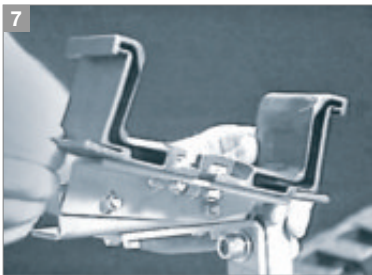

7 Adjustment of the support plate of the support at the angle of the upper run, analogy to step 3

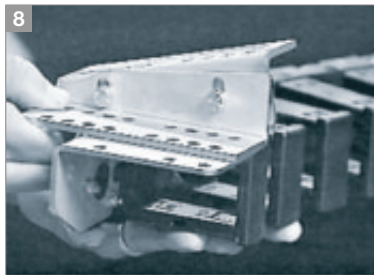

8 Adjustment of the moving end of the TwisterChain® on the machine side moving end - angle of inclination is adjustable







Price index



Circular movements  
up to 520° possible  
(with special attachments)



UL94-V2 classifications  
upon request



Opening - push a screwdriver down vertically into the opening crossbar's groove. Using the screwdriver as a lever against the horn, loosen the opening crossbar



**When to use TwisterChain®:**

- If you require variable interior separation
- If you wish conduit access on both sides
- For rotational speeds up to 90°/s
- For spiral motion up to 520° possible (with special attachments)



**When not to use it:**

- In the case of very small or very large diameters  
▶ **Design, chapter 1**
- For applications using rotation angles over 400° please consult igus®

- ① Spiral chain for rotary motion up to 540° (with special attachments)
- ② Modular design - variable widths
- ③ Dirt-repellent exterior
- ④ Crossbars which can be opened on both sides
- ⑤ Cable-friendly interior
- ⑥ Standard guide troughs available from stock
- ⑦ Interior separation possible



**Order example of a complete E-Chain®**

Indicate chain-lengths or number of links! Example: 2 m or 36 links

2,0 m 2808.087.175/500.0

E-Chain®

with 2 separators 282 assembled every 2<sup>nd</sup> link

Interior separation

1 set 28080.34

Mounting bracket



If you would like us to design your TwisterChain® application, simply supply us with your requirements. Please use the igus® System design form at the end of this chapter. If you would like to specify the chain and the guide trough yourself, please work through the following points and enter the results on the calculation sheet at the end of the chapter.

### 1. Determine the series and E-Chain® width

Specify which cables you would like to use for the E-Chain®. The type of cables and the largest cable diameter determine the Series and E-Chain® width selection. We recommend that you allow for a cable clearance of approx 20% of the chain's internal height and width. For instance, you must choose Series 3808 for a cable diameter of 30 mm.

### 2. Specify the outer and inner radius

Determine the construction space available to you (dim.  $X_1$  and  $X_2$ )

**Example:**  $\alpha = 220^\circ$  / max. cable diameter 24 mm  $\rightarrow$  **Serie 2808**

$X_2 = 580$  mm  $\rightarrow$   $AR = 500$  mm       $X_1 = 310$  mm  $\rightarrow$   $IR_{min} = 390$  mm  $\rightarrow$  selection table  $\rightarrow$  392 mm

### 3. Specify the bending radius R

$H_F = 460$  mm  $\rightarrow H \leq 410$  mm  $\rightarrow R = \frac{H - ha}{2} = 178$  mm  $\rightarrow$  **R175\*** ▶ **Results: Part No. 2808.087.175/500**  
\*next smallest radius

### 4. Calculate the required number of links

$$\text{Number of links: } n = \frac{\pi \times AR \times \alpha}{360^\circ \times T} + \frac{K}{T}$$

● The resulting number of links must always be rounded up! ● The mounting brackets may be attached only to the outside plates of the TwisterChain®. Consequently, the number of links must always **be rounded up to the next higher odd number!**

- a** = Acceleration
- $\alpha$  = Rotation angle
- AR** = Outer radius, E-Chain®
- Ba** = Outer E-Chain® width
- Bi** = Inner E-Chain® width
- FZ<sub>max</sub>** = Max. additional load
- H** = Nominal clearance height
- ha** = Outer E-Chain® height
- hi** = Inner E-Chain® height
- H<sub>F</sub>** = Required clearance height incl. 50 mm clearance
- IR** = Inner radius, E-Chain®
- K** = Series-dependent add-on for bending radius
- n** = Number of links
- R** = Bending radius
- T** = Pitch
- v** = Speed
- X<sub>1</sub>** = Inner machine construction space
- X<sub>2</sub>** = Outer radius, incl. clearance
- R<sub>LK</sub>** = Distance pivot point/ outer mounting holes

TwisterChain®-System  
Inner height: 28-56 mm

Phone +49- (0) 22 03-96 49-800  
Fax +49- (0) 22 03-96 49-222

### Recommendations for design without additional components

E-Chain® Series	FZ <sub>max.</sub> $\alpha$ 180° [kg/m]	FZ <sub>max.</sub> $\alpha$ 360° [kg/m]	v an AR permitted [m/s]	a an AR [m/s²] max.	R max. [mm]	AR permitted [mm]
2208.	1	1	0,3 - 1	2	100	300
2808.	2	1	0,3 - 1	2	150	450 - 550
3808.	3	1,8	0,3 - 1	2	200	450 - 550
4008.	4	2,5	0,3 - 1	2	250	600 - 700

The following clearances are absolutely essential for proper design function:

- $IR_{min} = X_1 + 80$  mm
- $X_{2 min} = AR + 80$  mm
- $H_F = H + 50$  mm

If your calculations exceed our recommendations, please talk to us.

We offer special solutions and many additional components!

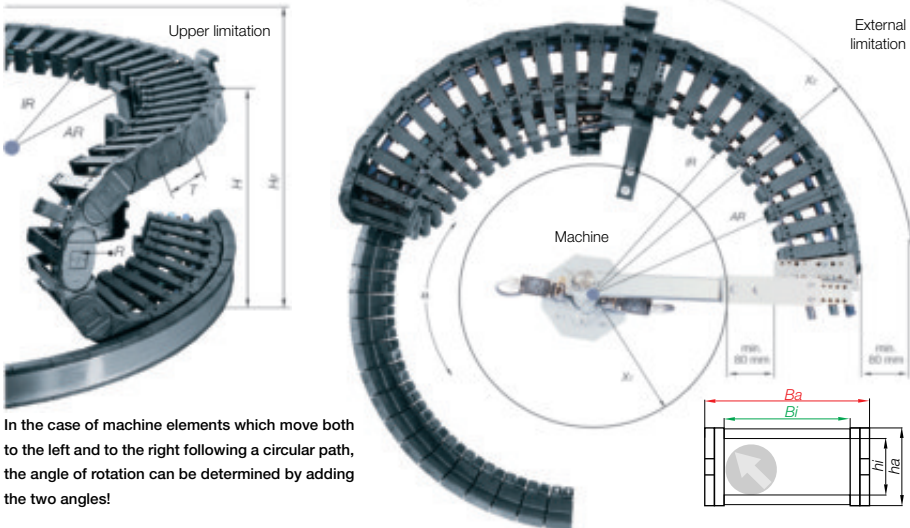

In the case of machine elements which move both to the left and to the right following a circular path, the angle of rotation can be determined by adding the two angles!

Serie 2208 - snap-open along inner and outer radius

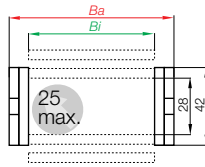

R [mm]	K	T [mm]
055	265	044
063	290	044
075	330	044
100	410	044
125	485	044
150	565	044

Part No. structure

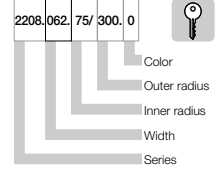

Bi [mm]	Ba [mm]	AR [mm]	IR [mm]	R 055 mm 2208...	R 063 mm 2208...	R 075 mm 2208...	R 100 mm 2208...	R 125 mm 2208...	R150 mm 2208...	Weights [kg/m]
52,5	80	300	227	.052.55/300	.052.63/300	.052.75/300	.052.100/300	.052.125/300	.052.150/300	= 1,20
62,5	90	300	217	-	-	.062.75/300	.062.100/300	.062.125/300	.062.150/300	= 1,24
74,5	102	300	205	-	-	-	.074.100/300	.074.125/300	.074.150/300	= 1,29
87,5	115	300	192	-	-	-	.087.100/300	.087.125/300	.087.150/300	= 1,35
112,5	140	300	167	-	-	-	-	.112.125/300	.112.150/300	= 1,46



Interior separation - For this Series the interior separation elements of Series 220 E4/00 may be used (except side-plates) ► page 7.18



Serie 2808 - snap-open along inner and outer radius

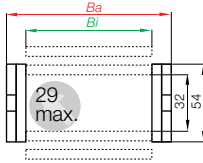
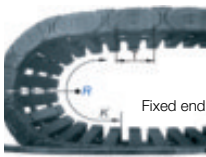

R [mm]	K	T [mm]
100	465	056
125	550	056
150	620	056
175	700	056
200	780	056
250	940	056

Part No. structure

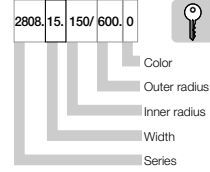

Bi [mm]	Ba [mm]	AR [mm]	IR [mm]	R 100 mm 2808...	R 125 mm 2808...	R 150 mm 2808...	R 175 mm 2808...	R 200 mm 2808...	R 250 mm 2808...	Weights [kg/m]
50	81	400	329,5	.05.100/400	.05.125/400	.05.150/400	.05.175/400	.05.200/400	.05.250/400	~ 1,76
68	99	400	311,5	.06.100/400	.06.125/400	.06.150/400	.06.175/400	.06.200/400	.06.250/400	~ 1,87
75	106	400	304,5	.07.100/400	.07.125/400	.07.150/400	.07.175/400	.07.200/400	.07.250/400	~ 1,92
87,5	118,5	400	292	.087.100/400	.087.125/400	.087.150/400	.087.175/400	.087.200/400	.087.250/400	~ 1,99
100	131	400	279,5	-	-	.10.150/400	.10.175/400	.10.200/400	.10.250/400	~ 2,07
108	139	400	271,5	-	-	-	.11.175/400	.11.200/400	.11.250/400	~ 2,12
125	156	400	254,5	-	-	-	.12.175/400	.12.200/400	.12.250/400	~ 2,22
137,5	168,5	400	242	-	-	-	-	.137.250/400	.137.250/400	~ 2,30
150	181	400	229,5	-	-	-	-	.15.250/400	.15.250/400	~ 2,38
50	81	500	429,5	.05.100/500	.05.125/500	.05.150/500	.05.175/500	.05.200/500	.05.250/500	~ 1,76
68	99	500	411,5	.06.100/500	.06.125/500	.06.150/500	.06.175/500	.06.200/500	.06.250/500	~ 1,87
75	106	500	404,5	.07.100/500	.07.125/500	.07.150/500	.07.175/500	.07.200/500	.07.250/500	~ 1,92
87,5	118,5	500	392	.087.100/500	.087.125/500	.087.150/500	.087.175/500	.087.200/500	.087.250/500	~ 1,99
100	131	500	379,5	.10.100/500	.10.125/500	.10.150/500	.10.175/500	.10.200/500	.10.250/500	~ 2,07
108	139	500	371,5	-	.11.125/500	.11.150/500	.11.175/500	.11.200/500	.11.250/500	~ 2,12
125	156	500	354,5	-	.12.125/500	.12.150/500	.12.175/500	.12.200/500	.12.250/500	~ 2,22
137,5	168,5	500	342	-	-	.137.150/500	.137.175/500	.137.200/500	.137.250/500	~ 2,30
150	181	500	329,5	-	-	.15.150/500	.15.175/500	.15.200/500	.15.250/500	~ 2,38
50	81	600	529,5	.05.100/600	.05.125/600	.05.150/600	.05.175/600	.05.200/600	.05.250/600	~ 1,76
68	99	600	511,5	.06.100/600	.06.125/600	.06.150/600	.06.175/600	.06.200/600	.06.250/600	~ 1,87
75	106	600	504,5	.07.100/600	.07.125/600	.07.150/600	.07.175/600	.07.200/600	.07.250/600	~ 1,92
87,5	118,5	600	492	.087.100/600	.087.125/600	.087.150/600	.087.175/600	.087.200/600	.087.250/600	~ 1,99
100	131	600	479,5	.10.100/600	.10.125/600	.10.150/600	.10.175/600	.10.200/600	.10.250/600	~ 2,07
108	139	600	471,5	.11.100/600	.11.125/600	.11.150/600	.11.175/600	.11.200/600	.11.250/600	~ 2,12
125	156	600	454,5	-	.12.125/600	.12.150/600	.12.175/600	.12.200/600	.12.250/600	~ 2,22
137,5	168,5	600	442	-	.137.125/600	.137.150/600	.137.175/600	.137.200/600	.137.250/600	~ 2,30
150	181	600	429,5	-	-	.15.150/600	.15.175/600	.15.200/600	.15.250/600	~ 2,38



Interior separation - For this Series the interior separation elements of Series 280 E4/00 may be used (except side-plates) ▶ page 7.26



TwisterChain®-System  
Inner height: 28-56 mm

Phone +49- (0) 22 03-96 49-800  
Fax +49- (0) 22 03-96 49-222



## Serie 3808 - snap-open along inner and outer radius

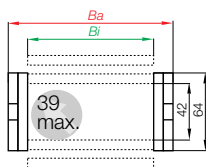

R [mm]	K	T [mm]
100	500	067
125	650	067
150	725	067
200	875	067
250	1050	067

## Part No. structure

3808.20.200.600.0



Color  
Outer radius  
Inner radius  
Width  
Series

igus® E-ChainsSystems®

Phone +49- (0) 22 03-96 49-800  
Fax +49- (0) 22 03-96 49-222igus® GmbH  
51147 CologneInternet: www.igus.de  
E-mail: info@igus.de

Bi [mm]	Ba [mm]	AR [mm]	IR [mm]	R 100 mm 3808...	R 125 mm 3808...	R 150 mm 3808...	R 200 mm 3808...	R 250 mm 3808...	Weights [kg/m]
50	85	400	327,5	.05.100/400	.05.125/400	.05.150/400	.05.200/400	.05.250/400	≈ 2,21
68	103	400	309,5	.06.100/400	.06.125/400	.06.150/400	.06.200/400	.06.250/400	≈ 2,30
75	110	400	302,5	.07.100/400	.07.125/400	.07.150/400	.07.200/400	.07.250/400	≈ 2,33
87,5	122,5	400	290	.087.100/400	.087.125/400	.087.150/400	.087.200/400	.087.250/400	≈ 2,40
100	135	400	277,5	.10.100/400	.10.125/400	.10.150/400	.10.200/400	.10.250/400	≈ 2,46
108	143	400	269,5	-	.11.125/400	.11.150/400	.11.200/400	.11.250/400	≈ 2,50
125	160	400	252,5	-	.12.125/400	.12.150/400	.12.200/400	.12.250/400	≈ 2,59
137,5	172,5	400	240	-	.137.125/400	.137.150/400	.137.200/400	.137.250/400	≈ 2,65
150	185	400	227,5	-	-	-	.15.200/400	.15.250/400	≈ 2,72
162,5	197,5	400	215	-	-	-	.162.200/400	.162.250/400	≈ 2,78
168	203	400	209,5	-	-	-	-	.17.250/400	≈ 2,81
175	210	400	202,5	-	-	-	-	.18.250/400	≈ 2,84
187,5	222,5	400	190	-	-	-	-	-	≈ 2,91
200	235	400	177,5	-	-	-	-	-	≈ 2,97
50	85	500	427,5	.05.100/500	.05.125/500	.05.150/500	.05.200/500	.05.250/500	0= 2,21
68	103	500	409,5	.06.100/500	.06.125/500	.06.150/500	.06.200/500	.06.250/500	≈ 2,30
75	110	500	402,5	.07.100/500	.07.125/500	.07.150/500	.07.200/500	.07.250/500	≈ 2,33
87,5	122,5	500	390	.087.100/500	.087.125/500	.087.150/500	.087.200/500	.087.250/500	≈ 2,40
100	135	500	377,5	.10.100/500	.10.125/500	.10.150/500	.10.200/500	.10.250/500	≈ 2,46
108	143	500	369,5	-	.11.125/500	.11.150/500	.11.200/500	.11.250/500	≈ 2,50
125	160	500	352,5	-	.12.125/500	.12.150/500	.12.200/500	.12.250/500	≈ 2,59
137,5	172,5	500	340	-	-	.137.150/500	.137.200/500	.137.250/500	≈ 2,65
150	185	500	327,5	-	-	.15.150/500	.15.200/500	.15.250/500	≈ 2,72
162,5	197,5	500	315	-	-	-	.162.200/500	.162.250/500	≈ 2,78
168	203	500	309,5	-	-	-	.17.200/500	.17.250/500	≈ 2,81
175	210	500	302,5	-	-	-	.18.200/500	.18.250/500	≈ 2,84
187,5	222,5	500	290	-	-	-	.187.200/500	.187.250/500	≈ 2,91
200	235	500	277,5	-	-	-	.20.200/500	.20.250/500	≈ 2,97
50	85	600	527,5	.05.100/600	.05.125/600	.05.150/600	.05.200/600	.05.250/600	≈ 2,21
68	103	600	509,5	.06.100/600	.06.125/600	.06.150/600	.06.200/600	.06.250/600	≈ 2,30
75	110	600	502,5	.07.100/600	.07.125/600	.07.150/600	.07.200/600	.07.250/600	≈ 2,33
87,5	122,5	600	490	.087.100/600	.087.125/600	.087.150/600	.087.200/600	.087.250/600	≈ 2,40
100	135	600	477,5	.10.100/600	.10.125/600	.10.150/600	.10.200/600	.10.250/600	≈ 2,46
108	143	600	469,5	.11.100/600	.11.125/600	.11.150/600	.11.200/600	.11.250/600	≈ 2,50
125	160	600	452,5	.12.100/600	.12.125/600	.12.150/600	.12.200/600	.12.250/600	≈ 2,59
137,5	172,5	600	440	.137.100/600	.137.125/600	.137.150/600	.137.200/600	.137.250/600	≈ 2,65
150	185	600	427,5	.15.100/600	.15.125/600	.15.150/600	.15.200/600	.15.250/600	≈ 2,72
162,5	197,5	600	415	-	-	-	.162.200/600	.162.250/600	≈ 2,78
168	203	600	409,5	-	-	-	.17.200/600	.17.250/600	≈ 2,81
175	210	600	402,5	-	-	-	.18.200/600	.18.250/600	≈ 2,84
187,5	222,5	600	390	-	-	-	.187.200/600	.187.250/600	≈ 2,91
200	235	600	377,5	-	-	-	.20.200/600	.20.250/600	≈ 2,97



Interior separation - For this Series the interior separation elements of Series 380 E4/00 may be used ▶ page 7.36



Serie 4008 - snap-open along inner and outer radius

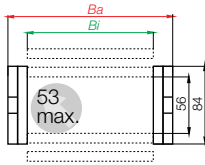
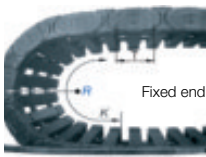

R [mm]	K	T [mm]
150	750	091
200	900	091
250	1050	091
300	1225	091
400	1450	091

Part No. structure

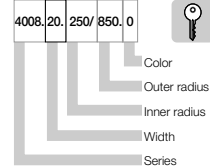

Bi [mm]	Ba [mm]	AR [mm]	IR [mm]	R 150 mm 4008...	R 200 mm 4008...	R 250 mm 4008...	R 300 mm 4008...	R 400 mm 4008...	Weights [kg/m]
50	93	650	572	.05.150/650	.05.200/650	.05.250/650	.05.300/650	.05.400/650	~ 3,28
65	108	650	557	.06.150/650	.06.200/650	.06.250/650	.06.300/650	.06.400/650	~ 3,38
75	118	650	547	.07.150/650	.07.200/650	.07.250/650	.07.300/650	.07.400/650	~ 3,44
100	143	650	522	-	.10.200/650	.10.250/650	.10.300/650	.10.400/650	~ 3,61
112	155	650	510	-	.11.200/650	.11.250/650	.11.300/650	.11.400/650	~ 3,69
125	168	650	497	-	.12.200/650	.12.250/650	.12.300/650	.12.400/650	~ 3,77
137,5	180,5	650	484,5	-	-	.13.250/650	.13.300/650	.13.400/650	~ 3,86
150	193	650	472	-	-	.15.250/650	.15.300/650	.15.400/650	~ 3,94
162,5	205,5	650	459,5	-	-	.16.250/650	.16.300/650	.16.400/650	~ 4,02
175	218	650	447	-	-	-	.17.300/650	.17.400/650	~ 4,10
187,5	230,5	650	434,5	-	-	-	.18.300/650	.18.400/650	~ 4,19
200	243	650	422	-	-	-	-	-	~ 4,27

50	93	750	672	.05.150/750	.05.200/750	.05.250/750	.05.300/750	.05.400/750	~ 3,28
65	108	750	657	.06.150/750	.06.200/750	.06.250/750	.06.300/750	.06.400/750	~ 3,38
75	118	750	647	.07.150/750	.07.200/750	.07.250/750	.07.300/750	.07.400/750	~ 3,44
100	143	750	622	.10.150/750	.10.200/750	.10.250/750	.10.300/750	.10.400/750	~ 3,61
112	155	750	610	.11.150/750	.11.200/750	.11.250/750	.11.300/750	.11.400/750	~ 3,69
125	168	750	597	-	.12.200/750	.12.250/750	.12.300/750	.12.400/750	~ 3,77
137,5	180,5	750	584,5	-	.13.200/750	.13.250/750	.13.300/750	.13.400/750	~ 3,86
150	193	750	572	-	.15.200/750	.15.250/750	.15.300/750	.15.400/750	~ 3,94
162,5	205,5	750	559,5	-	.16.200/750	.16.250/750	.16.300/750	.16.400/750	~ 4,02
175	218	750	547	-	-	.17.250/750	.17.300/750	.17.400/750	~ 4,10
187,5	230,5	750	534,5	-	-	.18.250/750	.18.300/750	.18.400/750	~ 4,19
200	243	750	522	-	-	.20.250/750	.20.300/750	.20.400/750	~ 4,27

50	93	850	772	.05.150/850	.05.200/850	.05.250/850	.05.300/850	.05.400/850	~ 3,28
65	108	850	757	.06.150/850	.06.200/850	.06.250/850	.06.300/850	.06.400/850	~ 3,38
75	118	850	747	.07.150/850	.07.200/850	.07.250/850	.07.300/850	.07.400/850	~ 3,44
100	143	850	722	.10.150/850	.10.200/850	.10.250/850	.10.300/850	.10.400/850	~ 3,61
112	155	850	710	.11.150/850	.11.200/850	.11.250/850	.11.300/850	.11.400/850	~ 3,69
125	168	850	697	.12.150/850	.12.200/850	.12.250/850	.12.300/850	.12.400/850	~ 3,77
137,5	180,5	850	684,5	-	.13.200/850	.13.250/850	.13.300/850	.13.400/850	~ 3,86
150	193	850	672	-	.15.200/850	.15.250/850	.15.300/850	.15.400/850	~ 3,94
162,5	205,5	850	659,5	-	.16.200/850	.16.250/850	.16.300/850	.16.400/850	~ 4,02
175	218	850	647	-	.17.200/850	.17.250/850	.17.300/850	.17.400/850	~ 4,10
187,5	230,5	850	634,5	-	.18.200/850	.18.250/850	.18.300/850	.18.400/850	~ 4,19
200	243	850	622	-	-	.20.250/850	.20.300/850	.20.400/850	~ 4,27

Interior separation - For this Series the interior separation elements of Series 400 E4/00 may be used ► page 7.46



TwisterChain® -System  
Inner height: 28-56 mm

Phone +49- (0) 22 03-96 49-800  
Fax +49- (0) 22 03-96 49-222



► page 2.61



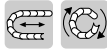

**Steel mounting brackets**

- One part for all chain widths
- Electrically conductive
- Universal use
- Material: Stainless steel: 1.4301



Part 1

Part 2



**Dimensions and order configurations**

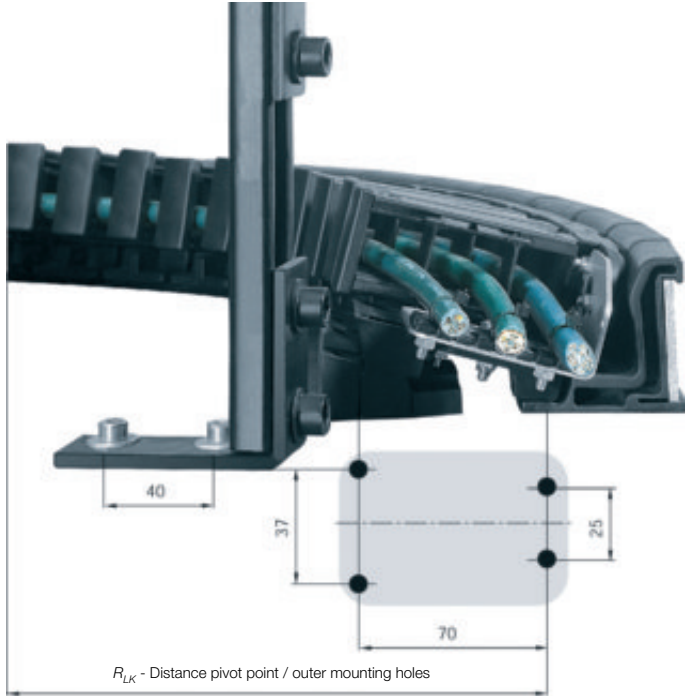

Phone +49- (0) 22 03-96 49-800  
Fax +49- (0) 22 03-96 49-222

igus® GmbH  
51147 Cologne

**Part No. structure**

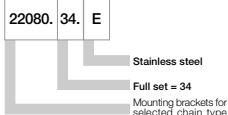

For	Part No.	Part No.	Part No.
E-Chain®	Full set	Part 1	Part 2
2208	22080. [34] .E	22080. [30] .E	22080. [40] .E
2808	28080. [34] .E	28080. [30] .E	28080. [40] .E
3808	38080. [34] .E	38080. [30] .E	38080. [40] .E
4008	40080. [34] .E	40080. [30] .E	40080. [40] .E

**Full set, for both ends**

22080. [34] .E

**Single-part order - Part 1:**

22080. [30] .E

**Single-part order - Part 2:**

22080. [40] .E

The guide trough must be mounted at the fixed point of the TwisterChain®, as shown by the drilling template in the illustration. The following bolted connections are permitted:

- Bore Hole: 4 x Ø 6,6 - 7 mm
- Mounting only with bolts: 4 x bolts M6

Other connection dimensions for mounting the guide trough ► from page 2.71

Internet: [www.igus.de](http://www.igus.de)  
E-mail: [info@igus.de](mailto:info@igus.de)



TwisterChain® for continuous industrial duty in 3-shift operation on a buckling arm robot (for welding applications, rotary movement 420°)



TwisterChain® in a guide trough for rotary movements on an articulated robot

TwisterChain® - System  
Inner height: 28-56 mm

Phone +49- (0) 22 03-96 49-800  
Fax +49- (0) 22 03-96 49-222





This bottom support is required only if the support for the upper run (from a 180° rotation angle) cannot be mounted on the machine

igus® E-ChainSystems®

### Guide Troughs - TwisterChain®

The delivery of an igus® TwisterChain® includes the guide trough, which offers certain advantages:

- Guidance of the chain
- Minimized wear on the chain
- Optimal running smoothness
- Rotation angle up to 400°

The modular design of the guide trough makes it possible to connect a large number of chain, circle and bending radii by using the same trough sections. If the chain radius changes, the trough can simply be adapted without purchasing a completely new trough. The table below will assist you in selecting the right guide trough system. The specified part number includes the complete trough system. In all cases, you should state the TwisterChain® type when ordering.

Phone +49- (0) 22 03-96 49-800  
Fax +49- (0) 22 03-96 49-222

9	<u>4008</u>	5. 180.	600/	06.	250
---	-------------	---------	------	-----	-----

9	XXXX	5. 180.	600/	Bi XXX	R XXX
---	------	---------	------	--------	-------

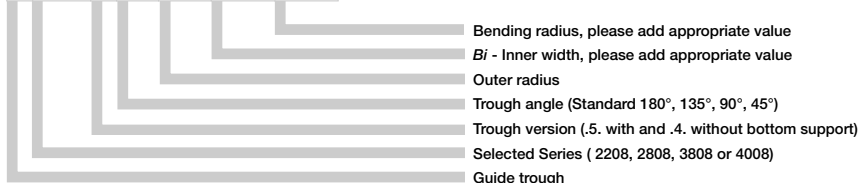

Part No. structure - guide trough  
94008.5.180.600/06.250

igus® GmbH  
51147 Cologne

Part No. Series	Outer radius AR [mm]	Rotation angle α [°]	Trough assembly		Trough assembly with bottom support	Number of support
			Standard			
2208	- 300	45 - 100	9 [2208]	.4.45.300/ Bi XXX .R XXX	not necessary	
	- 300	>100 - 180	9 [2208]	.4.90.300/ Bi XXX .R XXX	not necessary	
	- 300	>180 - 270	9 [2208]	.4.135.300/ Bi XXX .R XXX *	9 [2208]	.5.135.300/ Bi XXX .R XXX 1
	- 300	>270 - 360	9 [2208]	.4.180.300/ Bi XXX .R XXX **	9 [2208]	.5.180.300/ Bi XXX .R XXX 2

2808 / 3808 / 4008	- 450	45 - 100	9 [XXXX]	.4.45.400/ Bi XXX .R XXX	not necessary	
	- 450	>100 - 180	9 [XXXX]	.4.90.400/ Bi XXX .R XXX	not necessary	
	- 450	>180 - 270	9 [XXXX]	.4.135.400/ Bi XXX .R XXX *	9 [XXXX]	.5.135.400/ Bi XXX .R XXX 1
	- 450	>270 - 360	9 [XXXX]	.4.180.400/ Bi XXX .R XXX **	9 [XXXX]	.5.180.400/ Bi XXX .R XXX 2
	>450-550	45 - 100	9 [XXXX]	.4.45.500/ Bi XXX .R XXX	not necessary	
	>450-550	>100 - 180	9 [XXXX]	.4.90.500/ Bi XXX .R XXX	not necessary	
	>450-550	>180 - 270	9 [XXXX]	.4.135.500/ Bi XXX .R XXX *	9 [XXXX]	.5.135.500/ Bi XXX .R XXX 1
	>450-550	>270 - 360	9 [XXXX]	.4.180.500/ Bi XXX .R XXX **	9 [XXXX]	.5.180.500/ Bi XXX .R XXX 2
	>550-650	45 - 100	9 [XXXX]	.4.45.600/ Bi XXX .R XXX	not necessary	
	>550-650	>100 - 180	9 [XXXX]	.4.90.600/ Bi XXX .R XXX	not necessary	
>550-650	>180 - 270	9 [XXXX]	.4.135.600/ Bi XXX .R XXX *	9 [XXXX]	.5.135.600/ Bi XXX .R XXX 1	
>550-650	>270 - 360	9 [XXXX]	.4.180.600/ Bi XXX .R XXX **	9 [XXXX]	.5.180.600/ Bi XXX .R XXX 2	
>650	>360	Ask us, we will be pleased to help you.				

Supplement Part No. with required Series (2208, 2808, 3808 oder 4008), value *Bi*, and appropriate value of the required radius *R* ▶ 9 [4008] .5.180.600/ [06] [250]

\*These troughs feature **one support** for the upper run

\*\*These troughs feature **two supports** for the upper run

Internet: www.igus.de  
E-mail: info@igus.de

Support for the upper run (as of 180° rotation angle)

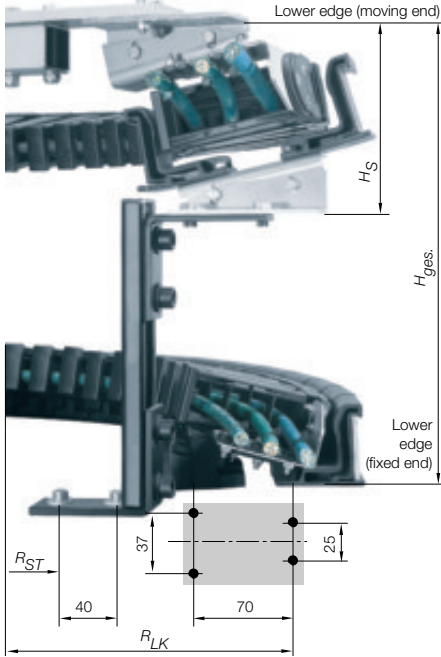

The guide trough must be mounted at the fixed end of the TwisterChain® as shown by the drilling template. The following bolted connections are permitted:

- Bolt hole: 4 x Ø 6,6 - 7 mm
- Mounting only with bolts: 4 x bolt M6

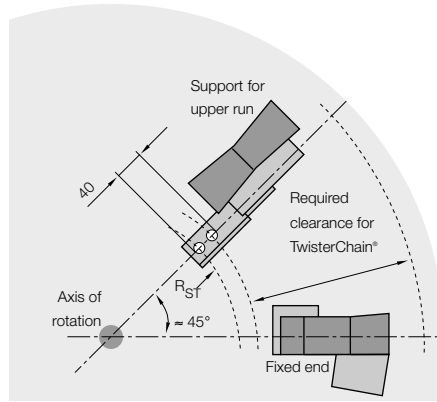

Mounting position for one support

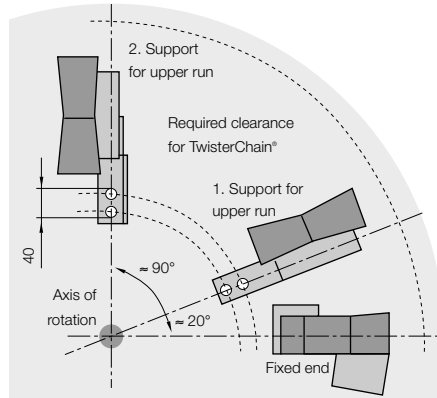

Mounting position for two supports

Installation Dimensions

Series	R <sub>LK</sub> [mm]	H <sub>S</sub> [mm]	H <sub>tot</sub> [mm] for bending radius											Part No. guide trough	R <sub>ST</sub> [mm]	
			R055	R063	R075	R100	R125	R150	R175	R200	R250	R300	R400			
2208...300	265	130	195	211	235	285	335	385	-	-	-	-	-	-	92208...300	145
2808...400	360	146	-	-	-	290	340	390	440	490	590	-	-	-	92808...400	192,5
3808...400	460	156	-	-	-	300	350	400	-	500	600	-	-	-	93808...400	192,5
2808...500	460	146	-	-	-	300	350	400	450	500	600	-	-	-	92808...500	292,5
3808...500	460	156	-	-	-	310	360	410	-	510	610	-	-	-	93808...500	292,5
2808...600	560	146	-	-	-	305	355	405	455	505	605	-	-	-	92808...600	392,5
3808...600	560	156	-	-	-	315	365	415	-	515	615	-	-	-	93808...600	392,5
4008...650	610	176	-	-	-	-	-	432	-	532	632	732	932	-	94008...650	442,5
4008...750	710	176	-	-	-	-	-	432	-	532	632	732	932	-	94008...750	542,5

TwisterChain®-System  
Inner height: 28-56 mm

Phone +49- (0) 22 03-96 49-800  
Fax +49- (0) 22 03-96 49-222



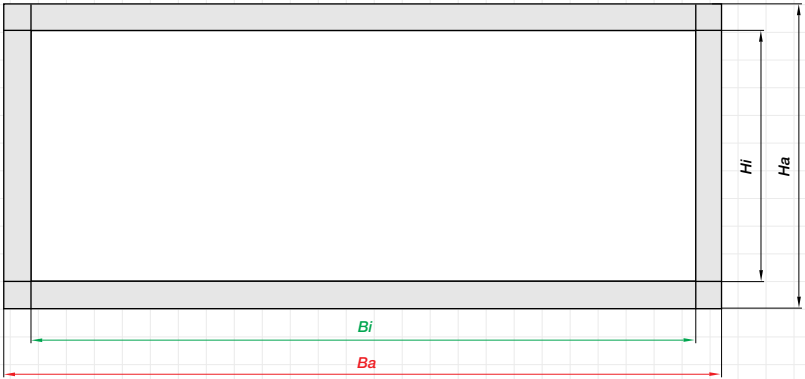

### Calculation assistance

This calculation sheet should help you to select the right igus® TwisterChain® System for your application.  
Rotation angle [°].....

### Rotation angle

Please sketch the cable and hose layout within the chain.

**Note:** To find the correct Series, refer to the thickest cable diameter, plus cable clearance of approx. 20% of the chain interior.

TwisterChain® Series     2208     2808     3808     4008

### Existing installation space

$X_1$  max.....     $X_2$  max.....     $H_z$  max.....

### E-Chain® data

Outer radius  $AR$ .....    Inner radius  $IR$  .....    Bending radius  $R$  .....

Guide trough     yes     no

Part No. trough    9 \_ \_ \_ . \_ \_ \_ . \_ \_ \_ . / \_ \_ \_ . \_ \_ \_

Supporting structure necessary     yes     no

The guide trough part number includes all the necessary elements for proper operation. The rotation angle is dependent upon support for the upper run and should be assembled on-site. If on-site assembly is not possible, we will deliver a supporting structure which can be assembled on the floor and is based on the height of the lower trough run. If necessary, we will design a supporting structure specially adapted to your installation!

<b>Date:</b>	<b>Phone:</b> +49- (0) 22 03 96 49 - 800 <b>Fax:</b> +49- (0) 22 03 96 49 - 222
<b>From:</b>	<b>To:</b> <b>igus® GmbH</b> Technical Sales Energy Chain Systems® P.O. Box 90 61 23 51147 Spicher Str. 1a
<b>Phone:</b>	
<b>Fax:</b>	

TwisterChain®-System  
Inner height: 28-56 mm

Please supply us with your application data. We will then send you a full analysis with cable/layout suggestion and a quotation immediately. Please consult igus® should you have any questions..

**Individual components**

TwisterChain®    
  Chainflex® high-flex cables    
  Guide Trough    
  Preassembled

Phone +49- (0) 22 03-96 49-800  
Fax +49- (0) 22 03-96 49-222

**Filling - TwisterChain®**

Number	Type	Ø [mm]	Weight [kg/m]	Permitted bending radius R [mm]

**Dimensions**

$X_1$  [mm] .....  
 $X_2$  [mm] .....  
 $H_F$  [mm] .....  
 Rotation angle  $\alpha^*$  [°] .....

\* On machine elements which move to the left and to the right following a circular path, the rotation angle can be determined by adding the two angles.

**Operating data**

Rotations/day .....  
 Days/year .....  
 Speed [°/s] .....  
 Acceleration [°/s²] .....

**Environment**

Temperature [°C] .....

Moisture  yes  no

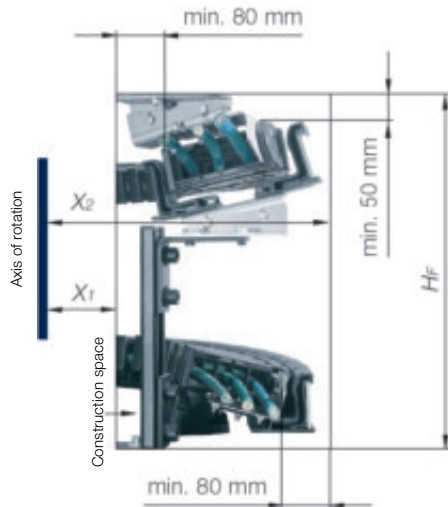

igus® GmbH  
51147 Cologne

Internet: [www.igus.de](http://www.igus.de)  
E-mail: [info@igus.de](mailto:info@igus.de)



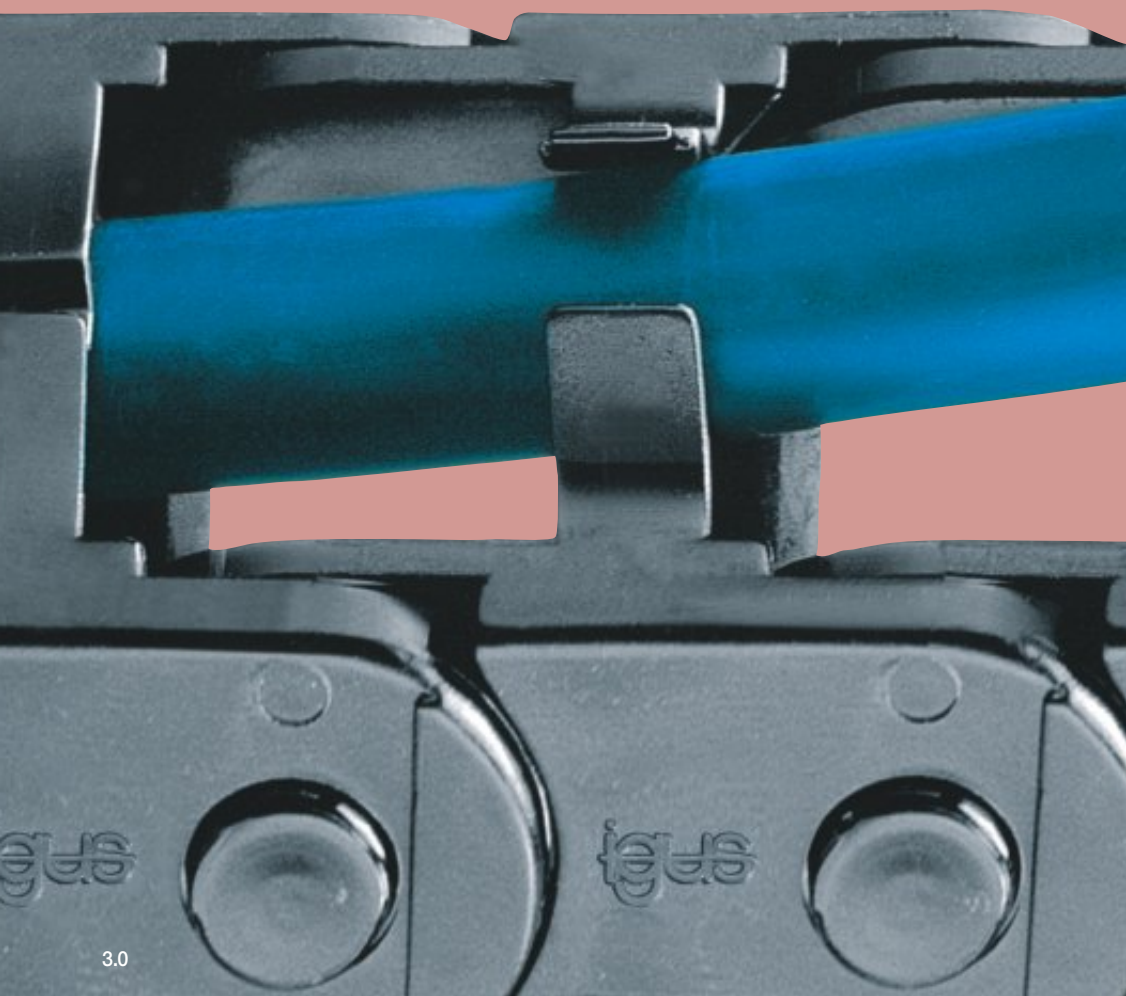

SPHS

SPHS

# Easy Chain<sup>®</sup>

CHAINFLEX<sup>®</sup>



"Press Fit" principle for secure halt of E-Chain® links

Stable stop dog

Simply press cables in

Cable-friendly, smooth interior

Material igumid NB -30/+100°C



## Easy Chain®: "E" and "Z" makes "Easy"

- Easy to fill from the inner radius (Version "Z") or outer (exterior) radius (Version "E")
- Fast cable accessibility without opening and closing lids
- Easy to lengthen and shorten at any point
- Low price with one-piece design
- Dirt-repellent, contoured exterior
- Mounting brackets available with integrated strain relief
- Limited torsion tolerance
- Available with interior separation (some types)
- Flammability rating UL94-V2
- Suitable for clean-room applications
- You can find more technical data about the material, chemical resistance, temperatures ► **chapter design, from page 1.38**

### Opening-principle



Simply press in cable along the outer radius (Version "E")

Simply press in cable along the inner radius (Version "Z")

### Dimensioning

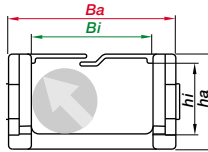

### Bending radius

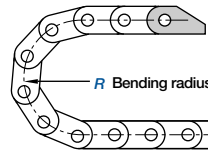

### Part No. structure

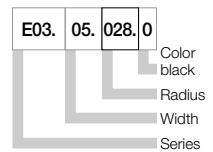

### Selection table

Series	Inner height <i>hi</i> [mm]	Inner width <i>Bi</i> [mm]	Outer width <i>Ba</i> [mm]	Outer height <i>ha</i> [mm]	Bending radius <i>R</i> [mm]	Unsupported length max. [m]	Page
E03	5	5 - 10	8,7 - 13,7	8	10 - 28	0,40	3.6
E04	7	7	13	10	15 - 48	0,55	3.10
E045-Z045	9,4	10 - 27	16 - 37	12,5	18 - 38	0,40	3.14
E06-Z06	10,5 / 10,7	10 - 16	16,5 - 22,5	15	18 - 38	0,55	3.20
E065 <b>NEW!</b>	11,4	10 - 36	18,8 - 49,3	15	18 - 38	0,60	3.24
E08-Z08	14,6 / 14,7	10 - 50	18,2 - 58,2	19,3	28 - 48	1	3.28
E14-Z14	19	15 - 50	27 - 62	25	28 - 125	0,65	3.32
E200-Z200	24,3	37 - 57	74,4 - 120,4	35	55 - 200	1,75	3.36
E16-Z16	32	23 - 100	37,5 - 115,3	39	40 - 125	1	3.42
E26-Z26	36,5 / 37,1	48 - 75	92 - 167	50	63 - 250	2	3.46
E300-Z300	48,5	48 - 75	95 - 170	64	75 - 300	2,25	3.52

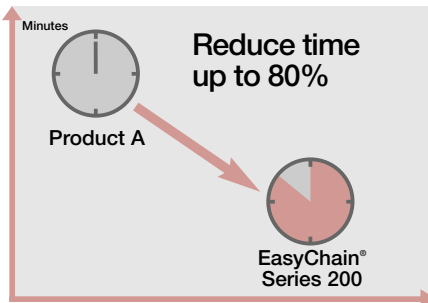

Assembly time: Insert of 2 cables Ø 6 and 10 mm - We can present you with more details about this and other tests



Just push the cables with your thumb into the E-Chain® - and it's ready

## Comparison of the main characteristics

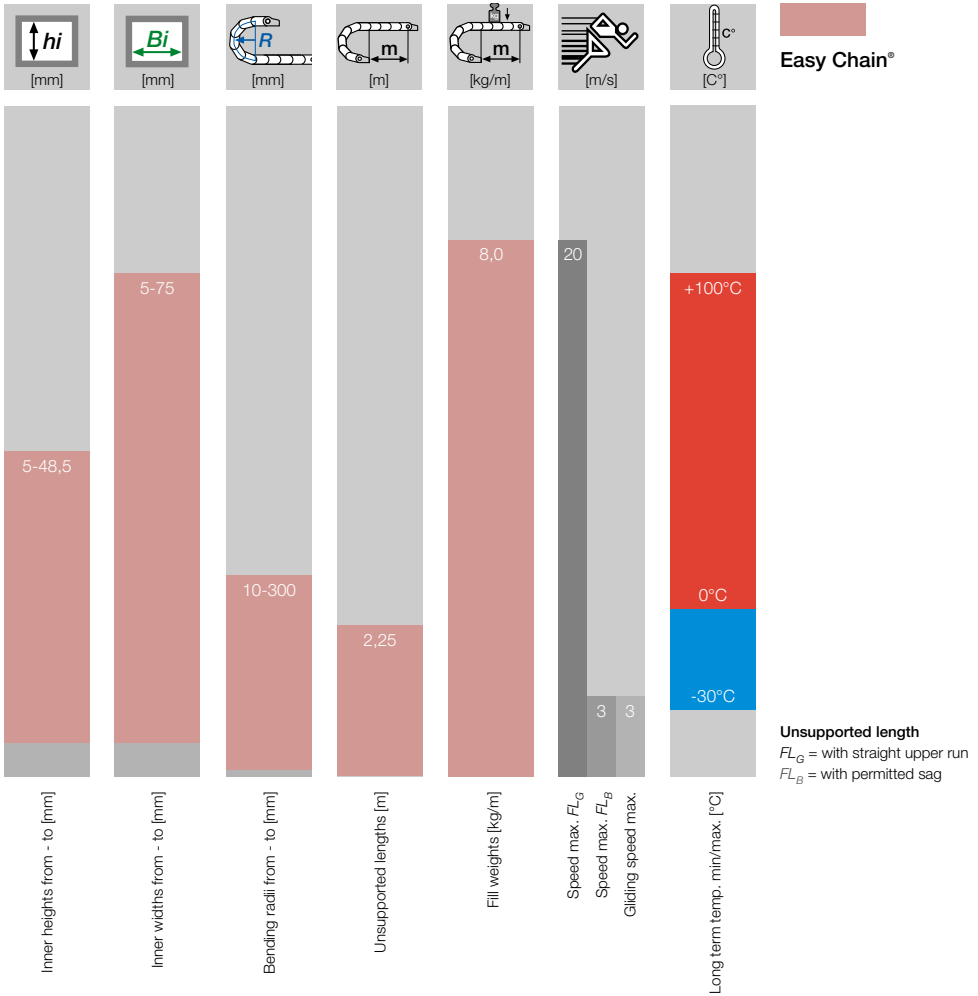

### Additional quality features - Easy Chain®

IPA Qualification Certificate: Air Cleanless Class ISO Class 2 (at  $v = 1$  m/s) upon request



IPA Qualification Certificate: ESD Classification Level 1 (for Series E14.3.038) Special equipment: Electrically conductive ESD/ATEX version upon request

UL94-V2 classifications



Just push the cables with your thumb into the E-Chain® - and it's ready

With Easy Chain® rotatory and torsional motions are possible

► Next Page: Find application examples and assembly instructions Torsional motion possible

Easy Chains® are available with **exterior (E)** press-in-access, as well as **interior (Z)** access. The assembly time reductions are a primary reason to choose Easy Chains®. Their elastic and tough material igumid NB presents more application reasons: Same optimal elasticity, UL94-V2 classification and excellent cleanroom qualities. Their one-piece design makes the Easy Chain® very price-attractive. Don't use it for the highest load applications, because the material has a lower rigidity.

**Typical industries and applications**

- Cleanroom applications ● Electronic apparatus ● Office equipment
- Vending machines ● Wood machinery ● Glass machinery ● Automation ● General machinery etc.



Machinery of all kinds feature Easy Chains® - and reduce assembly time



Combine "E" and "Z" styles (exterior and inner access) if desivable



Easy Chain® Series E14 on server unit, removable for maintenance purposes Cleanroom Class 1 ISO is standard

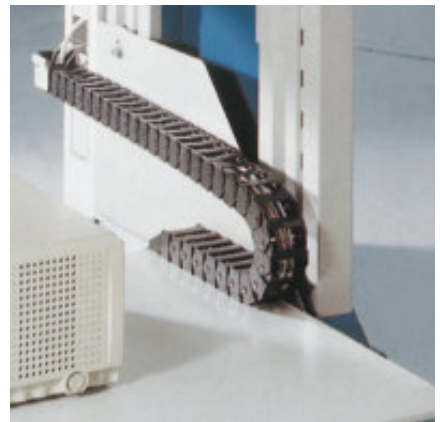

Easy Chain® on adjustable office furniture with UL94 - V2 Classification

**Assembling | Separating | Filling** | Series E03 · E04 · EZ/045



1 Twist and click or twist and divide



2 Press in cable

**Assembling** | Series E/Z06 · E065 · E/Z08 · E/Z14 · E/Z200 · E/Z16 · E/Z26 · E/Z300



1 Push and click...



2 Snap in pin

**Separating** | Series E/Z06 · E065 · E/Z08 · E/Z14 · E/Z200 · E/Z16 · E/Z26 · E/Z300



3 Release side link



4 Twist and pull apart

**Filling** | Series E/Z06 · E065 · E/Z08 · E/Z14 · E/Z200 · E/Z16 · E/Z26 · E/Z300



5 Press in cable



6 Pull out cable







Price index



**IPA Qualification Certificate:**  
Air Cleanless Class ISO Class 2  
(at  $v = 1$  m/s) upon request



UL94-V2 classifications



Torsional motion possible



**Special equipment:**  
Electrically conductive ESD/ATEX  
version upon request



Just push the cables with your thumb  
into the E-Chain® - and it's ready

**When to use the Series E03:**

- If filling is required without opening and closing lids
- If price is an issue
- If quiet operation is required

**When not to use it:**

- Applications with very high loads and long unsupported lengths
  - ▶ Series 04 E2 micro, page 5.14
- If a E-Chain® is needed, which is not to open
  - ▶ Series 03 E2 micro, page 5.10

- ① igus® smallest E-Chain® - interior dimensions 5 x 5 mm
- ② Very easy to fill - ideal for harnessed cable assemblies, without opening and closing lids
- ③ Mounting bracket with integrated strain relief
- ④ Small pitch for low-noise, smooth operation
- ⑤ Very light weight - ideal for low fill weight
- ⑥ For smallest bending radii  
Chainflex® CF98/CF99 - 4 x d!
- ⑦ Low price
- ⑧ The patented push-button principle holds the links together

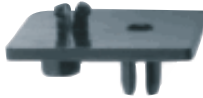

Adapter plate  
for rapid installation

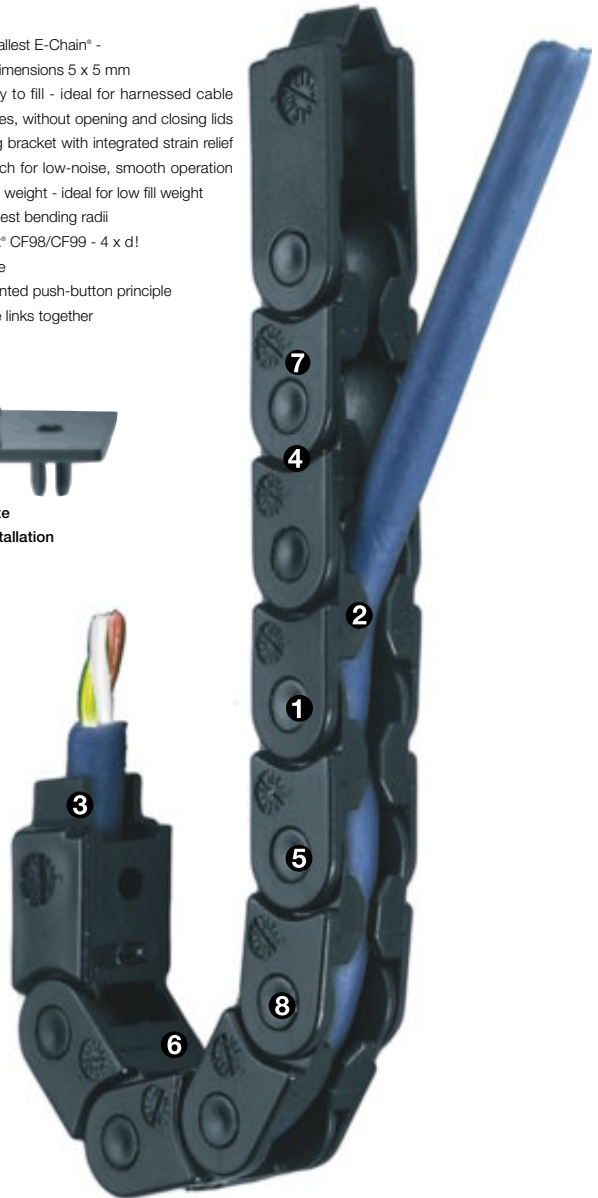
**Order example complete E-Chain®**Please indicate chain-lengths or number of links **Example: 1 m or 100 links**

1 m E03.05.010.0

E-Chain®

1 set E03.05.12Z

Mounting bracket

**Unsupported length**

$FL_G$  = with straight upper run

$FL_B$  = with permitted sag

Further information ► **Design, page 1.12**

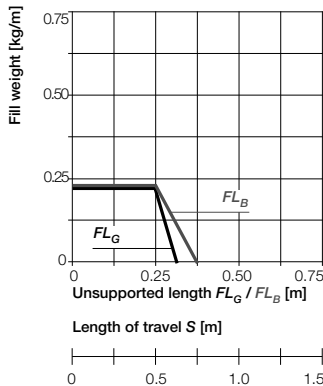
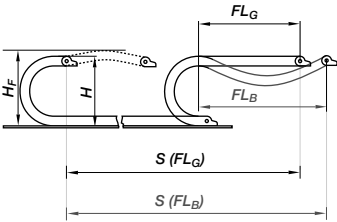

- $S$  = Length of travel
- $R$  = Bending radius
- $H$  = Nominal clearance height
- $H_F$  = Required clearance height
- $D$  = Overlength E-Chain® radius in final position
- $K = \pi \cdot R + \text{"safety"}$

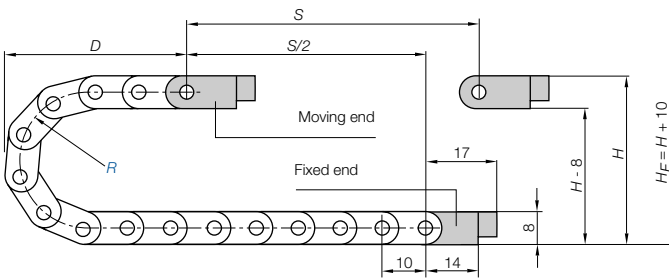

**Short travels - unsupported**

Unsupported E-Chains® feature positive camber over short travels. This must be accounted for when specifying the clearance height  $H_F$ . Please consult igus® if space is particularly restricted.

**Pitch = 10 mm/link   Links/m = 100 (1.000 mm)   Chain length =  $S/2 + K$**

$R$	010	012	015	018	028
$H$	30	34	40	46	66
$D$	25	27	30	33	43
$K$	55	60	70	80	110

The required clearance height:  
 $H_F = H + 10 \text{ mm}$   
 (with 0,1 kg/m fill weight)

**Chainflex® CF98 - tested 30 million strokes with 4xd**

TPE outer jacket, oil- and bio-oil-resistant, PVC and halogen-free, low-temperature-flexible  
 Further information: [www.igus.de/en/CF98](http://www.igus.de/en/CF98)



Speed / acceleration $FL_G$	max. 20 [m/s] / max. 200 [m/s²]
Speed / acceleration $FL_B$	max. 3 [m/s] / max. 6 [m/s²]
Gliding speed / acceleration (maximum)	max. 3 [m/s] / max. 10 [m/s²]
Material (E-Chain®)- permitted temperature °C	igumid NB / -30° up to +100° C
Material (mounting brackets)* - permitted temperature °C	igumid G / -40° up to +130° C
Flammability class (E-Chain®), igumid NB	VDE 0304 IIC UL94 V2
Flammability class (mounting brackets), igumid G*	VDE 0304 IIC UL94 HB

\*Available in igumid NB upon request, please consult igus® for delivery time

**Technical Data**



Details of material properties  
 ► page 1.38



Easy Chain®  
 Inner height: 5 mm

Phone +49- (0) 22 03-96 49-800  
 Fax +49- (0) 22 03-96 49-222



► page 3.5

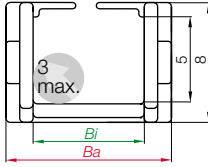

Part No. structure

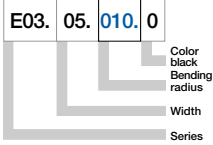

## Series E03 - split crossbar along the outer radius

Part No.	Bi [mm]	Ba [mm]	R [mm]	Bending radii				Weight [kg/m]
E03.05.□.0	5	8,7	010	012	015	018	028	~ 0,03
E03.07.□.0	7	10,7	010	012	015	018	028	~ 0,04
E03.10.□.0	10	13,7	010	012	015	018	028	~ 0,05

Ba: pin dimension approx. 0,1 - 0,3 mm wider!

Supplement Part No. with required radius. Example: E03.05.□010□.0

0 = standard color, other colors ▶ page 1.39 · Pitch = 10 mm/link - Links/m = 100





**Polymer, one-piece**

- One-piece mounting bracket
- Corrosion-resistant
- Available preassembled
- Inner and outer attachment possible
- Adapter plate for rapid installation

Moving end with bore  
(outer link) 03...1Z

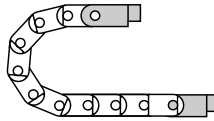

03...2Z Fixed end  
with pin (inner link)

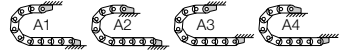

Possible installation conditions for assembled mounting brackets ▶ Order example "preassembled" below

03...1Z  
Moving end

03...2Z  
Fixed end

**Dimensions and order configurations**

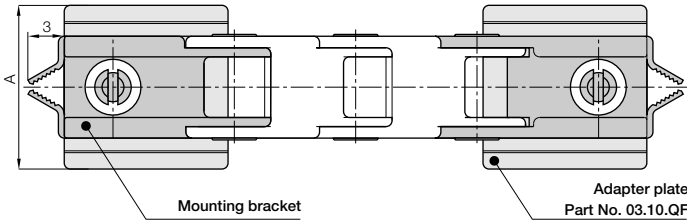

For E-Chain®	Part No. full set	Dim. A [mm]
E03.05. ▶	03.05. 12Z	8,7
E03.07. ▶	03.07. 12Z	10,7
E03.10. ▶	03.10. 12Z	13,7

For the **preassembled** mode please add the index **A1 ... A4** e.g. 03.05. 12Z **A1**

**Part No. structure**

03. 05. 12Z A1

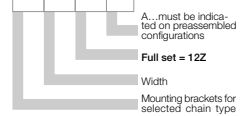

A... must be indicated on preassembled configurations  
Full set = 12Z  
Width  
Mounting brackets for selected chain type

**Full set, for both ends:**

03. 05. 12Z

**Single-part order:**

03. 05. 1Z

Mounting bracket **with bore**

03. 05. 2Z

Mounting bracket **with pin**

**03.10.QF = Adapter plate for all sizes**

The adapter has broken edges, so that it can be adapted to the respective chain width. It is not absolutely necessary for attaching the mounting brackets. The mounting brackets can also be screwed on without the adapter plate.

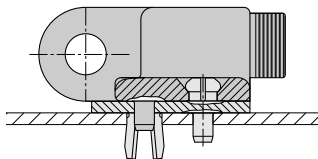

Adapter plate for rapid installation upon request Part No. 03.10.QF

**Additional Features**

Phone +49- (0) 22 03-96 49-800  
Fax +49- (0) 22 03-96 49-222





Price index



IPA Qualification Certificate:  
Air Cleanless Class ISO Class 2  
(at v = 1 m/s) upon request



UL94-V2  
classifications



Torsional  
motion possible



Special equipment:  
Electrically conductive ESD/ATEX  
version upon request



Just push the cables with your thumb  
into the E-Chain® - and it's ready



When to use the Series E04:

- If filling is required without opening and closing lids
- If price is an issue
- If quiet operation is required



When not to use it:

- For applications with very high loads and long unsupported travel lengths
  - ▶ Series 06 E2 micro, page 5.26
- If a E-Chain® is needed, which is not to open
  - ▶ Series 06 E2 micro, page 5.26

- ① Very easy to fill - ideal for harnessed cable assemblies
- ② Small pitch for low-noise, smooth operation
- ③ For high acceleration
- ④ Limited torsion tolerance
- ⑤ Cable -friendly smooth interior
- ⑥ Mounting brackets available
- ⑦ The patented push-button principle holds the links together



Special solution -  
opening gap 0,8 mm  
Part No. E04.07.015.S

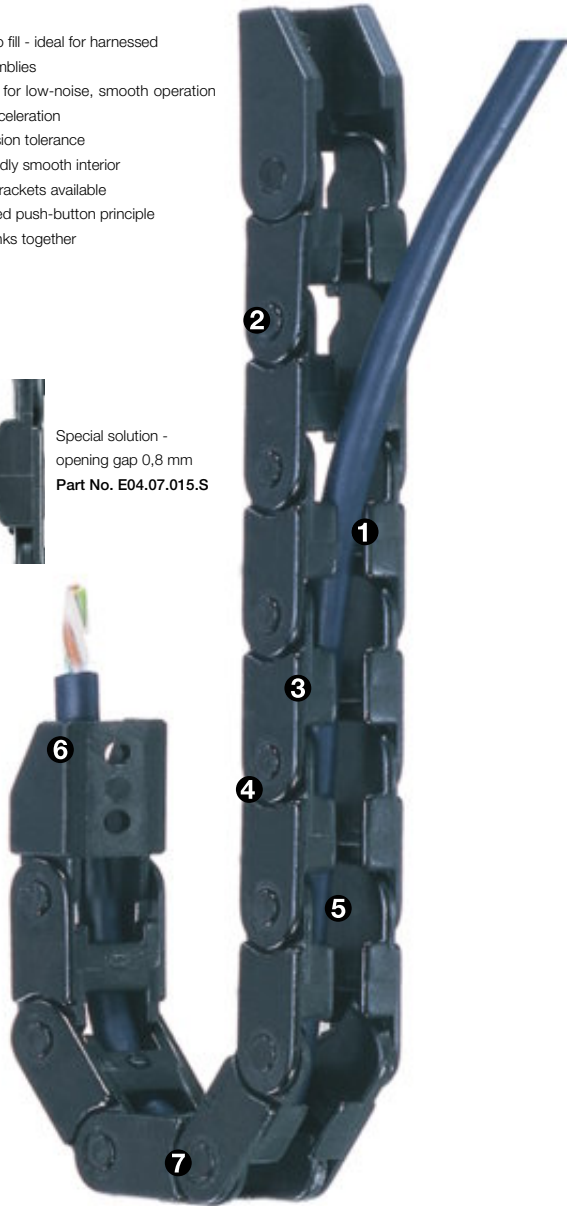

Order example complete E-Chain®

Please indicate chain-lengths or number of links Example: 1 m or 60 links

1 m E04.07.038.0



E-Chain®

1 set 040.07.12



Mounting bracket

**Unsupported length**

$FL_G$  = with straight upper run

$FL_B$  = with permitted sag

Further information ► **Design, page 1.12**

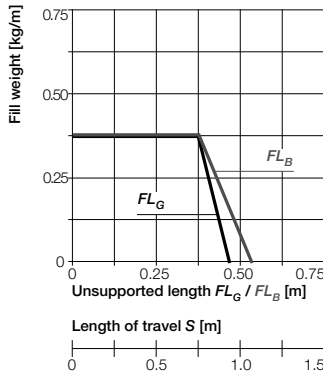
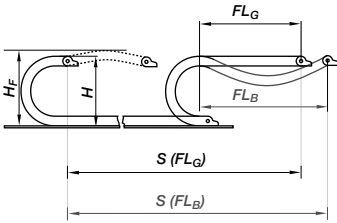

- $S$  = Length of travel
- $R$  = Bending radius
- $H$  = Nominal clearance height
- $H_F$  = Required clearance height
- $D$  = Overlength E-Chain® radius in final position
- $K = \pi \cdot R + \text{"safety"}$



Easy Chain®  
Inner height: 7 mm

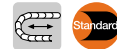
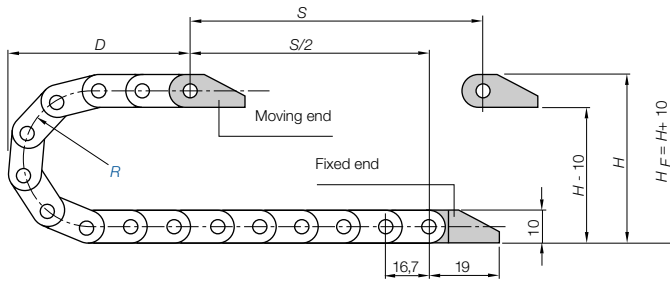

**Short travels - unsupported**

Unsupported E-Chains® feature positive camber over short travels. This must be accounted for when specifying the clearance height  $H_F$ . Please consult igus® if space is particularly restricted.

**Pitch = 16,7 mm/link    Links/m = 60 (1.002 mm)    Chain length =  $S/2 + K$**

R	015	018	028	038	048
H	42	48	68	88	108
D	37	40	50	60	70
K	80	90	125	155	185

The required clearance height:  
 **$H_F = H + 10$  mm**  
(with 0,1 kg/m fill weight)



Phone +49- (0) 22 03-96 49-800  
Fax +49- (0) 22 03-96 49-222

**Chainflex® CF98 - tested 30 million strokes with 4xd**

TPE outer jacket, oil- and bio-oil-resistant, PVC and halogen-free, low-temperature-flexible  
Further information: [www.igus.de/en/CF98](http://www.igus.de/en/CF98)



Speed / acceleration $FL_G$	max. 20 [m/s] / max. 200 [m/s²]
Speed / acceleration $FL_B$	max. 3 [m/s] / max. 6 [m/s²]
Gliding speed / acceleration (maximum)	max. 3 [m/s] / max. 10 [m/s²]
Material (E-Chain®)- permitted temperature °C	igumid NB / -30° up to +100° C
Material (mounting brackets)* - permitted temperature °C	igumid G / -40° up to +130° C
Flammability class (E-Chain®), igumid NB	VDE 0304 IIC UL94 V2
Flammability class (mounting brackets), igumid G*	VDE 0304 IIC UL94 HB

\*Available in igumid NB upon request, please consult igus® for delivery time

**Technical Data**



Details of material properties  
► page 1.38



► page 3.5



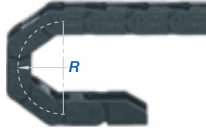
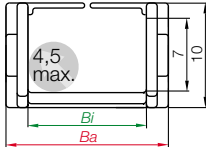

Part No. structure

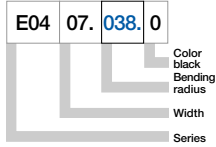

Series E04 - split crossbar along the outer radius

Part No.	Bi [mm]	Ba [mm]	R [mm]	Bending radii				Weight [kg/m]
E04.07.□.0	7	13	015	018	028	038	048	~ 0,08

Ba: pin dimension approx. 0,1 - 0,3 mm wider!

Supplement Part No. with required radius. Example: E04.07.038.0

0 = standard color, other colors ▶ page 1.39 · Pitch = 16,7 mm/link - Links/m = 60

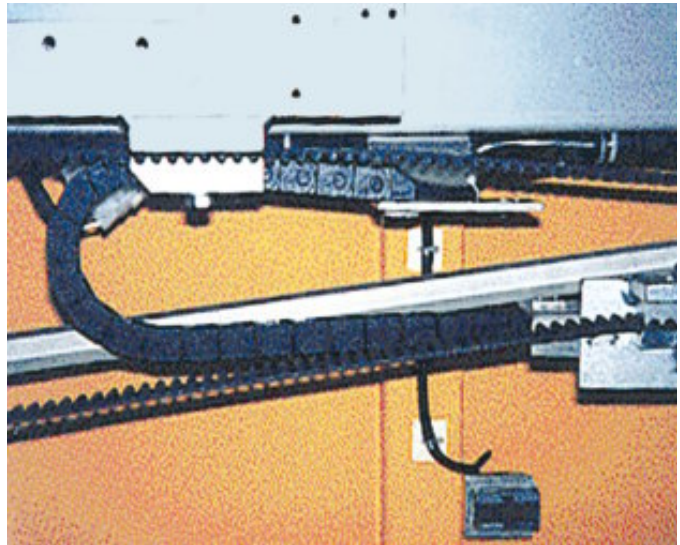

Easy Chain® fast substitution of cables also in applications with little space



**Polymer, one-piece**

- One-piece mounting bracket
- Corrosion-resistant
- Available preassembled

Moving end with bore  
(outer link) 040...1

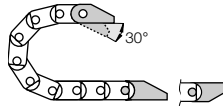

040...2 Fixed end  
with pin (inner link)

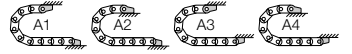

Possible installation conditions for assembled mounting brackets ▶ Order example "preassembled" below

040...1  
Moving end

040...2  
Fixed end

**Dimensions and order configurations**

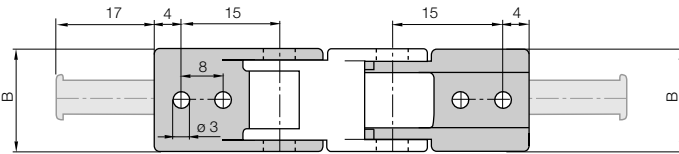

For	Part No.	Part No.	Number of teeth	Dim. B [mm]
E-Chain®	full set with tiewrap plate	full set without tiewrap plate		
E04.07. ▶	040.07. 12 PZ	040.07. 12 PZ	1	13

For the **preassembled** mode please add the index **A1 ... A4** e.g. 040.07. 12 PZ **A1**

**Part No. structure**

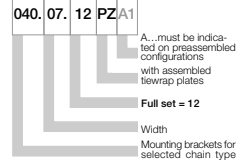

- Full set, for both ends:**  
 040.07. 12 PZ +tiewrap plate
- Single-part order:**  
 040.07. 1 PZ +tiewrap plate
- Mounting bracket **with bore**  
 040.07. 2 PZ +tiewrap plate
- Mounting bracket **with pin**

Phone +49- (0) 22 03-96 49-800  
 Fax +49- (0) 22 03-96 49-222



**Quicksnap** - the complete, detachable mounting unit, available upon request



**Quickfix** - mounting bracket with dowel, available upon request

**Additional Features**





Price index



IPA Qualification Certificate:  
Air Cleanless Class ISO Class 2  
(at v = 1 m/s) upon request



UL94-V2  
classifications



Torsional  
motion possible



Special equipment:  
Electrically conductive ESD/ATEX  
version upon request



Just push the cables with your thumb  
into the E-Chain® - and it's ready



When to use the Series E045/Z045:

- If filling is required without opening and closing lids
- If a very small pitch is required



When not to use it:

- For applications with very high loads and long unsupported travel lengths
  - ▶ Series 06 E2 micro, page 5.26
- If smooth operation is required
  - ▶ Series 045 E2 micro, page 5.18
- If high stability is required
  - ▶ Series 06 E2 micro, page 5.26

- ① Very easy to fill
- ② Small pitch for low-noise, smooth operation
- ③ Limited torsion tolerance
- ④ The patented push-button principle holds the links together
- ⑤ Cable-friendly interior
- ⑥ "E" Series features split crossbar along the outer radius
- ⑦ "Z" Series features split crossbar along the inner radius
- ⑧ Mounting bracket available
- ⑨ 1-, 2- or 3-chamber system available

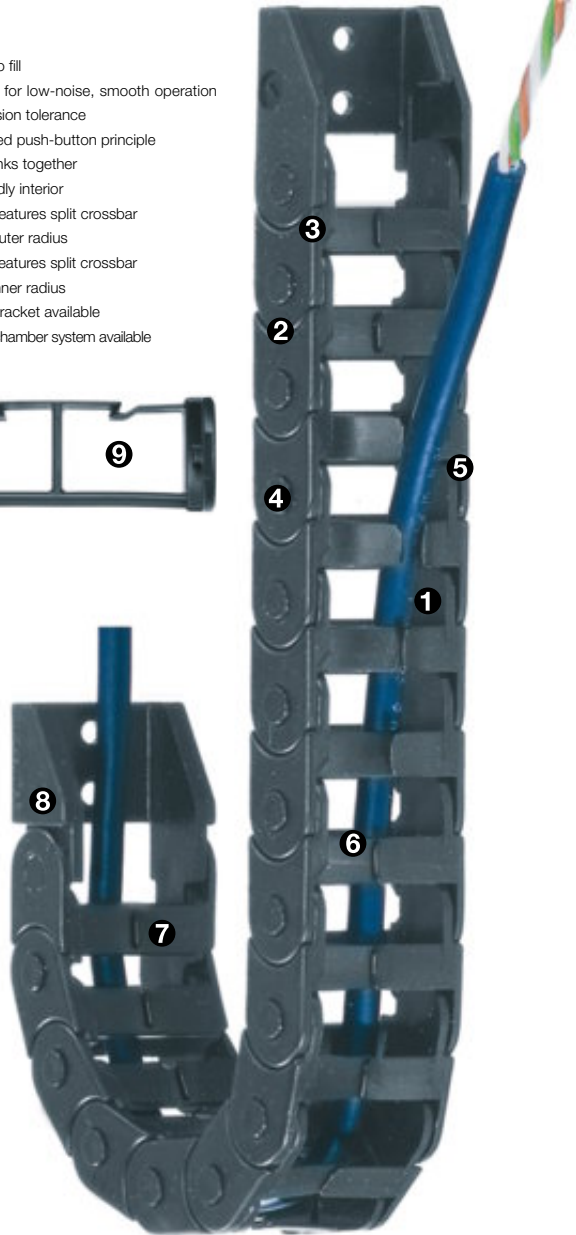

Order example complete E-Chain®

Please indicate chain-lengths or number of links Example: 1 m or 77 links

1 m E045.16.038.0



E-Chain®

1 set 0450.16.12



Mounting bracket

**Unsupported length**

$FL_G$  = with straight upper run

$FL_B$  = with permitted sag

Further information ► **Design, page 1.12**

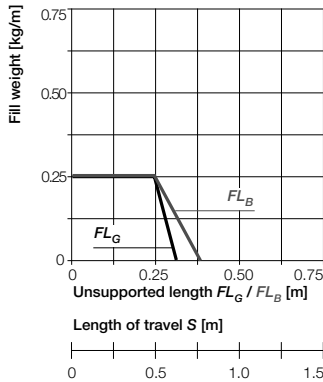
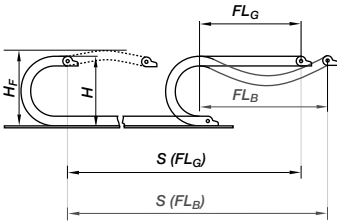

- $S$  = Length of travel
- $R$  = Bending radius
- $H$  = Nominal clearance height
- $H_F$  = Required clearance height
- $D$  = Overlength E-Chain® radius in final position
- $K = \pi \cdot R + \text{"safety"}$

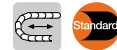
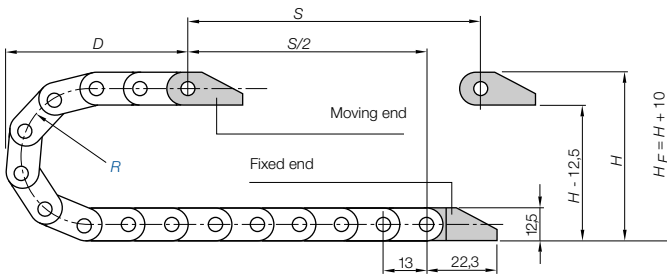

**Short travels - unsupported**

Unsupported E-Chains® feature positive camber over short travels. This must be accounted for when specifying the clearance height  $H_F$ . Please consult igus® if space is particularly restricted.

**Pitch = 13 mm/link   Links/m = 77 (1.001 mm)   Chain length =  $S/2 + K$**

R	018	028	038
H	50	70	90
D	40	50	60
K	95	120	145

The required clearance height:  
 **$H_F = H + 10$  mm**  
(with 0,1 kg/m fill weight)

9,4

Easy Chain®  
Inner height: 9,4 mm

Phone +49- (0) 22 03-96 49-800  
Fax +49- (0) 22 03-96 49-222



► page 3.5

Speed / acceleration $FL_G$	max. 20 [m/s] / max. 200 [m/s²]
Speed / acceleration $FL_B$	max. 3 [m/s] / max. 6 [m/s²]
Gliding speed / acceleration (maximum)	max. 3 [m/s] / max. 10 [m/s²]
Material (E-Chain®)- permitted temperature °C	igumid NB / -30° up to +100° C
Material (mounting brackets)* - permitted temperature °C	igumid G / -40° up to +130° C
Flammability class (E-Chain®), igumid NB	VDE 0304 IIC UL94 V2
Flammability class (mounting brackets), igumid G*	VDE 0304 IIC UL94 HB

\*Available in igumid NB upon request, please consult igus® for delivery time

**Technical Data**



**Details of material properties**  
► page 1.38

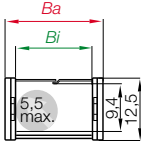

Series E045 - split crossbar along the outer radius

Part No.	Bi [mm]	Ba [mm]	R [mm] Bending radii	Weight [kg/m]
E045.10.□.0	10	17	018 028 038	≈ 0,09
E045.16.□.0	16	23	018 028 038	≈ 0,11

Ba: pin dimension approx. 0,1 - 0,3 mm wider!

Supplement Part No. with required radius. Example: E045.16.□.038.0

0 = standard color, other colors ▶ page 1.39 · Pitch = 13 mm/link - Links/m = 77

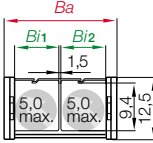

Series E045 - split crossbar along the outer radius with 2-chamber system

Part No.	Bi1/Bi2 [mm]	Ba [mm]	R [mm] Bending radii	Weight [kg/m]
E045.2/7.□.0	7 / 7	23	018 028 038	≈ 0,13
E045.2/9.□.0	9 / 9	27	018 028 038	≈ 0,14

Ba: pin dimension approx. 0,1 - 0,3 mm wider!

Supplement Part No. with required radius. Example: E045.2/9.20.□.038.0

0 = standard color, other colors ▶ page 1.39 · Pitch = 13 mm/link - Links/m = 77

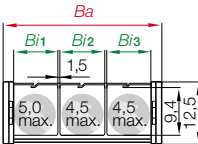

Series E045 - split crossbar along the outer radius with 3-chamber system

Part No.	Bi1/Bi2/Bi3 [mm]	Ba [mm]	R [mm] Bending radii	Weight [kg/m]
E045.3/9.□.0	9 / 9 / 9	37	018 028 038	≈ 0,17

Ba: pin dimension approx. 0,1 - 0,3 mm wider!

Supplement Part No. with required radius. Example: E045.3/9.20.□.038.0

0 = standard color, other colors ▶ page 1.39 · Pitch = 13 mm/link - Links/m = 77

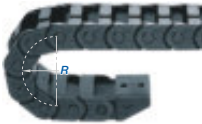

Part No. structure

E045. 16. 038. 0



Series Z045 - split crossbar along the inner radius

Part No.	$B_i$ [mm]	$B_a$ [mm]	$R$ [mm] Bending radii	Weight [kg/m]
Z045.16.□.0	16	23	018 028 038	≈ 0,11

$B_a$ : pin dimension approx. 0,1 - 0,3 mm wider!

Supplement Part No. with required radius. Example: Z045.16.038.0

0 = standard color, other colors ▶ page 1.39 · Pitch = 13 mm/link - Links/m = 77

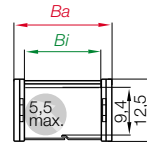

Series Z045 - split crossbar along the inner radius with 2-chamber system

Part No.	$B_i/B_i2$ [mm]	$B_a$ [mm]	$R$ [mm] Bending radii	Weight [kg/m]
Z045.2/7.□.0	7 / 7	23	018 028 038	≈ 0,13

$B_a$ : pin dimension approx. 0,1 - 0,3 mm wider!

Supplement Part No. with required radius. Example: Z045.2/7.20.038.0

0 = standard color, other colors ▶ page 1.39 · Pitch = 13 mm/link - Links/m = 77

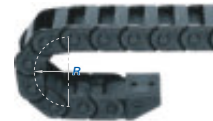
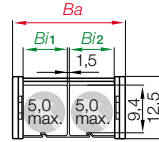

Part No. structure

Z045. 16. 038. 0

- Color black
- Bending radius
- Width
- Series

Easy Chain®  
Inner height: 9,4 mm

Phone +49- (0) 22 03-96 49-800  
Fax +49- (0) 22 03-96 49-222







**Polymer, one-piece**

- One-piece mounting bracket
- Corrosion-resistant
- Available preassembled

Moving end with bore  
(outer link) 045...1

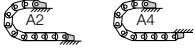
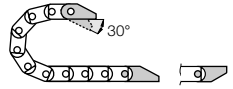

Possible installation conditions for assembled mounting brackets ► Order example "preassembled" below

045...2 E03...2Z Fixed end  
with pin (inner link)

**Dimensions and order configurations**

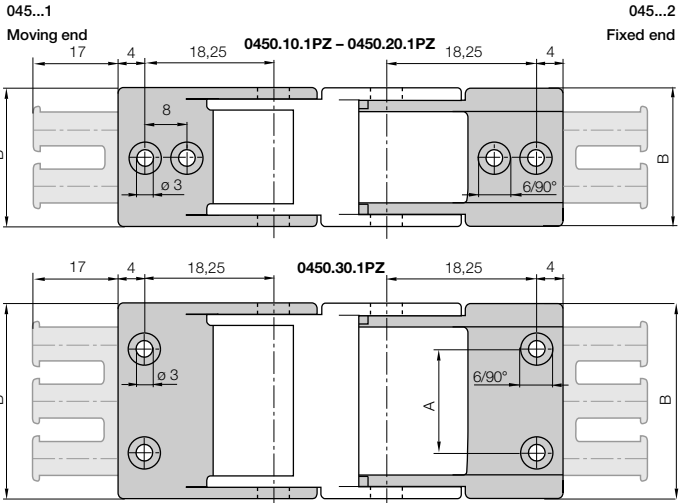

**Part No. structure**

0450. 10. 12 PZ A2

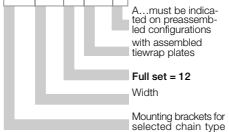

Full set, for both ends:

0450. 10. 12 PZ +tie-wrap plate

Single-part order:

0450. 10. 1 PZ +tie-wrap plate

Mounting bracket with bore

0450. 10. 2 PZ +tie-wrap plate

Mounting bracket with pin

For E-Chain®	Part No. full set with tie-wrap plate	Part No. full set without tie-wrap plate	Number of teeth	Dim. A [mm]	Dim. B [mm]
E045.10.	0450.10. 12 PZ	0450.10. 12	1	-	16
E/Z045.16.	0450.16. 12 PZ	0450.16. 12	2	-	22
EZ045.2/7.	0450.16. 12 PZ	0450.16. 12	2	-	22
E045.2/9.	0450.20. 12 PZ	0450.20. 12	2	-	26
E045.3/9.	0450.30. 12 PZ	0450.30. 12	3	22	36

For the preassembled mode please add the index A1...A4 e.g. 0450.20. 12 PZ A1

**Additional Features**



**Quicksnap** - the complete, detachable mounting unit, available upon request



**Quickfix** - mounting bracket with dowel, available upon request

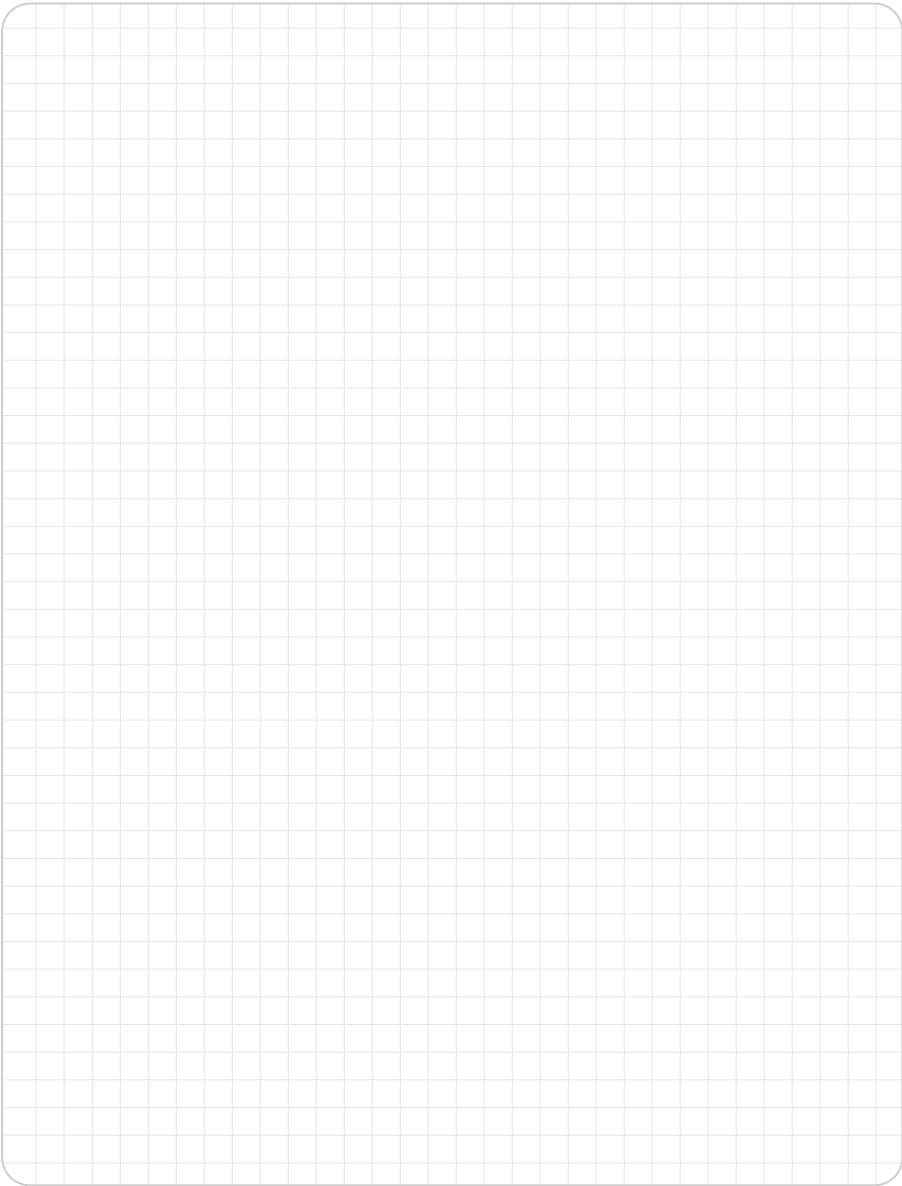

Easy Chain®  
Inner height: 9,4 mm

Phone +49- (0) 22 03-96 49-800  
Fax +49- (0) 22 03-96 49-222



## Chainflex® CF98 - tested 30 million strokes with 4xd

TPE outer jacket, oil- and bio-oil-resistant,  
PVC and halogen-free, low-temperature-flexible  
Further information: [www.igus.de/en/CF98](http://www.igus.de/en/CF98)



▶ page 3.5



Price index



IPA Qualification Certificate:  
Air Cleanless Class ISO Class 2  
(at v = 1 m/s) upon request



UL94-V2  
classifications



Torsional  
motion possible



Special equipment:  
Electrically conductive ESD/ATEX  
version upon request

- ① Very easy to fill - ideal for harnessed cable assemblies
- ② Small pitch for low-noise, smooth operation
- ③ Limited torsion tolerance
- ④ Very light weight
- ⑤ The patented push-button principle holds the links together
- ⑥ Cable -friendly smooth interior
- ⑦ "E" Series features split crossbar along the outer radius
- ⑧ "Z" Series features split crossbar along the inner radius
- ⑨ Integrated strain relief option



Special solution -  
opening gap 3,5 mm  
Part No. E06.10.018S3



Just push the cables with your thumb  
into the E-Chain® - and it's ready



When to use the Series E06/Z06:

- If filling is required without opening and closing lids
- If price is an issue
- If quiet operation is required



When not to use it:

- For applications with very high loads and long unsupported travel lengths
  - ▶ Series 06 E2 micro, page 5.26
- "Z" Series is unsuitable for gliding applications
  - ▶ Series 07 Zipper, page 4.10



Order example complete E-Chain®

Please indicate chain-lengths or number of links Example: 1 m or 50 links

1 m E06.10.038.0



E-Chain®

1 set 060.10.12



Mounting bracket

### Unsupported length

$FL_G$  = with straight upper run

$FL_B$  = with permitted sag

Further information ► Design, page 1.12

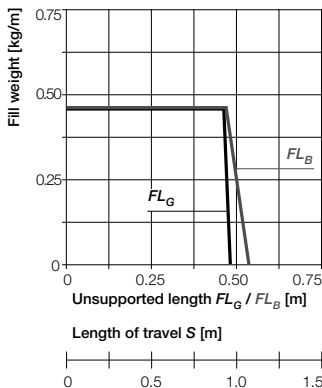
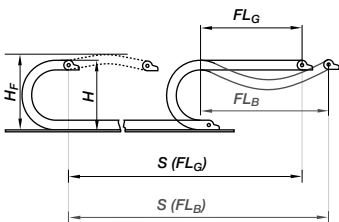

- $S$  = Length of travel
- $R$  = Bending radius
- $H$  = Nominal clearance height
- $H_F$  = Required clearance height
- $D$  = Overlength E-Chain® radius in final position
- $K = \pi \cdot R + \text{"safety"}$

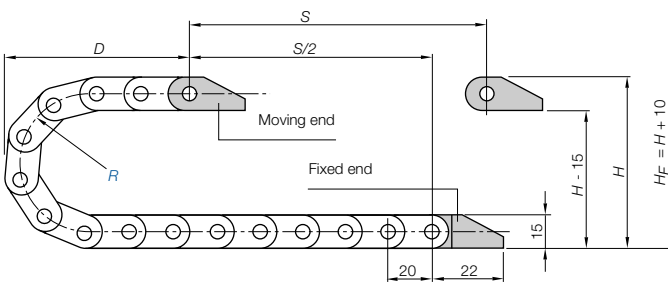

### Short travels - unsupported

Unsupported E-Chains® feature positive camber over short travels. This must be accounted for when specifying the clearance height  $H_F$ . Please consult igus® if space is particularly restricted.

Pitch = 20 mm/link    Links/m = 50 (1.000 mm)    Chain length =  $S/2 + K$

R	018	028	038
H	52	70	90
D	40	50	60
K	95	120	145

The required clearance height:  
 $H_F = H + 10$  mm  
 (with 0,2 kg/m fill weight)

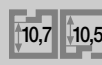

Easy Chain®  
Inner height: 10,7/10,5 mm

Phone +49- (0) 22 03-96 49-800  
Fax +49- (0) 22 03-96 49-222



Speed / acceleration $FL_G$	max. 20 [m/s] / max. 200 [m/s²]
Speed / acceleration $FL_B$	max. 3 [m/s] / max. 6 [m/s²]
Gliding speed / acceleration (maximum)	max. 3 [m/s] / max. 10 [m/s²]
Material (E-Chain®)- permitted temperature °C	igumid NB / -30° up to +100° C
Material (mounting brackets)* - permitted temperature °C	igumid G / -40° up to +130° C
Flammability class (E-Chain®), igumid NB	VDE 0304 IIC UL94 V2
Flammability class (mounting brackets), igumid G*	VDE 0304 IIC UL94 HB

\*Available in igumid NB upon request, please consult igus® for delivery time

### Technical Data



Details of material properties  
 ► page 1.38



► page 3.5

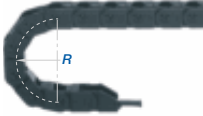
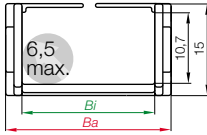

Part No. structure

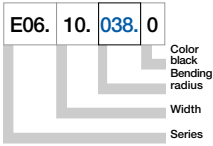

Series E06 - split crossbar along the outer radius

Part No.	Bi [mm]	Ba [mm]	R [mm]	Bending radii			Weight [kg/m]
E06.10.□.0	10	16,5	018	028	038	≈ 0,14	
E06.16.□.0	16	22,5	018	028	038	≈ 0,16	

Ba: pin dimension approx. 0,2 - 0,4 mm wider!

Supplement Part No. with required radius. Example: E06.10.038.0

0 = standard color, other colors ▶ page 1.39 · Pitch = 20 mm/link - Links/m = 50

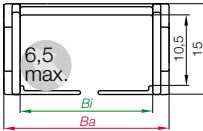

Part No. structure

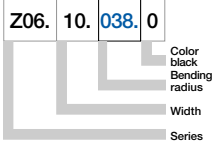

Series Z06 - split crossbar along the inner radius

Part No.	Bi [mm]	Ba [mm]	R [mm]	Bending radii			Weight [kg/m]
Z06.10.□.0	10	16,5	018	028	038	≈ 0,14	
Z06.16.□.0	16	22,5	018	028	038	≈ 0,16	

Ba: pin dimension approx. 0,2 - 0,4 mm wider!

Supplement Part No. with required radius. Example: Z06.10.038.0

0 = standard color, other colors ▶ page 1.39 · Pitch = 20 mm/link - Links/m = 50





**Polymer, one-piece**

- One-piece mounting bracket
- Corrosion-resistant
- Available preassembled
- Inner and outer attachment possible
- Available with integrated strain relief tiwrap plates

Moving end with bore  
(outer link) 060...1(PZ)

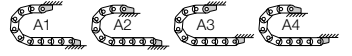
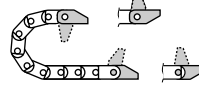

060...2(PZ) Fixed end  
with pin (inner link)

Possible installation conditions for assembled mounting brackets ▶ Order example "preassembled" below

060...1(PZ)  
Moving end

060...2(PZ)  
Fixed end

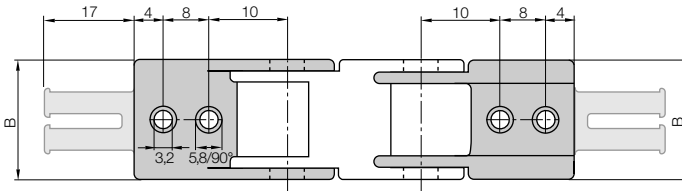

**Dimensions and order configurations**

Strain relief is possible on the moving end and/or the fixed end.

**Part No. structure**

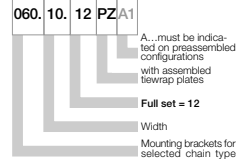

**Full set, for both ends:**

060.10.12.PZ +tiwrap plate

**Single-part order:**

060.10.1.PZ +tiwrap plate

Mounting bracket with bore

060.10.2.PZ +tiwrap plate

Mounting bracket with pin

For	Part No. full set with tiwrap plate	Part No. full set without tiwrap plate	Number of teeth	Dim. B [mm]
E-Chain®				
E06-Z06.10. ▶	060.10.12.PZ	060.10.12	1	16,5
E06-Z06.16. ▶	060.16.12.PZ	060.16.12	2	22,5

For the preassembled mode please add the index A1 ... A4 e.g. 060.10.12.PZA1



**Quicksnap** - the complete, detachable mounting unit, available upon request



**Quickfix** - mounting bracket with dowel, available upon request

**Additional Features**

Phone +49- (0) 22 03-96 49-800  
Fax +49- (0) 22 03-96 49-222







Price index



IPA Qualification Certificate:  
Air Cleanless Class ISO Class 2  
(at v = 1 m/s) upon request



UL94-V2  
classifications



Torsional  
motion possible



Special equipment:  
Electrically conductive ESD/ATEX  
version upon request



Just push the cables with your thumb  
into the E-Chain® - and it's ready



When to use the Series E065:

- if filling is required without opening and closing lids
- if price is an issue
- if quiet operation is required



When not to use it:

- for applications with very high loads and long unsupported travel lengths
- Series 06 E2 micro, page 5.26

- 1 Very easy to fill - ideal for harnessed cable assemblies
- 2 Small pitch for low-noise, smooth operation
- 3 Limited torsion tolerance
- 4 Very light weight
- 5 The patented push-button principle holds the links together
- 6 Cable-friendly interior
- 7 Split crossbar along the outer radius
- 8 Bunting bracket with integrated strain relief
- 9 1, 2- or 4-chamber system available

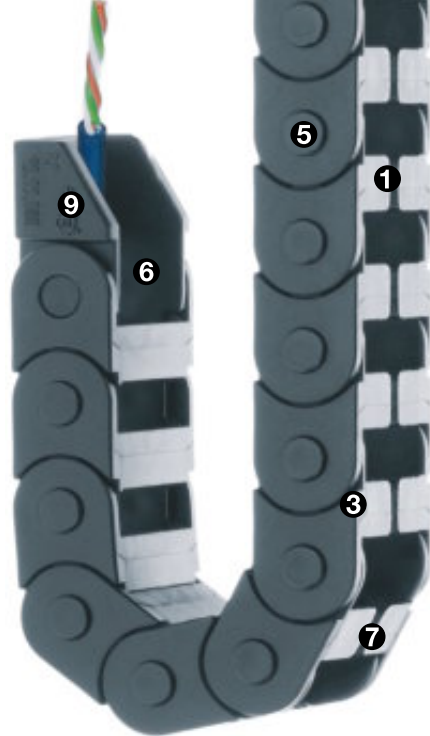

Order example complete E-Chain®

Release indicate chain-lengths or number of links Example: 1 m or 67 links

1m E065.10.038.0



E-Chain®

1set 0650.10.12



Mounting bracket

**Unsupported length**

$FL_G$  = with straight upper run

$FL_B$  = with permitted sag

Further information ► **Design, page 1.12**

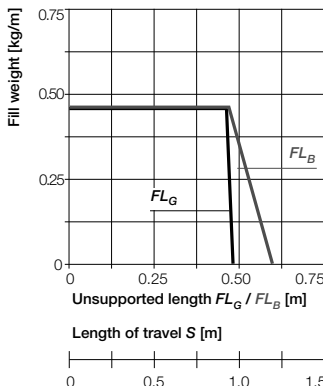
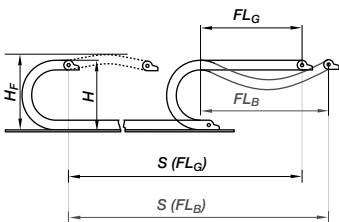

- $S$  = Length of travel
- $R$  = Bending radius
- $H$  = Nominal clearance height
- $H_F$  = Required clearance height
- $D$  = Overlength E-Chain® radius in final position
- $K = \pi \cdot R + \text{"safety"}$

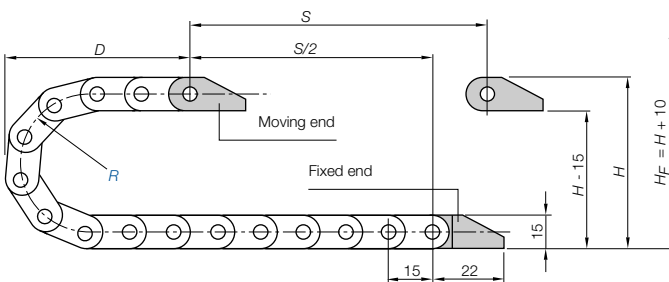

**Short travels - unsupported**

Unsupported E-Chains® feature positive camber over short travels. This must be accounted for when specifying the clearance height  $H_F$ . Please consult igus® if space is particularly restricted.

**Pitch = 15 mm/Glided Links/m = 67 (1.005 mm) Chain length =  $S/2 + K$**

$R$	018	028	038
$H$	52	70	90
$D$	40	50	60
$K$	86	118	149

The required clearance height:  
 $H_F = H + 10$  mm  
 (with 0,2 kg/m fill weight)

Speed / acceleration $FL_G$	max. 20 [m/s] / max. 200 [m/s²]
Speed / acceleration $FL_B$	max. 3 [m/s] / max. 6 [m/s²]
Gliding speed / acceleration (maximum)	max. 3 [m/s] / max. 10 [m/s²]
Material (E-Chain®)- permitted temperature °C	igumid NB / -30° up to +100° C
Material (mounting brackets)* - permitted temperature °C	igumid G / -40° up to +130° C
Flammability class (E-Chain®), igumid NB	VDE 0304 IIC UL94 V2
Flammability class (mounting brackets), igumid G*	VDE 0304 IIC UL94 HB

\*Available in igumid NB upon request, please consult igus® for delivery time

**Technical Data**



Details of material properties  
 ► page 1.38



Easy Chain®  
 Inner height: 11,3 mm

Phone +49- (0) 22 03-96 49-800  
 Fax +49- (0) 22 03-96 49-222



► page 3.5

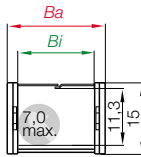

## Series E065 - split crossbar along the outer radius

Part No.	Bi [mm]	Ba [mm]	R [mm] Bending radii	Weight [kg/m]
E065.16.□.0	16	24,8	018 028 038	~ 0,17

Supplement Part No. with required radius. Example: E065.16.038.0

0 = standard color, other colors ► page 1.39 · Pitch = 15 mm/link - Links/m = 67

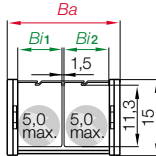

## Series E065 - split crossbar along the outer radius with 2-chamber system

Part No.	Bi1/Bi2 [mm]	Ba [mm]	R [mm] Bending radii	Weight [kg/m]
E065.2/9.□.0	9 / 9	29,3	018 028 038	~ 0,19

Supplement Part No. with required radius. Example: E065.2/9.20.038.0

0 = standard color, other colors ► page 1.39 · Pitch = 15 mm/link - Links/m = 67

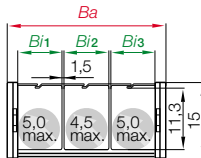

## Series E065 - split crossbar along the outer radius with 3-chamber system

Part No.	Bi1/Bi2/Bi3 [mm]	Ba [mm]	R [mm] Bending radii	Weight [kg/m]
E065.3/9.□.0	9 / 9 / 9	39,3	018 028 038	~ 0,22

Supplement Part No. with required radius. Example: E065.3/9.20.038.0

0 = standard color, other colors ► page 1.39 · Pitch = 15 mm/link - Links/m = 67

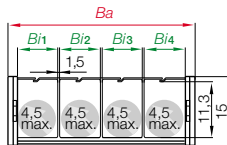

## Series E065 - split crossbar along the outer radius with 4-chamber system

Part No.	Bi1/Bi2/Bi3 [mm]	Ba [mm]	R [mm] Bending radii	Weight [kg/m]
E065.4/9.□.0	9 / 9 / 9 / 9	49,3	018 028 038	~ 0,25

Supplement Part No. with required radius. Example: E065.4/9.20.038.0

0 = standard color, other colors ► page 1.39 · Pitch = 15 mm/link - Links/m = 67

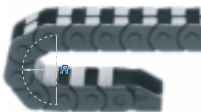

Part No. structure

E065. 16. 038. 0





**Polymer, one-piece**

- One-piece mounting bracket
- Corrosion-resistant
- Available preassembled
- Inner and outer attachment possible
- Available with integrated strain relief tiwrap plates

Moving end with bore  
(outer link) 065...1(PZ)

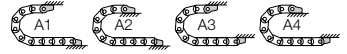
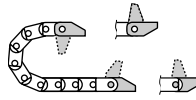

065...2(PZ) Fixed end  
with pin (inner link)

Possible installation conditions for assembled mounting brackets ▶ Order example "preassembled" below

065...1(PZ)  
Moving end

065...2(PZ)  
Fixed end

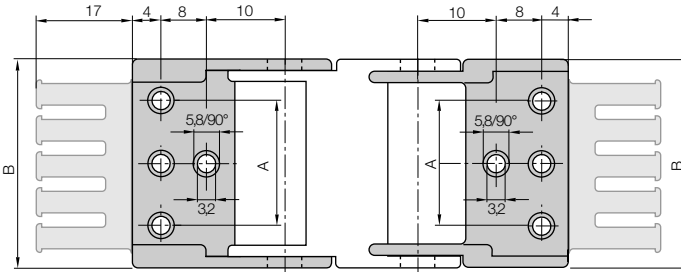

**Dimensions and order configurations**

Strain relief is possible on the moving end and/or the fixed end.

For E-Chain®	Part No. full set with tiwrap plate	Part No. full set without tiwrap plate	Number of teeth	Dim. A [mm]	Dim. B [mm]
E065.10. ▶	0650.10. 12 PZ	0650.10. 12	1	-	16,5
E065.16. ▶	0650.16. 12 PZ	0650.16. 12	2	-	22,5
E065.2/9. ▶	0650.2/9. 12 PZ	0650.2/9. 12	2	-	27
E065.3/9. ▶	0650.3/9. 12 PZ	0650.3/9. 12	3	22	37
E065.4/9. ▶	0650.4/9. 12 PZ	0650.4/9. 12	4	32	47

**Part No. structure**

0650. 10. 12 PZ A1

A... must be indicated on preassembled configurations with assembled tiwrap plates  
Full set = 12  
Width  
Mounting brackets for selected chain type

**Full set, for both ends:**

0650. 10. 12 PZ +tiwrap plate

**Single-part order:**

0650. 10. 1 PZ +tiwrap plate

Mounting bracket with bore

0650. 10. 2 PZ +tiwrap plate

Mounting bracket with pin

For the preassembled mode please add the index A1...A4 e. g. 0650.10. 12 PZ A1



**Quicksnap** - the complete, detachable mounting unit, available upon request



**Quickfix** - mounting bracket with dowel, available upon request

**Additional Features**



Tel. +49- (0) 22 03-96 49-800  
Fax +49- (0) 22 03-96 49-222



Price index



IPA Qualification Certificate:  
Air Cleanless Class ISO Class 2  
(at v = 1 m/s) upon request



UL94-V2  
classifications



Torsional  
motion possible



Special equipment:  
Electrically conductive ESD/ATEX  
version upon request

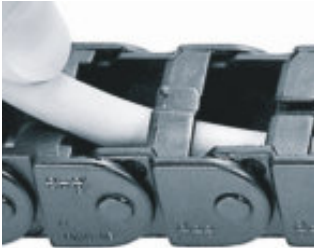

Just pull out cable by hand  
- and it's ready



When to use the Series E08/Z08:

- If filling is required without opening and closing lids
- If price is an issue
- If quiet operation is required



When not to use it:

- For applications with very high loads and long unsupported travel lengths
  - ▶ Series 09 Zipper, page 4.14
- "Z" Series is unsuitable for gliding applications
  - ▶ Series 09 Zipper, page 4.14

- 1 Very easy to fill - ideal for harnessed cable assemblies
- 2 Small pitch for low-noise, smooth operation
- 3 Limited torsion tolerance
- 4 Light Weight
- 5 The patented push-button principle holds the links together
- 6 Cable-friendly interior
- 7 "E" Series features split crossbar along the outer radius
- 8 "Z" Series features split crossbar along the inner radius
- 9 Integrated strain relief option



Order example complete E-Chain®

Please indicate chain-lengths or number of links Example: 1 m or 50 links

1 m E08.30.038.0



E-Chain®

1 set 080.30.12PZ



Mounting bracket

**Unsupported length**

$FL_G$  = with straight upper run

$FL_B$  = with permitted sag

Further information ► **Design, page 1.12**

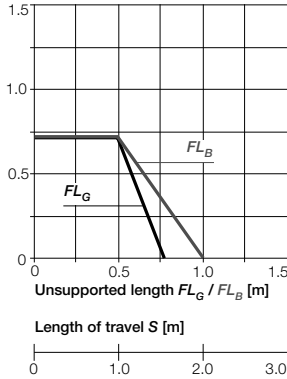
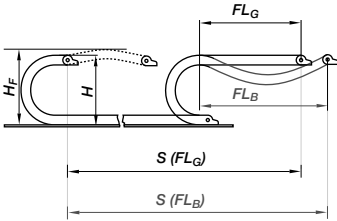

- $S$  = Length of travel
- $R$  = Bending radius
- $H$  = Nominal clearance height
- $H_F$  = Required clearance height
- $D$  = Overlength E-Chain® radius in final position
- $K = \pi \cdot R + \text{"safety"}$

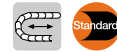
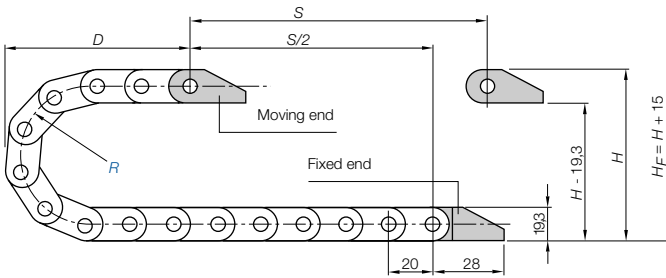

**Short travels - unsupported**

Unsupported E-Chains® feature positive camber over short travels. This must be accounted for when specifying the clearance height  $H_F$ . Please consult igus® if space is particularly restricted.

**Pitch = 20 mm/link    Links/m = 50 (1.000 mm)    Chain length =  $S/2 + K$**

R	028	038	048
H	76	96	116
D	60	70	80
K	130	160	190

The required clearance height:  
 $H_F = H + 15 \text{ mm}$   
 (with 0,3 kg/m fill weight)



Easy Chain®  
Inner height: 14,6/14,7 mm

Phone +49- (0) 22 03-96 49-800  
Fax +49- (0) 22 03-96 49-222



Speed / acceleration $FL_G$	max. 20 [m/s] / max. 200 [m/s²]
Speed / acceleration $FL_B$	max. 3 [m/s] / max. 6 [m/s²]
Gliding speed / acceleration (maximum)	max. 3 [m/s] / max. 10 [m/s²]
Material (E-Chain®) - permitted temperature °C	igumid NB / -30° up to +100° C
Material (mounting brackets)* - permitted temperature °C	igumid G / -40° up to +130° C
Flammability class (E-Chain®), igumid NB	VDE 0304 IIC UL94 V2
Flammability class (mounting brackets), igumid G*	VDE 0304 IIC UL94 HB

\*Available in igumid NB upon request, please consult igus® for delivery time

**Technical Data**



Details of material properties  
 ► page 1.38



► page 3.5



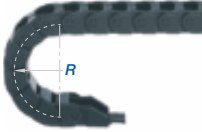
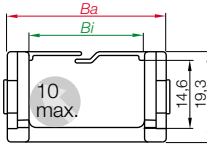

Part No. structure

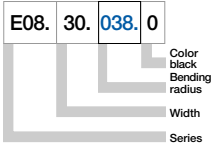

Series E08 - split crossbar along the outer radius

Part No.	Bi [mm]	Ba [mm]	R [mm]	Bending radii			Weight [kg/m]
E08.10.□.0	10	18,2	028	038	048	≈ 0,21	
E08.16.□.0	16	24,2	028	038	048	≈ 0,24	
E08.20.□.0	20	28,2	028	038	048	≈ 0,25	
E08.30.□.0	30	38,2	028	038	048	≈ 0,28	
E08.40.□.0	40	48,2	028	038	048	≈ 0,31	
E08.50.□.0	50	58,2	028	038	048	≈ 0,37	

Ba: pin dimension approx. 0,3 - 0,5 mm wider!

Supplement Part No. with required radius. Example: E08.30.□038□.0

0 = standard color, other colors ▶ page 1.39 · Pitch = 20 mm/link - Links/m = 50

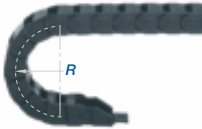
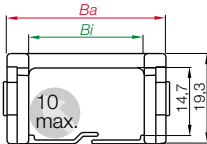

Part No. structure

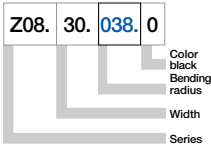

Series Z08 - split crossbar along the inner radius

Part No.	Bi [mm]	Ba [mm]	R [mm]	Bending radii			Weight [kg/m]
Z08.10.□.0	10	18,2	028	038	048	≈ 0,21	
Z08.16.□.0	16	24,2	028	038	048	≈ 0,24	
Z08.20.□.0	20	28,2	028	038	048	≈ 0,25	
Z08.30.□.0	30	38,2	028	038	048	≈ 0,28	
Z08.40.□.0	40	48,2	028	038	048	≈ 0,31	
Z08.50.□.0	50	58,2	028	038	048	≈ 0,37	

Ba: pin dimension approx. 0,3 - 0,5 mm wider!

Supplement Part No. with required radius. Example: Z08.30.□038□.0

0 = standard color, other colors ▶ page 1.39 · Pitch = 20 mm/link - Links/m = 50





**Polymer, one-piece**

- One-piece mounting bracket
- Corrosion-resistant
- Available preassembled
- Inner and outer attachment possible
- Available with integrated strain relief tiwrap plates

Moving end with bore  
(outer link) 080...1(PZ)

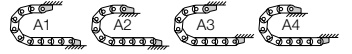
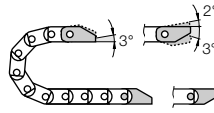

080...2(PZ) Fixed end  
with pin (inner link)

Possible installation conditions for assembled mounting brackets ▶ Order example "preassembled" below

080...1(PZ)  
Moving end

080...2(PZ)  
Fixed end

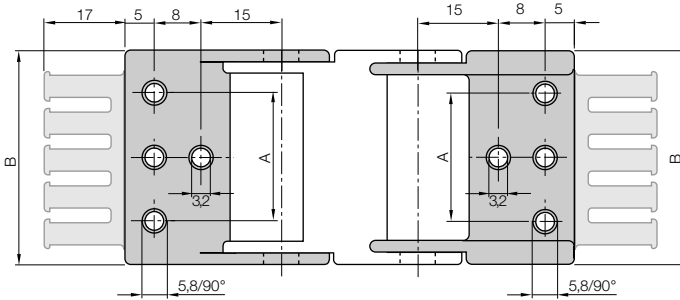

**Dimensions and order configurations**

Strain relief is possible on the moving end and/or the fixed end.

080.10.12 - 080.20.12: center bores only  
080.30.12 - 080.50.12: all bores

For E-Chain®	Part No. full set with tiwrap plate	Part No. full set without tiwrap plate	Number of teeth	Dim. A [mm]	Dim. B [mm]
E08-Z08.10. ▶	080.10.12 PZ	080.10.12	1	-	18,2
E08-Z08.16. ▶	080.16.12 PZ	080.16.12	2	-	24,2
E08-Z08.20. ▶	080.20.12 PZ	080.20.12	2	-	28,2
E08-Z08.30. ▶	080.30.12 PZ	080.30.12	3	22	38,2
E08-Z08.40. ▶	080.40.12 PZ	080.40.12	4	32	48,2
E08-Z08.50. ▶	080.50.12 PZ	080.50.12	5	42	58,2

For the preassembled mode please add the index A1 ... A4 e.g. 080.10.12 PZ A1

**Part No. structure**

080. 10. 12 PZ A1

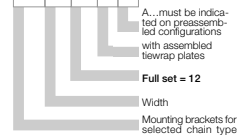

A... must be indicated on preassembled configurations with assembled tiwrap plates

Full set = 12

Width

Mounting brackets for selected chain type

**Full set, for both ends:**

080.10.12 PZ +tiwrap plate

**Single-part order:**

080.10.1 PZ +tiwrap plate

Mounting bracket with bore

080.10.2 PZ +tiwrap plate

Mounting bracket with pin

Phone +49- (0) 22 03-96 49-800  
Fax +49- (0) 22 03-96 49-222



**Quicksnap** - the complete, detachable mounting unit, available upon request



**Quickfix** - mounting bracket with dowel, available upon request

**Additional Features**



Price index



IPA Qualification Certificate:  
Air Cleanless Class ISO Class 2  
(at v = 1 m/s) upon request



UL94-V2  
classifications



Torsional  
motion possible



IPA Qualification Certificate: ESD  
Classification Level 1 (for Series  
E14.3.038). Special equipment:  
Electrically conductive ESD/ATEX  
version upon request

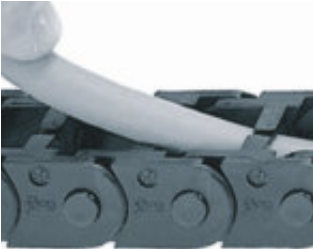

Just push the cables with your thumb  
into the E-Chain® - and it's ready



When to use the Series E14/Z14:

- If filling is required without opening and closing lids
- If price is an issue
- If quiet operation is required



When not to use it:

- For applications with very high loads and long unsupported travel lengths
  - ▶ Series B15 E2 mini, page 5.62
- "Z" Series is unsuitable for gliding applications
  - ▶ Series B15 E2 mini, page 5.62

- ① Limited torsion tolerance
- ② Very easy to fill - ideal for harnessed cable assemblies
- ③ The patented push-button principle holds the links together
- ④ Small pitch for low-noise, smooth operation
- ⑤ Cable-friendly interior
- ⑥ "E" Series features split crossbar along the outer radius
- ⑦ "Z" Series features split crossbar along the inner radius
- ⑧ Integrated strain relief option

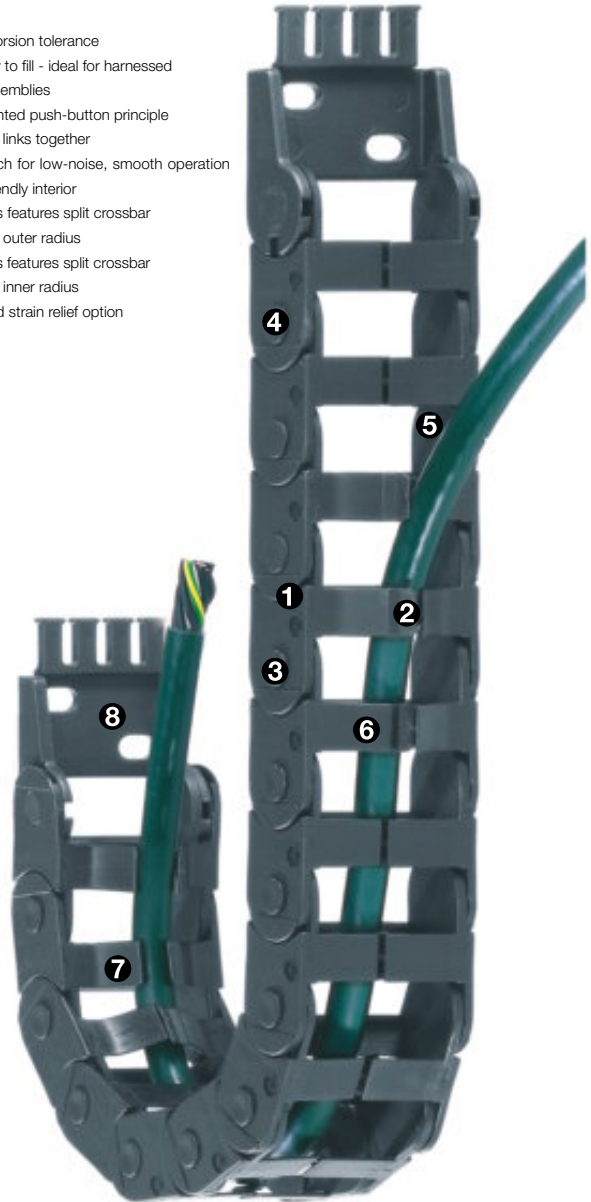

Order example complete E-Chain®

Please indicate chain-lengths or number of links Example: 1 m or 33 links

1 m E14.3.038.0



E-Chain®

1 set 114.3.12PZ



Mounting bracket

**Unsupported length**

$FL_G$  = with straight upper run

$FL_B$  = with permitted sag

Further information ► **Design, page 1.12**

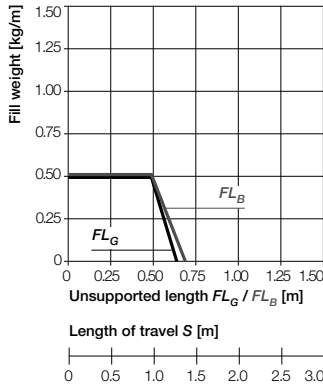
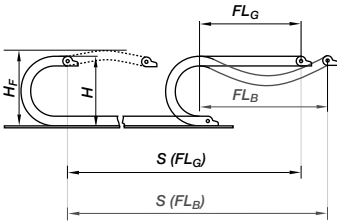

- $S$  = Length of travel
- $R$  = Bending radius
- $H$  = Nominal clearance height
- $H_F$  = Required clearance height
- $D$  = Overlength E-Chain® radius in final position
- $K = \pi \cdot R + \text{"safety"}$

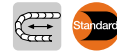
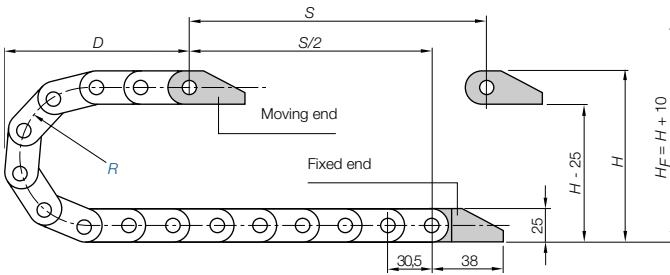

**Short travels - unsupported**

Unsupported E-Chains® feature positive camber over short travels. This must be accounted for when specifying the clearance height  $H_F$ . Please consult igus® if space is particularly restricted.

**Pitch = 30,5 mm/link Links/m = 33 (1.006,5 mm) Chain length =  $S/2 + K$**

$R$	028	038	048	075	100	125
$H$	82	102	122	177	227	277
$D$	71	81	91	120	145	170
$K$	150	185	215	300	375	455

The required clearance height:  
 **$H_F = H + 10$  mm**  
(with 0,2 kg/m fill weight)

**Low cost shielded PVC-control cable for medium load requirements - Chainflex® CF140.UL**

TIP!

UL, flame-retardant

Further information: [www.igus.de/en/CF140UL](http://www.igus.de/en/CF140UL)

CHAINFLEX® CF140.UL



Speed / acceleration $FL_G$	max. 20 [m/s] / max. 200 [m/s²]
Speed / acceleration $FL_B$	max. 3 [m/s] / max. 6 [m/s²]
Gliding speed / acceleration (maximum)	max. 3 [m/s] / max. 10 [m/s²]
Material (E-Chain®)- permitted temperature °C	igumid NB / -30° up to +100° C
Material (mounting brackets)* - permitted temperature °C	igumid G / -40° up to +130° C
Flammability class (E-Chain®), igumid NB	VDE 0304 IIC UL94 V2
Flammability class (mounting brackets), igumid G*	VDE 0304 IIC UL94 HB

\*Available in igumid NB upon request, please consult igus® for delivery time

**Technical Data**



Details of material properties  
► page 1.38



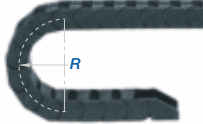
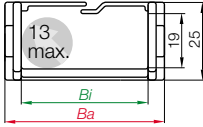

Part No. structure

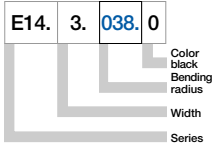

Series E14 - split crossbar along the outer radius

Part No.	Bi [mm]	Ba [mm]	R [mm]	Bending radii					Weight [kg/m]
E14.1. <input type="text"/> .0	15	27	<input type="text"/> 028	<input type="text"/> 038	<input type="text"/> 048	<input type="text"/> 075	<input type="text"/> 100	<input type="text"/> 125	≈ 0,31
E14.2. <input type="text"/> .0	25	37	<input type="text"/> 028	<input type="text"/> 038	<input type="text"/> 048	<input type="text"/> 075	<input type="text"/> 100	<input type="text"/> 125	≈ 0,32
E14.3. <input type="text"/> .0	38	50	<input type="text"/> 028	<input type="text"/> 038	<input type="text"/> 048	<input type="text"/> 075	<input type="text"/> 100	<input type="text"/> 125	≈ 0,40
E14.4. <input type="text"/> .0	50	62	<input type="text"/> 028	<input type="text"/> 038	<input type="text"/> 048	<input type="text"/> 075	<input type="text"/> 100	<input type="text"/> 125	≈ 0,44

Ba: pin dimension approx. 0,3 - 0,5 mm wider!

Supplement Part No. with required radius. Example: E14.3.  038 .0

0 = standard color, other colors ▶ page 1.39 · Pitch = 30,5 mm/link - Links/m = 33

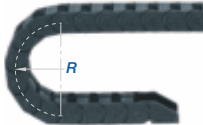
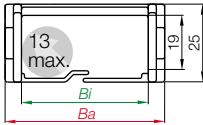

Part No. structure

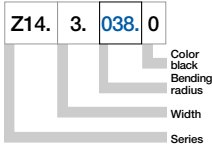

Series Z14 - split crossbar along the inner radius

Part No.	Bi [mm]	Ba [mm]	R [mm]	Bending radii					Weight [kg/m]
Z14.1. <input type="text"/> .0	15	27	<input type="text"/> 028	<input type="text"/> 038	<input type="text"/> 048	<input type="text"/> 075	<input type="text"/> 100	<input type="text"/> 125	≈ 0,31
Z14.2. <input type="text"/> .0	25	37	<input type="text"/> 028	<input type="text"/> 038	<input type="text"/> 048	<input type="text"/> 075	<input type="text"/> 100	<input type="text"/> 125	≈ 0,32
Z14.3. <input type="text"/> .0	38	50	<input type="text"/> 028	<input type="text"/> 038	<input type="text"/> 048	<input type="text"/> 075	<input type="text"/> 100	<input type="text"/> 125	≈ 0,40
Z14.4. <input type="text"/> .0	50	62	<input type="text"/> 028	<input type="text"/> 038	<input type="text"/> 048	<input type="text"/> 075	<input type="text"/> 100	<input type="text"/> 125	≈ 0,44

Ba: pin dimension approx. 0,3 - 0,5 mm wider!

Supplement Part No. with required radius. Example: Z14.3.  038 .0

0 = standard color, other colors ▶ page 1.39 · Pitch = 30,5 mm/link - Links/m = 33





**Polymer, one-piece**

- One-piece mounting bracket
- Corrosion-resistant
- Available preassembled
- Inner and outer attachment possible
- Available with integrated strain relief tiwrap plates

Moving end with bore  
(outer link) 114...1P(Z)

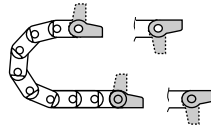

114...2P(Z) Fixed end  
with pin (inner link)



Possible installation conditions for assembled mounting brackets ► Order example "preassembled" below

114...1P(Z)  
Moving end

114...2P(Z)  
Fixed end

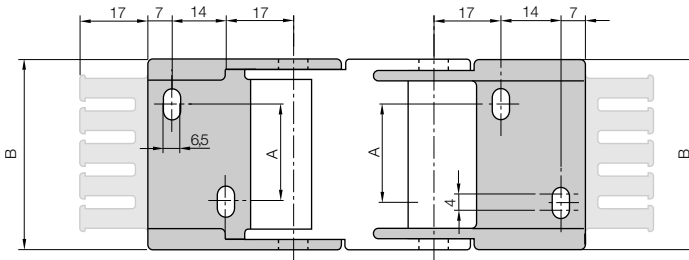

**Dimensions and order configurations**

Strain relief is possible on the moving end and/or the fixed end.

**Part No. structure**

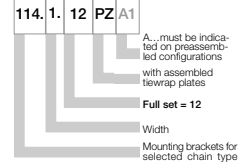

**Full set, for both ends:**

114. 1. 12 PZ +tiwrap plate

**Single-part order:**

114. 1. 1 PZ +tiwrap plate

Mounting bracket **with bore**

114. 1. 2 PZ +tiwrap plate

Mounting bracket **with pin**

For E-Chain®	Part No. full set with tiwrap plate	Part No. full set without tiwrap plate	Number of teeth	Dim. A [mm]	Dim. B [mm]
E14-Z14.1. ►	114. 1. 12PZ	114. 1. 12P	2	-	26,3
E14-Z14.2. ►	114. 2. 12PZ	114. 2. 12P	3	10	36,3
E14-Z14.3. ►	114. 3. 12PZ	114. 3. 12P	4	23	49,3
E14-Z14.4. ►	114. 4. 12PZ	114. 4. 12P	5	35	62,3

Please add the Part No. with the requested index - e.g. 114. 1. 12

For the **preassembled** mode please add the index A1...A4 e.g. 114. 1. 12PZ A1



**Quicksnap** - the complete, detachable mounting unit, available upon request



**Quickfix** - mounting bracket with dowel, available upon request

**Additional Features**







Price index



IPA Qualification Certificate:  
Air Cleanless Class ISO Class 2  
(at v = 1 m/s) upon request



UL94-V2  
classifications



Torsional  
motion possible



Special equipment:  
Electrically conductive ESD/ATEX  
version upon request

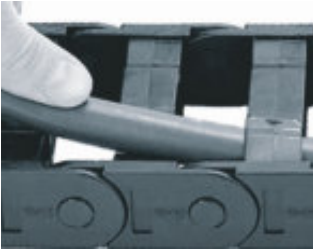

Just pull out cable by hand  
- and it's ready



When to use the Series E200/Z200:

- If filling is required without opening and closing lids
- If price is an issue
- If quiet operation is required



When not to use it:

- For applications with very high loads and long unsupported travel lengths
  - ▶ Series 2400/2450/2480/2500 E2/000, page 5.94
- If single-extrusion crossbars are required
  - ▶ Series 2400/2450/2480/2500 E2/000, page 5.94

- ① Large pins for long service life
- ② Limited torsion tolerance
- ③ "E" Series features split crossbar along the outer radius
- ④ "Z" Series features split crossbar along the inner radius
- ⑤ Cable-friendly interior
- ⑥ Mounting bracket with integrated strain relief
- ⑦ Dirt-repellent exterior
- ⑧ Very easy to fill - cables only have to be pushed in
- ⑨ The patented push-button principle holds the links together
- ⑩ 1- or 2-chamber system available

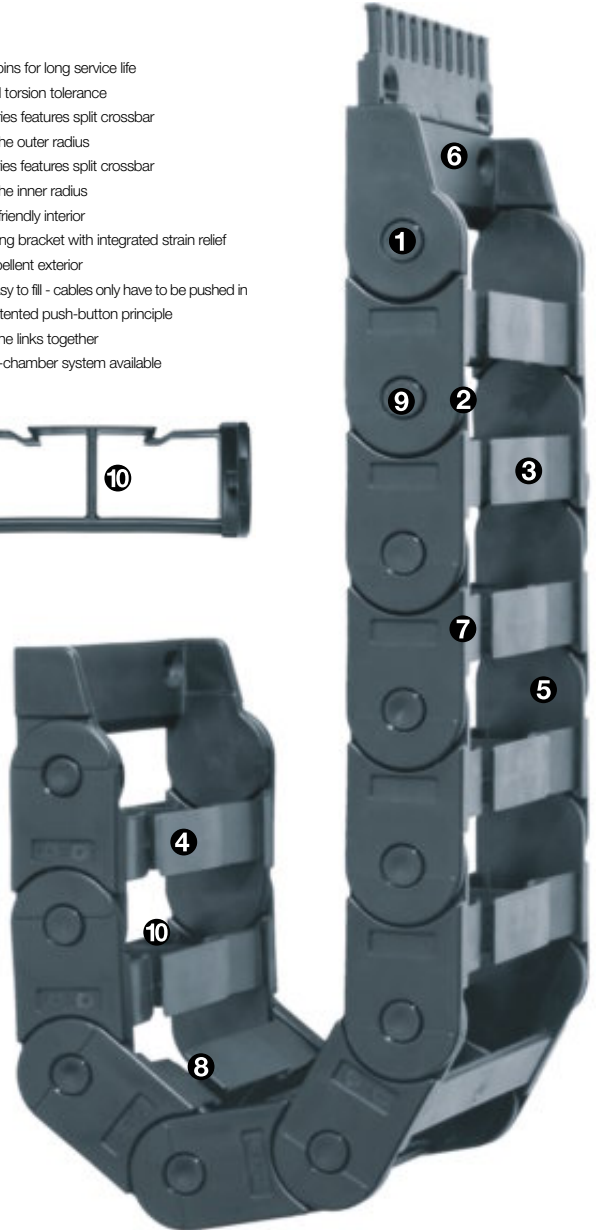
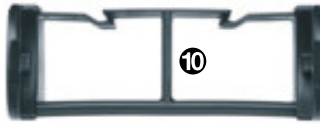

Order example complete E-Chain®

Please indicate chain-lengths or number of links Example: 1 m or 22 links

1 m E200.05.100.0



E-Chain®

1 set 2050.34.PZB



Mounting bracket

**Unsupported length**

$FL_G$  = with straight upper run

$FL_B$  = with permitted sag

Further information ► **Design, page 1.12**

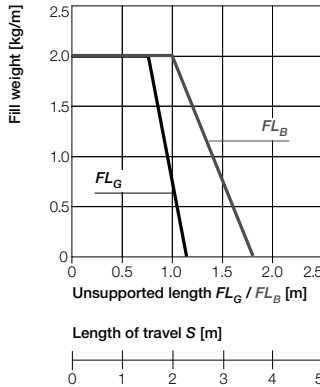
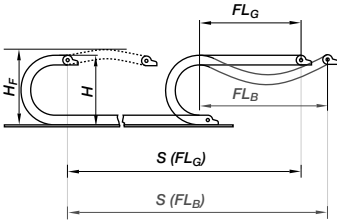

- $S$  = Length of travel
- $R$  = Bending radius
- $H$  = Nominal clearance height
- $H_F$  = Required clearance height
- $D$  = Overlength E-Chain® radius in final position
- $K = \pi \cdot R + \text{"safety"}$

**Other installation methods**

- Vertical, hanging  $\leq 10$  m
- Vertical, standing  $\leq 1,5$  m
- Side mounted, un supp.  $\leq 0,5$  m
- Rotary requires further calculation
- Unsupported length of upper run = upon request

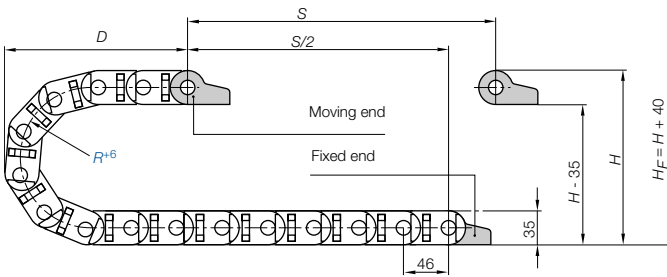

**Pitch = 46 mm/link    Links/m = 22 (1.012 mm)    Chain length =  $S/2 + K$**

$R$	055	075	100	150	200
$H + 4$	145	185	235	335	435
$D$	125	150	170	220	270
$K$	276	346	414	578	742



**Short travels - unsupported**

Unsupported E-Chains® feature positive camber over short travels. This must be accounted for when specifying the clearance height  $H_F$ . Please consult igus® if space is particularly restricted.

The required clearance height:  
 $H_F = H + 40$  mm  
(with 2,5 kg/m fill weight)

24,3

Easy Chain®  
Inner height: 24,3 mm

Phone +49- (0) 22 03-96 49-800  
Fax +49- (0) 22 03-96 49-222



► page 3.5

**Low cost PVC control cable for medium load requirements - Chainflex® CF130.UL**

UL, flame-retardant

Further information: [www.igus.de/en/CF130UL](http://www.igus.de/en/CF130UL)

IGUS® CHAINFLEX® CF130.UL



**TIP!**

Speed / acceleration $FL_G$	max. 20 [m/s] / max. 200 [m/s²]
Speed / acceleration $FL_B$	max. 3 [m/s] / max. 6 [m/s²]
Gliding speed / acceleration (maximum)	max. 3 [m/s] / max. 10 [m/s²]
Material (E-Chain®)- permitted temperature °C	igumid NB / -30° up to +100° C
Material (mounting brackets)* - permitted temperature °C	igumid G / -40° up to +130° C
Flammability class (E-Chain®), igumid NB	VDE 0304 IIC UL94 V2
Flammability class (mounting brackets), igumid G*	VDE 0304 IIC UL94 HB

\*Available in igumid NB upon request, please consult igus® for delivery time

**Technical Data**



Details of material properties  
► page 1.38

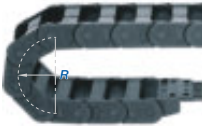
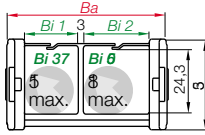
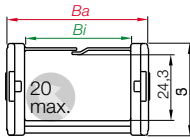

Part No. structure

E200.	05.	100.	0
-------	-----	------	---



Series E200 - split crossbar along the outer radius

Part No.	Bi [mm]	Ba [mm]	R [mm]	Bending radii				Weight [kg/m]
E200.05.□.0	57	74,4	055	075	100	150	200	~ 0,70

Ba: pin dimension approx. □- 0.3mm wider!

Supplement Part No. with required radius. Example: E200.05.100.0

0 = standard color, other colors ▶ page 1.39 · Pitch = 46 mm/link - Links/m = 22

Series E200 - split crossbar along the outer radius with 2-chamber system

Part No.	Bi/Bi2 [mm]	Ba [mm]	R [mm]	Bending radii				Weight [kg/m]
E200.2/35.□.0	37	94,4	055	075	100	150	200	~ 0,79
E200.2/50.□.0	50	120,4	055	075	100	150	200	~ 0,82

Ba: pin dimension approx. □- 0.3mm wider!

Supplement Part No. with required radius. Example: E200.2/50.100.0

0 = standard color, other colors ▶ page 1.39 · Pitch = 46 mm/link - Links/m = 22

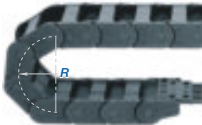
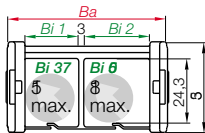
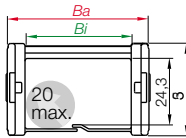

Part No. structure

Z200.	05.	100.	0
-------	-----	------	---



Series Z200 - split crossbar along the inner radius

Part No.	Bi [mm]	Ba [mm]	R [mm]	Bending radii				Weight [kg/m]
Z200.05.□.0	57	74,4	055	075	100	150	200	~ 0,70

Ba: pin dimension approx. □- 0.3mm wider!

Supplement Part No. with required radius. Example: Z200.05.100.0

0 = standard color, other colors ▶ page 1.39 · Pitch = 46 mm/link - Links/m = 22

Series Z200 - split crossbar along the inner radius with 2-chamber system

Part No.	Bi/Bi2 [mm]	Ba [mm]	R [mm]	Bending radii				Weight [kg/m]
Z200.2/35.□.0	37	94,4	055	075	100	150	200	~ 0,79
Z200.2/50.□.0	50	120,4	055	075	100	150	200	~ 0,82

Ba: pin dimension approx. □- 0.3mm wider!

Supplement Part No. with required radius. Example: Z200.2/50.100.0

0 = standard color, other colors ▶ page 1.39 · Pitch = 46 mm/link - Links/m = 22



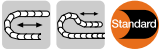

### The Standard - option polymer - pivoting

- Recommended for unsupported and gliding applications
- Well suited for tight installation conditions
- Strain relief with detachable tiewrap plates
- Variable traverse angle for flexible assembly
- The twistability of the E-Chain® and the option to assemble the mounting brackets on the fixed end and/or the moving end, enable various installation options

Moving end with bore  
(outer link) 2...3PZ(B)

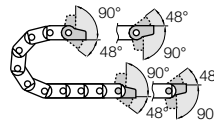

2...4PZ(B) Fixed end  
with pin (inner link)

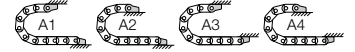

Possible installation conditions for assembled mounting brackets ▶ Order example "preassembled" below

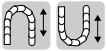

### Option polymer - locking

- Recommended for unsupported and gliding applications
- Furthermore:
- At very high speed and/or acceleration
  - If space is limited for height (the  $H_F$  measurement)
  - The twistability of the E-Chain® and the option to assemble the mounting brackets on the fixed end and/or the moving end, enable various installation options

Moving end with bore  
(outer link) 2...1PZ(B)

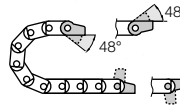

2...2PZ(B) Fixed end  
with pin (inner link)

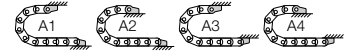

Possible installation conditions for assembled mounting brackets ▶ Order example "preassembled" below

2...3PZ(B) Standard! (pivoting)

2...1PZ(B) (locking)

Moving end

Standard! (pivoting) 2...4PZ(B)

(locking) 2...2PZ(B)

Fixed end

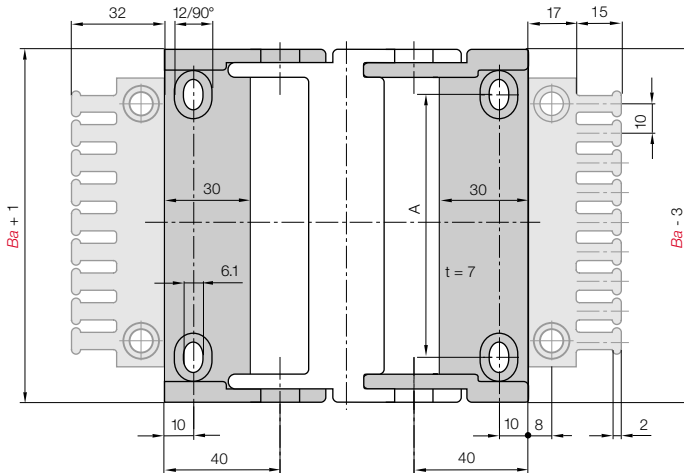

For E-Chain®	Part No. full set with tiewrap plate	Part No. tiewrap plate + 10 cable tiewraps	Part No. full set without tiewrap plate	Number of teeth	Dim. A [mm]
E200-Z200.05	2050. [ ] PZB	2050. [ ] PZBK1	2050. [ ] PZ	6	44
E200-Z200.2/35	2070. [ ] PZB	2070. [ ] PZBK1	2070. [ ] PZ	8	64
E200-Z200.2/50	2100. [ ] PZB	2100. [ ] PZBK1	2100. [ ] PZ	10	90

Please add the Part No. with the requested index - 34 for the pivoting configuration

e.g. 2050. [34] PZB or 12 for the locking configuration e.g. 2050. [12] PZB

For the preassembled mode please add the index [A1] ... [A4] e.g. 2050. [34] PZB [A1]

### Dimensions and order configurations

Strain relief is possible on the moving end and/or the fixed end.

Part No. structure (pivoting)

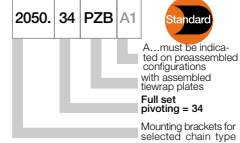

Full set, for both ends:

2050. [34] PZB +tiewrap plate

Single-part order:

2050. [3] PZB +tiewrap plate

Mounting bracket with bore

2050. [4] PZB +tiewrap plate

Mounting bracket with pin

Part No. structure (locking)

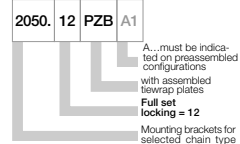

Full set, for both ends:

2050. [12] PZB +tiewrap plate

Single-part order:

2050. [1] PZB +tiewrap plate

Mounting bracket with bore

2050. [2] PZB +tiewrap plate

Mounting bracket with pin



▶ page 3.5



### Strain relief for polymer mounting brackets (pivoting or locking)

The strain relief tiewrap plates can be directly snapped onto the mounting bracket. After bolting the mounting brackets to the machine, the strain relief tiewrap plates are also firmly connected to the base. They do not need to be bolted on separately. Cable tiewraps secured the tiewrap plate "teeth" and the cable provide proper strain relief and save time. **Details ▶ chapter 10**



### Tiewrap plate as individual part

As individual component screwed on or can be plugged in the mounting brackets. **Details ▶ chapter 10**

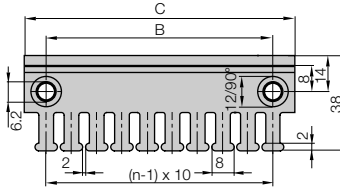
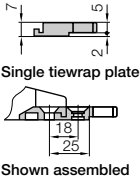

Tiewrap plate	No. of teeth n	Dim. C [mm]	Dim. B [mm]
2020.ZB	3	30	15
2030.ZB	4	40	20
2040.ZB	5	50	30
2050.ZB	6	60	40
2070.ZB	8	80	60
<b>2090.ZB =</b>			
(2030.ZB + 2040.ZB)	9	90	-
2100.ZB	10	100	80
<b>2125.ZB =</b>			
(2050.ZB + 2050.ZB)	12	120	-



### Cable tiewraps as individual part

Cable tiewraps 100 pieces/bag	Width x length	Max. Ø	Tensile strength
CFB.001	4,8 x 150 mm	36 mm	222 N



### "Double" strain relief

If an E-Chain® is harnessed with a very large number of cables, strain relief may be necessary at two levels. Our **2050.Z** strain relief system was developed for this purpose. It can be placed in any position along the E-Chain®. As required, the **2050.Z** strain relief system is simply clamped onto the crossbar of the chain link. No additional installation elements are needed. **Details ▶ chapter 10**

Art. Nr.	Width strain relief [mm]
2050.Z	60



Other strain relief elements - optional ▶ chapter 10

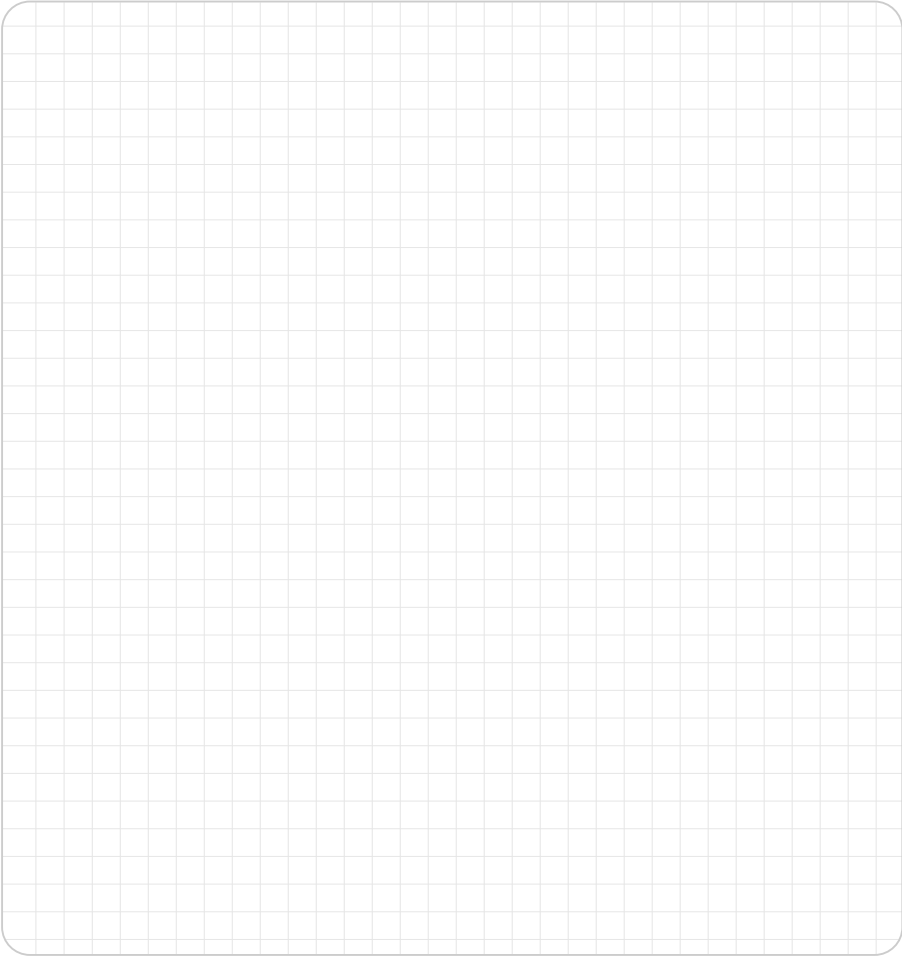

Easy Chain®  
Inner height: 24,3 mm

Phone +49- (0) 22 03-96 49-800  
Fax +49- (0) 22 03-96 49-222



▶ chapter 10



▶ page 3.5



Machinery of all kinds  
feature Easy Chain® -  
and reducing assembly time





Price index



IPA Qualification Certificate:  
Air Cleanless Class ISO Class 2  
(at v = 1 m/s) upon request



UL94-V2  
classifications



Torsional  
motion possible



Special equipment:  
Electrically conductive ESD/ATEX  
version upon request



Just push the cables with your thumb  
into the E-Chain® - and it's ready



When to use the Series E16/Z16:

- If filling is required without opening and closing lids
- If price is an issue
- If quiet operation is required



When not to use it:

- For applications with very high loads and long unsupported travel lengths
  - ▶ Series 2600/2650/2680/2700 E2/000, page 5.108
- If a E-Chain® is needed with a high locking crossbar
  - ▶ Series 2600/2650/2680/2700 E2/000, page 5.108

- ① Limited torsion tolerance
- ② Small pitch for low-noise, smooth operation
- ③ Very easy to fill - ideal for harnessed cable assemblies
- ④ Cable-friendly interior
- ⑤ "E" Series features split crossbar along the outer radius
- ⑥ "Z" Series features split crossbar along the inner radius
- ⑦ Mounting brackets with integrated strain relief
- ⑧ The patented push-button principle holds the links together



Special solution -  
opening gap  
Part No. E16.2.100N3



Special solution -  
opening gap  
Part No. Z16.2.075N3



Order example complete E-Chain®

Please indicate chain-lengths or number of links Example: 1 m or 33 links

1 m E16.3.060.0



E-Chain®

1 set 117.3.12PZ



Mounting bracket

**Unsupported length**

$FL_G$  = with straight upper run

$FL_B$  = with permitted sag

Further information ► **Design, page 1.12**

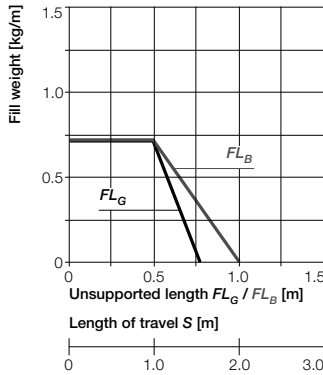
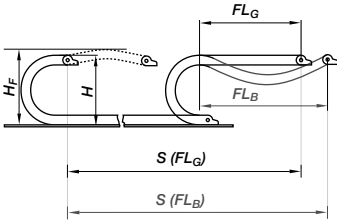

- $S$  = Length of travel
- $R$  = Bending radius
- $H$  = Nominal clearance height
- $H_F$  = Required clearance height
- $D$  = Overlength E-Chain® radius in final position
- $K = \pi \cdot R + \text{"safety"}$

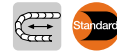
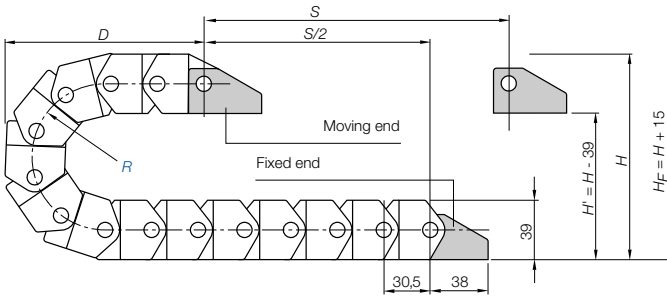

**Short travels - unsupported**

Unsupported E-Chains® feature positive camber over short travels. This must be accounted for when specifying the clearance height  $H_F$ . Please consult igus® if space is particularly restricted.

**Pitch = 30,5 mm/link Links/m = 33 (1.006,5mm) Chain length =  $S/2 + K$**

$R$	040	060	075	100
$H$	119	159	189	239
$D$	085	110	130	155
$K$	210	270	305	395

The required clearance height:  
 **$H_F = H + 15$  mm**  
(with 0,3 kg/m fill weight)



Easy Chain®  
Inner height: 32 mm

Phone +49- (0) 22 03-96 49-800  
Fax +49- (0) 22 03-96 49-222



► page 3.5

Speed / acceleration $FL_G$	max. 20 [m/s] / max. 200 [m/s²]
Speed / acceleration $FL_B$	max. 3 [m/s] / max. 6 [m/s²]
Gliding speed / acceleration (maximum)	max. 3 [m/s] / max. 10 [m/s²]
Material (E-Chain®) - permitted temperature °C	igumid NB / -30° up to +100° C
Material (mounting brackets)* - permitted temperature °C	igumid G / -40° up to +130° C
Flammability class (E-Chain®), igumid NB	VDE 0304 IIC UL94 V2
Flammability class (mounting brackets), igumid G*	VDE 0304 IIC UL94 HB

\*Available in igumid NB upon request, please consult igus® for delivery time

**Technical Data**



Details of material properties  
► page 1.38

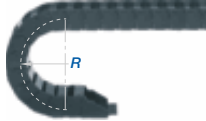
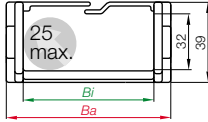

Part No. structure

E16. 3. 060. 0



Series E16 - split crossbar along the outer radius

Part No.	Bi [mm]	Ba [mm]	R [mm]	Bending radii			Weight [kg/m]
E16.2. .0	23	37,5	060	075	100	~ 0,51	
E16.3. .0	36	50,5	060	075	100	~ 0,57	
E16.4. .0	48	62,5	060	075	100	~ 0,62	
E16.5. .0	63	78,5	060	075	100	~ 0,75	
E16.6. .0	80	95,5	060	075	100	~ 0,83	
E16.7. .0	100	115,3	060	075	100	~ 0,91	

Ba: pin dimension approx. 0,3 - 0,7 mm wider

The bending radius [125] is available upon request.

Delivery time: approx. 3-4 weeks after receipt of order!

Supplement Part No. with required radius. Example: E16.3.060.0

0 = standard color, other colors ▶ page 1.39 · Pitch = 30,5 mm/link - Links/m = 33

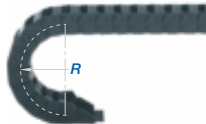
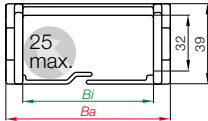

Part No. structure

Z16. 3. 060. 0



Series Z16 - split crossbar along the inner radius

Part No.	Bi [mm]	Ba [mm]	R [mm]	Bending radii			Weight [kg/m]
Z16.2. .0	23	37,5	060	075	100	~ 0,51	
Z16.3. .0	36	50,5	060	075	100	~ 0,57	
Z16.4. .0	48	62,5	040	060	075 100	~ 0,62	
Z16.5. .0	63	78,5	060	075	100	~ 0,75	
Z16.6. .0	80	95,5	060	075	100	~ 0,83	
Z16.7. .0	100	115,3	060	075	100	~ 0,91	

Ba: pin dimension approx. 0,3 - 0,7 mm wider

The bending radius [125] is available upon request.

Delivery time: approx. 3-4 weeks after receipt of order!

Supplement Part No. with required radius. Example: Z16.3.060.0

0 = standard color, other colors ▶ page 1.39 · Pitch = 30,5 mm/link - Links/m = 33





**Polymer, one-piece**

- One-piece mounting bracket
- Corrosion-resistant
- Available preassembled
- Inner and outer attachment possible
- Available with integrated strain relief tiwrap plates
- 90° \* not for Series Z16

Moving end with bore  
(outer link) 117...1P(Z)

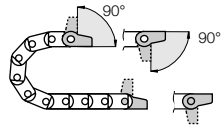

117...2P(Z) Fixed end  
with pin (inner link)

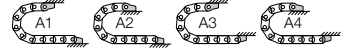
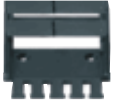

Possible installation conditions for assembled mounting brackets ▶ Order example "preassembled" below

117...1P(Z)  
Moving end

117...2P(Z)  
Fixed end

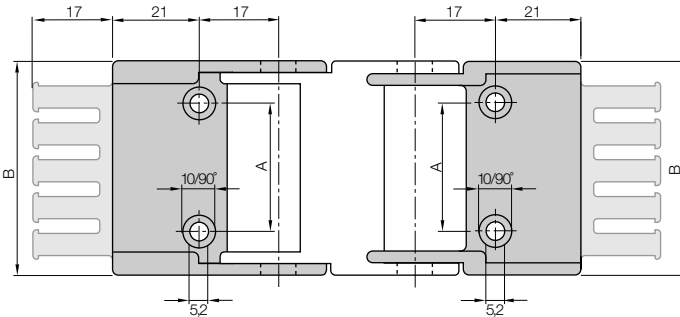

**Dimensions and order configurations**

Strain relief is possible on the moving end and/or the fixed end.

**Part No. structure**

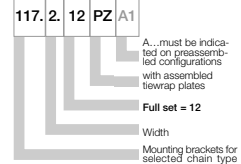

For	Part No.	Part No.	Number	Dim.	Dim.
E-Chain®	full set with tiwrap plate	full set without tiwrap plate	of teeth	A [mm]	B [mm]
E16-Z16.2. ▶	117. <u>2</u> .12PZ	117. <u>2</u> .12P	3	12	35,5
E16-Z16.3. ▶	117. <u>3</u> .12PZ	117. <u>3</u> .12P	4	25	48,5
E16-Z16.4. ▶	117. <u>4</u> .12PZ	117. <u>4</u> .12P	5	37	60,5
E16-Z16.5. ▶	117. <u>5</u> .12PZ	117. <u>5</u> .12P	6	48	76,0
E16-Z16.6. ▶	117. <u>6</u> .12PZ	117. <u>6</u> .12P	8	65	93,0
E16-Z16.7. ▶	117. <u>7</u> .12PZ	117. <u>7</u> .12P	10	85	113,0

Please add the Part No. with the requested index - e.g. 117. 2 .12PZ

For the preassembled mode please add the index A1 ... A4 e.g. 117. 2 .12PZ A1

**Full set, for both ends:**

117. 2 .12 PZ +tiwrap plate

**Single-part order:**

117. 2 .1 PZ +tiwrap plate

Mounting bracket with bore

117. 2 .2 PZ +tiwrap plate

Mounting bracket with pin



**Quicksnap** - the complete, detachable mounting unit, available upon request



**Quickfix** - mounting bracket with dowel, available upon request

**Additional Features**





Price index



IPA Qualification Certificate:  
Air Cleanless Class ISO Class 2  
(at v = 1 m/s) upon request



UL94-V2  
classifications



Torsional  
motion possible



Special equipment:  
Electrically conductive ESD/ATEX  
version upon request



Just push the cables with your thumb  
into the E-Chain® - and it's ready



When to use the Series E26/Z26:

- If filling is required without opening and closing lids
- If price is an issue
- If quiet operation is required



When not to use it:

- For applications with very high loads and long unsupported travel lengths
  - ▶ Series 3400/3450/3480/3500 E2/000, page 5.120
- If a E-Chain® is needed with a high locking crossbar
  - ▶ Series 3400/3450/3480/3500 E2/000, page 5.120

- ① Limited torsion tolerance
- ② Large pins for long service life
- ③ Cable-friendly interior
- ④ Integrated strain relief option
- ⑤ "E" Series features split crossbar along the outer radius
- ⑥ "Z" Series features split crossbar along the inner radius
- ⑦ Dirt-repellent exterior
- ⑧ Very easy to fill
- ⑨ 1-, 2- or 3-chamber system available
- ⑩ The patented push-button principle holds the links together

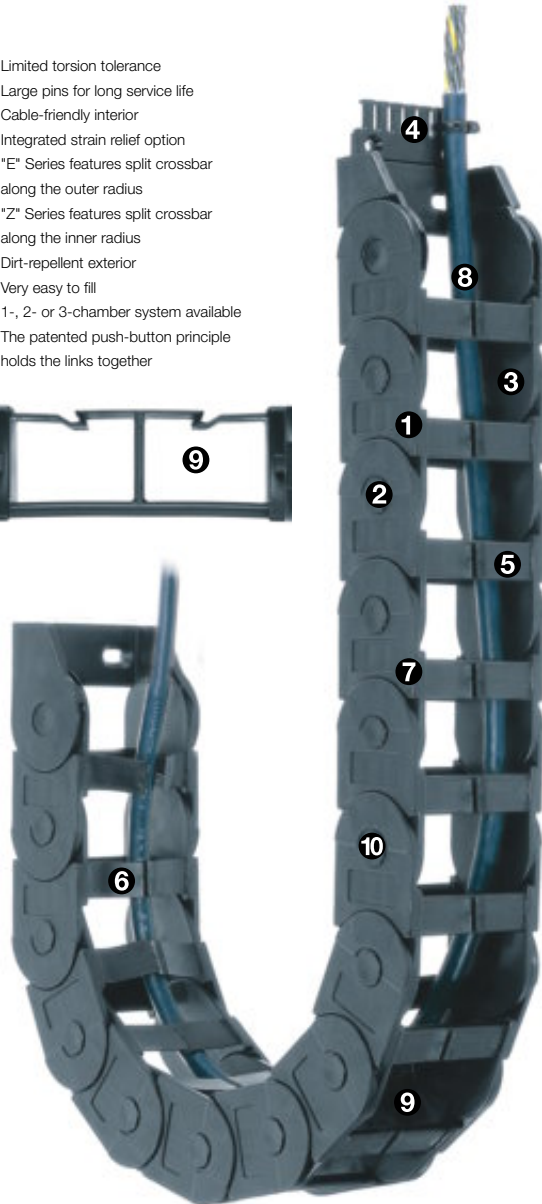
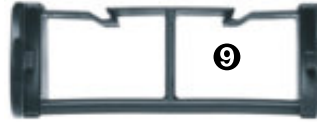

Order example complete E-Chain®

Please indicate chain-lengths or number of links **Example: 1 m or 18 links**

1 m **E26.07.150.0**



**E-Chain®**

1 set **2607.34.PZB**



**Mounting bracket**

**Unsupported length**

$FL_G$  = with straight upper run

$FL_B$  = with permitted sag

Further information ► **Design, page 1.12**

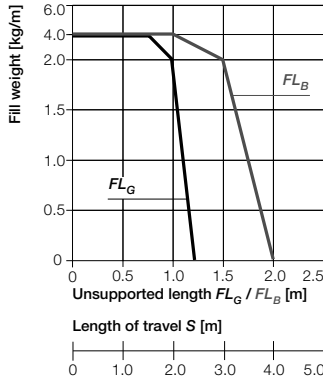
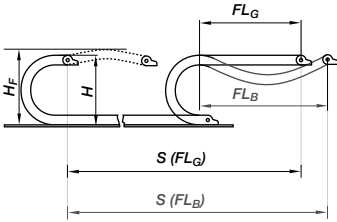

- $S$  = Length of travel
- $R$  = Bending radius
- $H$  = Nominal clearance height
- $H_F$  = Required clearance height
- $D$  = Overlength E-Chain® radius in final position
- $K = \pi \cdot R + \text{"safety"}$

**Other installation methods**

- Vertical, hanging  $\leq 10$  m
- Vertical, standing  $\leq 1,5$  m
- Side mounted, un supp.  $\leq 0,5$  m
- Rotary requires further calculation
- Unsupported length of upper run = upon request

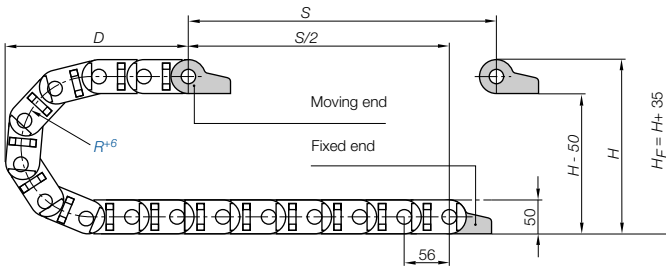

**Pitch = 56 mm/link   Links/m = 18 (1.008 mm)   Chain length =  $S/2 + K$**

R	063	075	100	125	150	175	200	250
$H + 5$	180	200	250	300	350	400	450	550
D	140	150	175	200	225	250	275	325
K	335	375	475	550	650	750	825	925



**Short travels - unsupported**

Unsupported E-Chains® feature positive camber over short travels. This must be accounted for when specifying the clearance height  $H_F$ . Please consult igus® if space is particularly restricted.

The required clearance height:  
 **$H_F = H + 35$  mm**  
(with 2,0 kg/m fill weight)

**Low cost, oil-proof, shielded - Chainflex® CF211 - measuring system cable**

oil-proof in accordance with VDE, flamae-retardant, PVC outer jacket, bending radius 10xd  
Further information: [www.igus.de/en/CF211](http://www.igus.de/en/CF211)

IGUS® CHAINFLEX® CF211



**TIP!**

Speed / acceleration $FL_G$	max. 20 [m/s] / max. 200 [m/s²]
Speed / acceleration $FL_B$	max. 3 [m/s] / max. 6 [m/s²]
Gliding speed / acceleration (maximum)	max. 3 [m/s] / max. 10 [m/s²]
Material (E-Chain®)- permitted temperature °C	igumid NB / -30° up to +100° C
Material (mounting brackets)* - permitted temperature °C	igumid G / -40° up to +130° C
Flammability class (E-Chain®), igumid NB	VDE 0304 IIC UL94 V2
Flammability class (mounting brackets), igumid G*	VDE 0304 IIC UL94 HB

\*Available in igumid NB upon request, please consult igus® for delivery time

**Technical Data**



Details of material properties  
► page 1.38



Easy Chain®  
Inner height: 36,5 mm

Phone +49- (0) 22 03-96 49-800  
Fax +49- (0) 22 03-96 49-222



► page 3.5



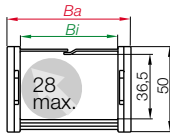

Series E26 - split crossbar along the outer radius

Part No.	Bi [mm]	Ba [mm]	R [mm]	Bending radii	Weight [kg/m]
E26.07.□.0	75	92	063	075 100 125 150 175 200 250	~ 0,96

Ba: pin dimension approx. 0,3 - 0,5 mm wider!

Supplement Part No. with required radius. Example: E26.07.150.0

0 = standard color, other colors ▶ page 1.39 · Pitch = 56 mm/link - Links/m = 18

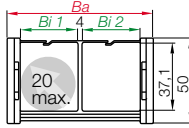

Series E26 - split crossbar along the outer radius with 2-chamber system

Part No.	Bi1/Bi2 [mm]	Ba [mm]	R [mm]	Bending radii	Weight [kg/m]
E26.2/45.□.0	48/48	117	063	075 100 125 150 175 200 250	~ 1,14

Ba: pin dimension approx. 0,3 - 0,5 mm wider!

Supplement Part No. with required radius. Example: E26.2/45.150.0

0 = standard color, other colors ▶ page 1.39 · Pitch = 56 mm/link - Links/m = 18

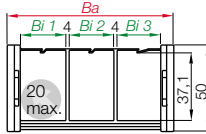

Series E26 - split crossbar along the outer radius with 3-chamber system

Part No.	Bi1/Bi2/Bi3 [mm]	Ba [mm]	R [mm]	Bending radii	Weight [kg/m]
E26.3/45.□.0	47/48/47	167	063	075 100 125 150 175 200 250	~ 1,30

Ba: pin dimension approx. 0,3 - 0,5 mm wider!

Supplement Part No. with required radius. Example: E26.3/45.150.0

0 = standard color, other colors ▶ page 1.39 · Pitch = 56 mm/link - Links/m = 18

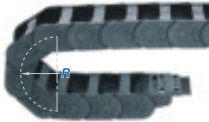

Part No. structure

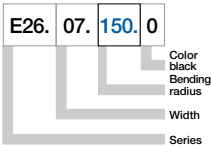

Series Z26 - split crossbar along the inner radius

Part No.	$B_i$ [mm]	$B_a$ [mm]	$R$ [mm]	Bending radii										Weight [kg/m]	
Z26.07.□.0	75	92	063	075	100	125	150	175	200	250					- 0,96

$B_a$ : pin dimension approx. 0,3 - 0,5 mm wider!

Supplement Part No. with required radius. Example: Z26.07.150.0

0 = standard color, other colors ► page 1.39 · Pitch = 56 mm/link - Links/m = 18

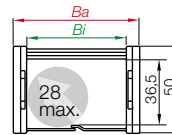

Series Z26 - split crossbar along the inner radius with 2-chamber system

Part No.	$B_i/Bi_2$ [mm]	$B_a$ [mm]	$R$ [mm]	Bending radii										Weight [kg/m]	
Z26.2/45.□.0	48/48	117	063	075	100	125	150	175	200	250					= 1,14

$B_a$ : pin dimension approx. 0,3 - 0,5 mm wider!

Supplement Part No. with required radius. Example: Z26.2/45.150.0

0 = standard color, other colors ► page 1.39 · Pitch = 56 mm/link - Links/m = 18

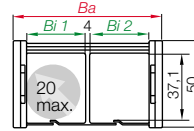

Series Z26 - split crossbar along the inner radius with 3-chamber system

Part No.	$B_i/Bi_2/Bi_3$ [mm]	$B_a$ [mm]	$R$ [mm]	Bending radii										Weight [kg/m]	
Z26.3/45.□.0	47/48/47	167	063	075	100	125	150	175	200	250					= 1,30

$B_a$ : pin dimension approx. 0,3 - 0,5 mm wider!

Supplement Part No. with required radius. Example: Z26.3/45.150.0

0 = standard color, other colors ► page 1.39 · Pitch = 56 mm/link - Links/m = 18

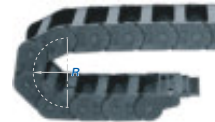
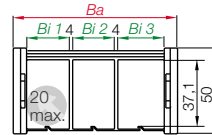

Part No. structure

Z26.	07.	150.	0
------	-----	------	---



Easy Chain®  
Inner height: 36,5 mm

Phone +49- (0) 22 03-96 49-800  
Fax +49- (0) 22 03-96 49-222



► page 3.5

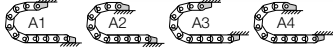

Possible installation conditions for assembled mounting brackets ▶ Order example "preassembled" below

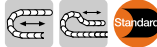

### The Standard - option polymer - pivoting

- Recommended for unsupported and gliding applications
- Well suited for tight installation conditions
- Strain relief with detachable tiwrap plates
- Variable traverse angle for flexible assembly
- The twistability of the E-Chain® and the option to assemble the mounting brackets on the fixed end and/or the moving end, enable various installation options

Moving end with bore  
(outer link) 26...3PZ(B)

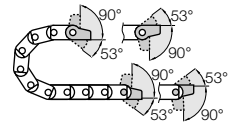

26...4PZ(B) Fixed end  
with pin (inner link)



Possible installation conditions for assembled mounting brackets ▶ Order example "preassembled" below

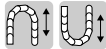

### Option polymer - locking

- Recommended for unsupported and gliding applications
- At very high speed and/or acceleration
- If space is limited for height (the  $H_F$  measurement)
- The twistability of the E-Chain® and the option to assemble the mounting brackets on the fixed end and/or the moving end, enable various installation options

Moving end with bore  
(outer link) 26...1PZ(B)

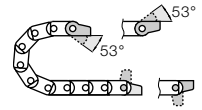

26...2PZ(B) Fixed end  
with pin (inner link)

## Dimensions and order configurations

Strain relief is possible on the moving end and/or the fixed end.

Part No. structure (pivoting)

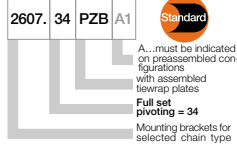

Full set, for both ends:

2607. [34] PZB + tiwrap plate

Single-part order:

2607. [3] PZB + tiwrap plate

Mounting bracket with bore

2607. [4] PZB + tiwrap plate

Mounting bracket with pin

Part No. structure (locking)

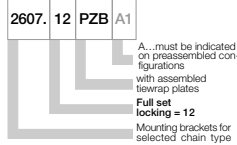

Full set, for both ends:

2607. [12] PZB + tiwrap plate

Single-part order:

2607. [1] PZB + tiwrap plate

Mounting bracket with bore

2607. [2] PZB + tiwrap plate

Mounting bracket with pin

26...3PZ(B) Standard! (pivoting)

26...1PZ(B) (locking)

Moving end

Standard! (pivoting) 26...4PZ(B)

(locking) 26...2PZ(B)

Fixed end

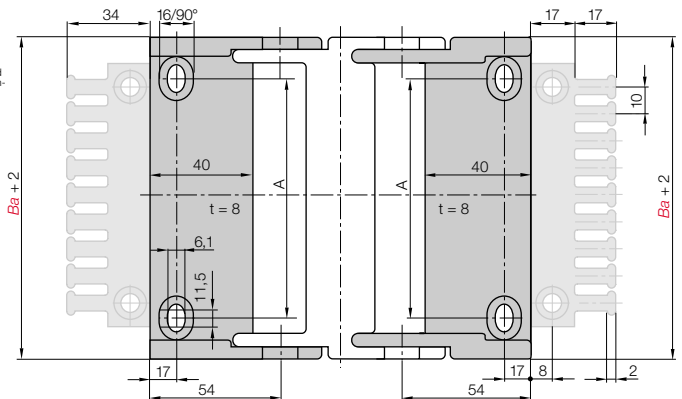

For	Part No.	Part No.	Part No.	Number	Dim.
E-Chain®	full set with tiwrap plate	tiwrap plate + 10 cable tiwraps	full set without tiwrap plate	of teeth	A [mm]
E26-Z26.07	▶ 2607. [ ] PZB	2607. [ ] PZBK1	2607. [ ] PZ	7	55
E26-Z26.2/45	▶ 2610. [ ] PZB	2610. [ ] PZBK1	2610. [ ] PZ	10	80
E26-Z26.3/45	▶ 2615. [ ] PZB	2615. [ ] PZBK1	2615. [ ] PZ	15	130

Please add the Part No. with the requested index - 34 for the pivoting configuration

e.g. 2607. [34] PZB or 12 for the locking configuration e.g. 2607. [12] PZB

For the preassembled mode please add the index [A1]...[A4] e.g. 2607. [34] PZB [A1]

**Strain relief for polymer mounting brackets (pivoting or locking)**

The strain relief tiewrap plates can be directly snapped onto the mounting bracket. After bolting the mounting brackets to the machine, the strain relief tiewrap plates are also firmly connected to the base. They do not need to be bolted separately. Cable tiewraps secured the tiewrap plate "teeth" and the cable provide proper strain relief and save time. **Details ▶ chapter 10**



Tiewrap plate	No. of teeth <i>n</i>	Dim. C [mm]	Dim. B [mm]	Center bore
3050.ZB	5	50	30	-
3075.ZB	7	75	55	-
3100.ZB	10	100	80	-
3115.ZB	11	115	95	-
3125.ZB	12	125	105	-
3150.ZB	15	150	130	-
3175.ZB	17	175	155	-
3200.ZB	20	200	180	+
3225.ZB	22	225	205	+
3250.ZB	25	250	230	+

(- = no / + = yes)

**Tiewrap plate as individual part**

As individual component screwed on or can be plugged in the mounting brackets. **Details ▶ chapter 10**

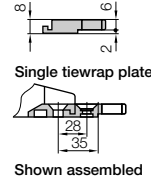
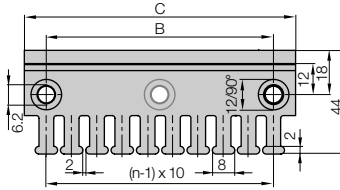

**Cable tiewraps as individual part**

Cable tiewraps 100 pieces/bag	Width x length	Max. Ø	Tensile strength
CFB.001	4,8 x 150 mm	36 mm	222 N



Other strain relief elements - optional ▶ chapter 10



▶ chapter 10



▶ page 3.5



Price index



IPA Qualification Certificate:  
Air Cleanless Class ISO Class 2  
(at v = 1 m/s) upon request



UL94-V2  
classifications



Torsional  
motion possible



Special equipment:  
Electrically conductive ESD/ATEX  
version upon request



Just push the cables with your thumb  
into the E-Chain® - and it's ready



When to use the Series E300/Z300:

- If filling is required without opening and closing lids
- If price is an issue
- If quiet operation is required



When not to use it:

- For applications with very high loads and long unsupported travel lengths
- Series 3400/3450/3480/3500  
E2/000, page 5.120

- 1 Limited torsion tolerance
- 2 Large pins for long service life
- 3 Cable-friendly interior
- 4 Integrated strain relief option
- 5 "E" Series features split crossbar along the outer radius
- 6 "Z" Series features split crossbar along the inner radius
- 7 Dirt-repellent exterior
- 8 Very easy to fill
- 9 Interior separation possible
- 10 1-, 2- or 3-chamber system available
- 11 The patented push-button principle holds the links together

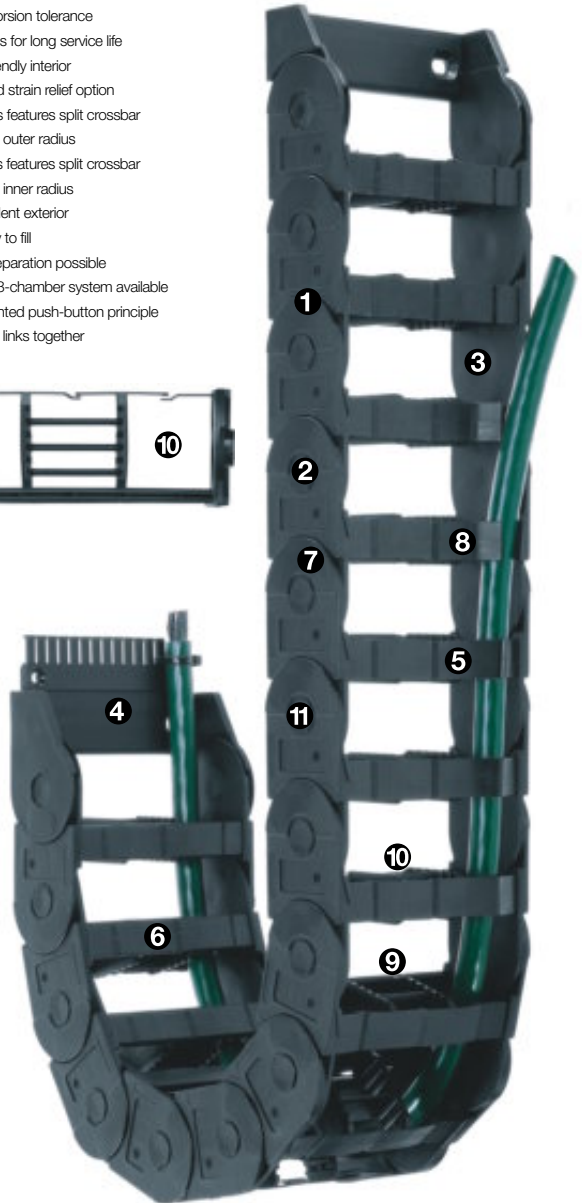

Order example complete E-Chain®

Please indicate chain-lengths or number of links Example: 1 m or 15 Links

1 m E300.075.100.0



E-Chain®

1 set 3075.34.PZB



Mounting bracket

**Unsupported length**

$FL_G$  = with straight upper run

$FL_B$  = with permitted sag

Further information ► **Design, page 1.12**

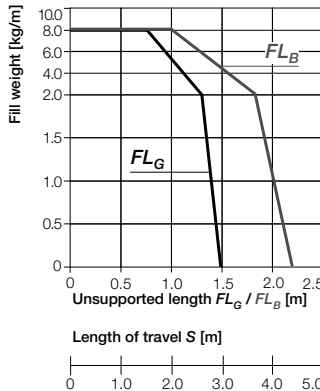
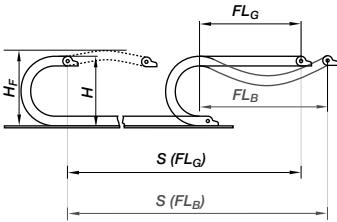

- $S$  = Length of travel
- $R$  = Bending radius
- $H$  = Nominal clearance height
- $H_F$  = Required clearance height
- $D$  = Overlength E-Chain® radius in final position
- $K = \pi \cdot R + \text{"safety"}$

**Other installation methods**

- Vertical, hanging  $\leq 10$  m
- Vertical, standing  $\leq 1,5$  m
- Side mounted, un supp.  $\leq 0,5$  m
- Rotary requires further calculation
- Unsupported length of upper run = upon request

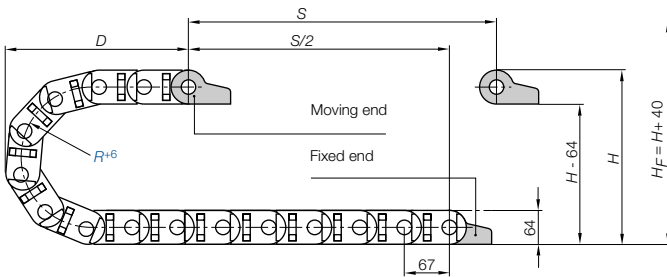

**Pitch = 67 mm/link   Links/m = 15 (1.005 mm)   Chain length =  $S/2 + K$**

R	075	100	125	150	200	250	300
H +5	215	265	315	365	465	565	665
D	150	200	225	250	300	350	400
K	400	500	650	725	875	1050	1225



**Short travels - unsupported**

Unsupported E-Chains® feature positive camber over short travels. This must be accounted for when specifying the clearance height  $H_F$ . Please consult igus® if space is particularly restricted.

The required clearance height:  
 **$H_F = H + 40$  mm**  
(with 2,5 kg/m fill weight)

**Oil-proof, shielded PVC control cable for high load requirements - Chainflex® CF6**

oil-proof in accordance with VDE, flame-retardante, shielded, bending radius from 6,8xd  
Further information: [www.igus.de/en/CF6](http://www.igus.de/en/CF6)

IGUS® CHAINFLEX® CF6



**TIP!**

Speed / acceleration $FL_G$	max. 20 [m/s] / max. 200 [m/s²]
Speed / acceleration $FL_B$	max. 3 [m/s] / max. 6 [m/s²]
Gliding speed / acceleration	max. 3 [m/s] / max. 10 [m/s²]
Material (E-Chain®)- permitted temperature °C	igumid NB / -30° up to +100° C
Material (mounting brackets)* - permitted temperature °C	igumid G / -40° up to +130° C
Flammability class (E-Chain®), igumid NB	VDE 0304 IIC UL94 V2
Flammability class (mounting brackets), igumid G*	VDE 0304 IIC UL94 HB

\*Available in igumid NB upon request, please consult igus® for delivery time

**Technical Data**



Details of material properties  
► page 1.38

48,5

Easy Chain®  
Inner height: 48,5 mm

Phone +49- (0) 22 03-96 49-800  
Fax +49- (0) 22 03-96 49-222



► page 3.5



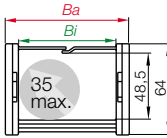

Series E300 - split crossbar along the outer radius

Part No.	Bi [mm]	Ba [mm]	R [mm]	Bending radii	Weight [kg/m]
E300.075. <input type="text"/> .0	75	95	075	100 125 150 200 250 300	~ 1,60

Ba: pin dimension approx. 0,3 - 0,5 mm wider!

Supplement Part No. with required radius. Example: E300.075.  .0

0 = standard color, other colors ▶ page 1.39 · Pitch = 67 mm/link - Links/m = 15

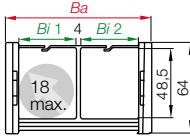

Series E300 - split crossbar along the outer radius with 2-chamber system

Part No.	Bi1/Bi2 [mm]	Ba [mm]	R [mm]	Bending radii	Weight [kg/m]
E300.2/45. <input type="text"/> .0	48/48	120	075	100 125 150 200 250 300	~ 1,78

Ba: pin dimension approx. 0,3 - 0,5 mm wider!

Supplement Part No. with required radius. Example: E300.2/45.  .0

0 = standard color, other colors ▶ page 1.39 · Pitch = 67 mm/link - Links/m = 15

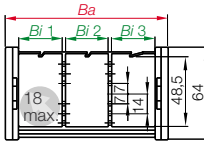

Series E300 - split crossbar along the outer radius with 3-chamber system

Part No.	Bi1/Bi2/Bi3 [mm]	Ba [mm]	R [mm]	Bending radii	Weight [kg/m]
E300.3/45. <input type="text"/> .0	47/46/47	170	075	100 125 150 200 250 300	~ 1,92

Ba: pin dimension approx. 0,3 - 0,5 mm wider!

Supplement Part No. with required radius. Example: E300.3/45.  .0

0 = standard color, other colors ▶ page 1.39 · Pitch = 1 m = 15 Links

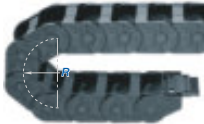

Part No. structure

E300.075.  .0



Series Z300 - split crossbar along the inner radius

Part No.	Bi [mm]	Ba [mm]	R [mm]	Bending radii	Weight [kg/m]
Z300.075.□.0	75	95	075	100 125 150 200 250 300	~1,60

Ba: pin dimension approx. 0,3 - 0,5 mm wider!

Supplement Part No. with required radius. Example: Z300.075.□100.0

0 = standard color, other colors ▶ page 1.39 · Pitch = 67 mm/link - Links/m = 15

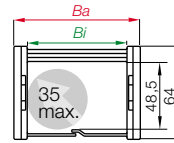

Series Z300 - split crossbar along the inner radius with 2-chamber system

Part No.	Bi1/Bi2 [mm]	Ba [mm]	R [mm]	Bending radii	Weight [kg/m]
Z300.2/45.□.0	48/48	120	075	100 125 150 200 250 300	~ 1,78

Ba: pin dimension approx. 0,3 - 0,5 mm wider!

Supplement Part No. with required radius. Example: Z300.2/45.□100.0

0 = standard color, other colors ▶ page 1.39 · Pitch = 67 mm/link - Links/m = 15

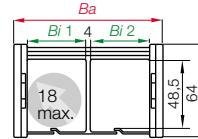

Series Z300 - split crossbar along the inner radius with 3-chamber system

Part No.	Bi1/Bi2/Bi3 [mm]	Ba [mm]	R [mm]	Bending radii	Weight [kg/m]
Z300.3/45.□.0	47/46/47	170	075	100 125 150 200 250 300	~ 1,92

Ba: pin dimension approx. 0,3 - 0,5 mm wider!

Supplement Part No. with required radius. Example: Z300.3/45.□100.0

0 = standard color, other colors ▶ page 1.39 · Pitch = 67 mm/link - Links/m = 15

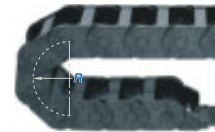
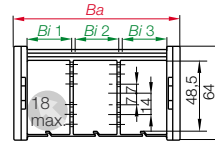

Part No. structure

Z300.075.	100.	0
-----------	------	---

Color black  
Bending radius  
Width  
Series

Easy Chain®  
Inner height: 48,5 mm

Phone +49- (0) 22 03-96 49-800  
Fax +49- (0) 22 03-96 49-222

Easy Chain® | Series E300 · Z300 | Accessories | Interior Separation

Optional shelving for E300.3/45 · Z300.3/45

- Shelving enables subdivision of the inner space of the E-Chain® Series E300.3/45 and Z300.3/45. Shelves are only used when a horizontal subdivision is required.
- In standard configurations, shelves are installed in every other link.

Shelves	
unassembled	386.54
assembled	387.54

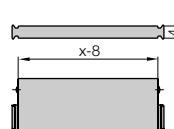
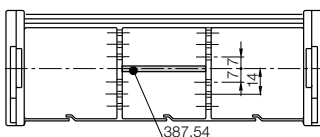

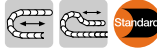

### The Standard - option polymer - pivoting

- Recommended for unsupported and gliding applications
- Well suited for tight installation conditions
- Strain relief with detachable tiwrap plates
- Variable traverse angle for flexible assembly
- The twistability of the E-Chain® and the option to assemble the mounting brackets on the fixed end and/or the moving end, enable various installation options

Moving end with bore  
(outer link) 3...3PZ(B)

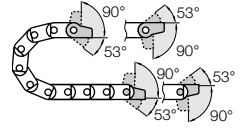

3...4PZ(B) Fixed end  
with pin (inner link)

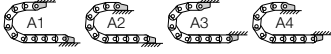

Possible installation conditions for assembled mounting brackets ▶ Order example "preassembled" below

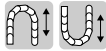

### Option polymer - locking

- Recommended for unsupported and gliding applications
- At very high speed and/or acceleration
- If space is limited for height (the  $H_F$  measurement)
- The twistability of the E-Chain® and the option to assemble the mounting brackets on the fixed end and/or the moving end, enable various installation options

Moving end with bore  
(outer link) 3...1PZ(B)

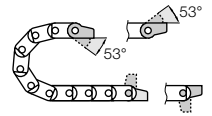

3...2PZ(B) Fixed end  
with pin (inner link)

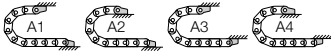

Possible installation conditions for assembled mounting brackets ▶ Order example "preassembled" below

## Dimensions and order configurations

Strain relief is possible on the moving end and/or the fixed end.

### Part No. structure (pivoting)

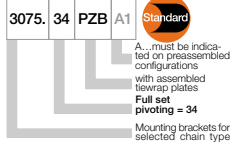

### Full set, for both ends:

3075. 34 PZB +tiwrap plate

### Single-part order:

3075. 3 PZB +tiwrap plate

Mounting bracket with bore

3075. 4 PZB +tiwrap plate

Mounting bracket with pin

### Part No. structure (locking)

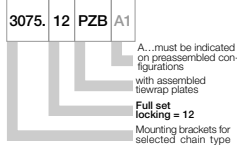

### Full set, for both ends:

3075. 12 PZB +tiwrap plate

### Single-part order:

3075. 1 PZB +tiwrap plate

Mounting bracket with bore

3075. 2 PZB +tiwrap plate

Mounting bracket with pin

3...3PZ(B) Standard! (pivoting)

3...1PZ(B) (locking)

Moving end

Standard! (pivoting) 3...4PZ(B)

(locking) 3...2PZ(B)

Fixed end

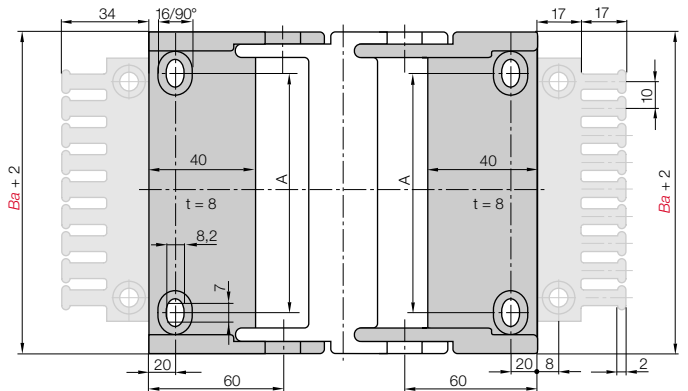

For E-Chain®	Part No. full set with tiwrap plate	Part No. tiwrap plate + 10 cable tiwraps	Part No. full set without tiwrap plate	Number of teeth	Dim. A [mm]
E300/Z300.075 ▶	3075. <input type="checkbox"/> PZB	3075. <input type="checkbox"/> PZBK1	3075. <input type="checkbox"/> PZ	7	53
E300/Z300.2/45 ▶	3100. <input type="checkbox"/> PZB	3100. <input type="checkbox"/> PZBK1	3100. <input type="checkbox"/> PZ	10	78
E300/Z300.3/45 ▶	3150. <input type="checkbox"/> PZB	3150. <input type="checkbox"/> PZBK1	3150. <input type="checkbox"/> PZ	15	128

Please add the Part No. with the requested index - 34 for the pivoting configuration

e.g. 3075. 34 PZB or 12 for the locking configuration e.g. 3075. 12 PZB

For the preassembled mode please add the index A1...A4 e.g. 3075. 34 PZB A1

**Strain relief for polymer mounting brackets (pivoting or locking)**

The strain relief tiewrap plates can be directly snapped onto the mounting bracket. After bolting the mounting brackets to the machine, the strain relief tiewrap plates are also firmly connected to the base. They do not need to be bolted on separately. Cable tiewraps secured the tiewrap plate "teeth" and the cable provide proper strain relief and save time. **Details ▶ chapter 10**

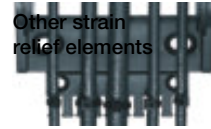

Tiewrap plate	No. of teeth <i>n</i>	Dim. C [mm]	Dim. B [mm]	Center bore
3050.ZB	5	50	30	-
3075.ZB	7	75	55	-
3100.ZB	10	100	80	-
3115.ZB	11	115	95	-
3125.ZB	12	125	105	-
3150.ZB	15	150	130	-
3175.ZB	17	175	155	-
3200.ZB	20	200	180	+
3225.ZB	22	225	205	+
3250.ZB	25	250	230	+

(- = no / + = yes)

**Tiewrap plate as individual part**

As individual component screwed on or can be plugged in the mounting brackets. **Details ▶ chapter 10**

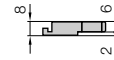
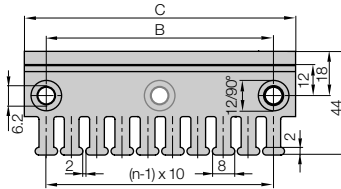

Single tiewrap plate

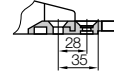

Shown assembled

**Cable tiewraps as individual part**

Cable tiewraps 100 pieces/bag	Width x length	Max. Ø	Tensile strength
CFB.001	4,8 x 150 mm	36 mm	222 N



Other strain relief elements - optional ▶ chapter 10

Easy Chain®  
Inner height: 48,5 mm

Phone +49- (0) 22 03-96 49-800  
Fax +49- (0) 22 03-96 49-222



▶ chapter 10



▶ page 3.5

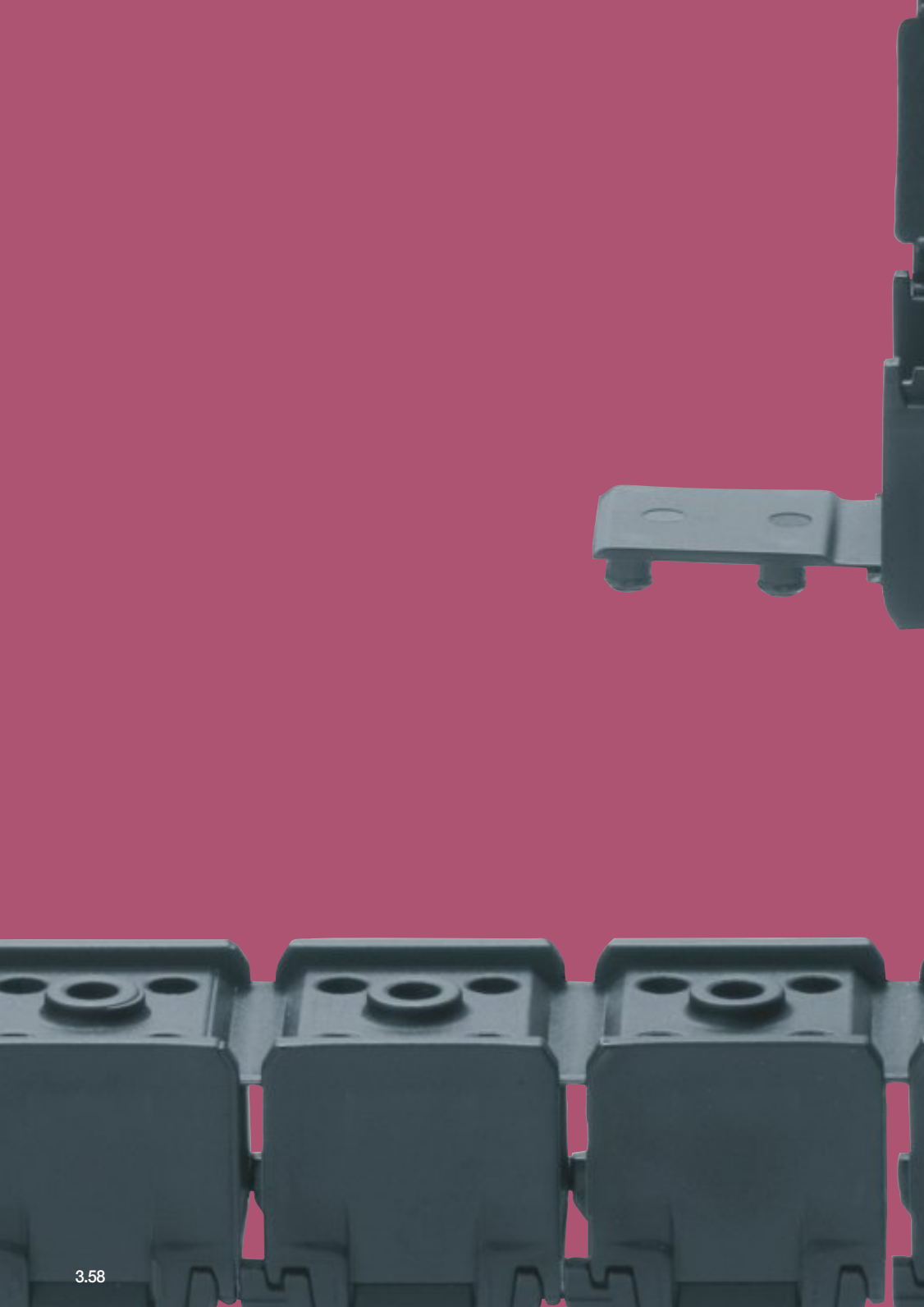

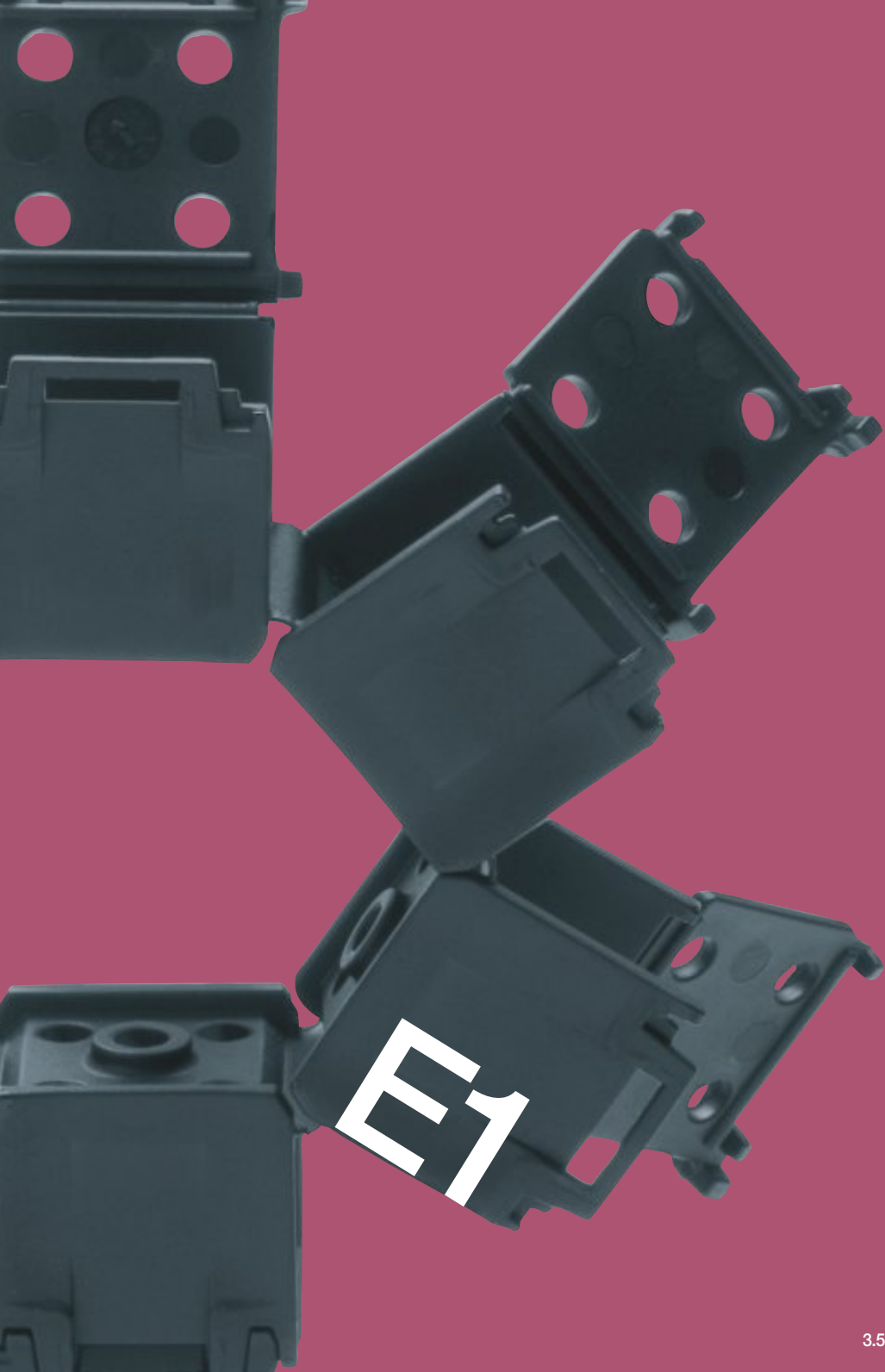



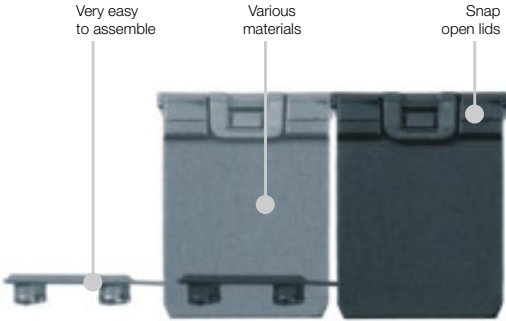

## Modular, 1-piece strip design for simple applications

- Economic solution for high volumes
- A universal and easily adaptable E-Chain® concept
- E1: E-Chain® on one strip
- Easy shortening/lengthening through molded-on, modular strip
- Easy to snap open
- Strip connectors
- Easy fixation at each end
- Various materials available
- You can find more technical data about the material, chemical resistance, temperatures ► **chapter design, from page 1.38**

### Opening-principle



Snap-open along outer radius

### Dimensioning

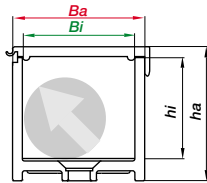

### Bending radius

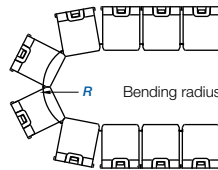

### Part No. structure

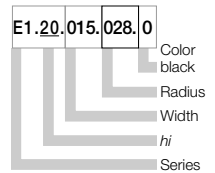

### Selection table

Series	Inner height <i>hi</i> [mm]	Inner width <i>Bi</i> [mm]	Outer width <i>Ba</i> [mm]	Outer height <i>ha</i> [mm]	Bending radius <i>R</i> [mm]	Length part [mm]	Page
E1.10.013.	10	13	16,5	15,5	28	200	3.64
E1.17.021.	17	21	26	25	28	255	3.64
E1.17.031.	17	31	36	25	28	204	3.64
E1.17.044.	17	44	49	25	28	255	3.64
E1.20.015.	20	15	22	27	28	250	3.64

### Comparison of the main characteristics

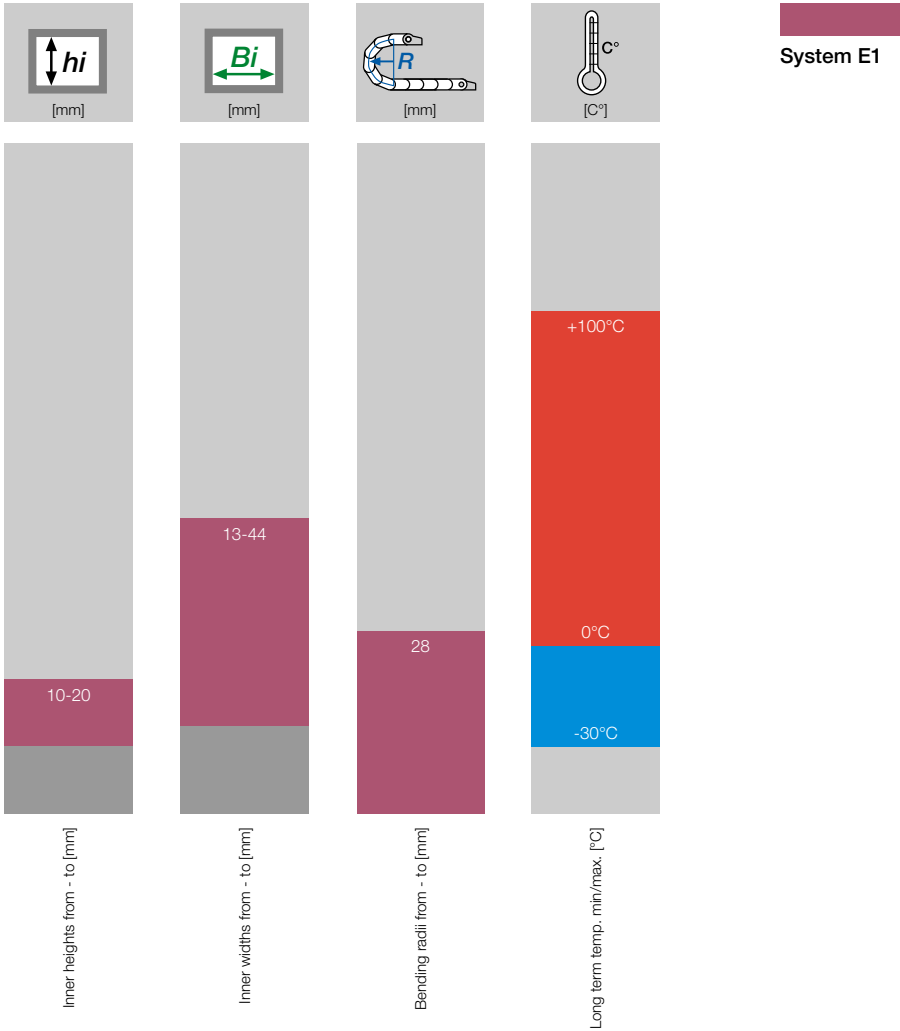

### Additional quality features - System E1



UL 94 - V2  
available on request

**E1: E-Chain® modular, 1-piece strip designed for simple applications** - The new E1 design brings the benefits of an E-Chain® to applications, where this solution previously was too expensive. E1 is more economic for higher volumes, quicker to assemble and still offers great control and protection for moving cables. **The igus®-System E1 is very cost effective for high volumes and is especially ideal for automotive applications.**

### Typical industries and applications

- Automotive
- Office Solutions and technology
- Automation
- Electric equipment
- Machine-building

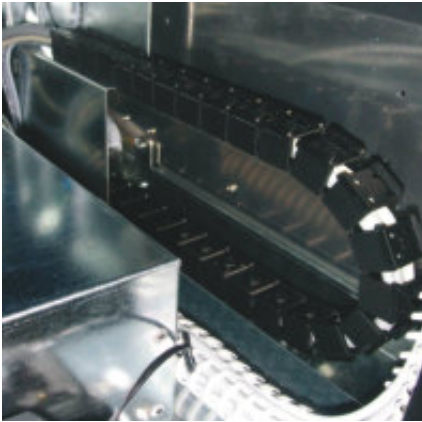

Harnessed igus® System E1 in a bottle deposit machine



Series igus® System E1 in an electric wheelchair - cably supply on the scissors lifting system



The igus®-System E1 is very cost-effective at high quantities and ideal for automotive applications



To shorten | System E1



System E1 - E-Chain® on one strip - easy to shorten....

To lengthen | System E1



.. and to lengthen



● ● ● Price index



UL94-V2 available  
on request

- ❶ Easy to shorten - separation at each segment
- ❷ Very easy to fill because of snap-open lids
- ❸ Easy to lengthen - strips can simply be snapped together
- ❹ Easy fastening through strip bore each link
- ❺ Low-price E-Chain®
- ❻ Different materials and colors available upon request
- ❼ Compact design with smooth outer contour
- ❽ Strain relief option (clip-on bracket)
- ❾ All lids snap open to the same side for easier, (Except E1.20.40 - to open from both sides), possibly automated closing

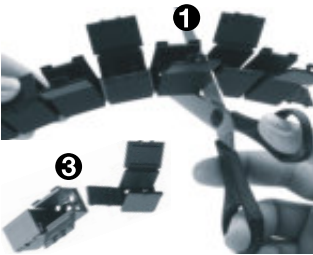
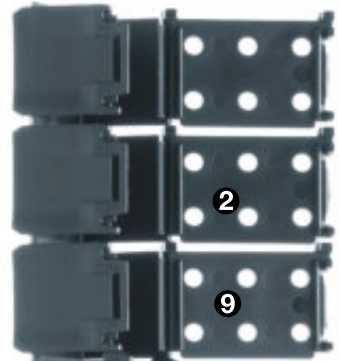

System E1 - E-Chain® on one strip - easy to shorten and to lengthen

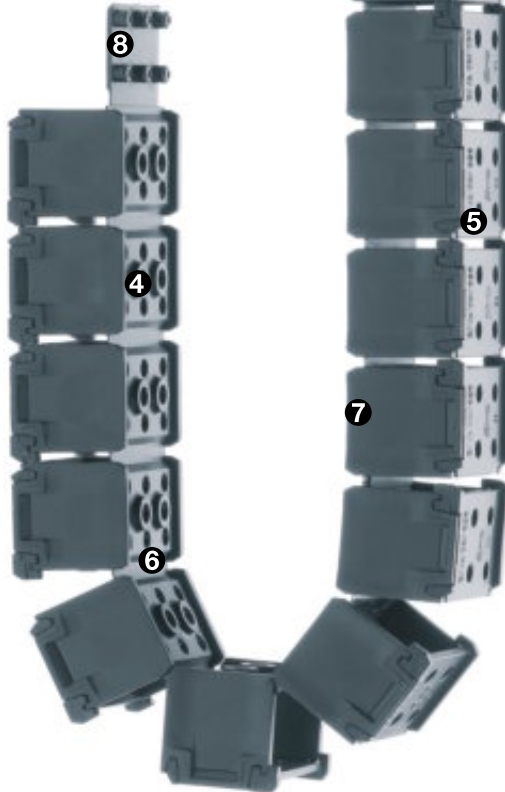

#### When to use the Series E1:

- If simple filling is required
- If an economical E-Chain® is required
- If small assembly cost is required
- For lower duty or cycle life



#### When not to use it:

- High load applications
  - ▶ Easy Chain®, this chapter
  - ▶ Zipper, chapter 4
- High cycle applications
  - ▶ Easy Chain®, this chapter
  - ▶ Zipper, chapter 4



#### Order example complete E-Chain®

Please indicate chain-lengths or number of links Example: 1 Band = 250 mm of length

1 m E1.17.021.028.0 (= 4 x 255 mm Band)



E-Chain®

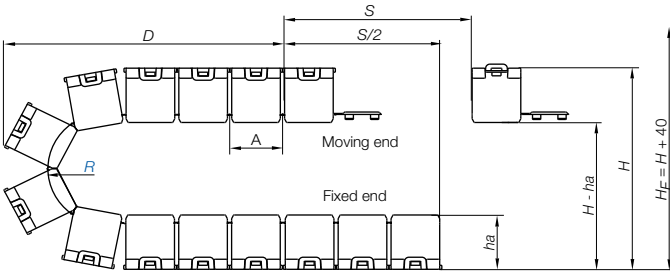

- S = Length of travel
- R = Bending radius
- H = Nominal clearance height
- H<sub>F</sub> = Required clearance height
- D = Overlength E-Chain\* radius in final position
- K = π · R + "safety"

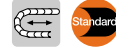

### Short travels - unsupported

Unsupported E-Chains\* feature positive camber over short travels. This must be accounted for when specifying the clearance height H<sub>F</sub>. Please consult igus® if space is particularly restricted.

Pitch = see Dim. A    Length part = see Dim. B    Chain length =  $S/2 + K$

Bending radius for Series: E1.10		E1.17	E1.20
R	028	028	028
H	82	102	102
D	66	76	76
K	140	140	140

The required clearance height is  $H_F = H + 40$  mm · More radii upon request!

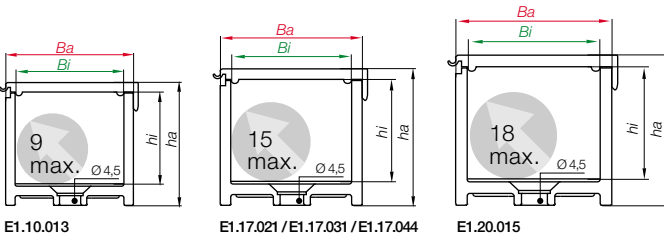

### Product Range - Series E1 - snap-open along outer radius

Part No.	Bi [mm]	Ba [mm]	hi [mm]	ha [mm]	R [mm] Bending radii	A [mm]	B [mm]
E1.10.013.□.0	13	16,5	10	15,5	028	20	200
E1.17.021.□.0	21	26	17	25	028	25,5	255
E1.17.031.□.0	31	36	17	25	028	25,5	204
E1.17.044.□.0	44	49	17	25	028	25,5	255
E1.20.040.□.0*	15	22	20	27	028	25	250

\*E1.20.040 - Lids to open reciprocal

Supplement Part No. with required radius. Example: E1.17.021.028.0

0 = standard color, other colors ▶ page 1.39 · Pitch = 25 mm/link - Links/m = 40

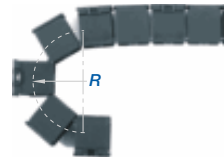

Part No. structure

E1.17.021.028.0

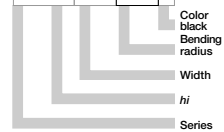

System E1  
Inner height: 10, 17, 20 mm

Tel. +49- (0) 22 03-96 49-800  
Fax +49- (0) 22 03-96 49-222





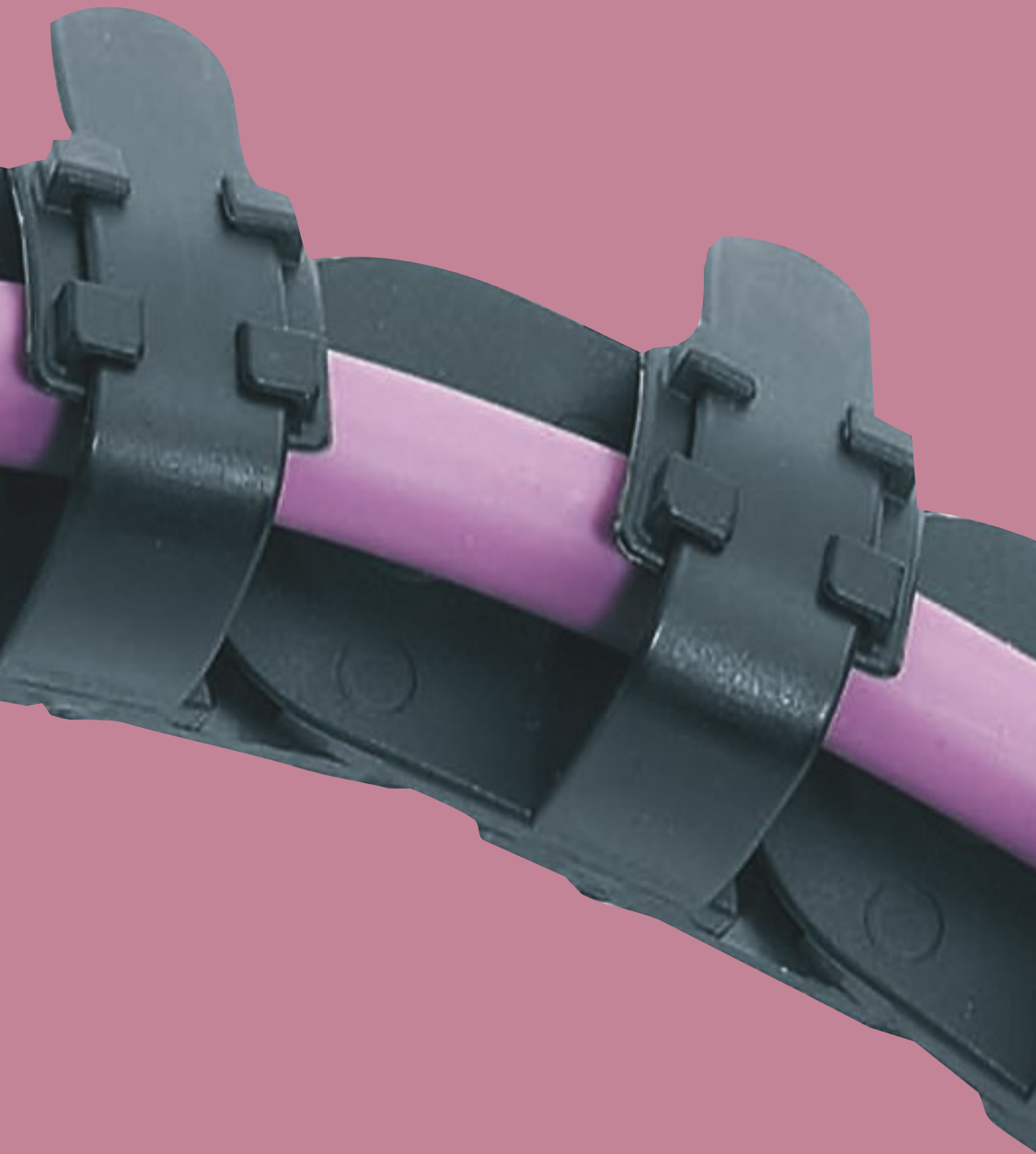

# SnapChain

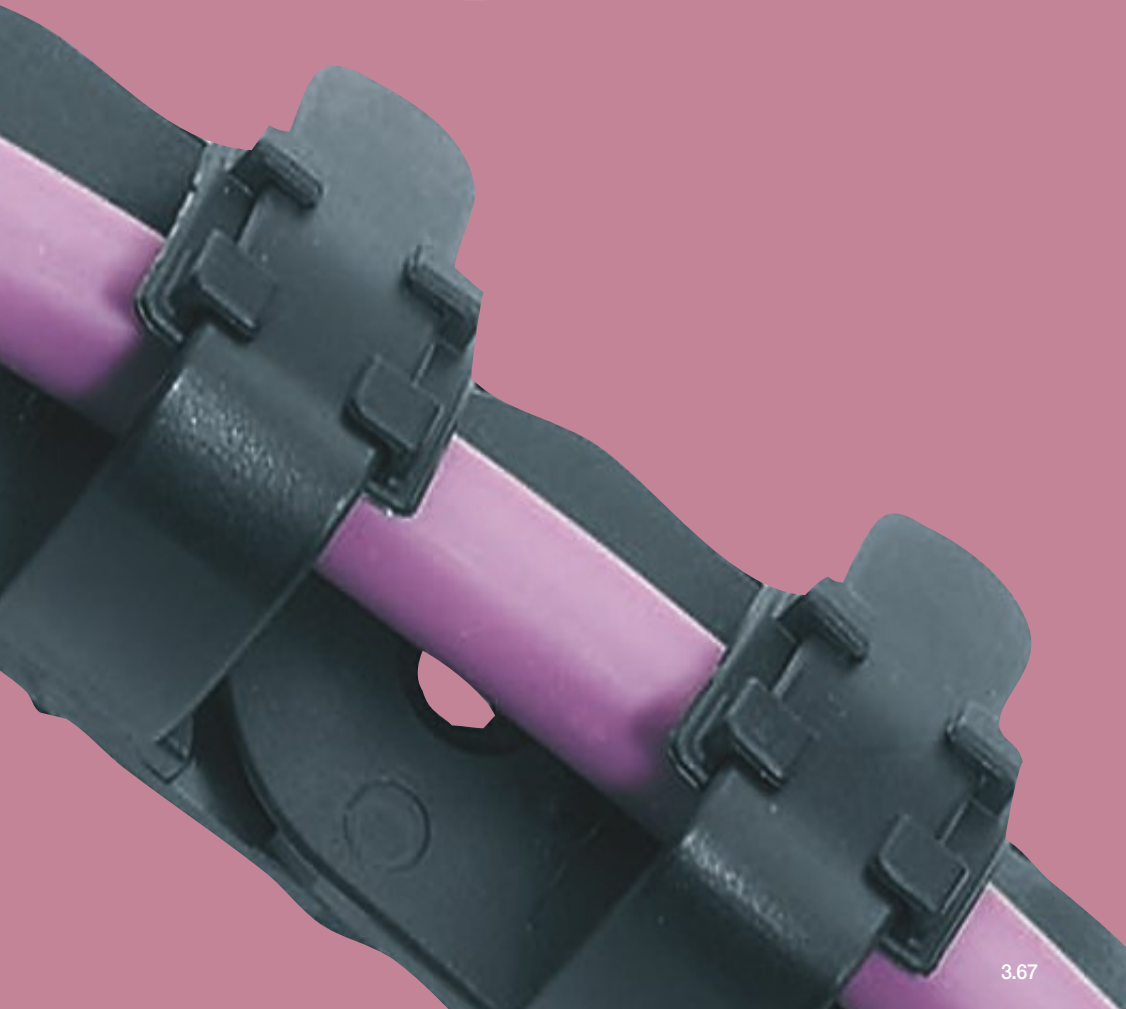



Price index



iF-Design-Award  
for SnapChain-Design

### Typical industries and applications

- Switch cubicle construction
- Electrical equipment
- Computer cubicles
- Office furniture
- Wherever cables are moved now and then

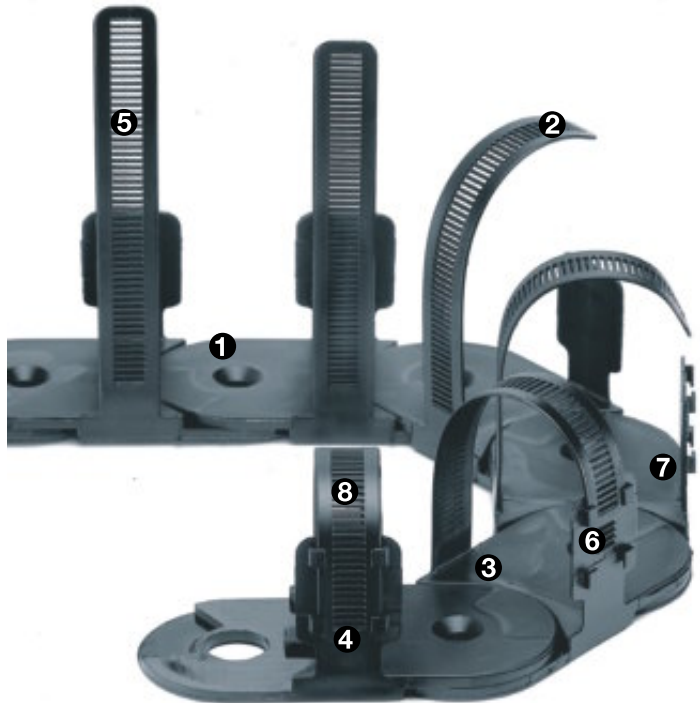

- ① Fit cable assemblies quickly in bunches
- ② Adjust and change loops at any time
- ③ Well-suited to short lengths, ideally 5 - 10 links
- ④ Favorable alternative to complex hinged cable trays
- ⑤ Version TE can be opened along outer radius - Version TZ along inner radius
- ⑥ Elegant design
- ⑦ Can be bent in 1 or 2 directions
- ⑧ Available in 2 sizes



#### When to use the SnapChain Series :

- If simple filling is required
- If an economical e-chain is required
- If small assembly cost is required
- If an easy solution is required
- For minor number of travels



#### When not to use it:

- High load applications
  - ▶ Easy Chain®, this chapter
  - ▶ Zipper, chapter 4
- High cycle applications
  - ▶ Easy Chain®, this chapter
  - ▶ Zipper, chapter 4



#### Order example complete E-Chain®

Please indicate chain-lengths or number of links Example: 1 m or 18 links

1 m TE26.120.100.0



E-Chain®

### SnapChain - TE14 / TZ14 - to be opened

Part No.	R [mm]	Bending radii					
TE14.50.□.0*	<input type="text" value="028"/>	<input type="text" value="038"/>	<input type="text" value="048"/>	<input type="text" value="075"/>	<input type="text" value="100"/>	<input type="text" value="125"/>	
TZ14.50.□.0	<input type="text" value="028"/>	<input type="text" value="038"/>	<input type="text" value="048"/>	<input type="text" value="075"/>	<input type="text" value="100"/>	<input type="text" value="125"/>	

\*Available as RBR (Reverse bending radius) Part No. TE14.50.Radius/Radius

Part No. structure

TE14.	50.	100.0
-------	-----	-------



Supplement Part No. with required radius. Example: TE14.50.100.0

0 = standard color, other colors ▶ page 1.39 - Pitch = 30,5 mm/link - Links/m = 18

Pitch = 30,5 mm

Links/m = 33 (1.006,5 mm)

Chain length =  $s_2 + K$

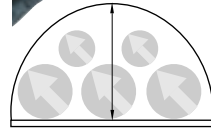
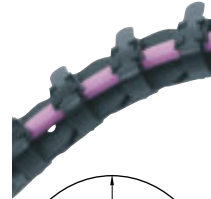
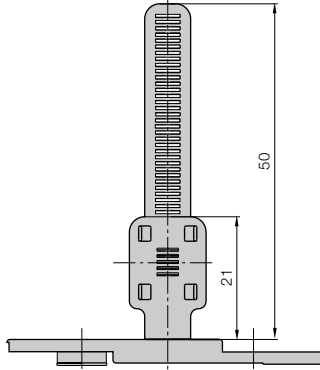
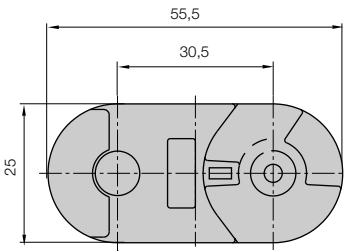

Cable package max.: 18 mm

### SnapChain - TE26 / TZ26 - to be opened

Part No.	R [mm]	Bending radii					
TE26.120.□.0*	<input type="text" value="063"/>	<input type="text" value="075"/>	<input type="text" value="100"/>	<input type="text" value="125"/>	<input type="text" value="150"/>	<input type="text" value="200"/>	
TZ26.120.□.0	<input type="text" value="063"/>	<input type="text" value="075"/>	<input type="text" value="100"/>	<input type="text" value="125"/>	<input type="text" value="150"/>	<input type="text" value="200"/>	

\*Available as RBR (Reverse bending radius) Part No. TE26.120.Radius/Radius

Part No. structure

TE26.	120.	100.0
-------	------	-------



Supplement Part No. with required radius. Example: TE26.120.100.0

0 = standard color, other colors ▶ page 1.39 - Pitch = 56 mm/link - Links/m = 18

Pitch = 56 mm

Links/m = 18 (1.008 mm)

Chain length =  $s_2 + K$

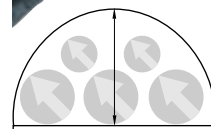
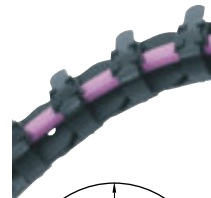
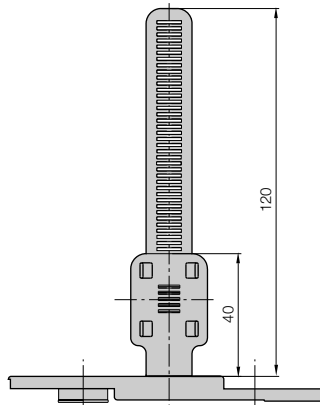
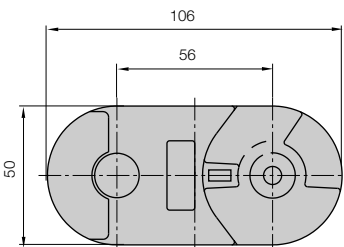

Cable package max.: 47 mm



# Zipper

zip-open principle



CHAINFLEX

igus

igus

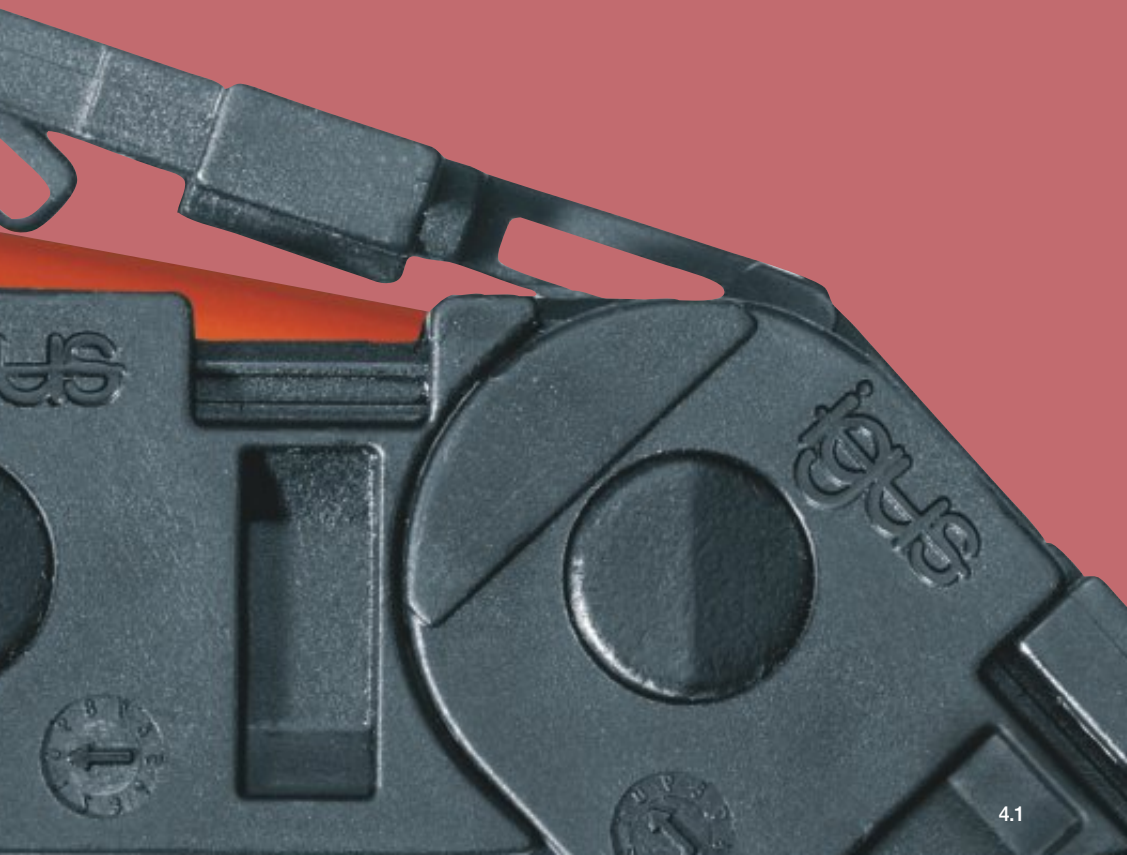



# igus® Zipper | Fast opening and closing with "Zipper"

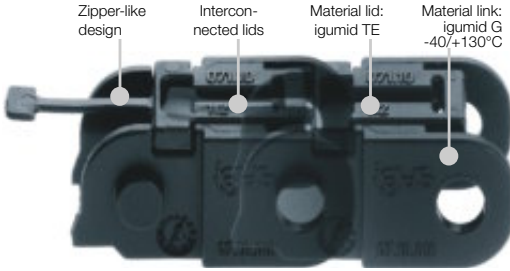

## Zipper E-Chains®

- Reduced assembly-time: Zipper-like design for quick opening and closing of lids
- Zipper lids can be separated and joined at each chain link
- Small pitch for low noise, smooth operation
- High acceleration: 100 m/s<sup>2</sup> and more
- Interior separation possible for larger versions
- You can find more technical data about the material, chemical resistance, temperatures ► [chapter design, from page 1.38](#)

### Opening-principle



### Dimensioning

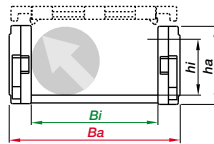

### Bending radius

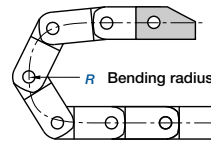

### Part No. structure

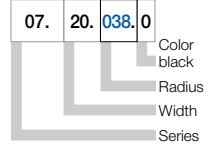

### Selection table

Series	Inner height <i>hi</i> [mm]	Inner width <i>Bi</i> [mm]	Outer width <i>Ba</i> [mm]	Outer height <i>ha</i> [mm]	Bending radius <i>R</i> [mm]	Unsupported length max. [m]	Page
047	9,0	10 - 16	16,0 - 22,0	12,5	18 - 38	0,40	4.6
07	10,3	6 - 64	12,5 - 71,0	15,0	18 - 38	0,55	4.10
09	15,0	10 - 50	18,2 - 58,2	19,3	28 - 48	1,00	4.14
15	17,0	15 - 100	26,0 - 113,0	24,0	38 - 180	1,20	4.18
17	32,0	15 - 100	26,0 - 113,0	39,0	63 - 125	1,00	4.24

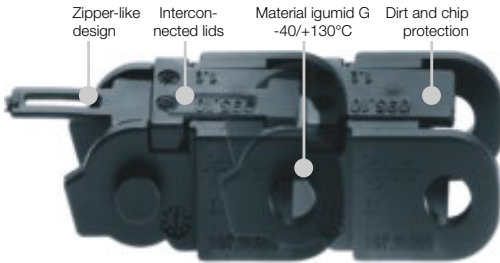

## Zipper E-Tubes against chips and dirt

- Fully enclosed E-Tube with zipper opening mechanism
- Protection against dirt and chips
- Superfast opening of interconnected lids
- Modular design - tool-free lengthening and shortening
- Small pitch for low noise, smooth operation, high acceleration
- You can find more technical data about the material, chemical resistance, temperatures ► [chapter design, from page 1.38](#)

### Opening-principle



### Dimensioning

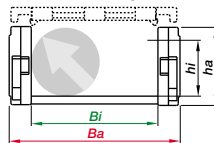

### Bending radius

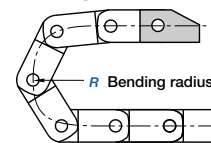

### Part No. structure

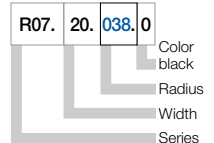

### Selection table

Series	Inner height <i>hi</i> [mm]	Inner width <i>Bi</i> [mm]	Outer width <i>Ba</i> [mm]	Outer height <i>ha</i> [mm]	Bending radius <i>R</i> [mm]	Unsupported length max. [m]	Page
R07	10,3	10 - 50	16,5 - 57,0	15,0	38 - 48	0,55	4.28
R09	15,0	10 - 50	18,2 - 58,2	19,3	48 - 100	1,00	4.32
R15	17,0	15 - 100	26,0 - 113,0	24,0	63 - 180	1,20	4.36
R17	32,0	15 - 100	26,0 - 113,0	39,0	63 - 125	1,20	4.42

### Comparison of the main characteristics

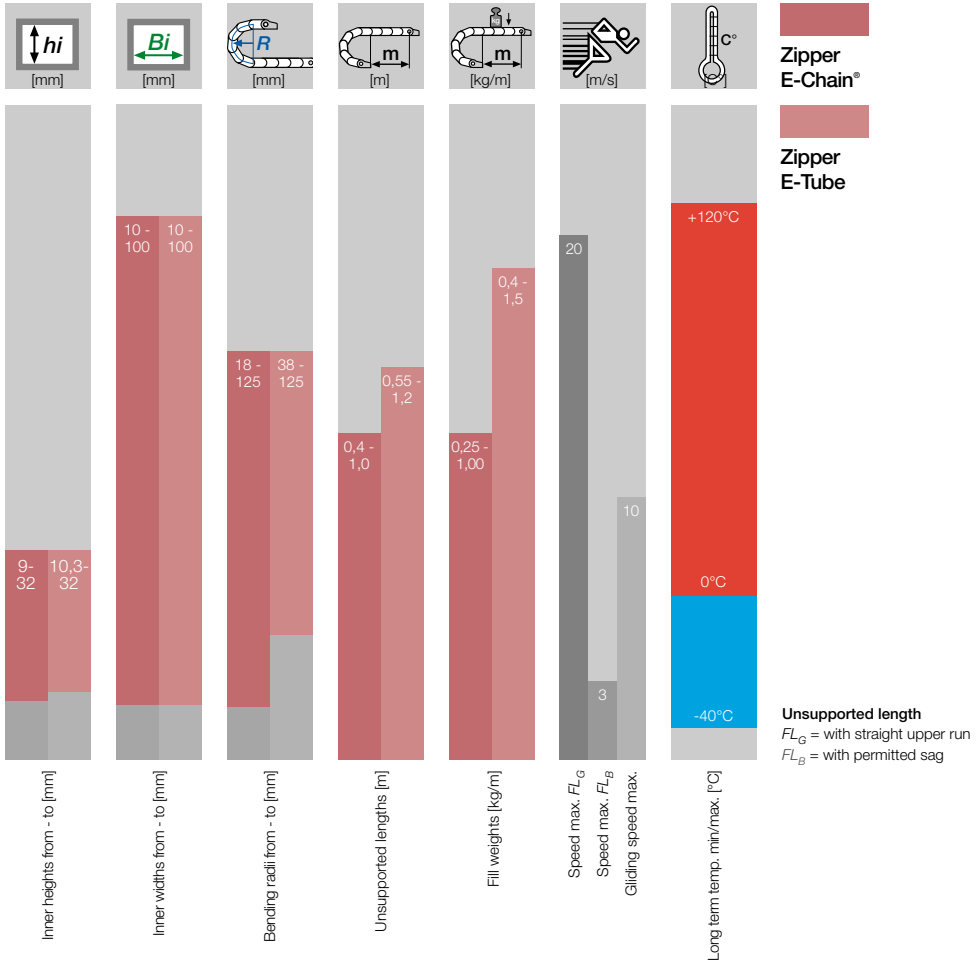

### Additional quality features - Zipper

- Cleanroom Class 1 (ISO class 3) for Zipper Series 15, tested by the Dryden Engineering Company, California
- UL94-V2 classifications upon request
- iF-Design Award Winner
- Low-noise
- Fast Opening and Closing with "Zipper"

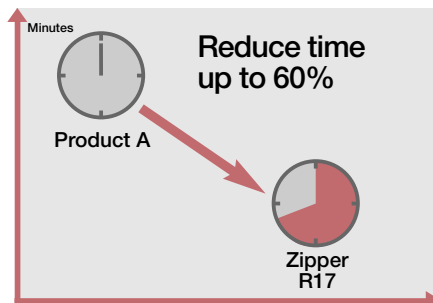

Assembly time: Opening from 1m Chain - We can present you with more Details about this and other tests

**Lightning-fast opening and closing with Zipper E-Chains® and E-Tubes** - "Zipper" E-Chains® convince in practicality and performance. The "Zipper" function makes them a very useful product to reduce assembly time. The small pitch, the tough-elastic zipper-band, and the sturdy link work wonders in high-acceleration environments. The "Zipper" Series is one of the most popular E-Chain® Series in demanding industries.

**Typical industries and applications**

- Pick and place robots
- Semiconductor machines
- Linear motors, actuators
- Machinery of all kinds
- Measuring equipment
- Machine Tools (Zipper-E-Tube)
- Material handling



igus® E-Chain® Series 15 Zipper in automatic equipment - reduce assembly time

 iF-Design award  
Zipper Series R09

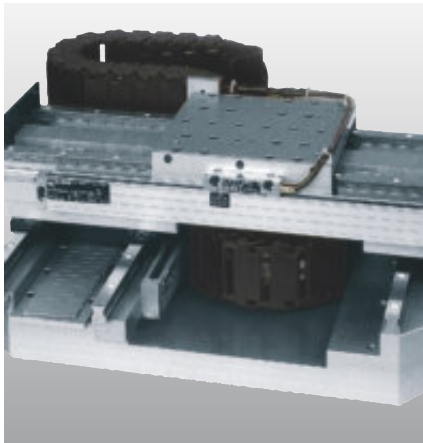

igus® E-Chain® Series 17 on an X-Y table.  
Acceleration: 100 m/s<sup>2</sup>

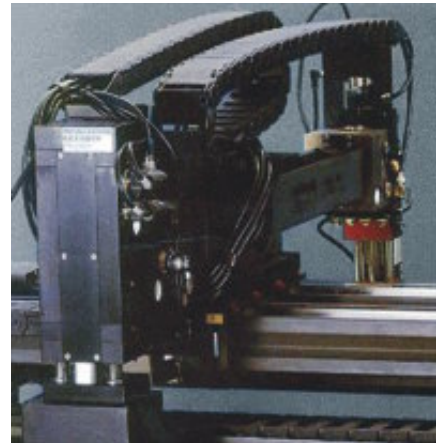

Series 15 with acceleration of 100 m/s<sup>2</sup> on pick-and-place robots, low noise

Assembling | Zipper

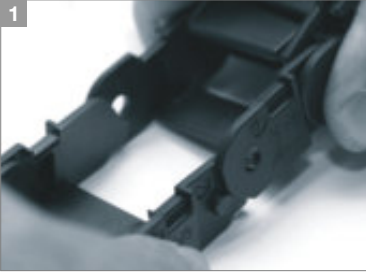

1 Push and click



2 Snap lids together



3 Position and...



4 ...push and snap

Separate | Zipper



1 Zipp - upward . All lids fit like a "Zipper"



2 Separate lids



3 Release side-link



4 Twist and pull apart



● ● ● Price index



Upon request: Cleanroom Class 1 (ISO class 3) tested by the Dryden Engineering Company, California



UL94-V2 classifications upon request



Low-noise



"Zipper-fast" opening and closing



#### When to use the Series 047:

- If fast, zipper-like accessibility to cables is required
- If quiet operation is required
- If aesthetic design is required
- If excellent service life is required
- If cost is a factor



#### When not to use it:

- If easy filling without opening and closing is required
- ▶ Series E04 Easy Chain®, page 3.10

- ❶ Small pitch for low-noise, smooth operation
- ❷ For high acceleration
- ❸ "Zipper-fast" opening and closing
- ❹ Zipper lids can be separated and joined at each chain link
- ❺ Light weight
- ❻ Mounting brackets available

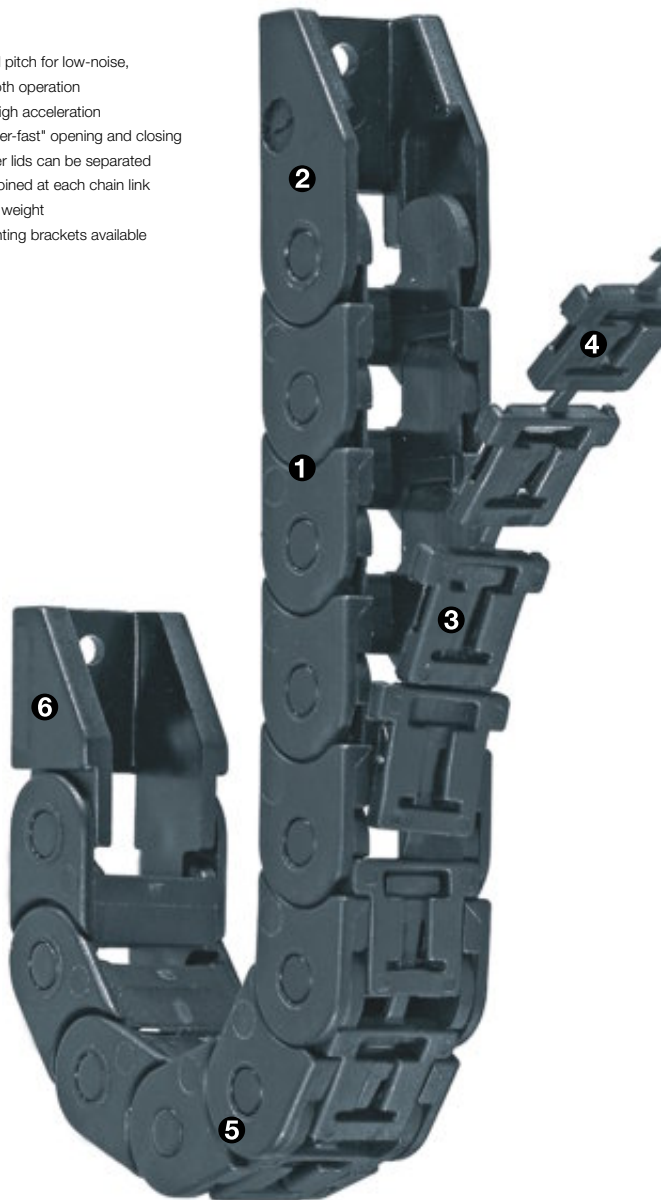

#### Order example complete E-Chain®

Please indicate chain-lengths or number of links Example: 1 m or 77 Links

1 m 047.10.038.0



E-Chain®

1 set 0450.10.12



Mounting bracket

**Unsupported length**

$FL_G$  = with straight upper run

$FL_B$  = with permitted sag

Further information ► Design, page 1.12

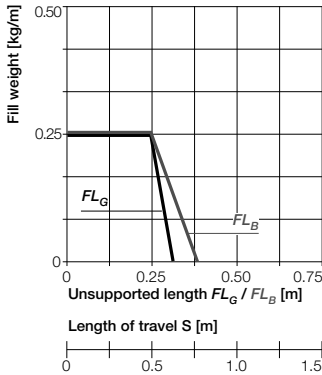
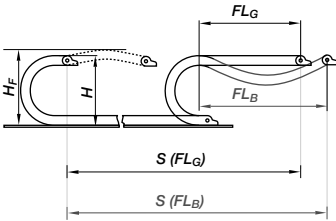

- $S$  = Length of travel
- $R$  = Bending radius
- $H$  = Nominal clearance height
- $H_F$  = Required clearance height
- $D$  = Overlength E-Chain® radius in final position
- $K = \pi \cdot R + \text{"safety"}$

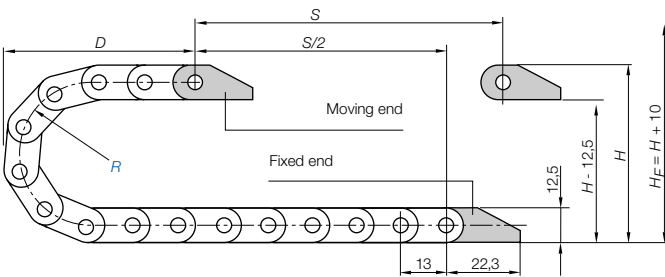

Pitch = 13 mm/link    Links/m = 77 (1.001 mm)    Chain length =  $S/2 + K$

$R$	018	028	038
$H$	52	72	92
$D$	45	55	65
$K$	100	140	160

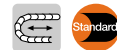

**Short travels - unsupported**

Unsupported E-Chains® feature positive camber over short travels. This must be accounted for when specifying the clearance height  $H_F$ . Please consult igus® if space is particularly restricted.

The required clearance height:  
 $H_F = H + 10$  mm  
 (with 0,2 kg/m fill weight)



Zipper E-Chains®  
 Inner height: 9 mm

Phone +49- (0) 22 03-96 49-800  
 Fax +49- (0) 22 03-96 49-222



**Chainflex® CF98 - tested 30 million strokes with 4xd**

TPE outer jacket, oil- and bio-oil-resistant, PVC and halogen-free, low-temperature-flexible  
 Further information: [www.igus.de/en/CF98](http://www.igus.de/en/CF98)



Speed / acceleration $FL_G$	max. 20 [m/s] / max. 200 [m/s]
Speed / acceleration $FL_B$	max. 3 [m/s] / max. 6 [m/s]
Gliding speed / acceleration (maximum)	max. 10 [m/s] / max. 50 [m/s]
Material - permitted temperature °C	igumid G / -40° to +130° C
Flammability class, igumid G	VDE 0304 IIC UL94 HB

**Technical Data**



Details of material properties  
 ► page 1.38



► page 4.5



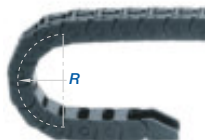
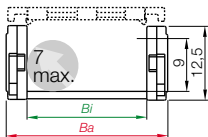

Series 047 E-Chain® - zip-open along outer radius

Part No.	Bi [mm]	Ba [mm]	R [mm]	Bending Radii	Weight [kg/m]
047.10.□.□.0	10	16	018	028 038	~ 0,10
047.16.□.□.0	16	22	018	028 038	~ 0,11

Supplement part no. with required radius (R) Example: 047.10.038.0

0 = standard color, other colors ▶ page 1.39 · Pitch = 13 mm/link - Links/m = 77

Part No. structure

047. 10. 038. 0



E-Chains® side by side as individual or "multiband" - Series Zipper



**Polymer, one-piece**

- One-piece mounting bracket
- Corrosion-resistant
- Available preassembled
- Various installation conditions possible

Moving end with bore  
(outer link) 0450...1

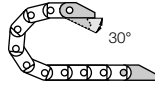

0450...2 Fixed end  
with pin (inner link)



Possible installation conditions for assembled mounting brackets ▶ Order example "preassembled" below

0450...1  
Moving end

0450...2  
Fixed end

**Dimensions and order configurations**

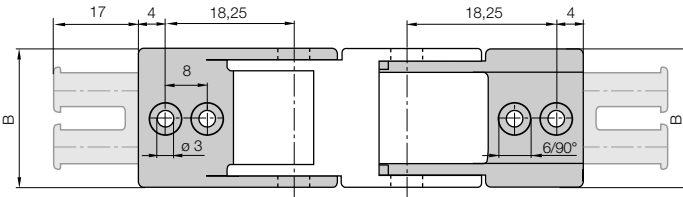

For E-chain®	Part No. full set with tiewrap plate	Part No. full set without tiewrap plate	Number of teeth	Dim. B [mm]
047.10. ▶	0450.10. 12 PZ	0450.10. 12	1	16
047.16. ▶	0450.16. 12 PZ	0450.16. 12	2	22

For the preassembled mode please add the index **A2** and **A4** Example: 0450.10. 12 **A2**

**Part No. structure**

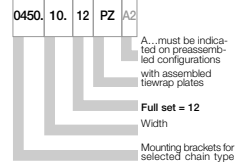

Full set, for both ends:

0450. 10. 12

Single-part order:

0450. 10. 1

Mounting bracket with bore

0450. 10. 2

Mounting bracket with pin

Phone +49- (0) 22 03-96 49-800  
Fax +49- (0) 22 03-96 49-222



**Quicksnap** - the complete, detachable mounting unit, available upon request

**Quickfix** - mounting bracket with dowel, available upon request

**Additional Features**



● ● ● Price index

Clean-Room

Upon request: Cleanroom Class 1  
(ISO class 3) tested by the Dryden  
Engineering Company, California

UL

UL94-V2 classifications  
upon request



Low-noise



"Zipper-fast" opening and closing



When to use the Series 07:

- If fast, zipper-like accessibility to cables is required
- If quick, easy insertion of cables with preassembled connectors is required
- If quieter operation is required
- If aesthetic design is required
- At high acceleration and travel speed



When not to use it:

- If opening of the link is not necessary
  - ▶ Series 06 E2 micro, page 5.26
- If cable installation without opening lids is possible
  - ▶ Series E06 Easy Chain®, page 3.20
- If a closed tube system is required
  - ▶ Series R07, page 4.28

- ① "Zipper-fast" opening and closing
- ② Small pitch for low-noise, smooth operation
- ③ For high acceleration
- ④ Zipper lids can be separated and joined at each chain link
- ⑤ Light weight
- ⑥ Mounting bracket with integrated strain relief
- ⑦ Also available as "Zipper" E-Tube Series R07 ▶ page 4.28



Order example complete E-Chain®

Please indicate chain-lengths or number of links Example: 1 m or 50 links

1 m 07.20.038.0



E-Chain®

1 set 060.20.12PZ



Mounting bracket

**Unsupported length**

$FL_G$  = with straight upper run

$FL_B$  = with permitted sag

Further information ► Design, page 1.12

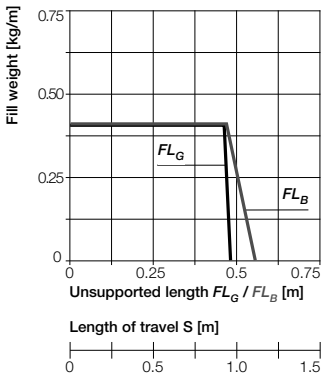
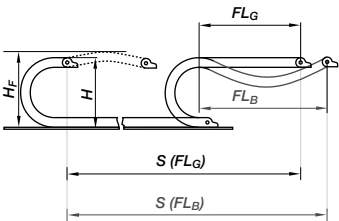

- $S$  = Length of travel
- $R$  = Bending radius
- $H$  = Nominal clearance height
- $H_F$  = Required clearance height
- $D$  = Overlength E-Chain® radius in final position
- $K = \pi \cdot R + \text{"safety"}$

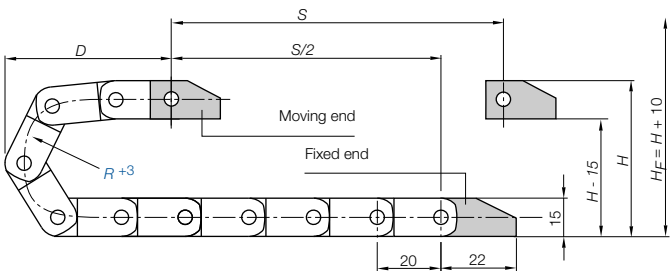

Pitch = 20 mm/link    Links/m = 50 (1.000 mm)    Chain length =  $S/2 + K$

$R$	018	028	038
$H$	52	72	92
$D$	45	55	65
$K$	100	140	160



**Short travels - unsupported**

Unsupported E-Chains® feature positive camber over short travels. This must be accounted for when specifying the clearance height  $H_F$ . Please consult igus® if space is particularly restricted.

The required clearance height:  
 $H_F = H + 10$  mm  
 (with 0,2 kg/m fill weight)

10,3

Zipper E-Chains®  
 Inner height: 10,3 mm

Phone +49- (0) 22 03-96 49-800  
 Fax +49- (0) 22 03-96 49-222



**Chip protection**

Fully enclosed E-Tube with zipper opening mechanism ● Protection against dirt and chips ● Superfast opening of interconnected lids ● Modular design - tool-free lengthening and shortening ● Small pitch for low noise, smooth operation, high acceleration  
**Zipper E-Tube R07, inner height 10,3 mm ► from page 4.28**



Speed / acceleration $FL_G$	max. 20 [m/s] / max. 200 [m/s]
Speed / acceleration $FL_B$	max. 3 [m/s] / max. 6 [m/s]
Gliding speed / acceleration (maximum)	max. 10 [m/s] / max. 50 [m/s]
Material - permitted temperature °C	igumid G / -40° to +130° C
Flammability class, igumid G	VDE 0304 IIC UL94 HB

**Technical Data**



Details of material properties  
 ► page 1.38



► page 4.5

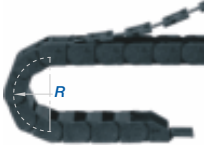
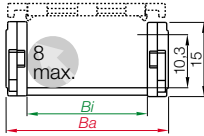

Part No. structure

07.	20.	038.	0
-----	-----	------	---



Color  
black  
Bending  
radius  
Width  
Series

## Series 07 E-Chain® - zip-open along outer radius

Part No.	Bi [mm]	Ba [mm]	R [mm]	Bending Radii			Weight [kg/m]
07.06.□.0	06	12,5	018	028	038	~ 0,13	
07.10.□.0	10	16,5	018	028	038	~ 0,14	
07.16.□.0	16	22,5	018	028	038	~ 0,16	
07.20.□.0	20	27	018	028	038	~ 0,17	
07.30.□.0	30	37	018	028	038	~ 0,20	
07.40.□.0	40	47	018	028	038	~ 0,23	
07.50.□.0	50	57	018	028	038	~ 0,26	
07.64.□.0	64	71	018	028	038	~ 0,30	

Supplement part no. with required radius (R) Example: 07.20.□038□.0

0 = standard color, other colors ► page 1.39 · Pitch = 20 mm/link - Links/m = 50



Phone +49- (0) 22 03-96 49-800  
Fax +49- (0) 22 03-96 49-222

igus® GmbH  
51147 Cologne

Internet: www.igus.de  
E-mail: info@igus.de



**Polymer, one-piece**

- One-piece mounting bracket
- Corrosion-resistant
- Available preassembled
- Inner and outer attachment possible
- Available with or without integrated strain relief tiwrap plates

Moving end with bore (outer link) 060...1(PZ)

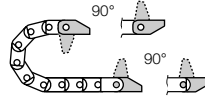

060...2(PZ) Fixed end with pin (inner link)

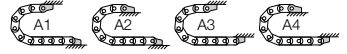

Possible installation conditions for assembled mounting brackets ▶ Order example "preassembled" below

060...1(PZ)

Moving end

060...2(PZ)

Fixed end

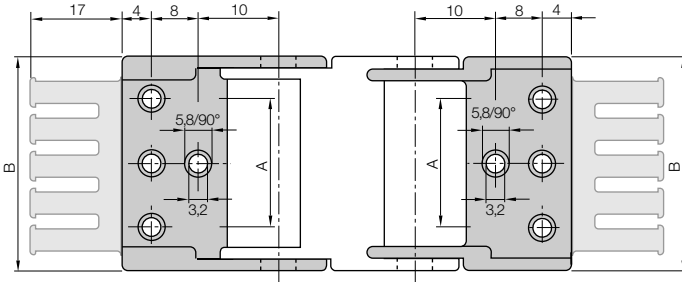

060.06.12 - 060.20.12: center bores only

060.30.12 - 060.64.12: outer bores only

For E-chain*	Part No. full set with tiwrap plate	Part No. full set without tiwrap plate	Number of teeth	Dim. A [mm]	Dim. B [mm]
07.06. ▶	060.06. 12 PZ	060.06. 12	1	-	12,5
07.10. ▶	060.10. 12 PZ	060.10. 12	1	-	16,5
07.16. ▶	060.16. 12 PZ	060.16. 12	2	-	22,5
07.20. ▶	060.20. 12 PZ	060.20. 12	2	-	27,0
07.30. ▶	060.30. 12 PZ	060.30. 12	3	22	37,0
07.40. ▶	060.40. 12 PZ	060.40. 12	4	32	47,0
07.50. ▶	060.50. 12 PZ	060.50. 12	5	42	57,0
07.64. ▶	060.64. 12 PZ	060.64. 12	6	56	71,0

For the preassembled mode please add the index [A1] ... [A4] Example: 060.06. 12 PZ [A1]

**Dimensions and order configurations**

Strain relief is possible on the moving end and/or the fixed end.

**Part No. structure**

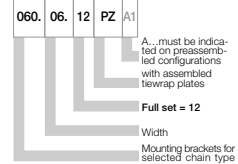

Full set, for both ends:

060.06. 12 PZ +tiwrap plate

Single-part order:

060.06. 1 PZ +tiwrap plate

Mounting bracket with bore

060.06. 2 PZ +tiwrap plate

Mounting bracket with pin



**Quicksnap** - the complete, detachable mounting unit, available upon request

**Quickfix** - mounting bracket with dowel, available upon request

**Additional Features**

Phone +49- (0) 22 03-96 49-800  
Fax +49- (0) 22 03-96 49-222





● ● ● Price index

Clean-Room

Upon request: Cleanroom Class 1 (ISO class 3) tested by the Dryden Engineering Company, California

UL94-V2 classifications upon request

UL94-V2 classifications upon request



Low-noise



"Zipper-fast" opening and closing



#### When to use the Series 09:

- If fast, zipper-like accessibility to cables is required
- If quick, easy insertion of cables with preassembled connectors is required
- If quiet operation is required
- If aesthetic design is required
- At high acceleration and travel speed



#### When not to use it:

- If opening of the link is not necessary
  - ▶ Series 08 E2 micro, page 5.30
- If cable installation without opening lids is possible
  - ▶ Series E08 Easy Chain®, page 3.28
- If a closed tube system is required
  - ▶ Series R09, page 4.32

- ① "Zipper-fast" opening and closing
- ② For high acceleration
- ③ Small pitch for low-noise, smooth operation
- ④ Zipper lids can be separated and joined at each chain link
- ⑤ Light weight
- ⑥ Mounting bracket with integrated strain relief
- ⑦ Also available as "Zipper" E-Tube Series R09 ▶ page 4.32



#### Order example complete E-Chain®

Please indicate chain-lengths or number of links Example: 1 m or 50 links

1 m 09.20.038.0



E-Chain®

1 set 080.20.12PZ



Mounting bracket

**Unsupported length**

$FL_G$  = with straight upper run

$FL_B$  = with permitted sag

Further information ► Design, page 1.12

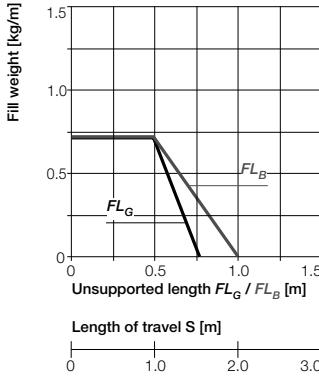
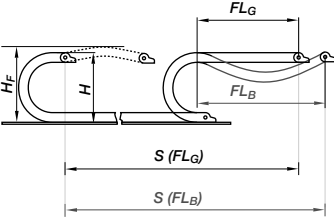

- $S$  = Length of travel
- $R$  = Bending radius
- $H$  = Nominal clearance height
- $H_F$  = Required clearance height
- $D$  = Overlength E-Chain® radius in final position
- $K = \pi \cdot R + \text{"safety"}$

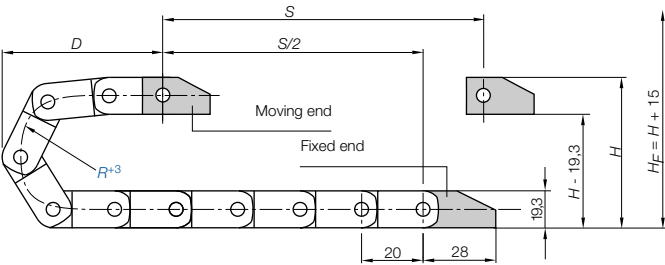

Pitch = 20 mm/link   Links/m = 50 (1.000 mm)   Chain length =  $S/2 + K$

$R$	028	038	048
$H$	76	96	116
$D$	60	70	80
$K$	130	160	190

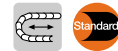

**Short travels - unsupported**

Unsupported E-Chains® feature positive camber over short travels. This must be accounted for when specifying the clearance height  $H_F$ . Please consult igus® if space is particularly restricted.

The required clearance height:  
 $H_F = H + 15 \text{ mm}$   
 (with 0,3 kg/m fill weight)

**Chip protection**

Fully enclosed E-Tube with zipper opening mechanism ● Protection against dirt and chips ● Superfast opening of interconnected lids ● Modular design - tool-free lengthening and shortening ● Small pitch for low noise, smooth operation, high acceleration  
**Zipper E-Tube R09, inner height 15 mm ► from page 4.32**



Speed / acceleration $FL_G$	max. 20 [m/s] / max. 200 [m/s]
Speed / acceleration $FL_B$	max. 3 [m/s] / max. 6 [m/s]
Gliding speed / acceleration (maximum)	max. 10 [m/s] / max. 50 [m/s]
Material - permitted temperature °C	igumid G / -40° to +130° C
Flammability class, igumid G	VDE 0304 IIC UL94 HB

**Technical Data**



Details of material properties  
 ► page 1.38



Zipper E-Chains®  
 Inner height: 15 mm

Phone +49- (0) 22 03-96 49-800  
 Fax +49- (0) 22 03-96 49-222



► page 4.5

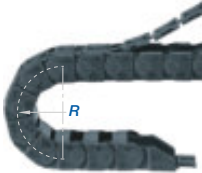
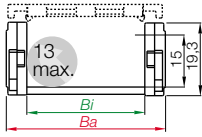

Part No. structure

09. 20. 038. 0



Color  
black  
Bending  
radius  
Width  
Series

## Series 09 E-Chain® - zip-open along outer radius

Part No.	Bi [mm]	Ba [mm]	R [mm]	Bending Radii			Weight [kg/m]
09.10.□.0	10	18,2	028	038	048	~ 0,21	
09.16.□.0	16	24,2	028	038	048	~ 0,24	
09.20.□.0	20	28,2	028	038	048	~ 0,25	
09.30.□.0	30	38,2	028	038	048	~ 0,28	
09.40.□.0	40	48,2	028	038	048	~ 0,31	
09.50.□.0	50	58,2	028	038	048	~ 0,34	

Supplement part no. with required radius (R) Example: 09.20.□038.0

0 = standard color, other colors ► page 1.39 · Pitch = 20 mm/link - Links/m = 50



Phone +49- (0) 22 03-96 49-800  
Fax +49- (0) 22 03-96 49-222

igus® GmbH  
51147 Cologne

Internet: www.igus.de  
E-mail: info@igus.de



Zipper E-Chains® e.g. in  
automatic equipment -  
reduce assembly time



**Polymer - pivoting**

- One-piece mounting bracket
- Corrosion-resistant
- Available preassembled
- Inner and outer attachment possible
- Available with or without integrated strain relief tiwrap plates

Moving end with bore (outer link) 080...1(PZ)

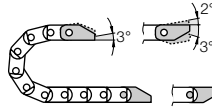

080...2(PZ) Fixed end with pin (inner link)

Possible installation conditions for assembled mounting brackets ▶ Order example "preassembled" below

080...1(PZ)

Moving end

080...2(PZ)

Fixed end

**Dimensions and order configurations**

Strain relief is possible on the moving end and/or the fixed end.

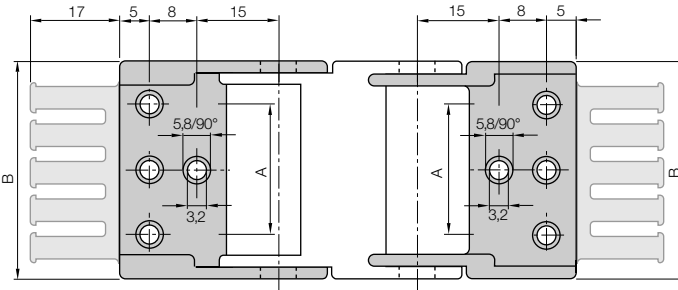

080.06.12 - 080.20.12: center bores only

080.30.12 - 080.50.12: bores (see figure above)

For E-chain*	Part No. full set with tiwrap plate	Part No. full set without tiwrap plate	Number of teeth	Dim. A [mm]	Dim. B [mm]
09.10. ▶	080.10. 12 PZ	080.10. 12	1	-	18,2
09.16. ▶	080.16. 12 PZ	080.16. 12	2	-	24,2
09.20. ▶	080.20. 12 PZ	080.20. 12	2	-	28,2
09.30. ▶	080.30. 12 PZ	080.30. 12	3	22	38,2
09.40. ▶	080.40. 12 PZ	080.40. 12	4	32	48,2
09.50. ▶	080.50. 12 PZ	080.50. 12	5	42	58,2

For the preassembled mode please add the index [A1] ... [A4] Example: 080.16. 12 PZ [A1]

**Part No. structure**

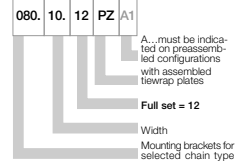

Full set, for both ends:

080. 10. 12 PZ +tiwrap plate

Single-part order:

080. 10. 1 PZ +tiwrap plate

Mounting bracket with bore

080. 10. 2 PZ +tiwrap plate

Mounting bracket with pin



**Quicksnap** - the complete, detachable mounting unit, available upon request



**Quickfix** - mounting bracket with dowel, available upon request

**Additional Features**

Phone +49- (0) 22 03-96 49-800  
Fax +49- (0) 22 03-96 49-222



## Zipper | E-Chains® | Series 15

● ● ● Price index



Cleanroom Class 1 (ISO class 3)  
tested by the Dryden Engineering  
Company, California



UL94-V2 classifications  
upon request



Low-noise



"Zipper-fast" opening and closing



### When to use the Series 15:

- If fast, zipper-like accessibility to cables is required
- If connection options are required (Quicksnap, Quickfix, ...)
- If interior separation is required
- If high stability and long service life are required



### When not to use it:

- If opening of the link is not necessary
  - ▶ Series 10 E2 mini, page 5.40
- If torsion occurs
  - ▶ Series E14 Easy Chain®, page 3.32
- If the chain must snap-open along the inner radius
  - ▶ B15i E2 mini, page 5.62
- If a closed tube system is required
  - ▶ Series R15, page 4.36

- ① "Zipper-fast" opening and closing
- ② For high acceleration
- ③ Large pins and double stop dog for superior life and long unsupported length
- ④ Zipper lids can be separated and joined at each chain link
- ⑤ Small pitch for low-noise, smooth operation
- ⑥ Mounting bracket with integrated strain relief
- ⑦ Interior separation with Vertical Separators and Full-Width Shelves possible
- ⑧ Also available as "Zipper" E-Tube Series R15 ▶ page 4.36

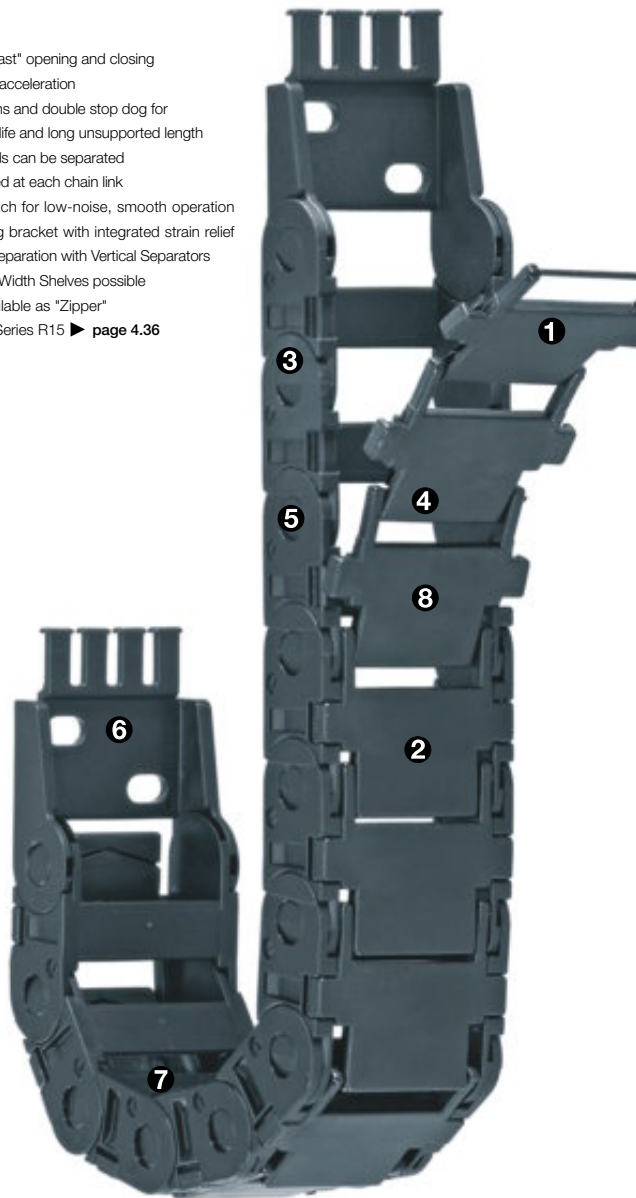

### Order example complete E-Chain®

Please indicate chain-lengths or number of links **Example: 1 m or 33 links**

1 m 15.025.038.0

E-Chain®

with 2 separators 154 assembled every 2<sup>nd</sup> link

Interior separation

1 set 1025.12PZ

Mounting bracket

**Unsupported length**

$FL_G$  = with straight upper run

$FL_B$  = with permitted sag

Further information ► Design, page 1.12

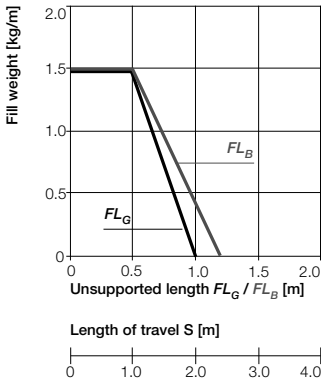
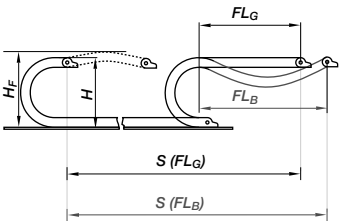

- $S$  = Length of travel
- $R$  = Bending radius
- $H$  = Nominal clearance height
- $H_F$  = Required clearance height
- $D$  = Overlength E-Chain® radius in final position
- $K = \pi \cdot R + \text{"safety"}$

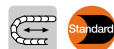
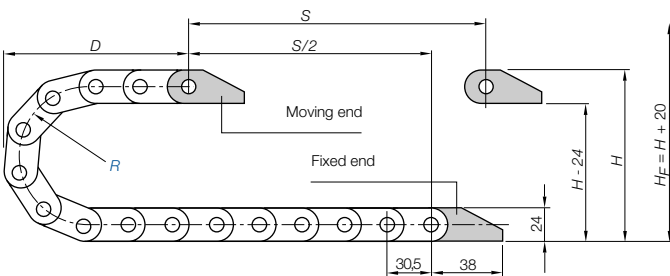

**Short travels - unsupported**

Unsupported E-Chains® feature positive camber over short travels. This must be accounted for when specifying the clearance height  $H_F$ . Please consult igus® if space is particularly restricted.

Pitch = 30,5 mm/link Links/m = 33 (1.006,5 mm) Chain length =  $S/2 + K$

$R$	038	048	075	100	110	125	145	180
$H$	100	120	175	225	245	275	315	385
$D$	90	120	145	155	170	190	225	279
$K$	185	215	300	375	410	455	520	630

The required clearance height:  
 $H_F = H + 20$  mm  
 (with 1,0 kg/m fill weight)

**Chip protection**

- Fully enclosed E-Tube with zipper opening mechanism
  - Protection against dirt and chips
  - Superfast opening of interconnected lids
  - Modular design - tool-free lengthening and shortening
  - Small pitch for low noise, smooth operation, high acceleration
- Zipper E-Tube R15, inner height 17 mm ► from page 4.36**



Speed / acceleration $FL_G$	max. 20 [m/s] / max. 200 [m/s <sup>2</sup> ]
Speed / acceleration $FL_B$	max. 3 [m/s] / max. 6 [m/s <sup>2</sup> ]
Gliding speed / acceleration (maximum)	max. 10 [m/s] / max. 50 [m/s <sup>2</sup> ]
Material - permitted temperature °C	igumid G / -40° to +130° C
Flammability class, igumid G	VDE 0304 IIC UL94 HB

**Technical Data**



Details of material properties  
 ► page 1.38



Zipper E-Chains®  
 Inner height: 17 mm

Phone +49- (0) 22 03-96 49-800  
 Fax +49- (0) 22 03-96 49-222



► page 4.5



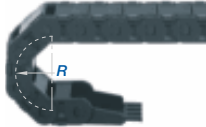
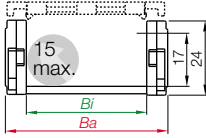

Series 15 E-Chain® - zip-open along outer radius

Part No.	Bi [mm]	Ba [mm]	R [mm]	Bending Radii								Weight [kg/m]
15.015.□.0	15	26	038	048	075	100	110	125	145	180	~ 0,35	
15.025.□.0	25	36	038	048	075	100	110	125	145	180	~ 0,40	
15.038.□.0	38	49	038	048	075	100	110	125	145	180	~ 0,46	
15.050.□.0	50	61	038	048	075	100	110	125	145	180	~ 0,52	
15.5.□.0	63	76	038	048	075	100	110	125	145	180	~ 0,63	
15.6.□.0	80	94	038	048	075	100	110	125	145	180	~ 0,70	
15.7.□.0	100	113	038	048	075	100	110	125	145	180	~ 0,76	

Supplement part no. with required radius (R) Example: 15.025.038.0

0 = standard color, other colors ▶ page 1.39 · Pitch = 30,5 mm/link - Links/m = 33

Part No. structure

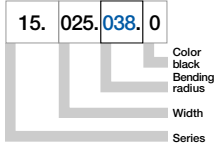

Zipper | Series 15 | Accessories | Interior Separation

Vert. Separator, slotted	153
unassembled	153
assembled	154



Option 1: Vertical Separators

- Vertical Separators are used if a vertical subdivision of the E-Chain® interior is required
- Standard subdivision with Vertical Separator, slotted 154, for combinations with Full-Width Shelf 111.X
- By standard Vertical Separators are assembled every other chain link.

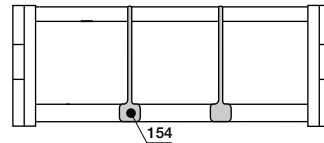

Side Plate	155
unassembled	155
assembled	156



Option 2: Full-Width Shelves

- For applications involving many thin cables with similar or identical diameters.
- Side Plate 156 can be combined with Vertical Separator, slotted 154 and Full-Width Shelf 111.X

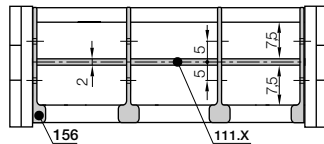

Full-Width Shelf	X
	X
	t = 2

Width X [mm]	Part No. unassembled	Part No. assembled
015	110.15	111.15
025	110.25	111.25
038	110.38	111.38
050	110.50	111.50

Width X [mm]	Part No. unassembled	Part No. assembled
063	110.63	111.63
080	110.80	111.80
100	110.100	111.100

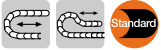

### The Standard - option polymer - pivoting

- Recommended for unsupported and gliding applications
- Well suited for tight installation conditions
- Strain relief with detachable tiwrap plates
- Variable traverse angle for flexible assembly
- The twistability of the E-Chain® and the option to assemble the mounting brackets on the fixed end and/or the moving end, enable various installation options

Moving end with bore (outer link) 10...3P(Z)

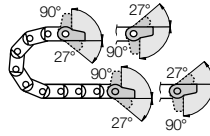

10...4P(Z) Fixed end with pin (inner link)

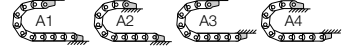
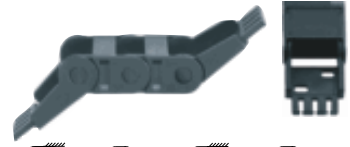

Possible installation conditions for assembled mounting brackets ▶ Order example "preassembled" below

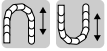

### Option polymer - locking

- Recommended for unsupported and gliding applications
- At very high speed and/or acceleration
- If space is limited for height (the  $H_f$  measurement)
- The twistability of the E-Chain® and the option to assemble the mounting brackets on the fixed end and/or the moving end, enable various installation options

Moving end with bore (outer link) 10...1P(Z)

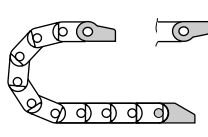

10...2P(Z) Fixed end with pin (inner link)

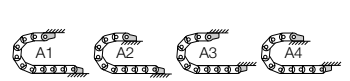

Possible installation conditions for assembled mounting brackets ▶ Order example "preassembled" below

10...3P(Z) Standard! (pivoting)  
10...1P(Z) (locking)

Moving end

For E-chain®: 15.015 to 15.050.

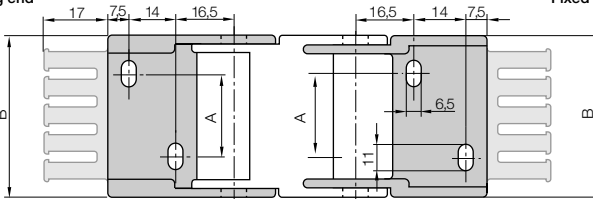

For E-chain®: 15.5 to 15.7.

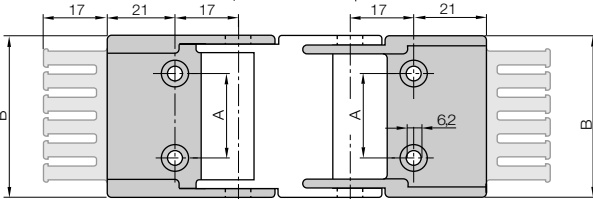

For E-chain®	Part No. full set with tiwrap plate	Part No. full set without tiwrap plate	Number of teeth	Dim. A [mm]	Dim. B [mm]
15.015. ▶	1015. [ ] PZ	1015. [ ] P	2	-	25,5
15.025. ▶	1025. [ ] PZ	1025. [ ] P	3	10	35,5
15.038. ▶	1038. [ ] PZ	1038. [ ] P	4	23	48,5
15.050. ▶	1050. [ ] PZ	1050. [ ] P	5	35	60,5
15.5. ▶	105. [ ] PZ	105. [ ] P	6	48	75,0
15.6. ▶	106. [ ] PZ	106. [ ] P	8	65	92,0
15.7. ▶	107. [ ] PZ	107. [ ] P	10	85	112,0

Please add the Part No. with the requested index - 34 for the pivoting configuration

e.g. 1015. [34] PZ or 12 for the locking configuration e.g. 1015. [12] PZ

For the preassembled mode please add the index [A1]...[A4] e.g. 1015. [34] PZ [A1]

Standard! (pivoting) 10...4P(Z) (locking) 10...2P(Z)  
Fixed end

### Dimensions and order configurations

Strain relief is possible on the moving end and/or the fixed end.

Part No. structure (pivoting)

1015. 34 PZ A1



A... must be indicated on preassembled configurations with assembled tiwrap plates  
Full set pivoting = 34  
Mounting brackets for selected chain type

Full set, for both ends:

1015. [34] PZ +tiwrap plate

Single-part order:

1015. [3] PZ +tiwrap plate

Mounting bracket with bore

1015. [4] PZ +tiwrap plate

Mounting bracket with pin

Part No. structure (locking)

1015. 12 PZ A1

A... must be indicated on preassembled configurations with assembled tiwrap plates  
Full set = 12  
Mounting brackets for selected chain type

Full set, for both ends:

1015. [12] PZ +tiwrap plate

Single-part order:

1015. [1] PZ +tiwrap plate

Mounting bracket with bore

1015. [2] PZ +tiwrap plate

Mounting bracket with pin

Quicksnap + Quickfix upon request



▶ page 4.5

- Ba** = Outer width E-Chains® / E-Tube
- Bi** = Inner width E-Chains® / E-Tube
- ha** = Outer height E-Chains® / E-Tube
- H<sub>Ri</sub>** = Inner trough height
- H<sub>Ra</sub>** = Outer trough height
- B<sub>Ri</sub>** = Inner trough width ► depends on dim. Ba
- B<sub>Ra</sub>** = Outer trough width
- n<sub>Mon</sub>** = Number of installation sets (left/right)
- n<sub>Ri</sub>** = Number of trough sets (left/right)
- $H_{Ri} \geq 2 \cdot ha$   
 $B_{Ri} \geq Ba + 4$

- = Guide trough set      ● = Glide bar
- = Installation set "Basic"      ● = C-profile

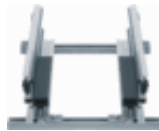
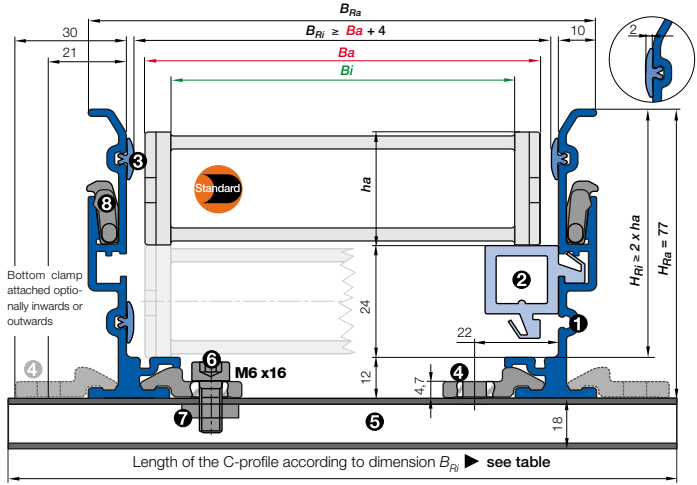

- **Components, trough "Basic":** ① Trough side parts, aluminum, 2 m ② Glide bar, plastic, 2 m ③ Glide strips, plastic, 2 m (without glide strips on request)
- **Components, installation set "Basic":** ④ Bottom clamp, aluminum ⑤ C-profile, steel galvanized ⑥ Screw M6 x16 ⑦ Sliding nut M6 ⑧ Interface connector, plastic

**Installation set "Basic" with C-profile**

Bottom Clamp attached optionally inwards or outwards

15.5.038.0 ► Order example

	Part No. attached inwards [mm]	Part No. attached outwards	Order example	
			B <sub>Ri</sub>	B <sub>Ri</sub>
.015	30	-	960.30.125	
.025	40	-	960.30.150	
.038	53	-	960.30.150	
.050	65	960.30.125	960.30.175	
.5	80	960.30.125	960.30.175	
.6	98	960.30.150	960.30.200	
.7	117	960.30.175	960.30.225	

**Order example: Length of travel 30 m - Center mounted for Series 15.5.050.0 with B<sub>Ri</sub> = 65**

- Guide trough set (set of 2 trough side parts, incl. glide strips) **without** glide bar  
**Order text: 16 m guide trough without glide bar (8 x 2 m sections) Part No. 970.30.SL**
- Guide trough set (set of 2 trough side parts, incl. glide strips) **with** glide bar  
**Order text: 16 m guide trough with glide bar (8 x 2 m sections) Part No. 970.31.SL**
- Installation set "Basic" complete (guide trough-sets + 1)  
**Order text: 17 installation sets "Basic" Part No. 960.30.125**

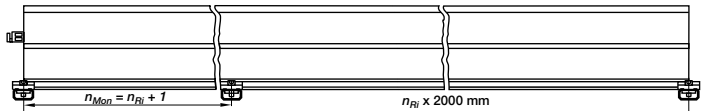

Principle sketch: Number of installation sets to be installed = **Number of trough sections + 1**

**Other guide trough systems**



"Single-piece steel guide troughs" with trough glide surface ► chapter 9



"Snap in trough" easy and fast assembly, favorable price due to simple structure, narrow design ► chapter 9

Phone +49- (0) 22 03-96 49-800  
 Fax +49- (0) 22 03-96 49-222

igus® GmbH  
 51147 Cologne

Internet: www.igus.de  
 E-mail: info@igus.de

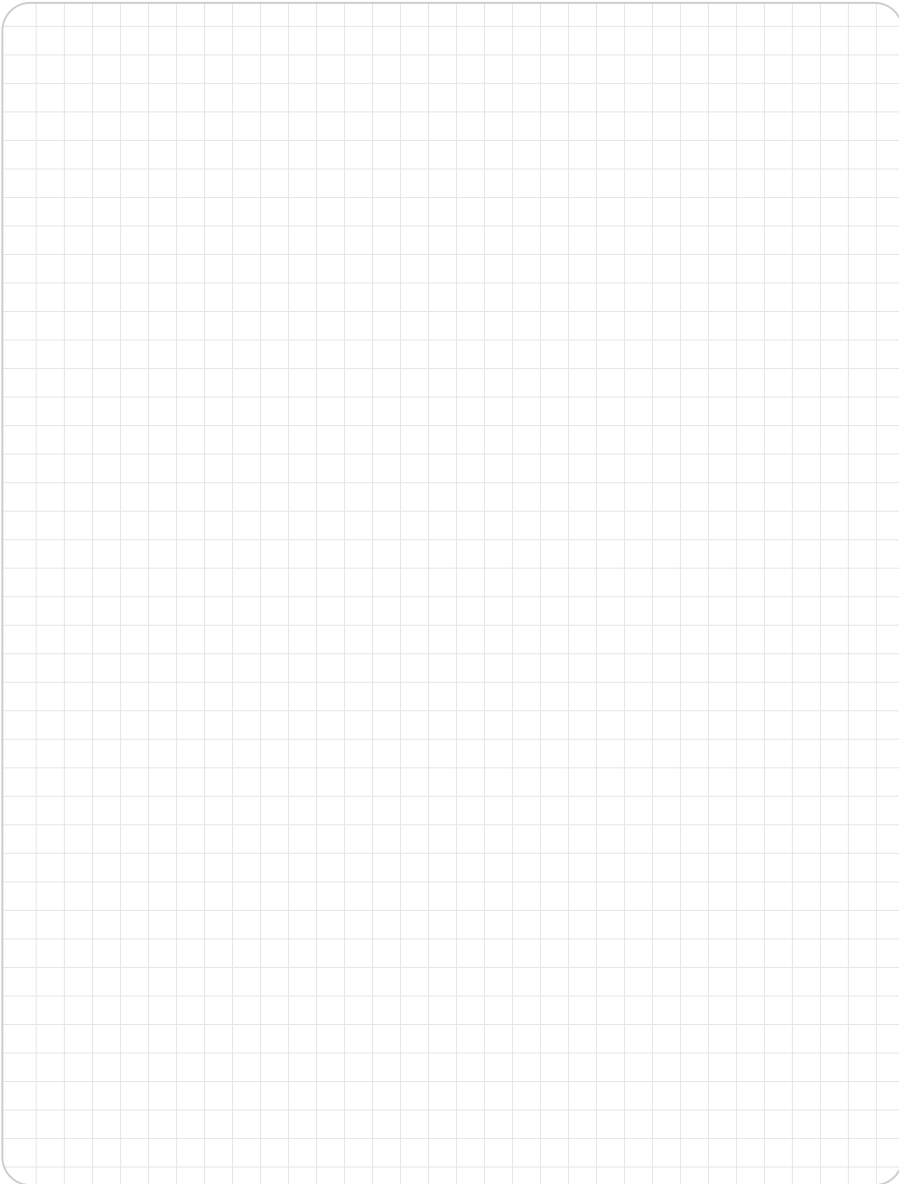

Zipper E-Chains®  
Inner height: 17 mm

Phone +49- (0) 22 03-96 49-800  
Fax +49- (0) 22 03-96 49-222



▶ chapter 9



▶ page 4.5

## TPE outer jacket - Chainflex® CF9

TIP!

oil- and bio-oil-resistant, PVC- and halogen-free, low-temperature-flexible  
Further information: [www.igus.de/en/CF9](http://www.igus.de/en/CF9)

IGUS® CHAINFLEX® CF9

## Zipper | E-Chains® | Series 17

● ● ● Price index

**Clean-Room**

Upon request: Cleanroom Class 1 (ISO class 3) tested by the Dryden Engineering Company, California

**UL**

UL94-V2 classifications upon request



Low-noise

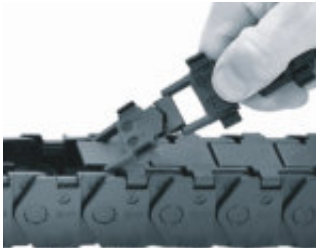

"Zipper-fast" opening and closing



### When to use the Series 17:

- If fast, zipper-like accessibility to cables is required
- If connection options are required (Quicksnap, Quickfix, ...)
- If quiet operation is required
- If aesthetic design is required



### When not to use it:

- If individual links must snap-open, as opposed to "unzip"
  - ▶ Series B17 E2 mini, page 5.68
- If torsion occurs
  - ▶ Series E16 Easy Chain®, page 3.42
- If a closed tube system is required
  - ▶ Series R17, page 4.42

- ① "Zipper-fast" opening and closing
- ② Small pitch for low-noise, smooth operation
- ③ For high acceleration
- ④ Zipper lids can be separated and joined at each chain link
- ⑤ Interior separation with Vertical Separators and Full-Width Shelves possible
- ⑥ Mounting bracket with integrated strain relief
- ⑦ Also available as "Zipper" E-Tube Series R17 ▶ page 4.42



### Order example complete E-Chain®

Please indicate chain-lengths or number of links **Example: 1 m or 33 links**

1 m 17.2.063.0

E-Chain®

with 2 separators 172 assembled every 2<sup>nd</sup> link

Interior separation

1 set 117.2.12PZ

Mounting bracket

**Unsupported length**

$FL_G$  = with straight upper run

$FL_B$  = with permitted sag

Further information **Design, page 1.12**

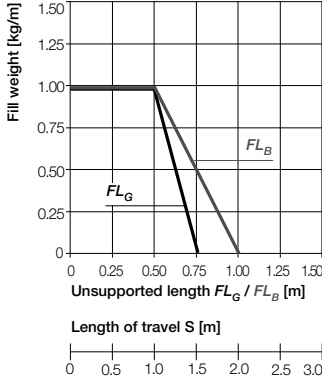
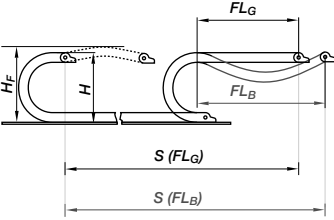

- $S$  = Length of travel
- $R$  = Bending radius
- $H$  = Nominal clearance height
- $H_F$  = Required clearance height
- $D$  = Overlength E-Chain®

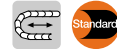
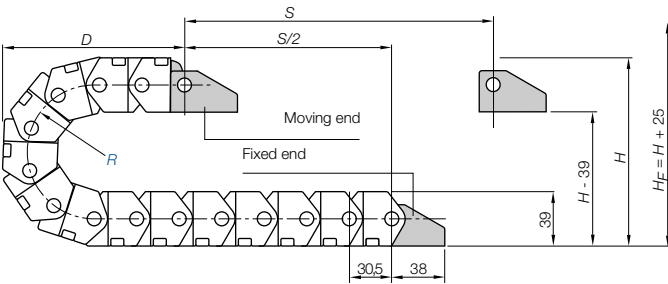

**Short travels - unsupported**

Unsupported E-Chains® feature positive camber over short travels. This must be accounted for when specifying the clearance height  $H$ . Please consult igus® if space is particularly restricted.

**Pitch = 30,5 mm/link Links/m = 33 (1.006,5 mm) Chain length =  $\frac{S}{2} + K$**

	063	075	100	125
$R$	165	189	239	289
$H$	115	130	155	180
$D$	275	305	395	475

The required clearance height:  
 $H_F = H + 25$  mm  
 (with 1,5 kg/m fill weight)

**Chip protection**

- Fully enclosed E-Tube with zipper opening mechanism
- Protection against dirt and chips
- Superfast opening of interconnected lids
- Modular design - tool-free lengthening and shortening
- Small pitch for low noise, smooth operation, high acceleration

**Zipper E-Tube R17, inner height 32 mm ▶ from page 4.42**



Speed / acceleration $FL$	max. 20 [m/s] / max. 200 [m/s]
Speed / acceleration $FL_B$	max. 3 [m/s] / max. 6 [m/s]
Gliding speed / acceleration (maximum)	max. 10 [m/s] / max. 50 [m/s]
Material - permitted temperature °C	igumid G / -40° to +130° C
Flammability class, igumid G	VDE 0304 IIC UL94 HB

**Technical Data**



**Details of material properties**  
 ▶ page 1.38



**Zipper E-Chains®**  
 Inner height: 32 mm

Phone +49- (0) 22 03-96 49-800  
 Fax +49- (0) 22 03-96 49-222



▶ page 4.5



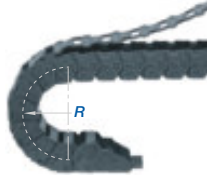
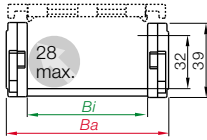

Series 17 E-Chain® - zip-open along outer radius

Part No.	Bi [mm]		Ba [mm]		R [mm]			Bending Radii	Weight [kg/m]
	0	1	0	1	063	075	100		
17.1.	15	26	063	075	100	125		~ 0,52	
17.2.	25	36	063	075	100	125		~ 0,59	
17.3.	38	49	063	075	100	125		~ 0,65	
17.4.	50	61	063	075	100	125		~ 0,70	
17.5.	63	76	063	075	100	125		~ 0,83	
17.6.	80	94	063	075	100	125		~ 0,92	
17.7.	100	113	063	075	100	125		~ 1,06	

Supplement part no. with required radius (R) Example: 17.2.063.0

0 = standard color, other colors ▶ page 1.39 · Pitch = 30,5 mm/link - Links/m = 33

Part No. structure

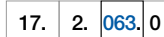

Zipper | Series 17 | Accessories | Interior Separation

Vert. Separator, slotted

for 17.1 to 17.4

unassembled	171
assembled	172



Vert. Separator, slotted

for 17.5 to 17.7

unassembled	173
assembled	174



Option 1: Vertical Separators

- Vertical Separators are used if a vertical subdivision of the E-Chain® interior is required
- Standard horizontal subdivision on Series 17.1 to 17.4: with Vertical Separator, slotted 172, for Series 17.5 to 17.7: Vertical Separator, slotted 174, both for combinations with Full-Width Shelf 111.X
- By standard Vertical Separators are assembled every other chain link.

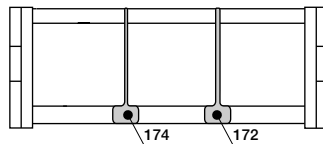

Side Plate

for 17.1 to 17.4

unassembled	175
assembled	176



Side Plate

for 17.5 to 17.7

unassembled	177
assembled	178



Option 2: Full-Width Shelves

- For applications involving many thin cables with similar or identical diameters
- Side Plate 176 (Series 17.1 to 17.4) and 178 (Series 17.5 to 17.8) can be combined with Vertical Separator, slotted 172 or 174 and Full-Width Shelf 111.X

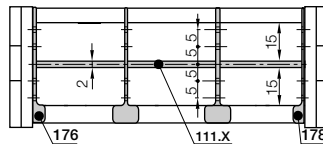

Full-Width Shelf

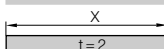

Width X [mm]	Part No. unassembled	Part No. assembled
015	110.15	111.15
025	110.25	111.25
038	110.38	111.38
050	110.50	111.50

Width X [mm]	Part No. unassembled	Part No. assembled
063	110.63	111.63
080	110.80	111.80
100	110.100	111.100



**Polymer, one-piece**

- One-piece mounting bracket
- Corrosion-resistant
- Available preassembled
- Inner and outer attachment possible
- Available with or without integrated strain relief tiwrap plates

Moving end with bore (outer link) 117...1P(Z)

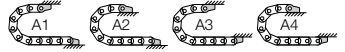
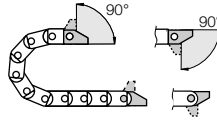

117...2P(Z) Fixed end with pin (inner link)

Possible installation conditions for assembled mounting brackets ▶ Order example "preassembled" below

117...1P(Z)

Moving end

117...2P(Z)

Fixed end

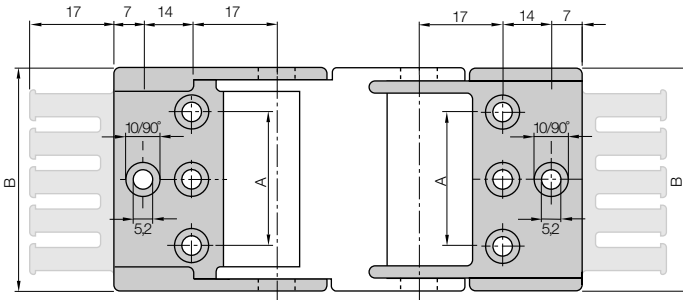

117.1.12P(Z): center bores only

117.2.12P(Z) - 117.7.12P(Z): outer bores only

For E-chain®	Part No. full set with tiwrap plate	Part No. full set without tiwrap plate	Number of teeth	Dim. A [mm]	Dim. B [mm]
17.1. ▶	117.1. 12 PZ	117.1. 12 P	2	-	25,5
17.2. ▶	117.2. 12 PZ	117.2. 12 P	3	12	35,5
17.3. ▶	117.3. 12 PZ	117.3. 12 P	4	25	48,5
17.4. ▶	117.4. 12 PZ	117.4. 12 P	5	37	60,5
17.5. ▶	117.5. 12 PZ	117.5. 12 P	6	48	76,0
17.6. ▶	117.6. 12 PZ	117.6. 12 P	8	65	93,0
17.7. ▶	117.7. 12 PZ	117.7. 12 P	10	85	113,0

For the preassembled mode please add the index [A1]...[A4] Example: 117.1. 12 PZ[A1]

**Dimensions and order configurations**

Strain relief is possible on the moving end and/or the fixed end.

**Part No. structure**

117. 1. 12 PZ A1

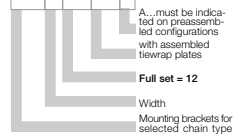

Full set, for both ends:

117.1. 12 PZ +tiwrap plate

Single-part order:

117.1. 1 PZ +tiwrap plate

Mounting bracket with bore

117.1. 2 PZ +tiwrap plate

Mounting bracket with pin



**Quicksnap** - the complete, detachable mounting unit, available upon request



**Quickfix** - mounting bracket with dowel, available upon request

**Additional Features**

Phone +49- (0) 22 03-96 49-800  
Fax +49- (0) 22 03-96 49-222



## Zipper | E-Tubes | Series R07

● ● ● Price index

**Clean-Room**

Upon request: Cleanroom Class 1 (ISO class 3) tested by the Dryden Engineering Company, California

**UL**

UL94-V2 classifications upon request



Low-noise



"Zipper-fast" opening and closing



### When to use the Series R07:

- If extremely quick, zipper-like access to cables is required
- If chip protection is required
- If quick, easy insertion of cables with preassembled connectors is required
- If aesthetic design is required



### When not to use it:

- If opening of the link is not necessary
  - ▶ Series 06 E2 micro, page 5.26
- If cable installation without opening lids is possible
  - ▶ Series E06 Easy Chain\*, page 3.20

- ① "Zipper-fast" opening and closing
- ② Small pitch for low-noise, smooth operation
- ③ For high acceleration
- ④ Light weight
- ⑤ Zipper lids can be separated and joined at each chain link
- ⑥ Protection against dirt and chips
- ⑦ Mounting bracket with integrated strain relief
- ⑧ Smallest zip-open E-Tube
- ⑨ Also available as "Zipper" E-Chain® Series 07 ▶ page 4.10

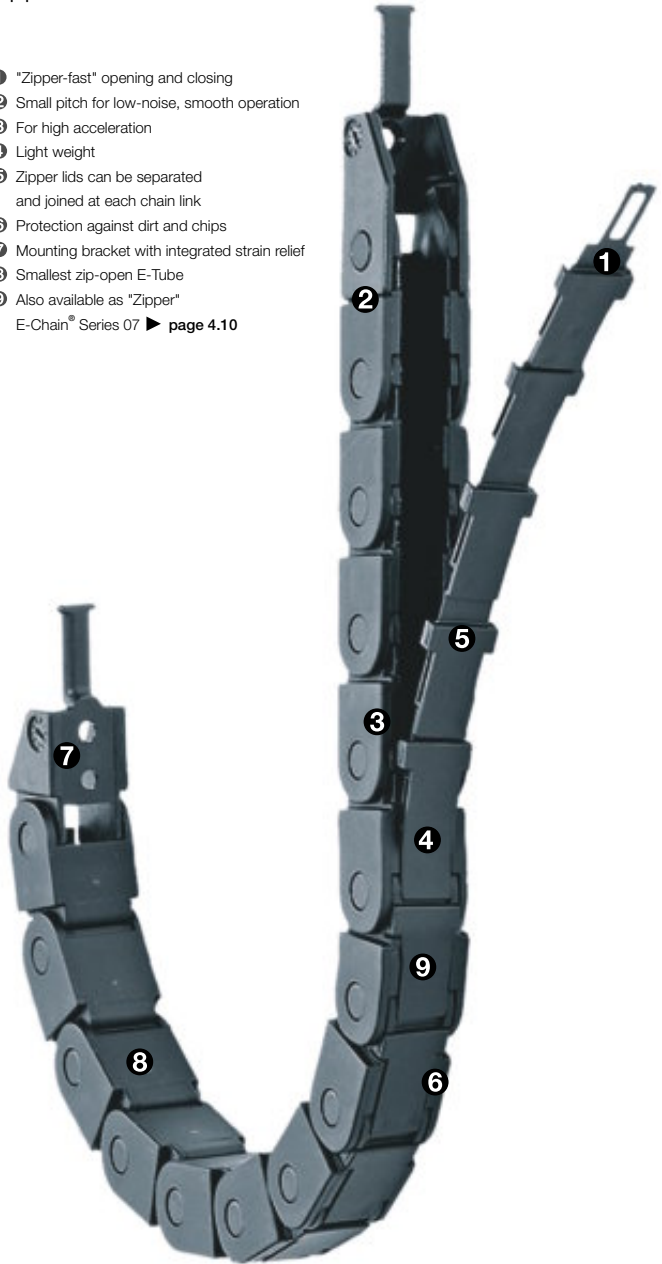

### Order example complete E-Tube

Please indicate tube-lengths or number of links Example: 1 m or 50 links

1 m R07.20.038.0



E-Tube

1 set 060.20.12PZ



Mounting bracket

**Unsupported length**

$FL_G$  = with straight upper run

$FL_B$  = with permitted sag

Further information ► **Design, page 1.12**

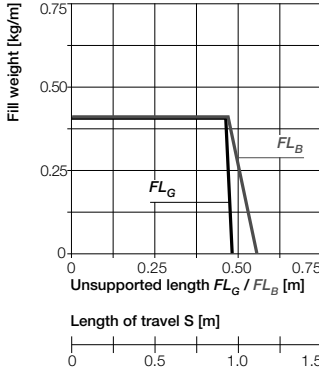
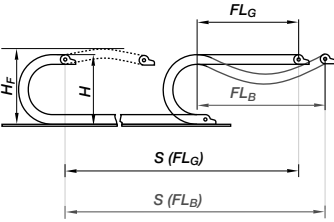

- $S$  = Length of travel
- $R$  = Bending radius
- $H$  = Nominal clearance height
- $H_F$  = Required clearance height
- $D$  = Overlength E-Chain® radius in final position
- $K = \pi \cdot R + \text{"safety"}$

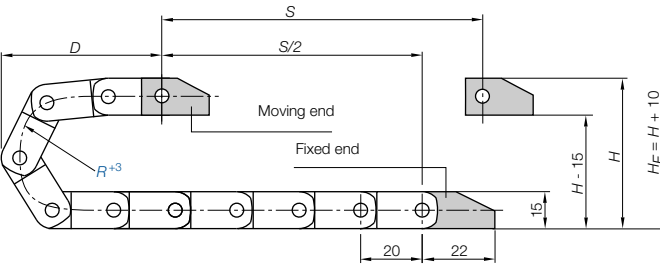

**Pitch = 20 mm/link   Links/m = 50 (1.000 mm)   Chain length =  $S/2 + K$**

$R$	038	048
$H$	92	112
$D$	65	75
$K$	160	190

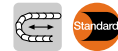

**Short travels - unsupported**

Unsupported E-Chains® feature positive camber over short travels. This must be accounted for when specifying the clearance height  $H_F$ . Please consult igus® if space is particularly restricted.

The required clearance height:  
 $H_F = H + 10 \text{ mm}$   
 (with 0,2 kg/m fill weight)



**Zipper EE-Tubes**  
**Inner height: 10,3 mm**

**Phone +49- (0) 22 03-96 49-800**  
**Fax +49- (0) 22 03-96 49-222**



**Chainflex® CF98 - tested 30 million strokes with 4xd**

TPE outer jacket, oil- and bio-oil-resistant, PVC and halogen-free, low-temperature-flexible  
 Further information: [www.igus.de/en/CF98](http://www.igus.de/en/CF98)



Speed / acceleration $FL_G$	max. 20 [m/s] / max. 200 [m/s]
Speed / acceleration $FL_B$	max. 3 [m/s] / max. 6 [m/s]
Gliding speed / acceleration (maximum)	max. 10 [m/s] / max. 50 [m/s]
Material - permitted temperature °C	igumid G / -40° to +130° C
Flammability class, igumid G	VDE 0304 IIC UL94 HB

**Technical Data**



**Details of material properties**  
 ► page 1.38



► page 4.5

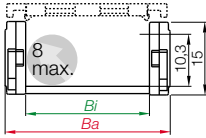

Part No. structure

R07.	20.	038.	0
------	-----	------	---



Color  
black  
Bending  
radius  
Width  
Series

## Series R07 E-Tube - zip-open along the outer radius

Part No.	<i>Bi</i> [mm]	<i>Ba</i> [mm]	<i>R</i> [mm]	Bending Radii	Weight [kg/m]
R07.10.□.0	10	16,5	038	048	~ 0,14
R07.16.□.0	16	22,5	038	048	~ 0,16
R07.20.□.0	20	27,0	038	048	~ 0,17
R07.30.□.0	30	37,0	038	048	~ 0,20
R07.40.□.0	40	47,0	038	048	~ 0,23
R07.50.□.0	50	57,0	038	048	~ 0,26

Supplement part no. with required radius (*R*) Example: R07.20.038.0

0 = standard color, other colors ► page 1.39 · Pitch = 20 mm/link - Links/m = 50





**Polymer, one-piece**

- One-piece mounting bracket
- Corrosion-resistant
- Available preassembled
- Inner and outer attachment possible
- Available with or without integrated strain relief tiwrap plates

Moving end with bore (outer link) 060...1(PZ)

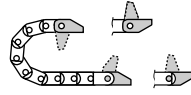

060...2(PZ) Fixed end with pin (inner link)

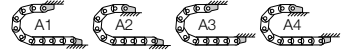

Possible installation conditions for assembled mounting brackets ▶ Order example "preassembled" below

060...1(PZ)

Moving end

060...2(PZ)

Fixed end

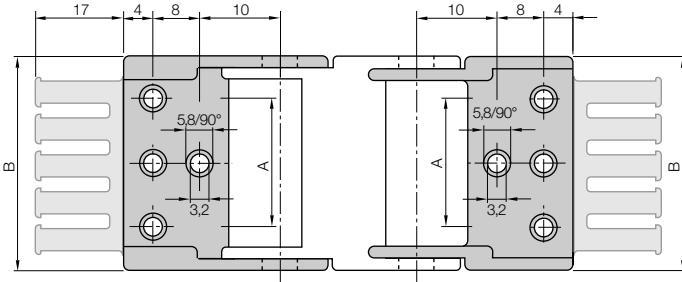

060.10.12 - 060.20.12: center bores only

060.30.12 - 060.50.12: outer bores only

For E-chain*	Part No. full set with tiwrap plate	Part No. full set without tiwrap plate	Number of teeth	Dim. A [mm]	Dim. B [mm]
R07.10. ▶	060.10. 12 PZ	060.10. 12	1	-	16,5
R07.16. ▶	060.16. 12 PZ	060.16. 12	2	-	22,5
R07.20. ▶	060.20. 12 PZ	060.20. 12	2	-	27,0
R07.30. ▶	060.30. 12 PZ	060.30. 12	3	22	37,0
R07.40. ▶	060.40. 12 PZ	060.40. 12	4	32	47,0
R07.50. ▶	060.50. 12 PZ	060.50. 12	5	42	57,0

For the preassembled mode please add the index **A1...A4** Example: 060.10. 12 | A1

**Dimensions and order configurations**

Strain relief is possible on the moving end and/or the fixed end.

**Part No. structure**

060. 10. 12 PZ A1

A... must be indicated on preassembled configurations with assembled tiwrap plates

Full set = 12

Width

Mounting brackets for selected chain type

**Full set, for both ends:**

060. 10. 12 PZ + tiwrap plate

**Single-part order:**

060. 10. 1 PZ + tiwrap plate

Mounting bracket with bore

060. 10. 2 PZ + tiwrap plate

Mounting bracket with pin



**Quicksnap** - the complete, detachable mounting unit, available upon request



**Quickfix** - mounting bracket with dowel, available upon request

**Additional Features**

Phone +49- (0) 22 03-96 49-800  
Fax +49- (0) 22 03-96 49-222





Price index

Upon request: Cleanroom Class 1  
(ISO class 3) tested by the Dryden  
Engineering Company, California

UL94-V2 classifications  
upon request

iF-Design  
Award Winner

Low-noise

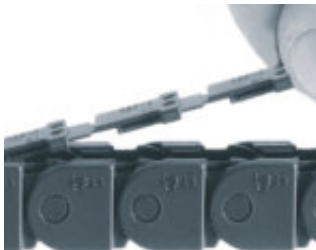

"Zipper-fast" opening and closing



#### When to use the Series R09:

- If extremely quick, zipper-like access to cables is required
- If chip protection is required
- If quick, easy insertion of cables with preassembled connectors is required
- If aesthetic design is required



#### When not to use it:

- If opening of the link is not necessary
  - ▶ Series 08 E2 micro, page 5.30
- If cable installation without opening lids is possible
  - ▶ Series E08 Easy Chain®, page 3.28

- ① "Zipper-fast" opening and closing
- ② Small pitch for low-noise, smooth operation
- ③ Protection against dirt and chips
- ④ iF-Design Award Winner
- ⑤ Light weight
- ⑥ Zipper lids can be separated and joined at each chain link
- ⑦ For high acceleration
- ⑧ Mounting bracket with integrated strain relief
- ⑨ Small zip-open E-Tube
- ⑩ Also available as "Zipper" E-Chain® Series 09 ▶ page 4.14

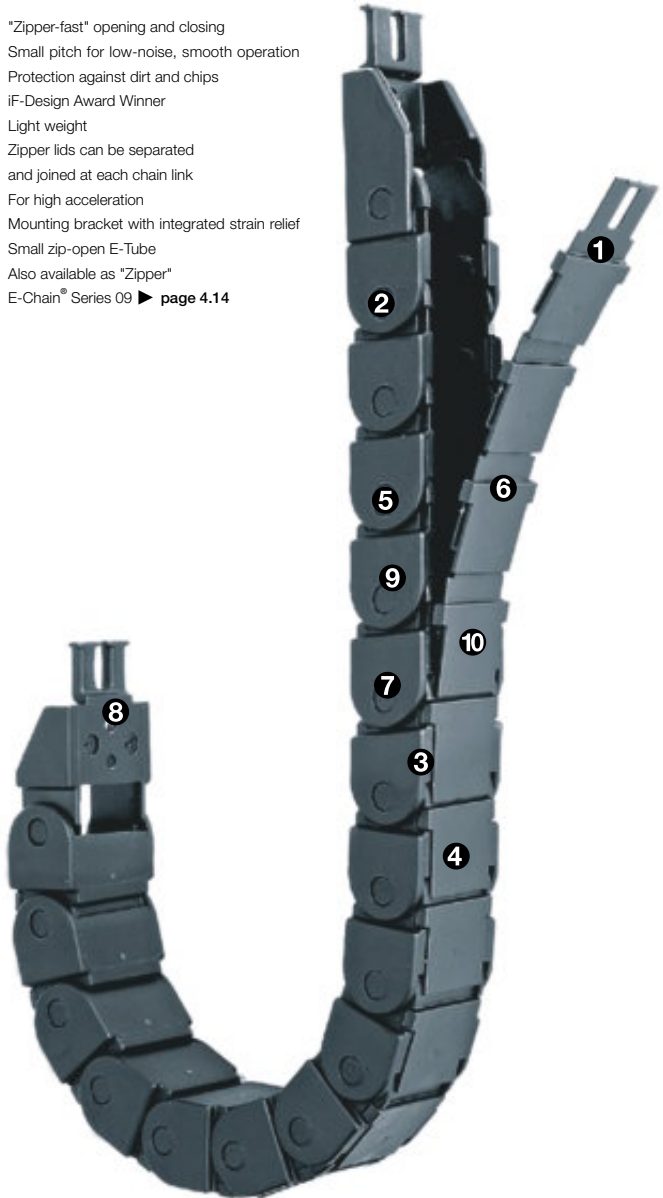

#### Order example complete E-Tube

Please indicate tube-lengths or number of links Example: 1 m or 50 links

1 m R09.20.048.0



E-Tube

1 set 080.20.12PZ



Mounting bracket

**Unsupported length**

$FL_G$  = with straight upper run

$FL_B$  = with permitted sag

Further information ► **Design, page 1.12**

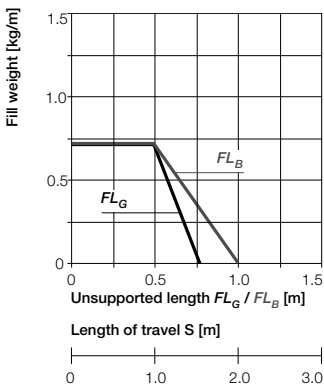
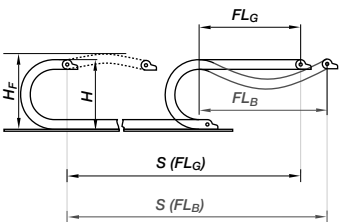

- $S$  = Length of travel
- $R$  = Bending radius
- $H$  = Nominal clearance height
- $H_F$  = Required clearance height
- $D$  = Overlength E-Chain® radius in final position
- $K = \pi \cdot R + \text{"safety"}$

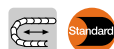
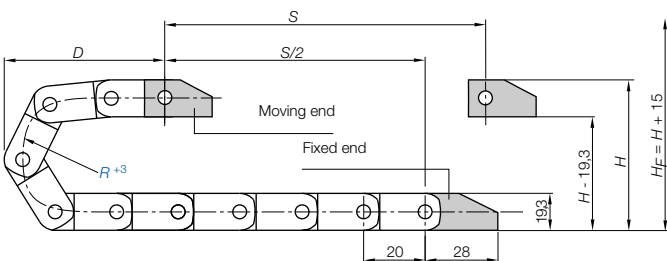

**Short travels - unsupported**

Unsupported E-Chains® feature positive camber over short travels. This must be accounted for when specifying the clearance height  $H_F$ . Please consult igus® if space is particularly restricted.

**Pitch = 20 mm/link    Links/m = 50 (1.000 mm)    Chain length =  $S/2 + K$**

$R$	048	075	100
$H$	116	170	220
$D$	80	107	132
$K$	190	280	360

The required clearance height:  
 $H_F = H + 15$  mm  
 (with 0,3 kg/m fill weight)



Zipper E-Tubes  
Inner height: 15 mm

Phone +49- (0) 22 03-96 49-800  
Fax +49- (0) 22 03-96 49-222



**High oil-resistants and UL, for example Chainflex® CF8 PUR-control cable**

**TIP!**

PUR-outer jacket, shielded, oil-resistant and coolant-resistant, flame retardant  
 Further information: [www.igus.de/en/CF8](http://www.igus.de/en/CF8)



Speed / acceleration $FL_G$	max. 20 [m/s] / max. 200 [m/s]
Speed / acceleration $FL_B$	max. 3 [m/s] / max. 6 [m/s]
Gliding speed / acceleration (maximum)	max. 10 [m/s] / max. 50 [m/s]
Material - permitted temperature °C	igumid G / -40° to +130° C
Flammability class, igumid G	VDE 0304 IIC UL94 HB

**Technical Data**



Details of material properties  
 ► page 1.38



► page 1.45

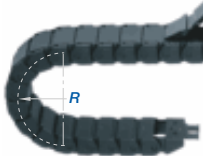
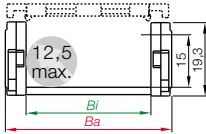

## Series R09 E-Tube - zip-open along the outer radius

Part No.	Bi [mm]	Ba [mm]	R [mm]	Bending Radii			Weight [kg/m]
R09.10.□.□.0	10	18,2	048	075	100	≈ 0,21	
R09.16.□.□.0	16	24,2	048	075	100	≈ 0,24	
R09.20.□.□.0	20	28,2	048	075	100	≈ 0,25	
R09.30.□.□.0	30	38,2	048	075	100	≈ 0,28	
R09.40.□.□.0	40	48,2	048	075	100	≈ 0,31	
R09.50.□.□.0	50	58,2	048	075	100	≈ 0,34	

Supplement part no. with required radius (R) Example: R09.20.048.0

0 = standard color, other colors ► page 1.39 · Pitch = 20 mm/link - Links/m = 50

Part No. structure

R09. 20. 048. 0





**Polymer, one-piece**

- One-piece mounting bracket
- Corrosion-resistant
- Available preassembled
- Inner and outer attachment possible
- Available with or without integrated strain relief tiwrap plates

Moving end with bore  
(outer link) 080...1(PZ)

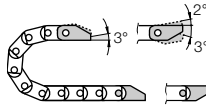

080...2(PZ) Fixed end  
with pin (inner link)

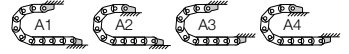

Possible installation conditions for assembled mounting brackets ▶ Order example "preassembled" below

080...1(PZ)

Moving end

080...2(PZ)

Fixed end

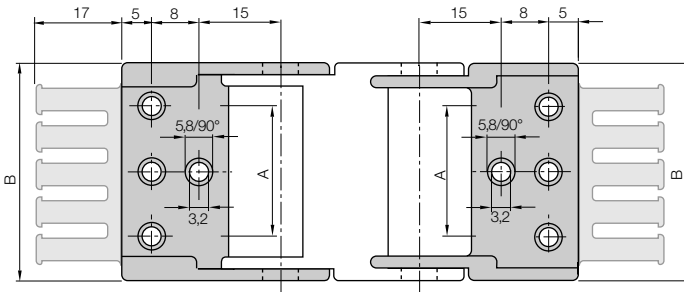

080.10.12 - 080.20.12: center bores only

080.30.12 - 080.50.12: bores (see figure above)

For E-chain*	Part No. full set with tiwrap plate	Part No. full set without tiwrap plate	Number of teeth	Dim. A [mm]	Dim. B [mm]
R09.10. ▶	080.10. 12 PZ	080.10. 12	1	-	18,2
R09.16. ▶	080.16. 12 PZ	080.16. 12	2	-	24,2
R09.20. ▶	080.20. 12 PZ	080.20. 12	2	-	28,2
R09.30. ▶	080.30. 12 PZ	080.30. 12	3	22	38,2
R09.40. ▶	080.40. 12 PZ	080.40. 12	4	32	48,2
R09.50. ▶	080.50. 12 PZ	080.50. 12	5	42	58,2

For the preassembled mode please add the index **A1...A4** Example: 080.16. 12 | A1

**Dimensions and order configurations**

Strain relief is possible on the moving end and/or the fixed end.

**Part No. structure**

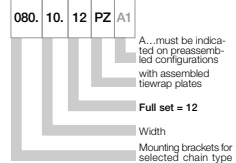

Full set, for both ends:

080 | 10 | 12 | PZ | +tiwrap plate

Single-part order:

080 | 10 | 1 | PZ | +tiwrap plate

Mounting bracket with bore

080 | 10 | 2 | PZ | +tiwrap plate

Mounting bracket with pin



**Quicksnap** - the complete, detachable mounting unit, available upon request



**Quickfix** - mounting bracket with dowel, available upon request

**Additional Features**

Phone +49- (0) 22 03-96 49-800  
Fax +49- (0) 22 03-96 49-222





Price index



Upon request: Cleanroom Class 3  
(ISO class 3) tested by the Dryden  
Engineering Company, California



UL94-V2 classifications  
upon request



Low-noise



"Zipper-fast" opening and closing

**When to use the Series R15:**

- If extremely quick, zipper-like access to cables is required
- If chip protection is required
- If quick, easy insertion of cables with preassembled connectors is required
- If aesthetic design is required

**When not to use it:**

- If opening of the link is not necessary
  - ▶ Series 10 E2 mini, page 5.40
- If torsion occurs
  - ▶ Series E14 Easy Chain", page 3.32
- If the chain must snap-open along the inner radius
  - ▶ B15i E2 mini, page 5.62

- ① "Zipper-fast" opening and closing
- ② Small pitch for low-noise, smooth operation
- ③ Protection against dirt and chips
- ④ Large pins and double stop dog for superior life and long unsupported length
- ⑤ Zipper lids can be separated and joined at each chain link
- ⑥ Mounting bracket with integrated strain relief
- ⑦ For high acceleration
- ⑧ Also available as "Zipper" E-Chain® Series 15 ▶ page 4.18

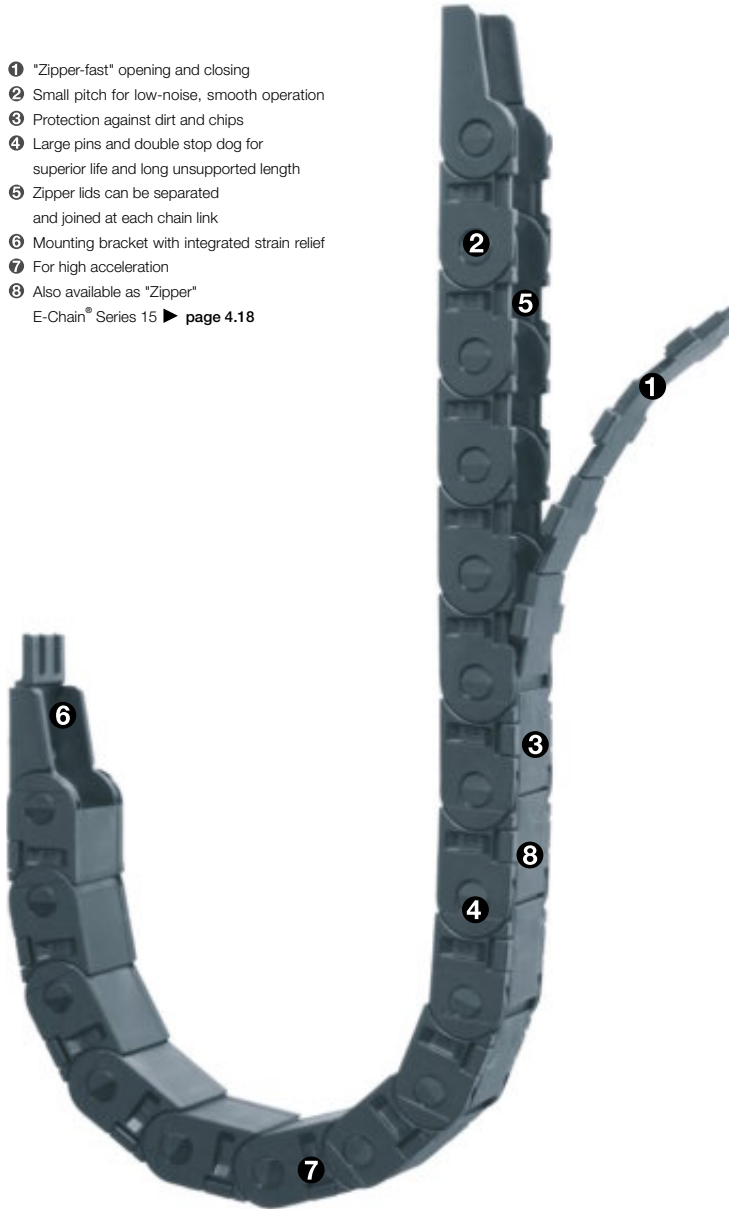
**Order example complete E-Tube**

Please indicate tube-lengths or number of links Example: 1 m or 33 links

1 m R15.025.063.0

E-Tube

with 2 separators R154 assembled every 2<sup>nd</sup> link

Interior separation

1 set 1025.12PZ

Mounting bracket

**Unsupported length**

$FL_G$  = with straight upper run

$FL_B$  = with permitted sag

Further information ► **Design**, page 1.12

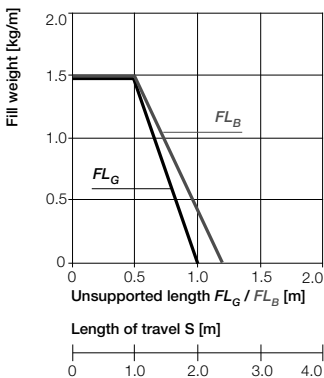
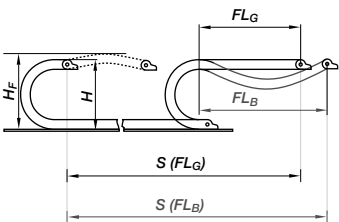

- $S$  = Length of travel
- $R$  = Bending radius
- $H$  = Nominal clearance height
- $H_F$  = Required clearance height
- $D$  = Overlength E-Chain® radius in final position
- $K = \pi \cdot R + \text{"safety"}$

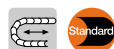
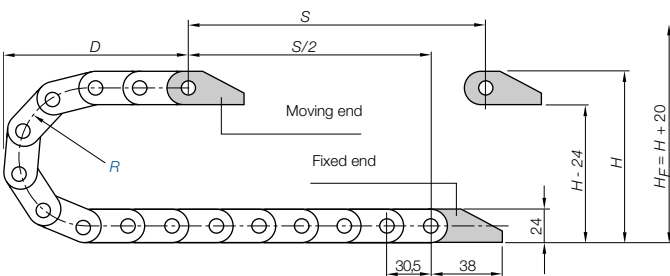

**Short travels - unsupported**

Unsupported E-Chains® feature positive camber over short travels. This must be accounted for when specifying the clearance height  $H_F$ . Please consult igus® if space is particularly restricted.

Pitch = 30,5 mm/link    Links/m = 33 (1.000 mm)    Chain length =  $S/2 + K$

$R$	063	075	100	110	125	145	180
$H$	150	175	225	245	275	315	385
$D$	120	145	155	170	190	225	279
$K$	260	300	375	410	455	520	630

The required clearance height:  
 $H_F = H + 20$  mm  
 (with 1,0 kg/m fill weight)

**Cheap, DESINA-compliant and oil-resistant Chainflex® CF170.D PUR-control cable**

**TIP!**

PUR-outer jacket, oil-resistant and coolant-resistant, PVC-free/halogen-free, low-temperature-flexible  
 Further information: [www.igus.de/en/CF170D](http://www.igus.de/en/CF170D)

IGUS® CHAINFLEX® CF170D

Speed / acceleration $FL_G$	max. 20 [m/s] / max. 200 [m/s²]
Speed / acceleration $FL_B$	max. 3 [m/s] / max. 6 [m/s²]
Gliding speed / acceleration (maximum)	max. 10 [m/s] / max. 50 [m/s²]
Material - permitted temperature °C	igumid G / -40° to +130° C
Flammability class, igumid G	VDE 0304 IIC UL94 HB

**Technical Data**



Details of material properties  
 ► page 1.38



Zipper E-Tubes  
 Inner height: 17 mm

Phone +49- (0) 22 03-96 49-800  
 Fax +49- (0) 22 03-96 49-222



► page 4.5



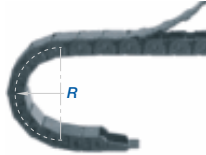
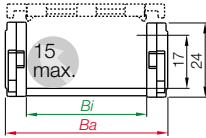

**Series R15 E-Tube - zip-open along the outer radius**

Part No.	Bi [mm]	Ba [mm]	R [mm]	Bending Radii	Weight [kg/m]
R15.025. .0	25	36	063	075 100 110 125 145 180	~ 0,40
R15.063. .0	63	76	063	075 100 110 125 145 180	~ 0,63
R15.080. .0	80	94	063	075 100 110 125 145 180	~ 0,70

more widths upon request

Supplement part no. with required radius (R) Example: R15.025.063.0

0 = standard color, other colors ▶ page 1.39 · Pitch = 30,5 mm/link - Links/m = 33

Part No. structure

R15. 025. 063. 0



Zipper | **Series R15** | Accessories | Interior Separation

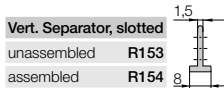

**Option 1: Vertical Separators**

- Vertical Separators are used if a vertical subdivision of the E-Chain® interior is required
- Standard subdivision with Vertical Separator, slotted 154, for combinations with Full-Width Shelf 111.X
- By standard Vertical Separators are assembled every other chain link.

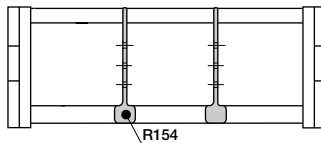

**Option 2: Full-Width Shelves**

- For applications involving many thin cables with similar or identical diameters

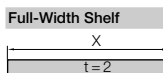
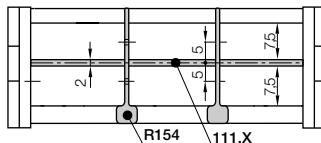

Width X [mm]	Part No. unassembled	Part No. assembled
015	110.15	111.15
025	110.25	111.25
038	110.38	111.38
050	110.50	111.50

Width X [mm]	Part No. unassembled	Part No. assembled
063	110.63	111.63
080	110.80	111.80
100	110.100	111.100

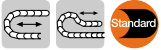

**The Standard - option polymer - pivoting**

- Recommended for unsupported and gliding applications
- Well suited for tight installation conditions
- Available with or without strain relief tiwrap plates
- Variable traverse angle for flexible assembly

Moving end with bore  
(outer link) 10...3P(Z)

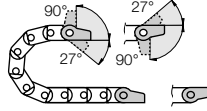

10...2P(Z) Fixed end  
with pin (inner link)

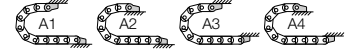

Possible installation conditions for assembled mounting brackets ► Order example "preassembled" below



**Option polymer - locking**

- Recommended for unsupported and gliding applications
- Furthermore:**
- At very high speed and/or acceleration
  - If space is limited for height (the  $H_f$  measurement)

Moving end with bore  
(outer link) 10...1P(Z)

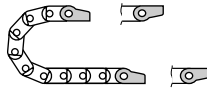

10...2P(Z) Fixed end  
with pin (inner link)

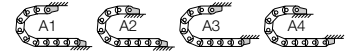

Possible installation conditions for assembled mounting brackets ► Order example "preassembled" below

10...3P(Z) Standard! (pivoting)  
10...1P(Z) (locking)

Moving end

For E-chain®:  
R15.015. to R15.050.

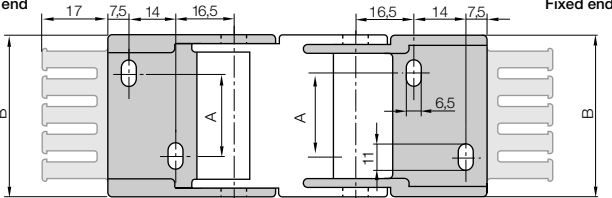

For E-chain®:  
R15.063 to R15.100.

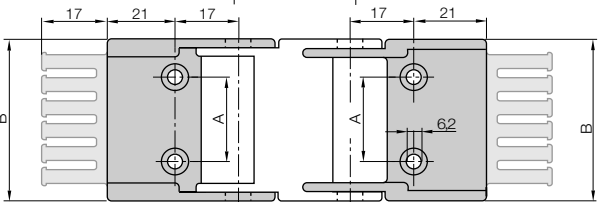

Für E-chain®	Part No. full set with tiwrap plate	Part No. full set without tiwrap plate	Number of teeth	Dim. A [mm]	Dim. B [mm]
R15.025.	▶ 1025. [ ] PZ	1025. [ ] P	3	10	35,5
R15.063.	▶ 105. [ ] PZ	105. [ ] P	6	48	75,0
R15.080.	▶ 106. [ ] PZ	106. [ ] P	8	65	92,0

Please add the Part No. with the requested index - 32 for the pivoting configuration e.g. 1015. [32] PZ or 12 for the locking configuration e.g. 1015. [12] PZ. For the preassembled mode please add the index [A1]...[A4] e.g. 1015. [32] PZ [A1]. \*upon request

**Dimensions and order configurations**

Strain relief is possible on the moving end and/or the fixed end.

Part No. structure (pivoting)



A... must be indicated on preassembled configurations with assembled tiwrap plates  
Full set pivoting = 32  
Mounting brackets for selected chain type

Full set, for both ends:

[1015. [32] PZ] +tiwrap plate

Single-part order:

[1015. [3] PZ] +tiwrap plate

Mounting bracket with bore

[1015. [2] PZ] +tiwrap plate

Mounting bracket with pin

Part No. structure (locking)



A... must be indicated on preassembled configurations with assembled tiwrap plates  
Full set star = 12  
Mounting brackets for selected chain type

Full set, for both ends:

[1015. [12] PZ] +tiwrap plate

Single-part order:

[1015. [1] PZ] +tiwrap plate

Mounting bracket with bore





[1015. [2] PZ] +tiwrap plate

Mounting bracket with pin

Quicksnap + Quickfix upon request



$B_a$  = Outer width E-Chains® / E-Tube  
 $B_i$  = Inner width E-Chains® / E-Tube  
 $h_a$  = Outer height E-Chains® / E-Tube  
 $H_{Ri}$  = Inner trough height  
 $H_{Ra}$  = Outer trough height  
 $B_{Ri}$  = Inner trough width ► depends on dim.  $B_a$   
 $B_{Ra}$  = Outer trough width  
 $n_{Mon}$  = Number of installation sets (left/right)  
 $n_{Ri}$  = Number of troughs sets (left/right)  
 $H_{Ri} \geq 2 \cdot h_a$   
 $B_{Ri} \geq B_a + 4$

 = Guide trough set     = Glide bar  
 = Installation set "Basic"     = C-profile

### Installation set "Basic" with C-profile

Bottom Clamp attached optionally inwards or outwards

R15.5.063.0 ► Order example

	$B_{Ri}$ [mm]	Part No.	
		attached inwards	attached outwards
.025	40	-	960.30.150
.063	80	-	960.30.175
.080	98	960.30.150	960.30.200

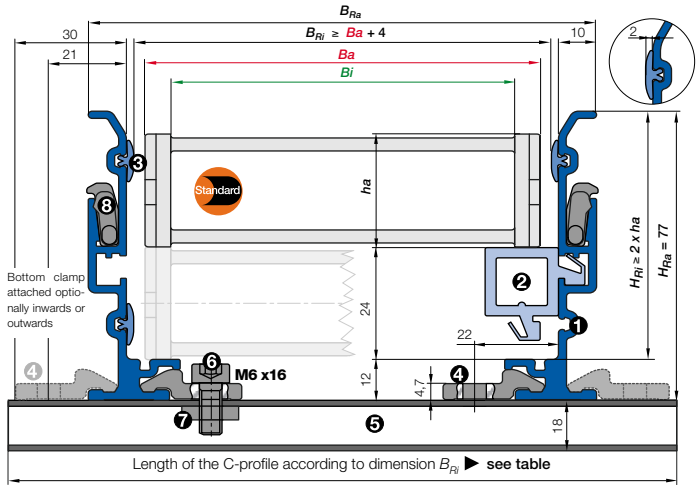

**● Components, trough "Basic":** ① Trough side parts, aluminum, 2 m ② Glide bar, plastic, 2 m ③ Glide strips, plastic, 2 m (without glide strips on request)  
**● Components, installation set "Basic":** ④ Bottom clamp, aluminum ⑤ C-profile, steel galvanized ⑥ Screw M6 x16 ⑦ Sliding nut M6 ⑧ Interface connector, plastic



**Order example: Length of travel 30 m - Center mounted for Series R15.5.080.0 with  $B_{Ri} = 98$**

Guide trough set (set of 2 trough side parts, incl. glide strips) **without** glide bar

**Order text: 16 m guide trough without glide bar (8 x 2 m sections) Part No. 970.30.SL**

Guide trough set (set of 2 trough side parts, incl. glide strips) **with** glide bar

**Order text: 16 m guide trough with glide bar (8 x 2 m sections) Part No. 970.31.SL**

Installation set "Basic" complete (guide trough-sets + 1)

**Order text: 17 installation sets "Basic" Part No. 960.30.125**

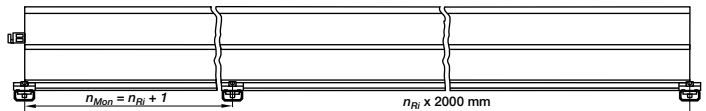

Principle sketch: Number of installation sets to be installed = **Number of trough sections + 1**

### Other guide trough systems



"Single-piece steel guide troughs" with trough glide surface ► **chapter 9**



"Snap in trough" easy and fast assembly, favorable price due to simple structure, narrow design ► **chapter 9**

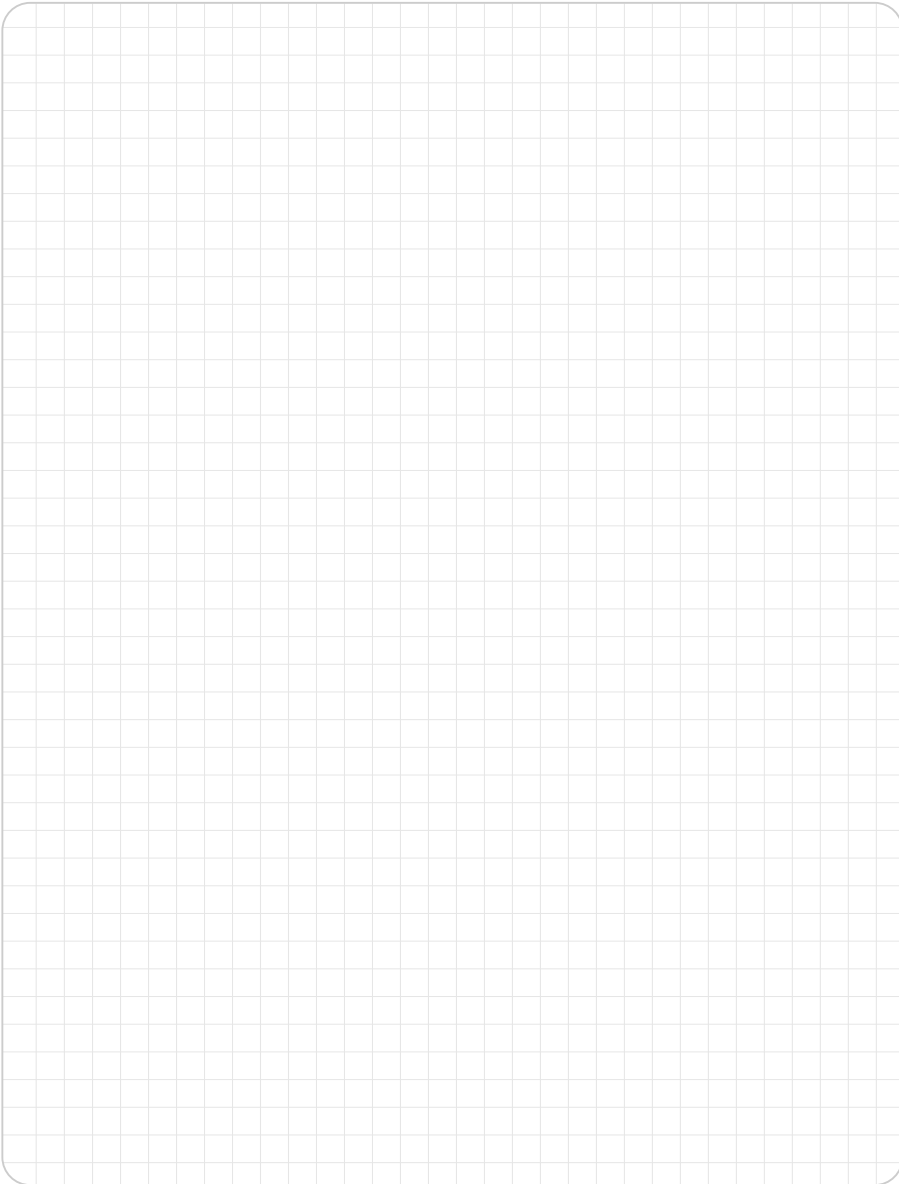

Zipper E-Chains®  
Inner height: 17 mm

Tel. +49- (0) 22 03-96 49-800  
Fax +49- (0) 22 03-96 49-222



► Kapitel 9



► Seite 4.5

## Low cost, oil-proof, shielded - Chainflex® CF211 - measuring system cable

TIP!

oil-proof in accordance with VDE, flamae-retardant, PVC outer jacket, bending radius 10xd  
Further information: [www.igus.de/en/CF211](http://www.igus.de/en/CF211)

IGUS® CHAINFLEX® CF211



## Zipper | E-Tubes | Series R17

● ● ● Price index

**Clean-Room**

Upon request: Cleanroom Class 1 (ISO class 3) tested by the Dryden Engineering Company, California

**UL**

UL94-V2 classifications upon request



Low-noise



"Zipper-fast" opening and closing



### When to use the Series R17:

- If extremely quick, zipper-like access to cables is required
- If chip protection is required
- If quick, easy insertion of cables with preassembled connectors is required
- If aesthetic design is required



### When not to use it:

- If cable installation without opening lids is possible
- ▶ Series E16 Easy Chain®, page 3.42

- ① "Zipper-fast" opening and closing
- ② Small pitch for low-noise, smooth operation
- ③ For high acceleration
- ④ Zipper lids can be separated and joined at each chain link
- ⑤ Mounting bracket with integrated strain relief
- ⑥ Smooth exterior and interior
- ⑦ Large pivot pins for long service life
- ⑧ Also available as "Zipper" E-Chain® Series 17 ▶ page 4.24

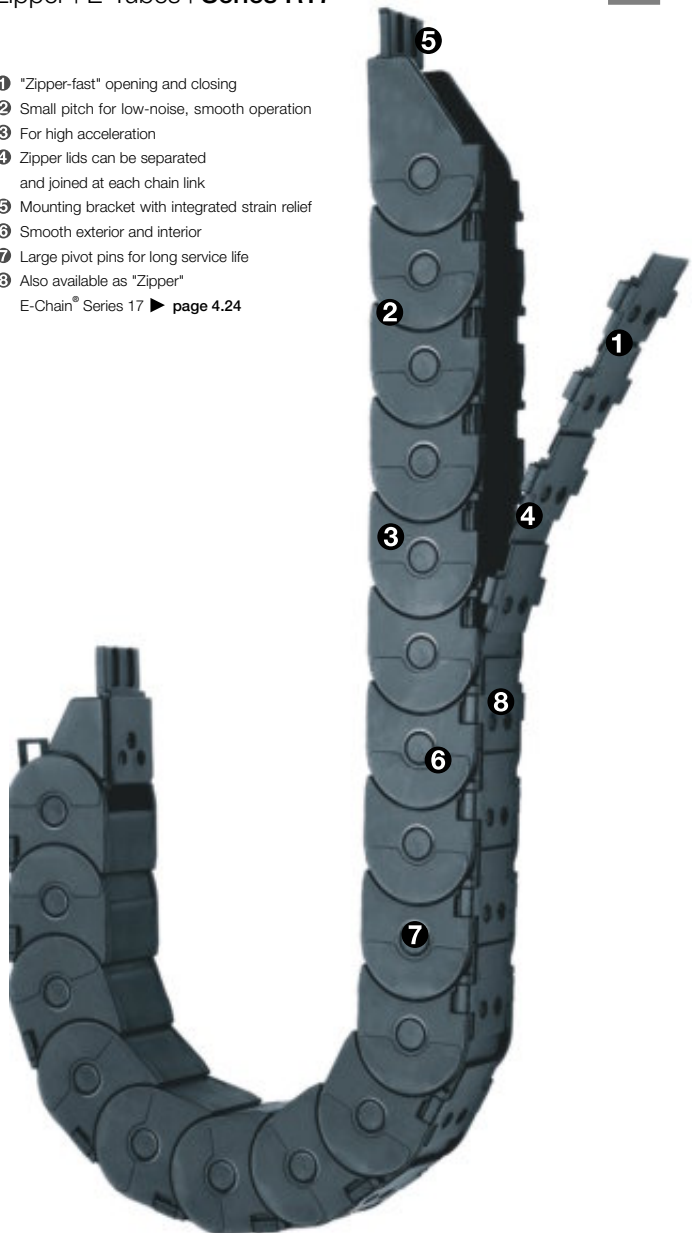

### Order example complete E-Tube

Please indicate chain-lengths or number of links **Example: 1 m or 33 links**

1 m **R17.025.063.0**

**E-Chain®**

with 2 separators **R172** assembled every 2<sup>nd</sup> link

**Interior separation**

1 set **117.025.12PZ**

**Mounting bracket**

**Unsupported length**

$FL_G$  = with straight upper run

$FL_B$  = with permitted sag

Further information ► **Design, page 1.12**

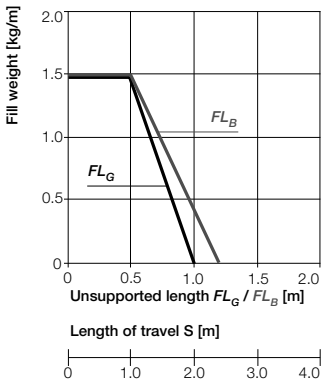
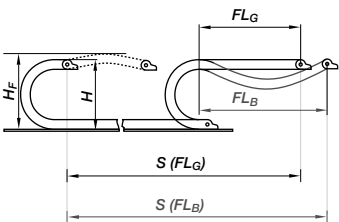

- $S$  = Length of travel
- $R$  = Bending radius
- $H$  = Nominal clearance height
- $H_F$  = Required clearance height
- $D$  = Overlength E-Chain® radius in final position
- $K = \pi \cdot R + \text{"safety"}$

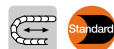
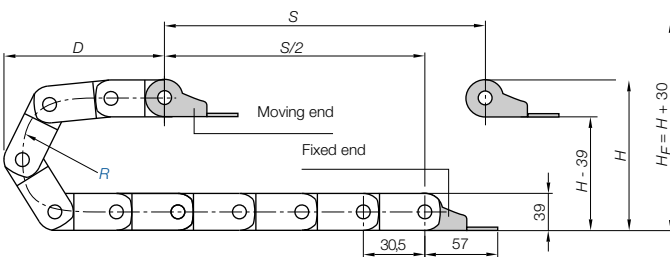

**Short travels - unsupported**

Unsupported E-Chains® feature positive camber over short travels. This must be accounted for when specifying the clearance height  $H_F$ . Please consult igus® if space is particularly restricted.

Pitch = 30,5 mm/link    Links/m = 33 (1.006,5 mm)    Chain length =  $S/2 + K$

$R$	063	075	100	125
$H$	165	189	239	289
$D$	115	130	155	180
$K$	275	305	395	475

The required clearance height:  
 $H_F = H + 30$  mm  
 (with 1,0 kg/m fill weight)

**High resistance to oil and UL, for example Chainflex® CF7 PUR-control cable**

**TIP!**

PUR-outer jacket, oil-resistant and coolant-resistant, flame-retardant, notch-resistant, hydrolysis-resistant and microbe-resistant. Further information: [www.igus.de/en/CF7](http://www.igus.de/en/CF7)

IGUS® CHAINFLEX® CF7

Speed / acceleration $FL_G$	max. 20 [m/s] / max. 200 [m/s]
Speed / acceleration $FL_B$	max. 3 [m/s] / max. 6 [m/s]
Gliding speed / acceleration (maximum)	max. 10 [m/s] / max. 50 [m/s]
Material - permitted temperature °C	igumid G / -40° to +130° C
Flammability class, igumid G	VDE 0304 IIC UL94 HB

**Technical Data**



Details of material properties  
 ► page 1.38



Zipper E-Tubes  
 Inner height: 32 mm

Phone +49- (0) 22 03-96 49-800  
 Fax +49- (0) 22 03-96 49-222



► page 4.5



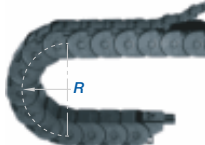
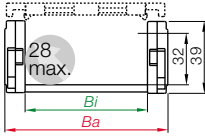

Part No. structure

R17. 025. 063. 0



**Series R17 E-Chain® - zip-open along outer radius**

Part No.	Bi [mm]	Ba [mm]	R [mm]	Bending Radii			Weight [kg/m]
R17.015. .0	15	26	063	075	100	125	~ 0,52
R17.025. .0	25	36	063	075	100	125	~ 0,59
R17.063. .0	63	76	063	075	100	125	~ 0,83

more widths upon request

Supplement part no. with required radius (R) Example: R17.025. 063. 0

0 = standard color, other colors ► page 1.39 - Pitch = 30,5 mm/link - Links/m = 33



Zipper | **Series R17 | Accessories | Interior Separation**

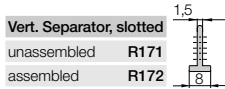

Vert. Separator, slotted  
unassembled R171  
assembled R172

**Option 1: Vertical Separators**

- Vertical Separators are used if a vertical subdivision of the E-Chain® interior is required
- Standard subdivision with Vertical Separator, slotted 172, for combinations with Full-Width Shelf 111.X
- By standard Vertical Separators are assembled every other chain link

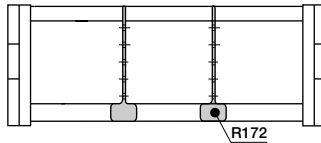

**Option 2: Full-Width Shelves**

- For applications involving many thin cables with similar or identical diameters.

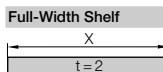
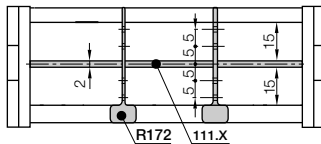

Full-Width Shelf

Width X [mm]	Part No. unassembled	Part No. assembled
015	110.15	111.15
025	110.25	111.25
038	110.38	111.38
050	110.50	111.50

Width X [mm]	Part No. unassembled	Part No. assembled
063	110.63	111.63
080	110.80	111.80
100	110.100	111.100



**Polymer - locking**

- One-piece mounting bracket
- Corrosion-resistant
- Available preassembled
- Inner and outer attachment possible
- Available with or without integrated strain relief tiwrap plates

Moving end with bore (outer link) 117...1P(Z)

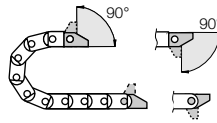

117...2P(Z) Fixed end with pin (inner link)



Possible installation conditions for assembled mounting brackets ▶ Order example "preassembled" below

117...1P(Z)

Moving end

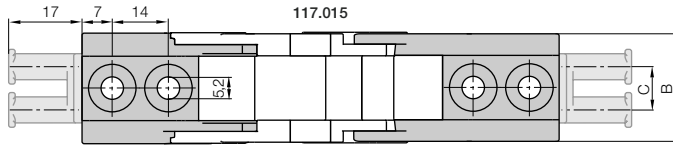

117...2P(Z)

Fixed end

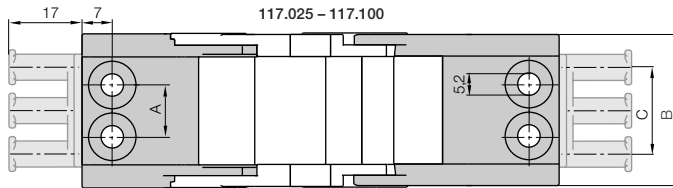

**Dimensions and order configurations**

Strain relief is possible on the moving end and/or the fixed end.

**Part No. structure**

117. 015. 12 PZ A1

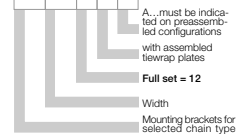

**Full set, for both ends:**

117.015.12 PZ +tiwrap plate

**Single-part order:**

117.015.1 PZ +tiwrap plate

Mounting bracket **with bore**

117.015.2 PZ +tiwrap plate

Mounting bracket **with pin**

For E-chain*	Part No. full set with tiwrap plate	Part No. full set without tiwrap plate	Number of teeth	Dim. A [mm]	Dim. B [mm]	Dim. C [mm]
R17.015. ▶	117.015.12 PZ	117.015.12 P	2	–	25,7	10
R17.025. ▶	117.025.12 PZ	117.025.12 P	3	12	35,7	20
R17.063. ▶	117.063.12 PZ	117.063.12 P	6	48	73,7	50

For the **preassembled** mode please add the index **A1**...**A4** Example: 117.015.12 PZ**A1**



**Quicksnap** - the complete, detachable mounting unit, available upon request



**Quickfix** - mounting bracket with dowel, available upon request

**Additional Features**

Phone +49- (0) 22 03-96 49-800  
Fax +49- (0) 22 03-96 49-222





# System E2



E2/000



E2 mini



E2 micro



**E2 micro**

**E2 micro ▶ from page 5.6**

- E-Chains® for smallest inner heights
- One-piece E-Chains®
- Space-saving ratio of inner-to-outer dimensions
- Inner heights 5 - 15 mm



**E2 mini**

**E2 mini ▶ from page 5.34**

- Small and medium sizes
- Small pitch for smooth running
- One and two-piece E-Chains®
- Inner heights 18 - 41 mm



**E2/000**

**System E2/000 ▶ from page 5.78**

- E2 Standard - as E-Chain®, half E-Tube and fully enclosed E-Tube available
- New snap-open mechanism, snap-open on left or right
- Lightning fast with thumb catch - secure fit without additional locking devices
- Excellent mechanical stability, long life due to design and material
- Inner heights 21 - 45 mm

**E2 micro and mini** - Smallest and small E-Chains® for tight spaces with interior heights from 5 to 41 mm. The 2-piece E2 micro and mini E-Chains® are very lightweight, easy to assemble and cost-efficient. Many accessories are available. Perfect to use for short travels and unsupported applications ▶ **E2 micro page 5.6 and E2 mini page 5.34.**

**System E2/000** - Standard medium sized E-Chains® and E-Tubes with inner heights from 21 to 45 mm. To open from left or right side, as E-Chain®, half and fully closed E-Tube available. Very easy to assemble and cost-efficient due to the 2-piece design. E-Chains® and E-Tubes with excellent mechanical stability and lifetime. Wide range of separator- and strain relief program. Suitably for long (gliding) travels and unsupported applications. Many accessories are available ▶ **page 5.78**

### Comparison of the main characteristics

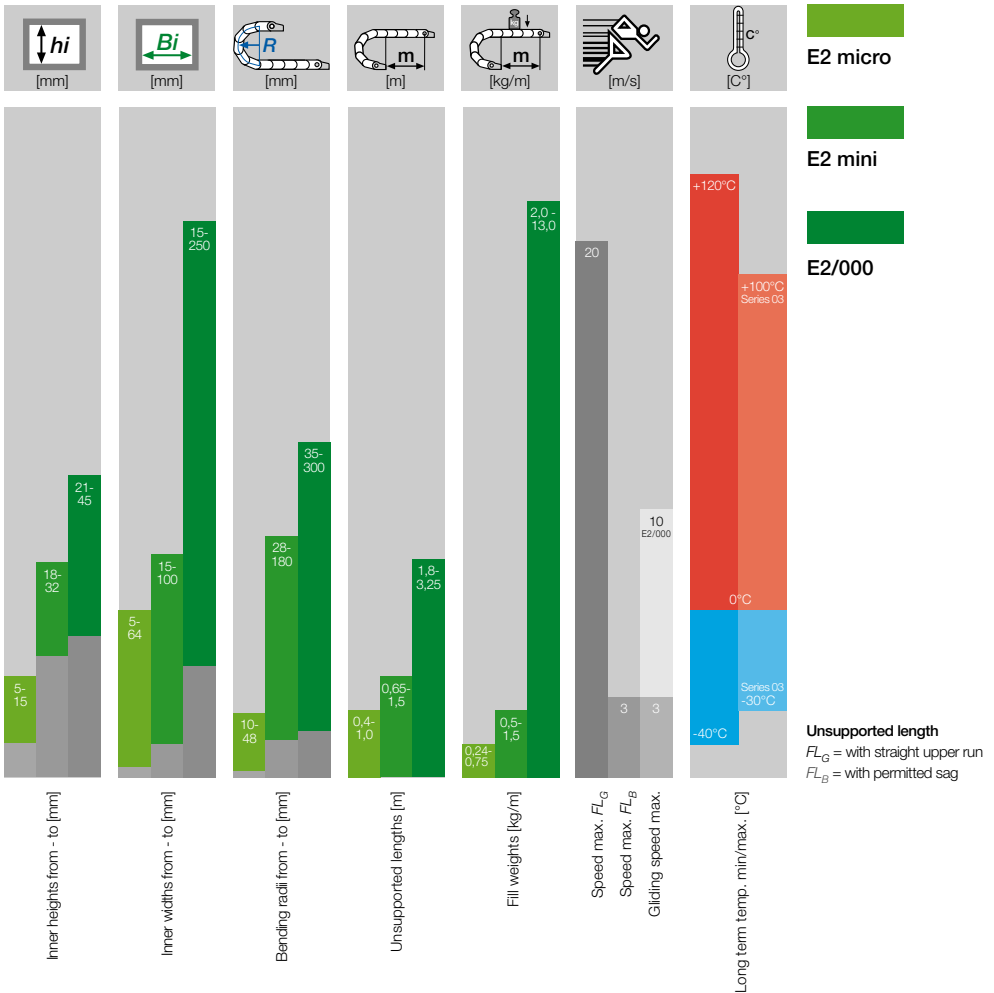



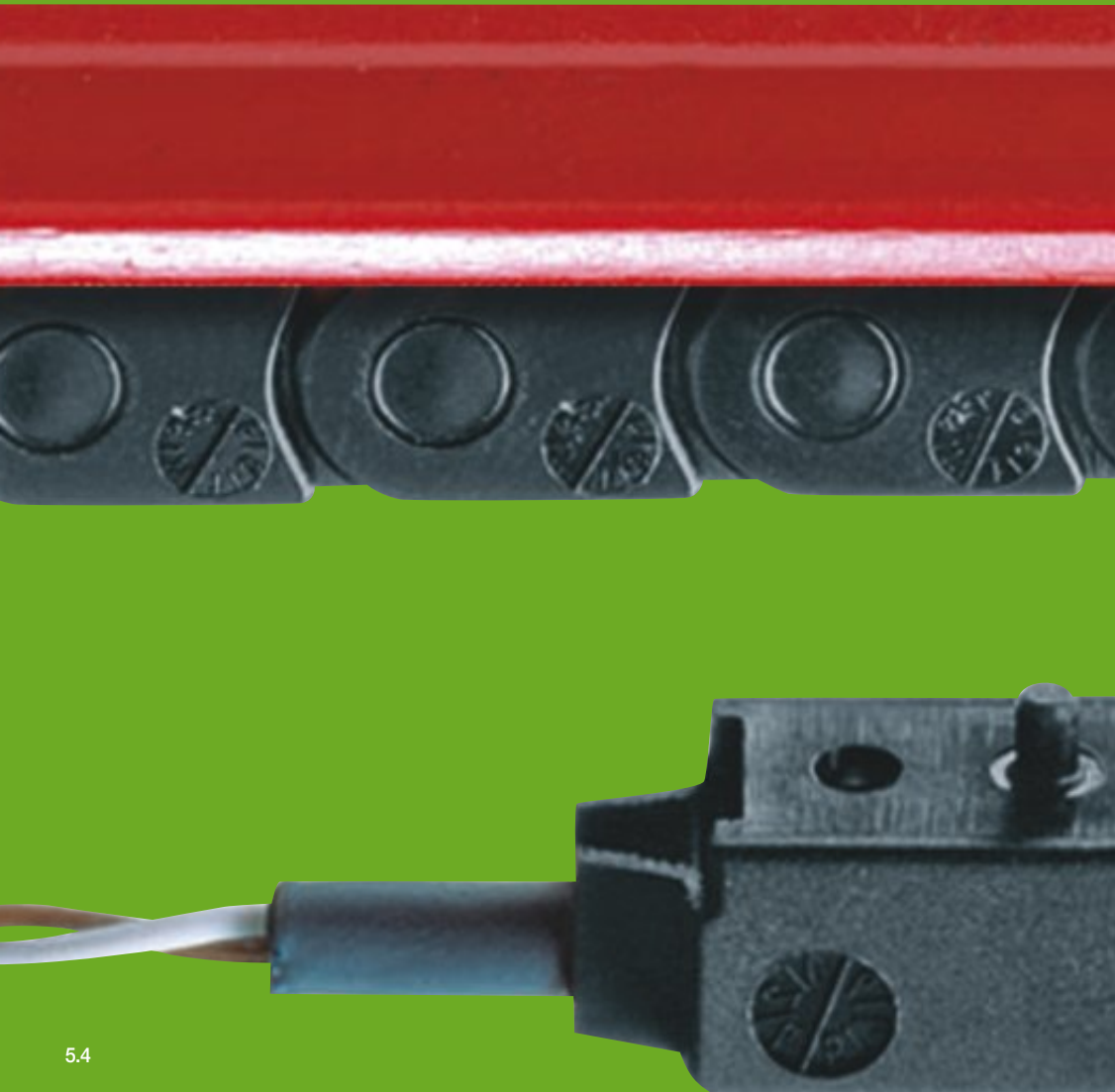

# E2 micro



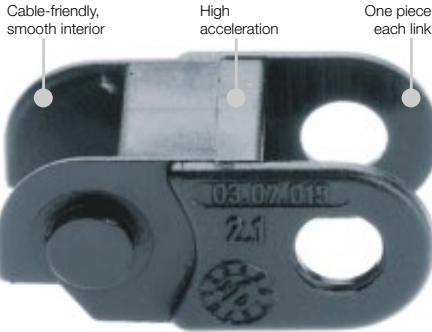

**One-piece E-Chains®**

- Smallest inner heights
- Mounting brackets optional with strain relief
- Quicksnap and Quickfix available
- Small pitch for smooth running
- Cable-friendly, smooth interior
- Low weight
- Large pins for longer life
- Space-saving ratio of inner-to-outer dimensions
- You can find more technical data about the material, chemical resistance, temperatures ► **chapter design, from page 1.38**

**Opening-principle**



Only one-piece closed links available

**Dimensioning**

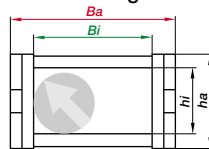

**Bending radius**

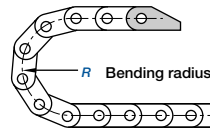

**Part No. structure**

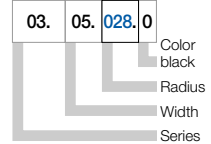

**Selection table**

Series	Inner height <i>hi</i> [mm]	Inner width <i>Bi</i> [mm]	Outer width <i>Ba</i> [mm]	Outer height <i>ha</i> [mm]	Bending radius <i>R</i> [mm]	Unsupported length max. [m]	Page
03	5,0	5 - 10	8,7 - 13,7	8,0	10 - 28	0,40	5.10
04	7,0	7 - 30	12,0 - 35,0	10,0	15 - 48	0,50	5.14
045	10,3	6 - 64	12,0 - 70,0	12,5	18 - 38	0,50	5.18
05	10,0	6 - 64	10,0 - 68,0	12,0	18 - 38	0,50	5.22
06	10,5	6 - 64	12,5 - 71,0	15,0	18 - 38	0,60	5.26
08	15,0	10 - 50	18,2 - 58,2	19,3	28 - 48	1,00	5.30

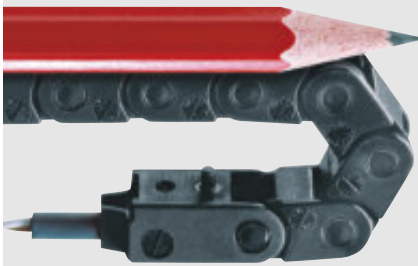

**Smallest inner heights and bending radii**

One-piece micro E-Chains® with inner heights from 5 mm and bending radii from 10 mm for smallest spaces. Due to the lightweight design, the igus® micro-series are also suitable for high speed applications.

## Main characteristics at a first glance

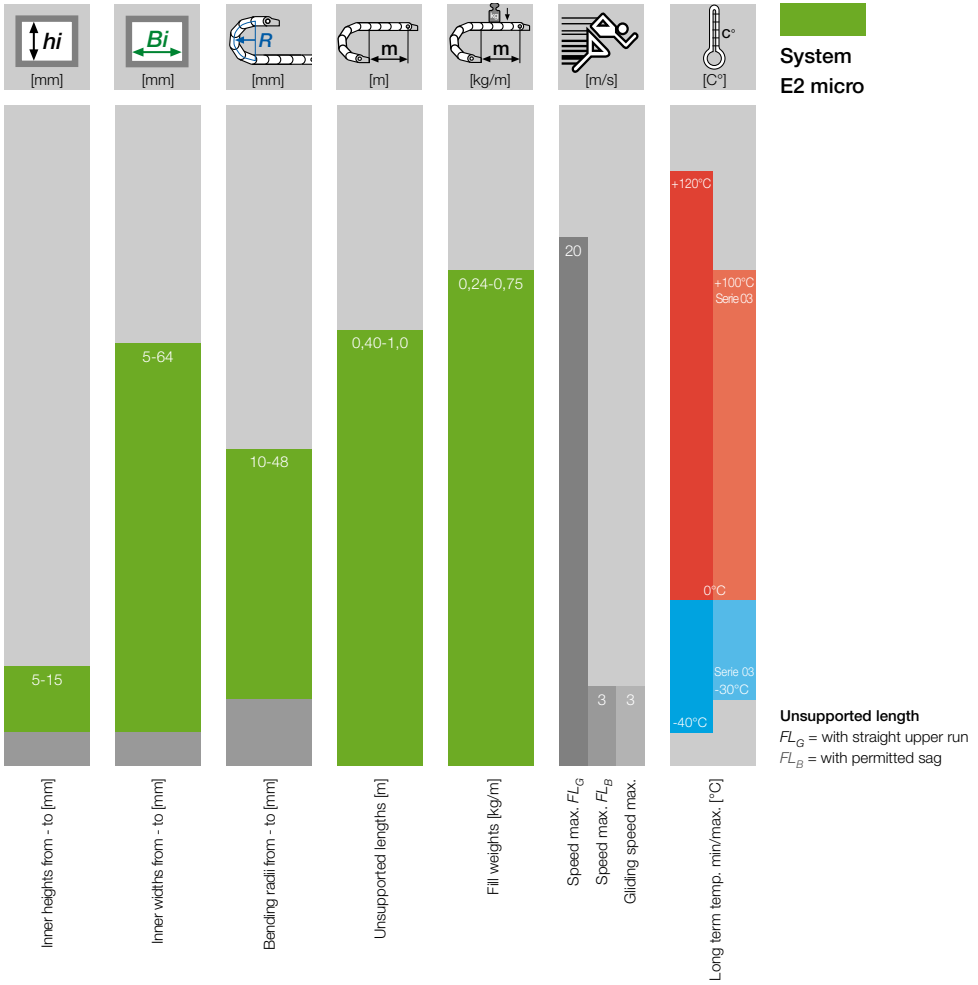

### Additional quality features - E2 micro



IPA Qualification Certificate:  
Cleanroom test upon request



Special equipment: Electrically conductive  
ESD/ATEX version upon request



UL94 - V2 classifications for Series 03  
and Series 04 (others upon request)



iF-Design Award -  
for E2 micro - Series 05

► Next page: Find application examples and assembly instructions

E2 micro are very small, one-piece, light-weight E-Chains® ideal for high dynamic applications. E2 micro E-Chains® are not openable and very cost effective and available in thousands of variations. igus® also offers a host of accessories and fixation options. "Upgrades" to openable versions are available for many types. In these cases they are interchangeable and offer by this more service as repair kits or new installations.

**Typical industries and applications**

- General machinery
- Models (micro E-Chains®)
- Construction machinery
- Vehicles
- Furniture
- Electric cabinets
- General machinery - slow movements
- Electric equipment
- Vending machines

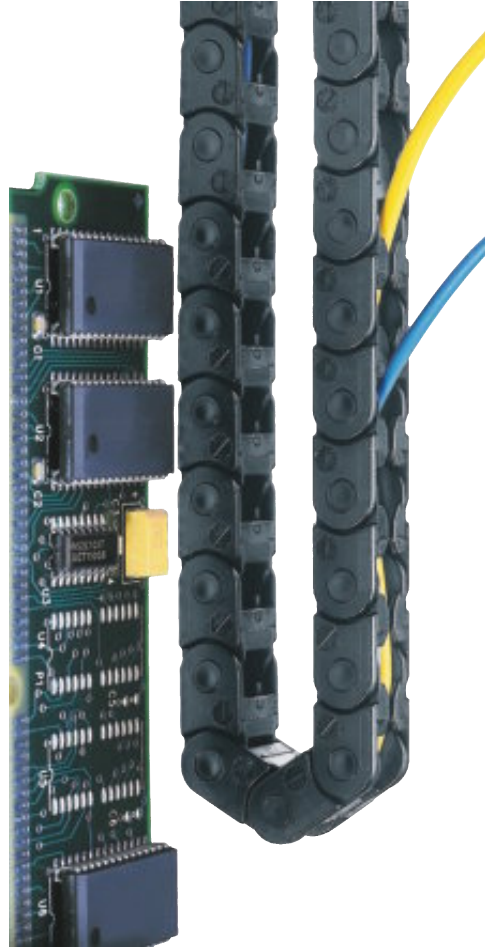

Smallest high - For example Series 03: 5 mm inner height



Sliding door in train - UL 94-V2 version



igus® E2 micro E-Chains® are robust for standing applications



Sliding door in subway with igus® Chainflex® CF9 cable for smallest spaces

**Assembling** | E2 micro



Twist and click

**Separate** | E2 micro



Twist and separate

**Speciality** | E2 micro



igus® micro E-Chains® - for smallest bending radii with Chainflex® CF98 and CF99 - 4 x d!





● ● ● Price index



**IPA Qualification Certificate:**  
Cleanroom test  
upon request



**Special equipment:**  
Electrically conductive ESD/ATEX  
version upon request



**UL94-V2 classifications**  
upon request



Easy to assemble and to disassemble



**When to use the Series 03:**

- If quiet operation is required
- If price is an issue
- If snap-open links are not necessary
- If small bending radii are required



**When not to use it:**

- If snap-open links are required
  - ▶ Series 047 Zipper, page 4.6
- If quick insertion of cables with preassembled connectors is required
  - ▶ Series E04 Easy Chain®, page 3.8

- ❶ igus® smallest E-Chain® - interior dimensions 5 x 5 mm
- ❷ Very light weight - low price
- ❸ Mounting bracket with integrated strain relief
- ❹ Dirt-repellent exterior
- ❺ Patented "push-button principle" for better stability
- ❻ One-piece, non snap-open E-Chain®
- ❼ Available as "Easy Type", easy to be filled
  - ▶ page 3.6



**Order example complete E-Chain®**

Please indicate chain-lengths or number of links **Example: 1 m or 100 links**

1 m 03.05.028.0



E-Chain®

1 set 03.05.12Z



Mounting bracket

**Unsupported length**

$FL_G$  = with straight upper run

$FL_B$  = with permitted sag

Further information ► **Design, page 1.12**

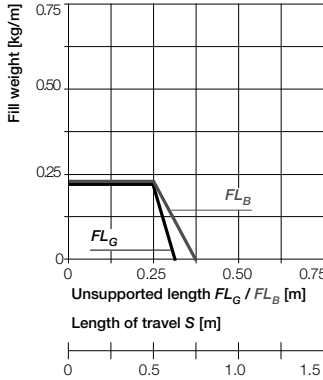
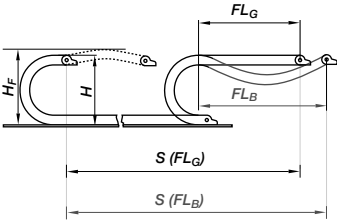

- $S$  = Length of travel
- $R$  = Bending radius
- $H$  = Nominal clearance height
- $H_F$  = Required clearance height
- $D$  = Overlength E-Chain® radius in final position
- $K = \pi \cdot R + \text{"safety"}$

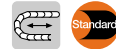
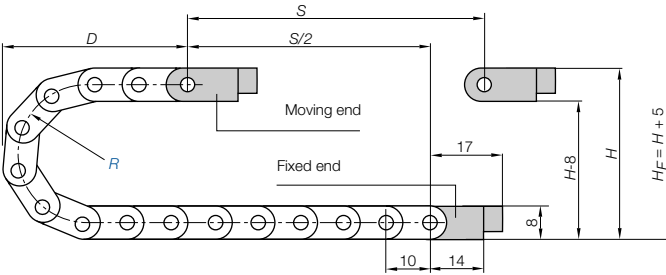

**Short travels - unsupported**

Unsupported E-Chains® feature positive camber over short travels. This must be accounted for when specifying the clearance height  $H_F$ . Please consult igus® if space is particularly restricted.

**Pitch = 10 mm/link    Links/m = 100 (1.000 mm)    Chain length =  $S/2 + K$**

$R$	010	012	015	018	028
$H$	30	34	40	46	66
$D$	25	27	30	33	43
$K$	55	60	70	80	110

The required clearance height:  
 $H_F = H + 5$  mm  
 (with 0,1 kg/m fill weight)



E2 micro  
Inner height: 5 mm

Phone +49- (0) 22 03-96 49-800  
Fax +49- (0) 22 03-96 49-222



**Chainflex® CF98 - tested 30 million strokes with 4xd**

TPE outer jacket, oil- and bio-oil-resistant, PVC and halogen-free, low-temperature-flexible  
 Further information: [www.igus.de/en/CF98](http://www.igus.de/en/CF98)



Speed / acceleration $FL_G$	max. 20 [m/s] / max. 200 [m/s²]
Speed / acceleration $FL_B$	max. 3 [m/s] / max. 6 [m/s²]
Gliding speed / acceleration (maximum)	max. 3 [m/s] / max. 10 [m/s²]
Material - permitted temperature °C	igumid NB / -30° up to +100° C
Flammability class, igumid G	VDE 0304 IIC UL94

**Technical Data**



Details of material properties  
 ► chapter 1



► page 5.9

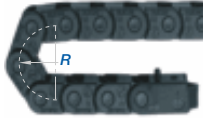
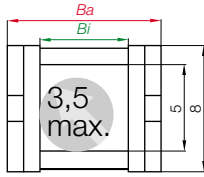

Part No. structure

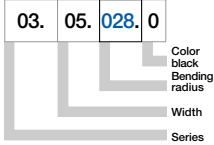

## Series 03 E-Chain® - non snap-open

Part No.	Bi [mm]	Ba [mm]	R [mm]	Bending radii	Weight [kg/m]
03.05.□.0	5	8,7	010	012 015 018 028	~ 0,04
03.07.□.0	7	10,7	010	012 015 018 028	~ 0,05
03.10.□.0	10	13,7	010	012 015 018 028	~ 0,06

Supplement Part No. with required radius. Example: 03.05.028.0

0 = standard color, other colors ► page 1.39 · Pitch = 10 mm/link - Links/m = 100





**Polymer, one-piece**

- One-piece mounting bracket
- Corrosion-resistant
- Available preassembled
- Adapter plate for rapid installation

Moving end with bore  
(outer link) 03...1Z

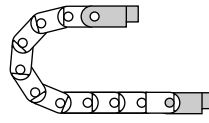

03...2Z Fixed end  
with pin (inner link)



Possible installation conditions for assembled mounting brackets ▶ Order example "preassembled" below

03...1Z  
Moving end

03...2Z  
Fixed end

**Dimensions and order configurations**

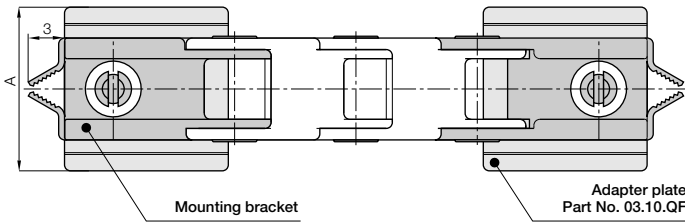

For E-Chain*	Part No. full set	Dim. A [mm]
03.05. ▶	03.05. <span style="border: 1px solid black; padding: 0 2px;">12Z</span>	8,7
03.07. ▶	03.07. <span style="border: 1px solid black; padding: 0 2px;">12Z</span>	10,7
03.10. ▶	03.10. <span style="border: 1px solid black; padding: 0 2px;">12Z</span>	13,7

For the **preassembled** mode please add the index A2 or A4 e.g. 03.05. 12Z A2

**03.10.QF = Adapter plate for all sizes**

The adapter has broken edges, so that it can be adapted to the respective chain width. It is not absolutely necessary for attaching the mounting brackets. The mounting brackets can also be screwed on without the adapter plate.

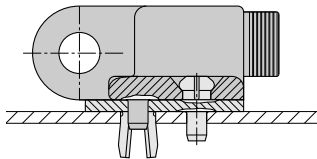

**Part No. structure**

03. 05. 12Z A2

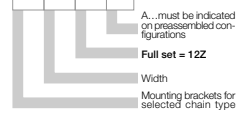

**Full set, for both ends:**

03. 05. 12Z

**Single-part order:**

03. 05. 1Z

Mounting bracket **with bore**

03. 05. 2Z

Mounting bracket **with pin**



Adapter plate for rapid installation, upon request Part No. 03.10.QF

**Additional Features**



● ● ● Price index



IPA Qualification Certificate:  
Cleanroom test  
upon request



Special equipment:  
Electrically conductive ESD/ATEX  
version upon request



UL94-V2 classifications  
upon request



Easy to assemble and to disassemble



When to use the Series 04:

- If quiet operation is required
- If price is an issue
- If snap-open links are not necessary
- If small bending radii are required



When not to use it:

- If snap-open links are required
  - ▶ Series 047 Zipper, page 4.6
- If quick insertion of cables with preassembled connectors is required
  - ▶ Series E04 Easy Chain®, page 3.10

- ① Small E-Chain® - interior dimensions 7 x 7 mm
- ② Very light weight - low price
- ③ Dirt-repellent exterior
- ④ One-piece, non snap-open E-Chain®
- ⑤ Snap-open configuration
- ▶ Series 047 Zipper page 4.6
- ⑥ Easy to fill configuration
- ▶ Series E04 Easy Chain® page 3.10

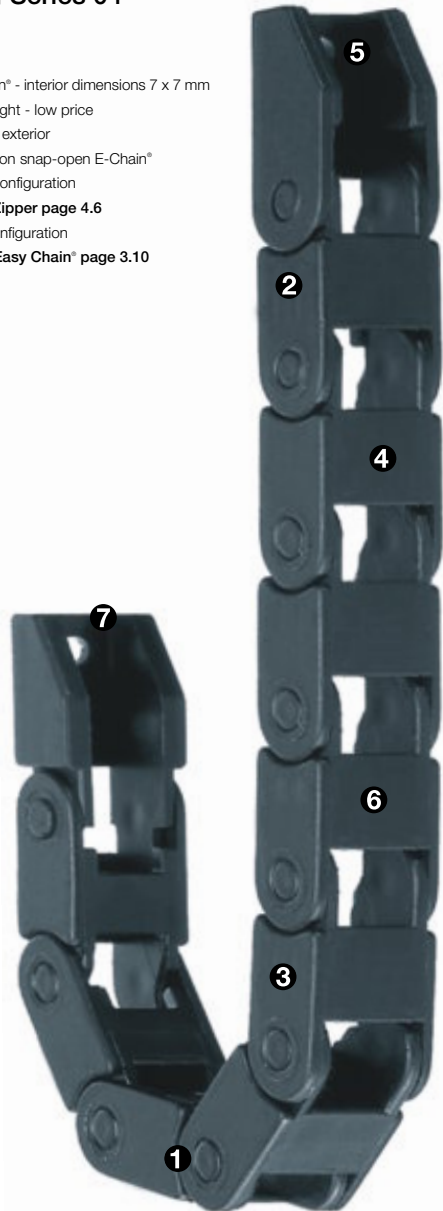

Order example complete E-Chain®

Please indicate chain-lengths or number of links Example: 1 m or 60 links

1 m 04.07.038.0



E-Chain®

1 set 040.07.12



Mounting bracket

**Unsupported length**

$FL_G$  = with straight upper run

$FL_B$  = with permitted sag

Further information ► Design, page 1.12

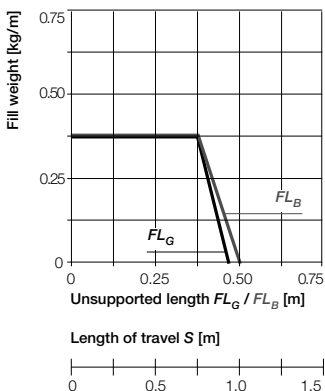
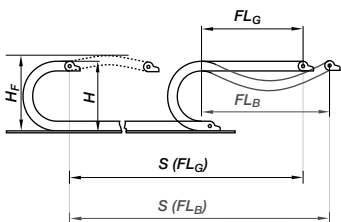

- $S$  = Length of travel
- $R$  = Bending radius
- $H$  = Nominal clearance height
- $H_F$  = Required clearance height
- $D$  = Overlength E-Chain® radius in final position
- $K = \pi \cdot R + \text{"safety"}$

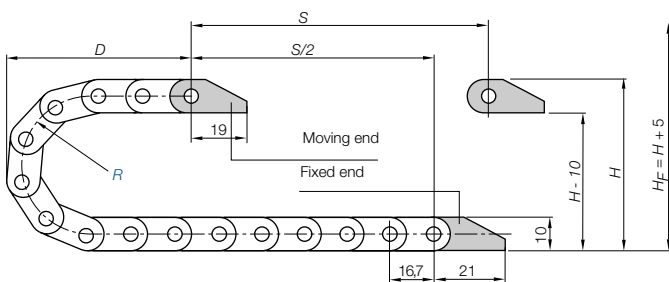

**Short travels - unsupported**

Unsupported E-Chains® feature positive camber over short travels. This must be accounted for when specifying the clearance height  $H_F$ . Please consult igus® if space is particularly restricted.

Pitch = 16,7 mm/link    Links/m = 60 (1.002 mm)    Chain length =  $S/2 + K$

R	015	018	028	038	048
H	42	48	68	88	108
D	40	40	50	60	70
K	80	90	125	155	185

The required clearance height:  
 $H_F = H + 5 \text{ mm}$   
 (with 0,1 kg/m fill weight)



E2 micro  
Inner height: 7 mm

Phone +49- (0) 22 03-96 49-800  
Fax +49- (0) 22 03-96 49-222



**Chainflex® CF98 - tested 30 million strokes with 4xd**

TPE outer jacket, oil- and bio-oil-resistant, PVC and halogen-free, low-temperature-flexible  
 Further information: [www.igus.de/en/CF98](http://www.igus.de/en/CF98)



Speed / acceleration $FL_G$	max. 20 [m/s] / max. 200 [m/s²]
Speed / acceleration $FL_B$	max. 3 [m/s] / max. 6 [m/s²]
Gliding speed / acceleration (maximum)	max. 3 [m/s] / max. 10 [m/s²]
Material - permitted temperature °C	igumid G / -30° up to +100° C
Flammability class, igumid G	VDE 0304 IIC UL94 HB

**Technical Data**



Details of material properties  
 ► page 1.38



► page 5.9



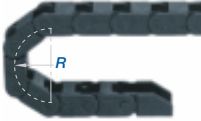
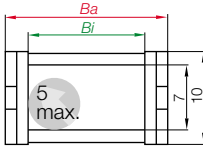

Part No. structure

04.	07.	038.	0
-----	-----	------	---



## Series 04 E-Chain® - non snap-open

Part No.	Bl [mm]	Ba [mm]	R [mm]	Bending radii				Weight [kg/m]
04.07.□.0	7	12	015	018	028	038	048	≈ 0,07
04.10.□.0	10	15	015	018	028	038	048	≈ 0,08
04.16.□.0	16	21	015	018	028	038	048	≈ 0,09
04.20.□.0	20	25	015	018	028	038	048	≈ 0,10
04.30.□.0	30	35	015	018	028	038	048	≈ 0,11

Supplement Part No. with required radius. Example: 04.07.038.0

0 = standard color, other colors ► page 1.39 · Pitch = 16,7 mm/link - Links/m = 60





**Polymer, one-piece**

- One-piece mounting bracket
- Corrosion-resistant
- Available preassembled
- Inner and outer attachment possible

Moving end with bore (outer link) 040...1(PZ)

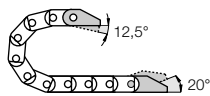

040...2(PZ) Fixed end with pin (inner link)

Possible installation conditions for assembled mounting brackets ▶ Order example "preassembled" below

040...1(PZ)  
Moving end

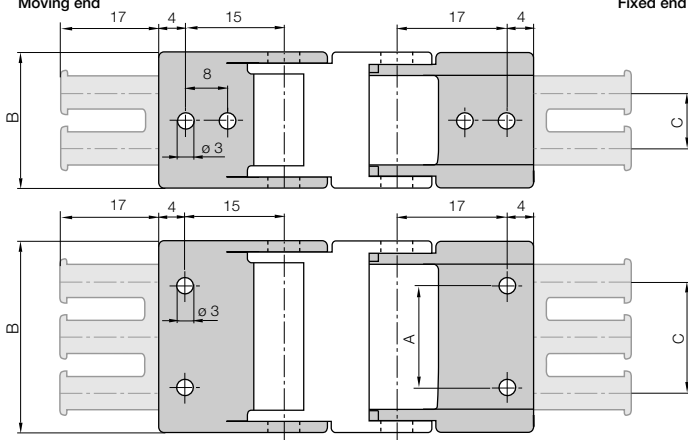

040...2(PZ)  
Fixed end

**Dimensions and order configurations**

040.07.12 - 040.20.12: center bores only  
040.30.12 : outer bores only

For E-Chain®	Part No. full set	Part No. full set zahl	Number of teeth	Dim. A [mm]	Dim. B [mm]	Dim. C [mm]
	tiewrap plate	tiewrap plate				
04.07.	▶ 040.07. 12 PZ	040.07. 12	1	-	13	-
04.10.	▶ 040.10. 12 PZ	040.10. 12	1	-	15	-
04.16.	▶ 040.16. 12 PZ	040.16. 12	2	-	21	10
04.20.	▶ 040.20. 12 PZ	040.20. 12	2	-	25	10
04.30.	▶ 040.30. 12 PZ	040.30. 12	3	22	35	20

**Part No. structure**

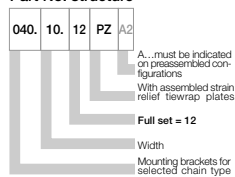

Full set, for both ends:

040. 10. 12 PZ +tiewrap plate

Single-part order:

040. 10. 1 PZ +tiewrap plate

Mounting bracket with bore

040. 10. 2 PZ +tiewrap plate

Mounting bracket with pin

For the preassembled mode please add the index A1 ... A4 e.g. 040.10. 12 PZ A1



**Quicksnap** - the complete, detachable mounting unit, upon request Part No. 040.07.QS

**Quickfix** - mounting bracket with dowel, upon request

**Additional Features**

Phone +49- (0) 22 03-96 49-800  
Fax +49- (0) 22 03-96 49-222





Price index



IPA Qualification Certificate:  
Cleanroom test  
upon request



Special equipment:  
Electrically conductive ESD/ATEX  
version upon request



UL94-V2 classifications  
upon request



Easy to assemble and to disassemble

**When to use the Series 045:**

- If very quiet operation is required
- Aesthetic design
- If excellent service life is required
- If price is an issue
- If small bending radii are required

**When not to use it:**

- If snap-open links are required
  - ▶ **Series 047 Zipper**, page 4.6
- If quick insertion of cables with preassembled connectors is required
  - ▶ **Series E06 Easy Chain®**, page 3.20
- If extra rigidity is required
  - ▶ **Series 06 E2 micro**, page 5.26

- ① Small pitch for very quiet operation
- ② Very light weight -  
ideal for low inertia applications
- ③ Dirt-repellent exterior
- ④ One-piece, non snap-open E-Chain®
- ⑤ Easy to fill configuration
- ▶ **Series E06 Easy Chain®** page 3.20
- ⑥ Snap-open configuration
- ▶ **Series 047 Zipper** page 4.6



Series 046 with full-width shelving 046.16.018.0,  
046.16.028.0, 046.16.038.0 available.  
Width Bi: 16 mm - Radii R: 018, 028, 038

**Order example complete E-Chain®**Please indicate chain-lengths or number of links **Example: 1 m or 77 links**

1 m 045.20.038.0



E-Chain®

1 set 0450.20.12



Mounting bracket

**Unsupported length**

$FL_G$  = with straight upper run

$FL_B$  = with permitted sag

Further information ► Design, page 1.12

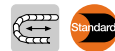
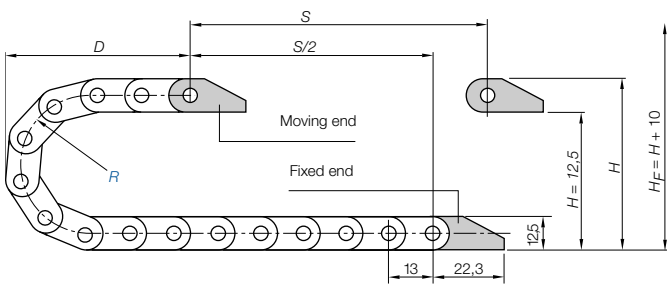
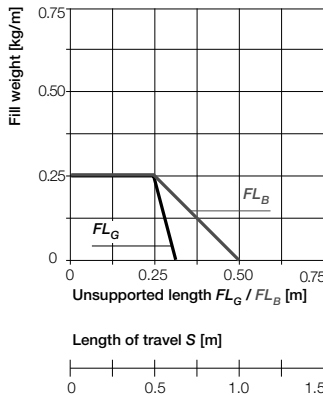
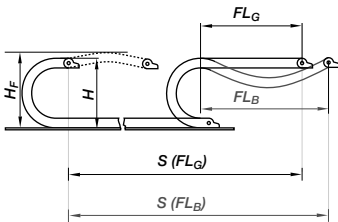

**Short travels - unsupported**

Unsupported E-Chains® feature positive camber over short travels. This must be accounted for when specifying the clearance height  $H_F$ . Please consult igus® if space is particularly restricted.

Pitch = 13 mm/link    Links/m = 77 (1.001 mm)    Chain length =  $S/2 + K$

R	018	028	038
H	52	72	92
D	45	55	65
K	100	140	160

The required clearance height:  
 $H_F = H + 10$  mm  
 (with 0,2 kg/m fill weight)

10,3

E2 micro  
 Inner height: 10,3 mm

Phone +49- (0) 22 03-96 49-800  
 Fax +49- (0) 22 03-96 49-222



**Chainflex® CF98 - tested 30 million strokes with 4xd**

TPE outer jacket, oil- and bio-oil-resistant, PVC and halogen-free, low-temperature-flexible  
 Further information: [www.igus.de/en/CF98](http://www.igus.de/en/CF98)



Speed / acceleration $FL_G$	max. 20 [m/s] / max. 200 [m/s²]
Speed / acceleration $FL_B$	max. 3 [m/s] / max. 6 [m/s²]
Gliding speed / acceleration (maximum)	max. 3 [m/s] / max. 10 [m/s²]
Material - permitted temperature °C	igumid G / -40° up to +130° C
Flammability class, igumid G	VDE 0304 IIC UL94 HB

**Technical Data**



Details of material properties  
 ► page 1.38



► page 5.9

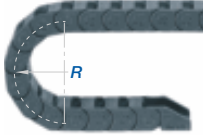
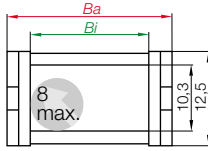

## Series 045 E-Chain® - non snap-open

Part No.	Bi [mm]	Ba [mm]	R [mm]	Bending radii	Weight [kg/m]
045.06.□.0	6	12	018	028 038	~ 0,09
045.10.□.0	10	16	018	028 038	~ 0,10
045.16.□.0	16	22	018	028 038	~ 0,11
045.20.□.0	20	26	018	028 038	~ 0,13
045.30.□.0	30	36	018	028 038	~ 0,16
045.64.□.0	64	70	018	028 038	~ 0,19

Supplement Part No. with required radius. Example: 045.20.□038□.0

0 = standard color, other colors ► page 1.39 · Pitch = 13 mm/link - Links/m = 77

## Part No. structure

045. 20. 038. 0





**Polymer, one-piece**

- One-piece mounting bracket
- Corrosion-resistant
- Available preassembled
- Inner and outer attachment possible

Moving end with bore  
(outer link) 0450...1(PZ)

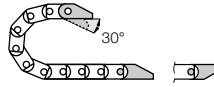

0405...2(PZ) Fixed end  
with pin (inner link)

Possible installation conditions for assembled mounting brackets ▶ Order example "preassembled" below

0450...1(PZ)  
Moving end

0450...2(PZ)  
Fixed end

**Dimensions and order configurations**

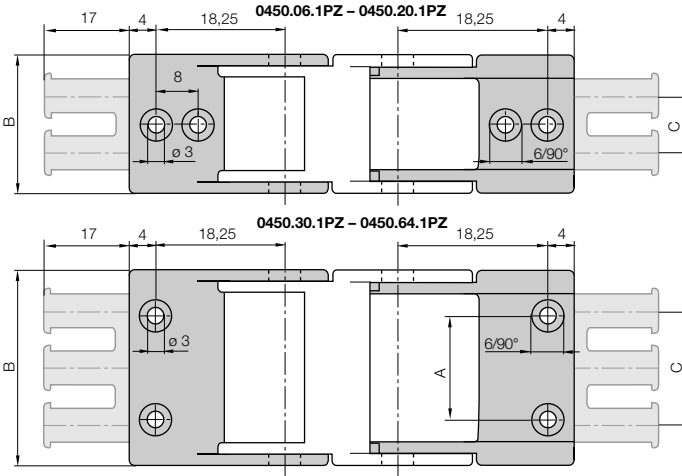

For E-Chain*	Part No. full set	Part No. full set zahl	Number of teeth	Dim. A [mm]	Dim. B [mm]	Dim. C [mm]
045.06. ▶	0450.06. 12 PZ	0450.06. 12	1	-	12	-
045.10. ▶	0450.10. 12 PZ	0450.10. 12	1	-	16	-
045.16. ▶	0450.16. 12 PZ	0450.16. 12	2	-	22	10
045.20. ▶	0450.20. 12 PZ	0450.20. 12	2	-	26	10
045.30. ▶	0450.30. 12 PZ	0450.30. 12	3	22	36	20
045.64. ▶	0450.64. 12 PZ	0450.64. 12	6	56	70	50

For the preassembled mode please add the index. 0450.20. 12 PZ A1

**Part No. structure**



- A... must be indicated on preassembled configurations
- With assembled strain relief tiewrap plates
- Full set = 12
- Width
- Mounting brackets for selected chain type

Full set, for both ends:

0450. 10. 12 | PZ | +tiewrap plate

Single-part order:

0450. 10. 1 | PZ | +tiewrap plate

Mounting bracket with bore

0450. 10. 2 | PZ | +tiewrap plate

Mounting bracket with pin

Phone +49- (0) 22 03-96 49-800  
Fax +49- (0) 22 03-96 49-222





● ● ● Price index



IPA Qualification Certificate:  
Cleanroom test  
upon request



Special equipment:  
Electrically conductive ESD/ATEX  
version upon request



UL94-V2 classifications  
upon request



iF-Design Award -  
for E2 micro-Series 05



Easy to assemble and to disassemble



When to use the Series 05:

- If light weight construction is required
- If minimal height and width dimensions are required
- If price is an issue



When not to use it:

- If snap-open links are required
  - ▶ Series 07 Zipper, page 4.10
- If quick insertion of cables with preassembled connectors is required
  - ▶ Series E06 Easy Chain®, page 3.20
- If extra rigidity is required
  - ▶ Series 06 E2 micro, page 5.26

- ① Very light weight -  
ideal for low inertia applications
- ② iF-Design Award
- ③ One-piece, non snap-open E-Chain®
- ④ Snap-open configuration
- ▶ Series 07 Zipper, page 4.10
- ▶ Series R07 Zipper Tube, page 4.28
- ⑤ Easy to fill configuration
- ▶ Series E06 Easy Chain®, page 3.20



Order example complete E-Chain®

Please indicate chain-lengths or number of links Example: 1 m or 50 links

1 m 05.20.038.0



E-Chain®

1 set 050.20.12



Mounting bracket

**Unsupported length**

$FL_G$  = with straight upper run

$FL_B$  = with permitted sag

Further information ► Design, page 1.12

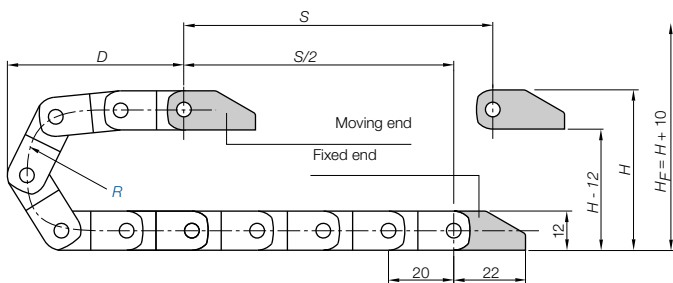
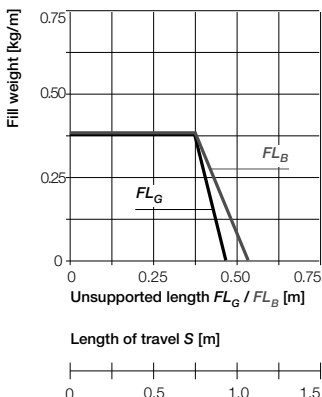
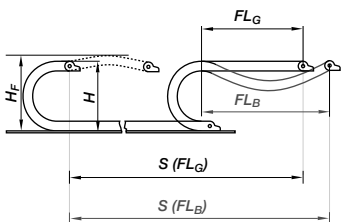

- $S$  = Length of travel
- $R$  = Bending radius
- $H$  = Nominal clearance height
- $H_F$  = Required clearance height
- $D$  = Overlength E-Chain® radius in final position
- $K = \pi \cdot R + \text{"safety"}$



**Short travels - unsupported**

Unsupported E-Chains® feature positive camber over short travels. This must be accounted for when specifying the clearance height  $H_F$ . Please consult igus® if space is particularly restricted.

Pitch = 20 mm/link    Links/m = 50 (1.000 mm)    Chain length =  $S/2 + K$

$R$	018	028	038
$H$	52	72	92
$D$	45	55	65
$K$	100	140	160

The required clearance height:  
 $H_F = H + 10$  mm  
 (with 0,2 kg/m fill weight)

10

E2 micro  
Inner height: 10 mm

Phone +49- (0) 22 03-96 49-800  
Fax +49- (0) 22 03-96 49-222



**Chainflex® CF98 - tested 30 million strokes with 4xd**

TPE outer jacket, oil- and bio-oil-resistant, PVC and halogen-free, low-temperature-flexible  
 Further information: [www.igus.de/en/CF98](http://www.igus.de/en/CF98)



Speed / acceleration $FL_G$	max. 20 [m/s] / max. 200 [m/s²]
Speed / acceleration $FL_B$	max. 3 [m/s] / max. 6 [m/s²]
Gliding speed / acceleration (maximum)	max. 3 [m/s] / max. 10 [m/s²]
Material - permitted temperature °C	igumid G / -40° up to +130° C
Flammability class, igumid G	VDE 0304 IIC UL94 HB

**Technical Data**



Details of material properties  
 ► page 1.38



► page 5.9

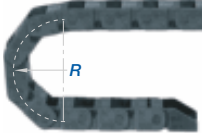
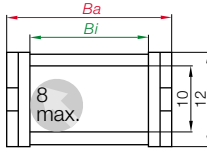

## Series 05 E-Chain® - non snap-open

Part No.	Bi [mm]	Ba [mm]	R [mm]	Bending radii	Weight [kg/m]
05.06.□.0	6	10	018	028 038	~ 0,06
05.10.□.0	10	14	018	028 038	~ 0,07
05.16.□.0	16	20	018	028 038	~ 0,07
05.20.□.0	20	24	018	028 038	~ 0,08
05.30.□.0	30	34	018	028 038	~ 0,09
05.64.□.0	64	68	018	028 038	~ 0,19

Supplement Part No. with required radius. Example: 05.20.038.0

0 = standard color, other colors ► page 1.39 · Pitch = 20 mm/link - Links/m = 50

## Part No. structure

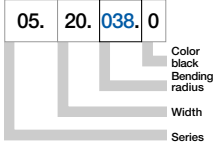



**Polymer, one-piece**

- One-piece mounting bracket
- Corrosion-resistant
- Available preassembled
- Inner and outer attachment possible

Moving end with bore  
(outer link) 050...1

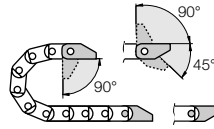

050...2 Fixed end  
with pin (inner link)

Possible installation conditions for assembled mounting brackets ▶ Order example "preassembled" below

050...1  
Moving end

050...2  
Fixed end

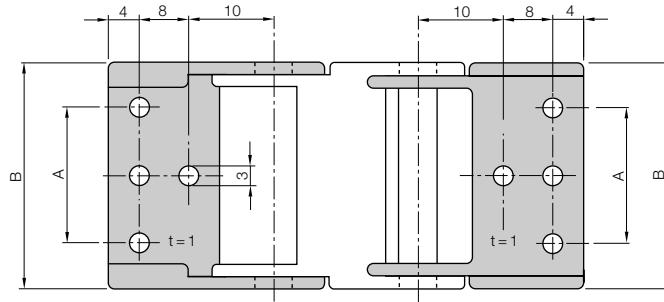

050.06.12 - 050.20.12: center bores only

050.30.12 - 050.64.12: outer bores only

For E-Chain*	Part No. full set	Dim. A [mm]	Dim. B [mm]
05.06. ▶	050.06. 12	-	10,7
05.10. ▶	050.10. 12	-	14,7
05.16. ▶	050.16. 12	-	20,7
05.20. ▶	050.20. 12	-	24,7
05.30. ▶	050.30. 12	22	34,7
05.64. ▶	050.64. 12	56	68,7

For the preassembled mode please add the index A1 ... A4 e.g. 050.20. 12 A1

**Dimensions and order configurations**

Part No. structure

050.	20.	12	A1
------	-----	----	----

A... must be indicated on preassembled configurations  
Full set = 12  
Width  
Mounting brackets for selected chain type

Full set, for both ends:

050. 20. 12

Single-part order:

050. 20. 1

Mounting bracket with bore

050. 20. 2

Mounting bracket with pin

Phone +49- (0) 22 03-96 49-800  
Fax +49- (0) 22 03-96 49-222



● ● ● Price index



IPA Qualification Certificate:  
Cleanroom test  
upon request



Special equipment:  
Electrically conductive ESD/ATEX  
version upon request



UL94-V2 classifications  
upon request



Easy to assemble and to disassemble



When to use the Series 06:

- High torsional rigidity
- If price is an issue
- If connection options are required  
(Quicksnap, Quickfix, ...)



When not to use it:

- If snap-open links are required  
▶ Series 07 Zipper, page 4.10
- If quick insertion of cables with  
preassembled connectors is required  
▶ Series E06 Easy Chain®, page 3.20
- If very quiet operation is required  
▶ Series 045 E2 micro, page 5.18

- ① High torsional rigidity
- ② Very light weight - low price
- ③ Dirt-repellent exterior
- ④ Mounting bracket with integrated strain relief
- ⑤ Easy to fill configuration
- ▶ Series E06 Easy Chain®, page 3.20
- ⑥ Snap-open configuration
- ▶ Series 07 Zipper, page 4.10
- ⑦ Molded-in separator available  
Series 06.16.018.S1

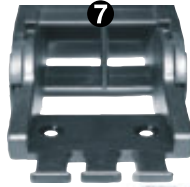

Order example complete E-Chain®

Please indicate chain-lengths or number of links Example: 1 m or 50 links

1 m 06.20.038.0



E-Chain®

1 set 060.20.12PZ



Mounting bracket

**Unsupported length**

$FL_G$  = with straight upper run

$FL_B$  = with permitted sag

Further information ► **Design, page 1.12**

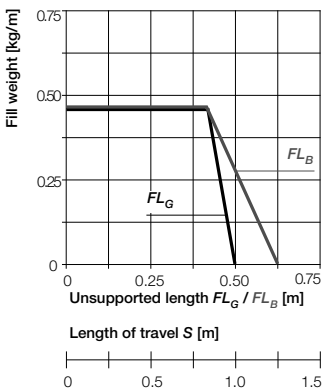
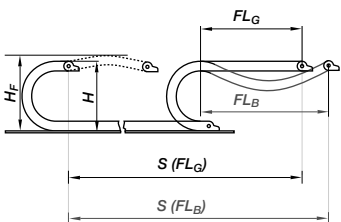

- $S$  = Length of travel
- $R$  = Bending radius
- $H$  = Nominal clearance height
- $H_F$  = Required clearance height
- $D$  = Overlength E-Chain® radius in final position
- $K = \pi \cdot R + \text{"safety"}$

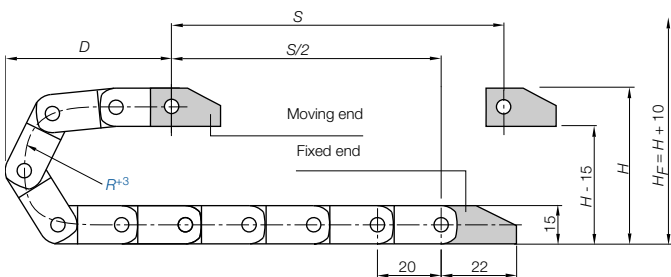

**Short travels - unsupported**

Unsupported E-Chains® feature positive camber over short travels. This must be accounted for when specifying the clearance height  $H_F$ . Please consult igus® if space is particularly restricted.

**Pitch = 20 mm/link   Links/m = 50 (1.000 mm)   Chain length =  $S/2 + K$**

	018	028	038
$R$			
$H$	52	72	92
$D$	45	55	65
$K$	100	140	160

The required clearance height:  
 $H_F = H + 10$  mm  
 (with 0,2 kg/m fill weight)

10,5

E2 micro  
Inner height: 10,5 mm

Phone +49- (0) 22 03-96 49-800  
Fax +49- (0) 22 03-96 49-222



**Molded-in separator - Line-extension**

Part No. 06.16.018.S1 -

Separated into 2 compartments: 8,5 mm, 6,3 mm, Bending radius 18 mm.  
Safe cable separation in small dimensions

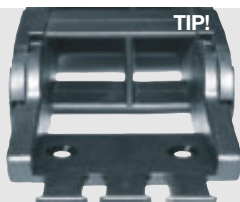

Speed / acceleration $FL_G$	max. 20 [m/s] / max. 200 [m/s <sup>2</sup> ]
Speed / acceleration $FL_B$	max. 3 [m/s] / max. 6 [m/s <sup>2</sup> ]
Gliding speed / acceleration (maximum)	max. 3 [m/s] / max. 10 [m/s <sup>2</sup> ]
Material - permitted temperature °C	igumid G / -40° up to +130° C
Flammability class, igumid G	VDE 0304 IIC UL94 HB

**Technical Data**



Details of material properties  
► page 1.38



► page 5.9



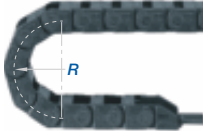
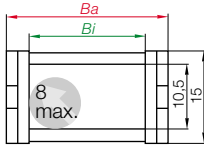

## Series 06 E-Chain® - non snap-open

Part No.	$Bj$ [mm]	$Ba$ [mm]	$R$ [mm]	Bending radii	Weight [kg/m]
06.06.□.0	6	12,5	018	028 038	≈ 0,13
06.10.□.0	10	16,5	018	028 038	≈ 0,14
06.16.□.0	16	22,5	018	028 038	≈ 0,16
06.20.□.0	20	27,0	018	028 038	≈ 0,17
06.30.□.0	30	37,0	018	028 038	≈ 0,20
06.40.□.0	40	47,0	018	028 038	≈ 0,23
06.50.□.0	50	57,0	018	028 038	≈ 0,26
06.64.□.0	64	71,0	018	028 038	≈ 0,30

Supplement Part No. with required radius. Example: 06.20.038.0

0 = standard color, other colors ► page 1.39 · Pitch = 20 mm/link - Links/m = 50

## Part No. structure

06.	20.	038.	0
-----	-----	------	---





**Polymer, one-piece**

- One-piece mounting bracket
- Corrosion-resistant
- Available preassembled
- Inner and outer attachment possible
- Available with or without strain relief tiwrap plates

Moving end with bore  
(outer link) 060...1(PZ)

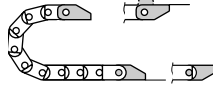

060...2(PZ) Fixed end  
with pin (inner link)



Possible installation conditions for assembled mounting brackets ▶ Order example "preassembled" below

060...1(PZ)  
Moving end

060...2(PZ)  
Fixed end

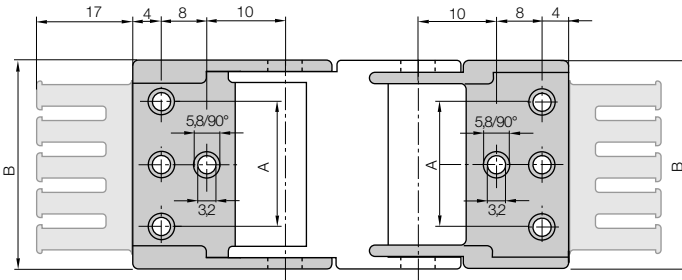

060.06.12 - 060.20.12: center bores only

060.30.12 - 060.64.12: outer bores only

For E-Chain®	Part No. full set with tiwrap plate	Part No. full set without tiwrap plate	Number of teeth	Dim. A [mm]	Dim. B [mm]
06.06. ▶	060.06. 12 PZ	060.06. 12	1	–	12,5
06.10. ▶	060.10. 12 PZ	060.10. 12	1	–	16,5
06.16. ▶	060.16. 12 PZ	060.16. 12	2	–	22,5
06.20. ▶	060.20. 12 PZ	060.20. 12	2	–	27,0
06.30. ▶	060.30. 12 PZ	060.30. 12	3	22	37,0
06.40. ▶	060.40. 12 PZ	060.40. 12	4	32	47,0
06.50. ▶	060.50. 12 PZ	060.50. 12	5	42	57,0
06.64. ▶	060.64. 12 PZ	060.64. 12	6	56	71,0

For the preassembled mode please add the index A1 ... A4 e.g. 060.20. 12 PZ A1

**Dimensions and order configurations**

Strain relief is possible on the moving end and/or the fixed end.

**Part No. structure**

060.20. 12 PZ A1

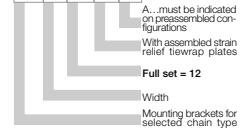

**Full set, for both ends:**

060.20. 12 PZ +tiwrap plate

**Single-part order:**

060.20. 1 PZ +tiwrap plate

Mounting bracket with bore

060.20. 2 PZ +tiwrap plate

Mounting bracket with pin

Phone +49- (0) 22 03-96 49-800  
Fax +49- (0) 22 03-96 49-222



**Quicksnap** - the complete, detachable mounting unit, upon request

Part No. 060.10.QS, Art. Nr. 060.16.QS,

Part No. 060.20.QS, Art. Nr. 060.40.QS



**Quickfix** - mounting bracket with dowel, upon request

**Additional Features**



▶ page 5.9

● ● ● Price index



IPA Qualification Certificate:  
Cleanroom test  
upon request



Special equipment:  
Electrically conductive ESD/ATEX  
version upon request



UL94-V2 classifications  
upon request



Easy to assemble and to disassemble



When to use the Series 08:

- If quiet operation is required
- If price is an issue
- If connection options are required  
(Quicksnap, Quickfix, ...)
- If high torsional rigidity is required



When not to use it:

- If snap-open links are required  
▶ Series 09 Zipper, page 4.14
- If quick insertion of cables with  
preassembled connectors is required  
▶ Series E08 Easy Chain®, page 3.28

- ① Small pitch for very quiet operation
- ② High torsional rigidity
- ③ Very light weight - low price
- ④ Dirt-repellent exterior
- ⑤ Mounting brackets with strain relief options
- ⑥ One piece each link
- ⑦ Easy to fill configuration
- ▶ Series E08 Easy Chain®, page 3.28
- ⑧ Snap-open configuration
- ▶ Series 09 Zipper, page 4.14
- ⑨ Fully enclosed E-Tube
- ▶ Series R09 Zipper Tube, page 4.32



Order example complete E-Chain®

Please indicate chain-lengths or number of links Example: 1 m or 50 links

1 m 08.30.038.0



E-Chain®

1 set 080.30.12PZ



Mounting bracket

**Unsupported length**

$FL_G$  = with straight upper run

$FL_B$  = with permitted sag

Further information ► **Design, page 1.12**

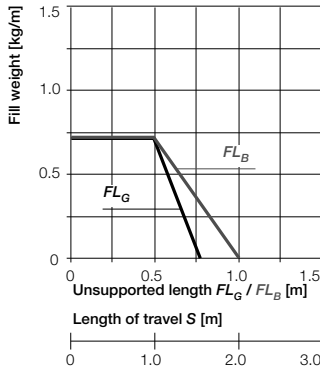
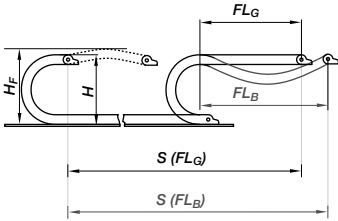

- $S$  = Length of travel
- $R$  = Bending radius
- $H$  = Nominal clearance height
- $H_F$  = Required clearance height
- $D$  = Overlength E-Chain\* radius in final position
- $K = \pi \cdot R + \text{"safety"}$

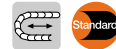
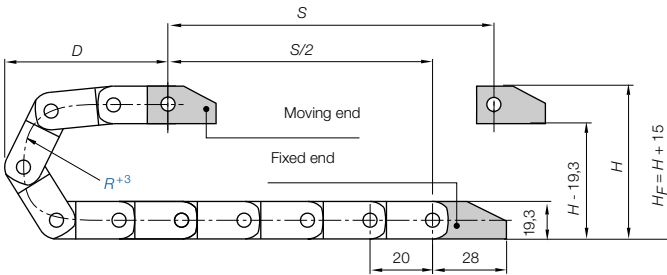

**Short travels - unsupported**

Unsupported E-Chains\* feature positive camber over short travels. This must be accounted for when specifying the clearance height  $H_F$ . Please consult igus\* if space is particularly restricted.

**Pitch = 20 mm/link    Links/m = 50 (1.000 mm)    Chain length =  $S/2 + K$**

R	025*	028	038	048
H	70	76	96	116
D	57	60	70	80
K	120	130	160	190

\*Radius 025 only for Part No. 08.10

The required clearance height:  
 $H_F = H + 15 \text{ mm}$   
 (with 0,3 kg/m fill weight)



E2 micro  
 Inner height: 15 mm

Phone +49- (0) 22 03-96 49-800  
 Fax +49- (0) 22 03-96 49-222



Speed / acceleration $FL_G$	max. 20 [m/s] / max. 200 [m/s <sup>2</sup> ]
Speed / acceleration $FL_B$	max. 3 [m/s] / max. 6 [m/s <sup>2</sup> ]
Gliding speed / acceleration (maximum)	max. 3 [m/s] / max. 10 [m/s <sup>2</sup> ]
Material - permitted temperature °C	igumid G / -40° up to +130° C
Flammability class, igumid G	VDE 0304 IIC UL94 HB

**Technical Data**



Details of material properties  
 ► page 1.38



► page 5.9

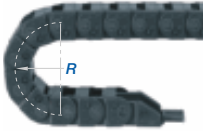
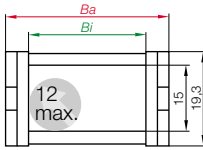

Part No. structure

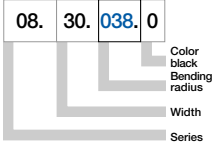

## Series 08 E-Chain® - non snap-open

Part No.	Bl [mm]	Ba [mm]	R [mm]	Bending radii	Weight [kg/m]
08.10.□.0	10	18,2	025 028 038 048		≈ 0,21
08.13.□.0	13	21,2	028 038		≈ 0,23
08.16.□.0	16	24,2	028 038 048		≈ 0,24
08.20.□.0	20	28,2	028 038 048		≈ 0,25
08.30.□.0	30	38,2	028 038 048		≈ 0,28
08.40.□.0	40	48,2	028 038 048		≈ 0,31
08.50.□.0	50	58,2	028 038 048		≈ 0,37

Supplement Part No. with required radius. Example: 08.30.038.0

0 = standard color, other colors ► page 1.39 · Pitch = 20 mm/link - Links/m = 50





**Polymer, one-piece**

- One-piece mounting bracket
- Corrosion-resistant
- Available preassembled
- Inner and outer attachment possible
- Available with or without strain relief tiwrap plates

Moving end with bore  
(outer link) 080...1 (PZ)

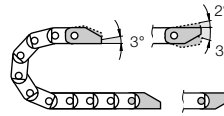

080...2 (PZ) Fixed end  
with pin (inner link)

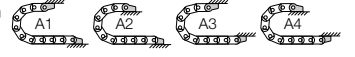

Possible installation conditions for assembled mounting brackets ▶ Order example "preassembled" below

080...1 (PZ)  
Moving end

080...2 (PZ)  
Fixed end

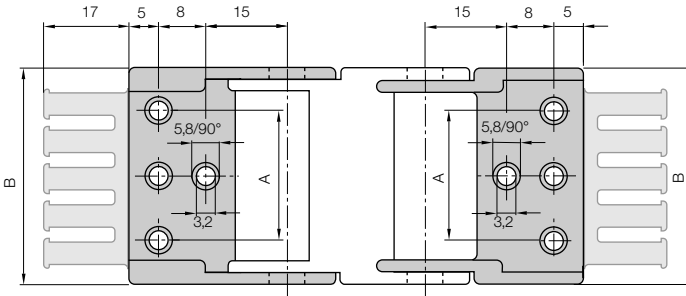

080.06.12 - 080.20.12: center bores only  
080.30.12 - 080.50.12: all bores

For E-Chain®	Part No. full set with tiwrap plate	Part No. full set without tiwrap plate	Number of teeth	Dim. A [mm]	Dim. B [mm]
08.10. ▶	080.10. 12 PZ	080.10. 12	1	–	18,2
08.13. ▶	080.13. 12 PZ	080.13. 12	2	–	21,2
08.16. ▶	080.16. 12 PZ	080.16. 12	2	–	24,2
08.20. ▶	080.20. 12 PZ	080.20. 12	2	–	28,2
08.30. ▶	080.30. 12 PZ	080.30. 12	3	22	38,2
08.40. ▶	080.40. 12 PZ	080.40. 12	4	32	48,2
08.50. ▶	080.50. 12 PZ	080.50. 12	5	42	58,2

For the preassembled mode please add the index A1 ... A4 e.g. 080.30. 12 PZ A1

**Dimensions and order configurations**

Strain relief is possible on the moving end and/or the fixed end.

**Part No. structure**

080.30. 12 PZ A1

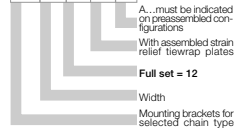

**Full set, for both ends:**

080.30. 12 PZ +tiwrap plate

**Single-part order:**

080.30. 1 PZ +tiwrap plate

Mounting bracket with bore

080.30. 2 PZ +tiwrap plate

Mounting bracket with pin

Phone +49- (0) 22 03-96 49-800  
Fax +49- (0) 22 03-96 49-222



▶ page 5.9



**Quicksnap** - the complete, detachable mounting unit, upon request

Part No. 080.20.QS, Part No.080.30.QS



**Quickfix** - mounting bracket with dowel, upon request

**Additional Features**



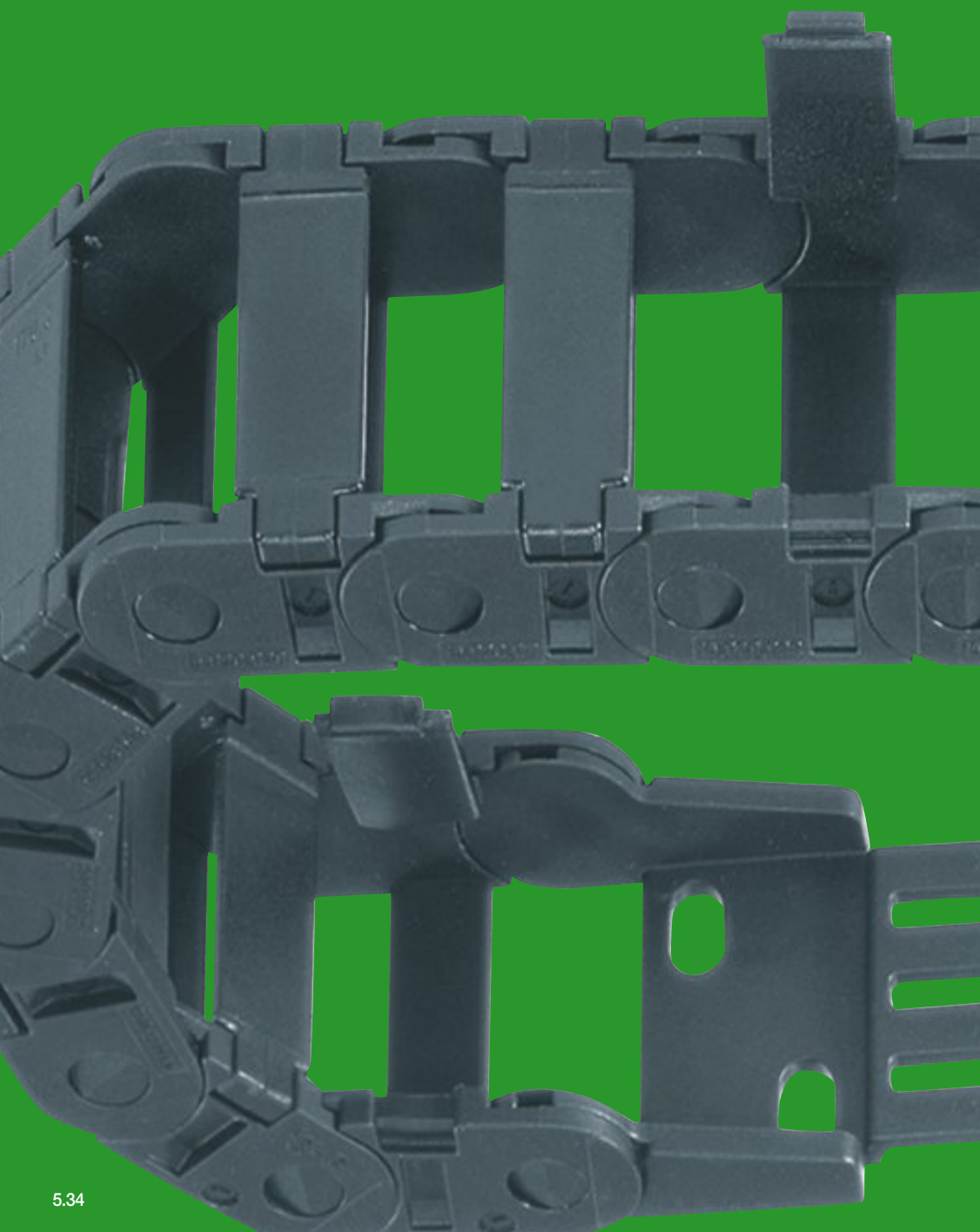

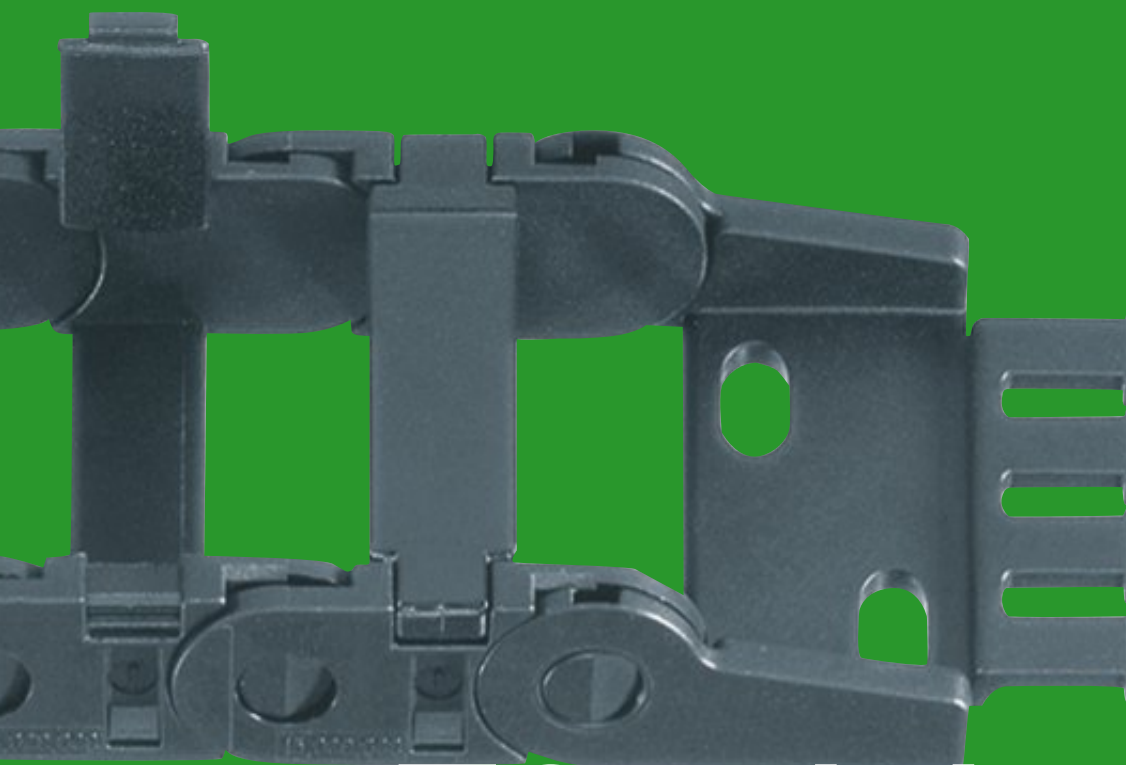

# E2 mini

Large pins    Double stop dog    Cable-friendly, smooth interior    Material igumid G -40/+130°C

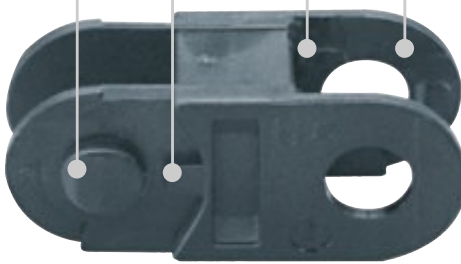

### E2 mini one- and two-piece E-Chains\* - small and medium sizes

- Small pitch for smooth running
- Double stop dog for long service life
- Optimized relation: weight - stability
- Large pins for long unsupported lengths
- Easy to assemble
- Various interior separation
- You can find more technical data about the material, chemical resistance, temperatures ► **chapter design, from page 1.38**

#### Opening-principle

- 10**    Snap-open links are not necessary
- 14**    Snap-open along inner radius
- B15i**    Snap-open along inner radius
- F17**
- B15**    Snap-open along outer radius
- B17**

#### Dimensioning

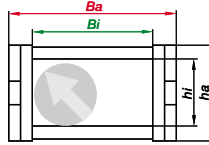

#### Bending radius

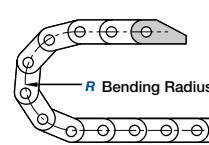

#### Part No. structure

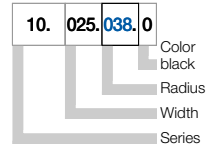

#### Selection table

Series	Inner height <i>hi</i> [mm]	Inner width <i>Bi</i> [mm]	Outer width <i>Ba</i> [mm]	Outer height <i>ha</i> [mm]	Bending radius <i>R</i> [mm]	Unsupported length max. [m]	Page
<b>10</b>	18	15 - 100	26 - 113	23	28 - 180	1,30	<b>5.40</b>
<b>11.031</b>	23	31	41,2	28	45 - 70	1,50	<b>5.46</b>
<b>11.080</b>	28	80	93	33,4	38	1,50	<b>5.50</b>
<b>11.1 / 11.2</b>	41	15 - 25	25,5 - 35,5	46	40 - 100	1,50	<b>5.54</b>
<b>14</b>	20	15 - 50	26 - 61	25	28 - 125	0,65	<b>5.58</b>
<b>B15i / B15</b>	17	15 - 100	26 - 113	23	38 - 180	1,30	<b>5.62</b>
<b>B17</b>	32	15 - 100	25,5 - 113	39	48 - 125	1,00	<b>5.68</b>
<b>F17</b>	32	15 - 100	26 - 113	39	48 - 125	1,20	<b>5.74</b>

# For shorter assembly time...

**Reduce time up to 80%**

Product A

EasyChain® Series 200

**Easy Chain®** - Just push the cables with your thumb into the E-Chain® - and it's ready ► **chapter 3**

**Reduce time up to 60%**

Product A

Zipper Series R17

**Zipper** - Reduced assembly-time - Zipper-like design for quick opening and closing of lids ► **chapter 4**

Main characteristics at a first glance

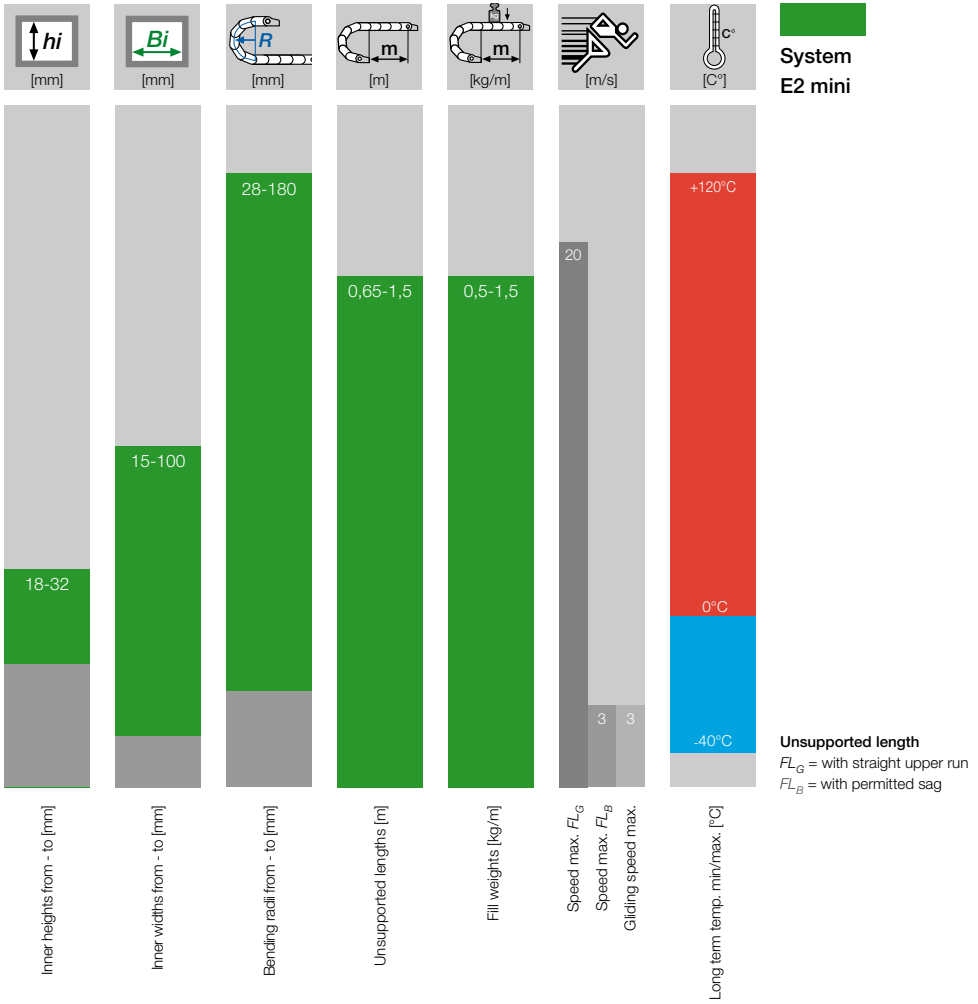

Additional quality features - E2 mini

**Clean-Room** Cleanroom Class 1 (ISO class 3) for Series 10 and 14, tested by the Dryden Engineering Company, California



Special equipment: Electrically conductive ESD/ATEX version upon request - for Series 10

**RU** UL94 - V2 classifications - Series 14

► Next page: Find application examples and assembly instructions

E2 mini are small one-piece or two-piece E-Chains® ideal for high dynamic applications. igus® also offers a host of accessories and fixation options. "Upgrades" to openable versions are available for many types in these cases they are interchangeable and can also serve as replacement.

**Typical industries and applications**

- General machinery
- Models (micro E-Chains®)
- Construction machinery
- Vehicles
- Furniture
- Electric cabinets
- General machinery - slow movements
- Electric equipment
- Vending machines

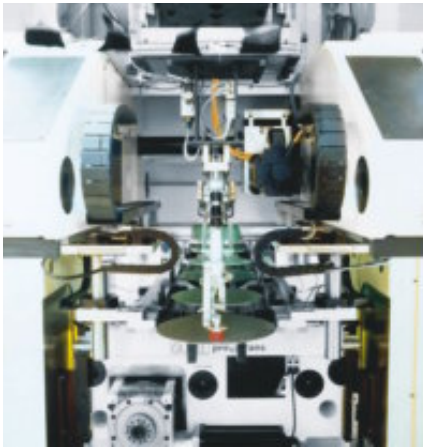

Short travels and high accelerations with Series 14/E2 mini in a handling machine



Openable E-Chains® with high stability igus® E2 mini - Series B15



E2 mini in a milling machine with hot chips and chemicals - UL94-V2 version



Long-travel applications up to 40 m are possible - here in textile machine

**Assembling | E2 mini**



1 Push and click



2 Snap in pin

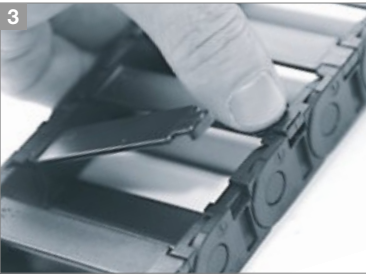

3 Push and snap

**Separation | E2 mini**

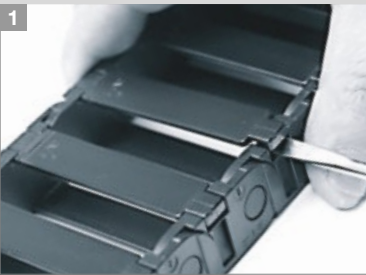

1 Lever crossbars open



2 Swivel crossbars



3 Release side-link



4 Twist and pull apart



## E2 mini | Series 10

● ● ● Price index



Cleanroom Class 1 (ISO class 3)  
for Series 10, tested by the Dryden  
Engineering Company, California



Special equipment:  
Electrically conductive ESD/ATEX  
version upon request



Easy to assemble and to disassemble



When to use the Series 10:

- If opening is not necessary
- If many connection options are required (Quicksnap, Quickfix,...)
- If a small but very stable chain is required



When not to use it:

- If extremely quick opening of the links is necessary
  - ▶ Series 15 Zipper, page 4.18
- If quick insertion of cables with preassembled connectors is required
  - ▶ Series E14 Easy Chain®, page 3.22

- 1 Large pins and double stop dog for superior life and long unsupported length
- 2 Mounting bracket with integrated strain relief
- 3 Dirt-repellent exterior
- 4 Interior separation available
- 5 One piece each link
- 6 Easy to fill configuration
- ▶ Series E14 Easy Chain®, page 3.32
- 7 Snap-open configuration
- ▶ Series 15 Zipper page, 4.18
- ▶ Series R15 Zipper Tube, page 4.36
- 8 Molded-in separator available  
Series 10.050.075.S



Order example complete E-Chain®

Please indicate chain-lengths or number of links Example: 1 m or 33 links

1 m 10.025.038.0



E-Chain®

with 2 separators 111 assembled every 2<sup>nd</sup> link



Interior separation

1 set 1025.12PZ



Mounting bracket



**Unsupported length**

$FL_G$  = with straight upper run

$FL_B$  = with permitted sag

Further information ► **Design, page 1.12**

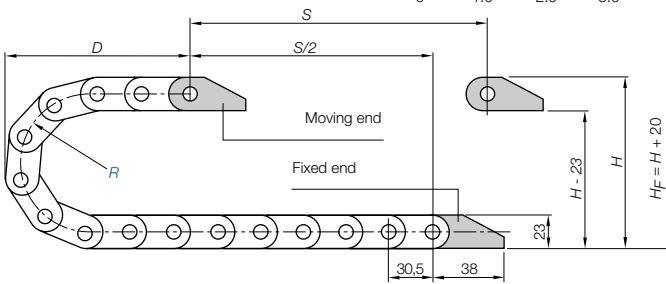
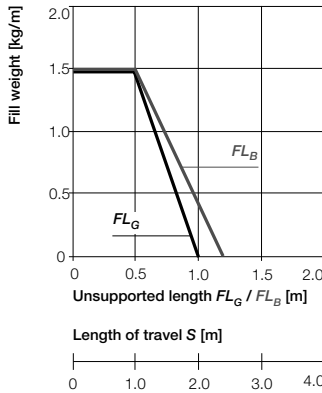
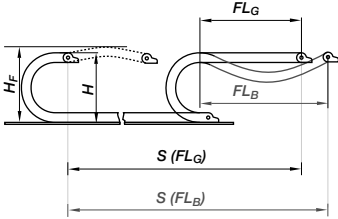

- $S$  = Length of travel
- $R$  = Bending radius
- $H$  = Nominal clearance height
- $H_f$  = Required clearance height
- $D$  = Overlength E-Chain\* radius in final position
- $K = \pi \cdot R + \text{"safety"}$

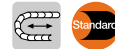

**Short travels - unsupported**

Unsupported E-Chains\* feature positive camber over short travels. This must be accounted for when specifying the clearance height  $H_f$ . Please consult igus\* if space is particularly restricted.

**Pitch = 30,5 mm/link Links/m = 33 (1.006,5 mm) Chain length =  $S/2 + K$**

R	028	038	048	075	100	110	125	145	180
H	80	100	120	175	225	245	275	315	385
D	70	80	90	120	145	155	170	190	225
K	150	185	215	300	375	410	455	520	630

The required clearance height:  
 $H_f = H + 20$  mm  
 (with 1,5 kg/m fill weight)

Speed / acceleration $FL_G$	max. 20 [m/s] / max. 200 [m/s <sup>2</sup> ]
Speed / acceleration $FL_B$	max. 3 [m/s] / max. 6 [m/s <sup>2</sup> ]
Gliding speed / acceleration (maximum)	max. 3 [m/s] / max. 10 [m/s <sup>2</sup> ]
Material - permitted temperature °C	igumid G / -40° up to +130° C
Flammability class, igumid G	VDE 0304 IIC UL94 HB

**Technical Data**



Details of material properties  
 ► page 1.38



E2 mini  
 Inner height: 18 mm

Phone +49- (0) 22 03-96 49-800  
 Fax +49- (0) 22 03-96 49-222



► page 5.39

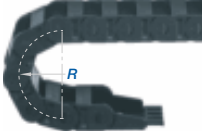
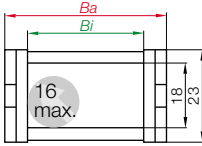

Series 10 E-Chain® - non snap-open

Part No.	Bi [mm]	Ba [mm]	R [mm]	Bending radii										Weight [kg/m]
10.015.	.0	15	26	028	038	048	075	100	110	125	145	180	~ 0,35	
10.025.	.0	25	36	028	038	048	075	100	110	125	145	180	~ 0,40	
10.038.	.0	38	49	028	038	048	075	100	110	125	145	180	~ 0,46	
10.050.	.0	50	61	028	038	048	075	100	110	125	145	180	~ 0,52	
10.5.	.0	63	76	028	038	048	075	100	110	125	145	180	~ 0,63	
10.6.	.0	80	94	028	038	048	075	100	110	125	145	180	~ 0,70	
10.7.	.0	100	113	028	038	048	075	100	110	125	145	180	~ 0,76	

Supplement Part No. with required radius. Example: 10.025. 038.0

0 = standard color, other colors ▶ page 1.39 - Pitch = 30,5 mm/link - Links/m = 33

Part No. structure

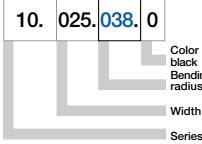

E2 mini | Series 10 | Accessories | Interior Separation

Vertical Separator	
unassembled	101
assembled	111



Option 1: Vertical Separators

Vertical Separators are used if a vertical subdivision of the E-Chain® interior is required - By standard Vertical Separators are assembled every other E-Chain® link

- Standard subdivision with Vertical Separator 111

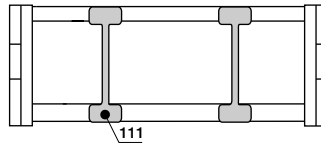

Molded-in separator - Line-extension

Part No. 010.050.075 -

Inner/outer width 50/61 mm, radius 75 mm, more sizes upon request  
Separation: Middle compartment 21 mm, 2 side compartments 13 mm

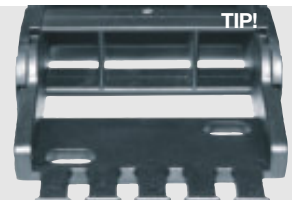

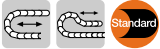

### The Standard - option polymer - pivoting

- Recommended for unsupported and gliding applications
- Well suited for tight installation conditions
- Strain relief with detachable tiwrap plates
- Variable traverse angle for flexible assembly
- The twistability of the E-Chain® and the option to assemble the mounting brackets on the fixed end and/or the moving end, enable various installation options

Moving end with bore (outer link) 10...3P(Z)

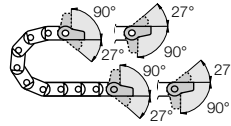

10...4P(Z) Fixed end with pin (inner link)

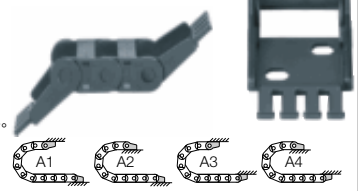

Possible installation conditions for assembled mounting brackets ▶ Order example "preassembled" below

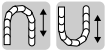

### Option polymer - locking

- Recommended for unsupported and gliding applications
- Furthermore:
- At very high speed and/or acceleration
  - If space is limited for height (the  $H_F$  measurement)
  - The twistability of the E-Chain® and the option to assemble the mounting brackets on the fixed end and/or the moving end, enable various installation options

Moving end with bore (outer link) 10...1P(Z)

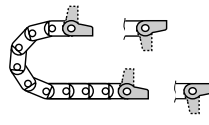

10...2P(Z) Fixed end with pin (inner link)

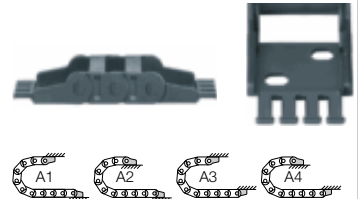

Possible installation conditions for assembled mounting brackets ▶ Order example "preassembled" below

10...3P(Z) Standard! (pivoting)  
10...1P(Z) (locking)

Moving end

For E-Chain®:  
10.015. to 10.050

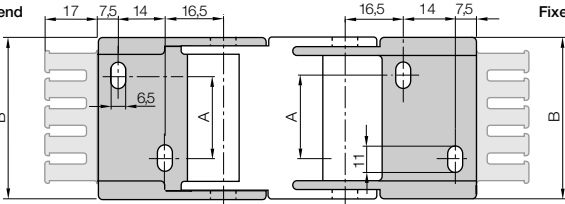

For E-Chain®:  
10.5. to 10.7

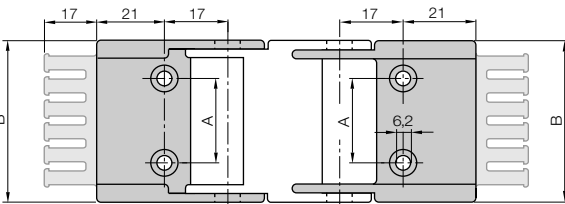

For E-Chain®	Part No. full set with tiwrap plate	Part No. full set without tiwrap plate	Dim. A [mm]	Dim. B [mm]
10.015. ▶	1015. <input type="checkbox"/> PZ	1015. <input type="checkbox"/> P	-	25,5
10.025. ▶	1025. <input type="checkbox"/> PZ	1025. <input type="checkbox"/> P	10	35,5
10.038. ▶	1038. <input type="checkbox"/> PZ	1038. <input type="checkbox"/> P	23	48,5
10.050. ▶	1050. <input type="checkbox"/> PZ	1050. <input type="checkbox"/> P	35	60,5
10.5. ▶	105. <input type="checkbox"/> PZ	105. <input type="checkbox"/> P	48	75,0
10.6. ▶	106. <input type="checkbox"/> PZ	106. <input type="checkbox"/> P	65	92,0
10.7. ▶	107. <input type="checkbox"/> PZ	107. <input type="checkbox"/> P	85	112,0

Please add the Part No. with the requested index - 34 for the pivoting configuration e.g. 1025.  34 PZ or 12 for the locking configuration e.g. 1025.  12 PZ

For the preassembled mode please add the index  A1 ...  A4 e.g. 1025.  34 PZ  A1

Standard! (pivoting) 10...4P(Z) (locking) 10...2P(Z)

Fixed end

### Dimensions and order configurations

Strain relief is possible on the moving end and/or the fixed end.

#### Part No. structure (pivoting)



#### Full set, for both ends:

1025.  34 PZ +tiwrap plate

#### Single-part order:

1025.  3 PZ +tiwrap plate

Mounting bracket with bore

1025.  4 PZ +tiwrap plate

Mounting bracket with pin

#### Part No. structure (locking)

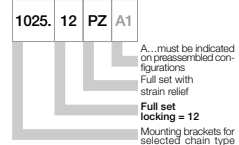

#### Full set, for both ends:

1025.  12 PZ +tiwrap plate

#### Single-part order:

1025.  1 PZ +tiwrap plate

Mounting bracket with bore

1025.  2 PZ +tiwrap plate

Mounting bracket with pin

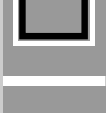

- Ba = Outer width E-Chains® / E-Tube
- Bi = Inner width E-Chains® / E-Tube
- ha = Outer height E-Chains® / E-Tube
- H<sub>Ri</sub> = Inner trough height
- H<sub>Ra</sub> = Outer trough height
- B<sub>Ri</sub> = Inner trough width ► depends on dim. Ba
- B<sub>Ra</sub> = Outer trough width
- n<sub>Mon</sub> = Number of installation sets (left/right)
- n<sub>Ri</sub> = Number of troughs sets (left/right)
- $H_{Ri} \geq 2 \cdot ha$   
 $B_{Ri} \geq Ba + 4$
- = Guide trough set     ● = Glide bar  
● = Installation set "Basic"     ● = C-profile

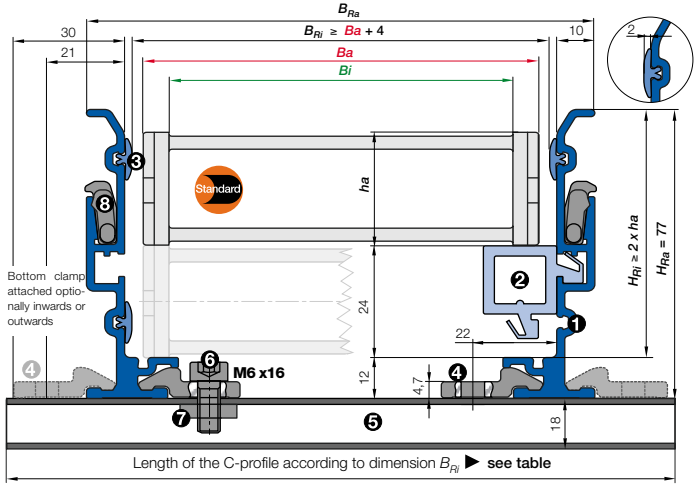

Phone +49- (0) 22 03-96 49-800  
Fax +49- (0) 22 03-96 49-222

**Installation set "Basic" with C-profile**

Bottom Clamp attached optionally inwards or outwards

10.5.038.0 ► Order example

	Part No.	Part No.	
		B <sub>Ri</sub> attached inwards [mm]	attached outwards
.015	30	-	960.30.125
.025	40	-	960.30.150
.038	53	-	960.30.150
.050	65	960.30.125	960.30.175
.5	80	960.30.125	960.30.175
.6	98	960.30.150	960.30.200
.7	117	960.30.175	960.30.225



- Components, trough "Basic": ① Trough side parts, aluminum, 2 m ② Glide bar, plastic, 2 m ③ Glide strips, plastic, 2 m (without glide strips on request)
- Components, installation set "Basic": ④ Bottom clamp, aluminum ⑤ C-profile, steel galvanized ⑥ Screw M6 x16 ⑦ Sliding nut M6 ⑧ Interface connector, plastic

igus® GmbH  
51147 Cologne

**Order example: Length of travel 30 m - Center mounted for Series 10.5.038.0 with B<sub>Ri</sub> = 53**

- Guide trough set (set of 2 trough side parts, incl. glide strips) **without** glide bar  
Order text: 16 m guide trough without glide bar (8 x 2 m sections) **Part No. 970.30.SL**
- Guide trough set (set of 2 trough side parts, incl. glide strips) **with** glide bar  
Order text: 16 m guide trough with glide bar (8 x 2 m sections) **Part No. 970.31.SL**
- Installation set "Basic" complete (guide trough-sets + 1)  
Order text: 17 installation sets "Basic" **Part No. 960.30.150**

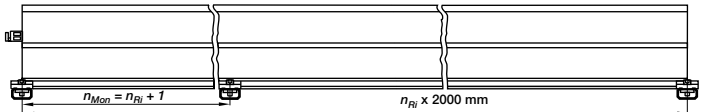

Principle sketch: Number of installation sets to be installed = **Number of trough sections + 1**

**Other guide trough systems**



"Single-piece steel guide troughs" with trough glide surface ► chapter 9



"Snap in trough" easy and fast assembly, favorable price due to simple structure, narrow design ► chapter 9

Internet: www.igus.de  
E-mail: info@igus.de

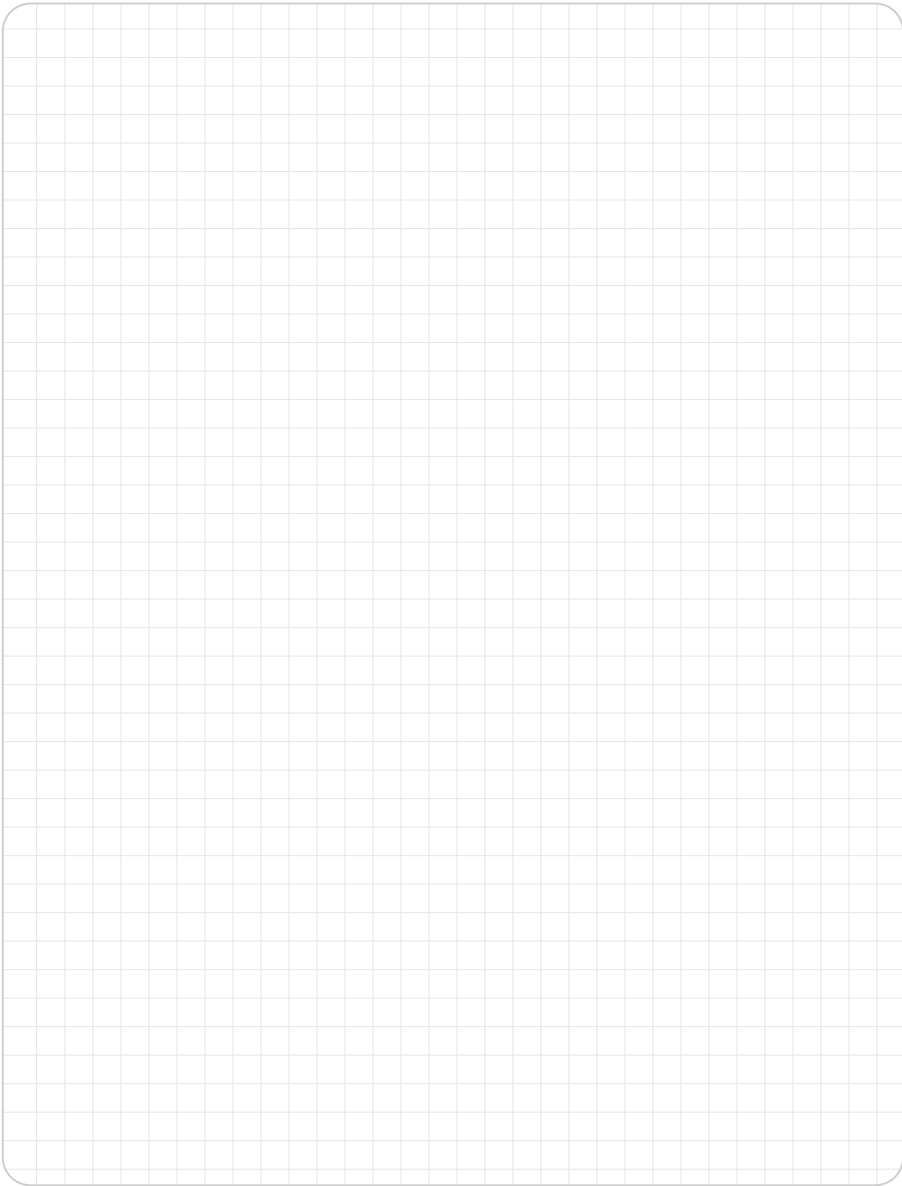

## Low cost PVC control cable for medium load requirements - Chainflex® CF130.UL

UL, flame-retardant

Further information: [www.igus.de/en/CF130UL](http://www.igus.de/en/CF130UL)

TIP!

IGUS® CHAINFLEX® CF130.UL



E2 mini  
Inner height: 18 mm

Phone +49- (0) 22 03-96 49-800  
Fax +49- (0) 22 03-96 49-222



▶ chapter 9



▶ page 5.39



Price index

UL94-V2 classifications  
upon request

- ① Torsional stability
- ② Mounting bracket with strain relief
- ③ Dirt-repellent exterior
- ④ One piece each link



Easy to assemble and to disassemble



When to use the Series 11.031:

- If space is restricted
- If many cables are arranged vertically adjacent



When not to use it:

- If snap-open links are required
  - ▶ similar width/height  
from Series Zipper, chapter 4
- If quick insertion of cables with preassembled connectors is required
  - ▶ similar width/height  
from Series Easy Chain®, chapter 3



Order example complete E-Chain®

Please indicate chain-lengths or number of links Example: 1 m or 33 links

1 m 11.031.070.0



E-Chain®

1 set 11.031.12PZ



Mounting bracket

**Unsupported length**

$FL_G$  = with straight upper run

$FL_B$  = with permitted sag

Further information ► **Design, page 1.12**

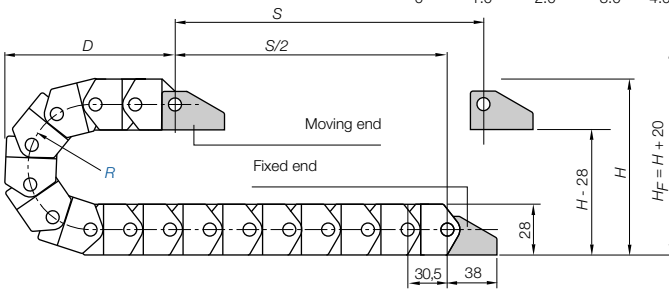
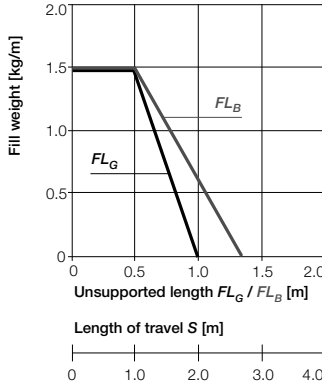
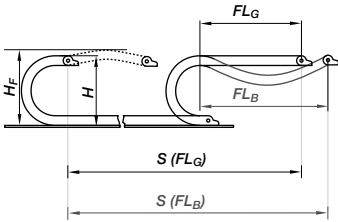

- $S$  = Length of travel
- $R$  = Bending radius
- $H$  = Nominal clearance height
- $H_F$  = Required clearance height
- $D$  = Overlength E-Chain® radius in final position
- $K$  =  $\pi \cdot R$  + "safety"

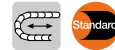

**Short travels - unsupported**

Unsupported E-Chains® feature positive camber over short travels. This must be accounted for when specifying the clearance height  $H_F$ . Please consult igus® if space is particularly restricted.

**Pitch = 30,5 mm/link Links/m = 33 (1.006,5 mm) Chain length =  $S/2 + K$**

$R$	045	070
$H$	115	165
$D$	90	115
$K$	205	285

The required clearance height:  
 $H_F = H + 20$  mm  
 (with 0,5 kg/m fill weight)



E2 mini  
Inner height: 23 mm

Phone +49- (0) 22 03-96 49-800  
Fax +49- (0) 22 03-96 49-222



Speed / acceleration $FL_G$	max. 20 [m/s] / max. 200 [m/s <sup>2</sup> ]
Speed / acceleration $FL_B$	max. 3 [m/s] / max. 6 [m/s <sup>2</sup> ]
Gliding speed / acceleration (maximum)	max. 3 [m/s] / max. 10 [m/s <sup>2</sup> ]
Material - permitted temperature °C	igumid G / -40° up to +130° C
Flammability class, igumid G	VDE 0304 IIC UL94 HB

**Technical Data**



Details of material properties  
► page 1.38



► page 5.39



igus® E-ChainSystems®

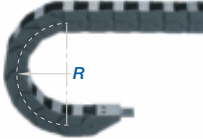
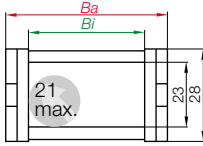

Series 11.031 E-Chain® - non snap-open

Part No.	Bi [mm]	Ba [mm]	R [mm]	Bending radii	Weight [kg/m]
11.031.□.0	31	41,2	045	070	~ 0,43

Supplement Part No. with required radius. Example: 11.031.070.0  
 0 = standard color, other colors ▶ page 1.39 · Pitch = 30,5 mm/link - Links/m = 33

Phone +49- (0) 22 03-96 49-800  
 Fax +49- (0) 22 03-96 49-222

Part No. structure

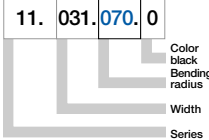

igus® GmbH  
 51147 Cologne

Internet: www.igus.de  
 E-mail: info@igus.de



**Polymer, one-piece**

- One-piece mounting bracket
- Corrosion-resistant
- Available preassembled
- Inner and outer attachment possible
- Available with or without strain relief tiewrap plates

Moving end with bore  
(outer link) 11...1P(Z)

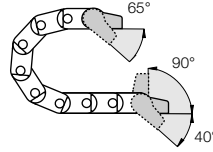

11...2P(Z) Fixed end  
with pin (inner link)

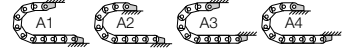
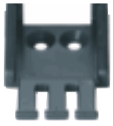

Possible installation conditions for assembled mounting brackets ► Order example "preassembled" below

11...1P(Z)  
Moving end

11...2P(Z)  
Fixed end

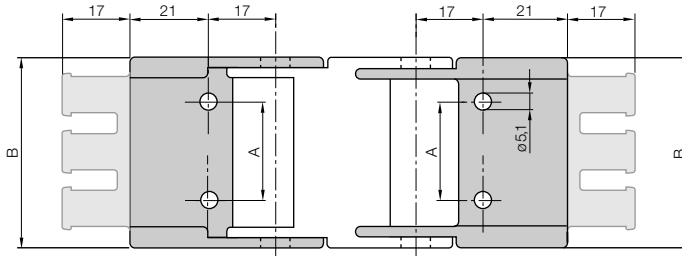

**Dimensions and order configurations**

Strain relief is possible on the moving end and/or the fixed end.

**Part No. structure**

11.031.12.PZ.A1

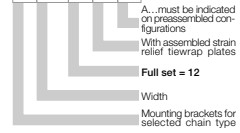

**Full set, for both ends:**

11.031.12.PZ +tiewrap plate

**Single-part order:**

11.031.1.PZ +tiewrap plate

Mounting bracket with bore

11.031.2.PZ +tiewrap plate

Mounting bracket with pin

For	Part No.	Part No.	Dim. A	Dim. B
E-Chain®	full set with tiewrap plate	full set without tiewrap plate	[mm]	[mm]
11.031. ►	11.031.12.PZ	11.031.12.P	16	42

For the preassembled mode please add the index [A1]...[A4] e.g. 11.031.12.PZ[A1]

Phone +49- (0) 22 03-96 49-800  
Fax +49- (0) 22 03-96 49-222

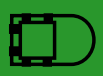

► page 5.39



Price index



UL94-V2 classifications upon request

- ❶ Version with larger pins and double stop dog for long service life and long unsupported length
- ❷ Mounting bracket with strain relief
- ❸ Dirt-repellent exterior
- ❹ One piece each link
- ❺ Stable design



Easy to assemble and to disassemble



When to use the Series 11.080:

- If space is restricted
- If many cables are arranged vertically adjacent



When not to use it:

- If snap-open links are required
  - ▶ similar width/height from Series Zipper, chapter 4
- If quick insertion of cables with preassembled connectors is required
  - ▶ similar width/height from Series Easy Chain®, chapter 3



Order example complete E-Chain®

Please indicate chain-lengths or number of links Example: 1 m or 33 links

1 m 11.080.038.0



E-Chain®

1 set 11.080.12PZ



Mounting bracket

**Unsupported length**

$FL_G$  = with straight upper run

$FL_B$  = with permitted sag

Further information ► Design, page 1.12

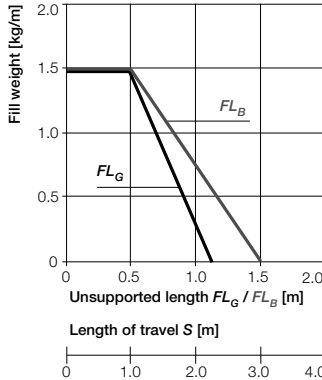
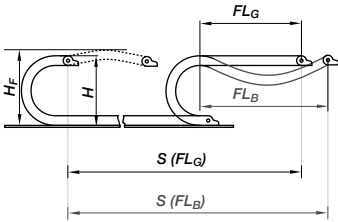

- $S$  = Length of travel
- $R$  = Bending radius
- $H$  = Nominal clearance height
- $H_F$  = Required clearance height
- $D$  = Overlength E-Chain® radius in final position
- $K = \pi \cdot R + \text{"safety"}$

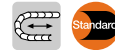
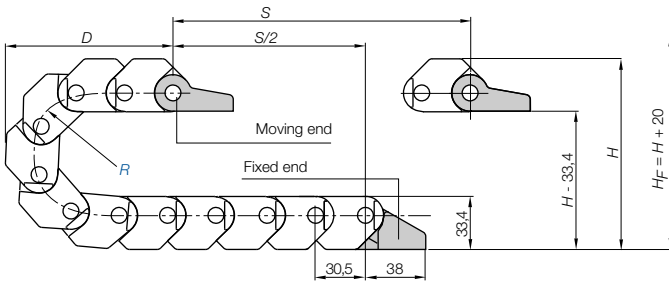

**Short travels - unsupported**

Unsupported E-Chains® feature positive camber over short travels. This must be accounted for when specifying the clearance height  $H_F$ . Please consult igus® if space is particularly restricted.

**Pitch = 30,5 mm/link Links/m = 33 (1.006,5 mm) Chain length =  $S/2 + K$**

$R$	038
$H$	110
$D$	90
$K$	185

The required clearance height:  
 $H_F = H + 20$  mm  
 (with 0,5 kg/m fill weight)

28

E2 mini  
Inner height: 28mm

Phone +49- (0) 22 03-96 49-800  
Fax +49- (0) 22 03-96 49-222



Speed / acceleration $FL_G$	max. 20 [m/s] / max. 200 [m/s <sup>2</sup> ]
Speed / acceleration $FL_B$	max. 3 [m/s] / max. 6 [m/s <sup>2</sup> ]
Gliding speed / acceleration (maximum)	max. 3 [m/s] / max. 10 [m/s <sup>2</sup> ]
Material - permitted temperature °C	igumid G / -40° up to +130° C
Flammability class, igumid G	VDE 0304 IIC UL94 HB

**Technical Data**



Details of material properties  
 ► page 1.38



► page 5.39

igus® E-ChainSystems®

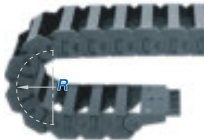
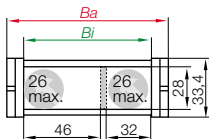

Series 11.080 E-Chain® - non snap-open

Part No.	Bl [mm]	Ba [mm]	R [mm]	Bending radii	Weight [kg/m]
11.080. <input type="text"/> .0	80	93	<input type="text" value="038"/>		~ 0,73

Supplement Part No. with required radius. Example: 11.080.  .0  
 0 = standard color, other colors ▶ page 1.39 · Pitch = 30,5 mm/link - Links/m = 33

Part No. structure

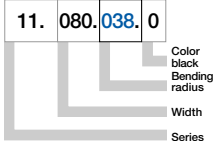

Phone +49- (0) 22 03-96 49-800  
 Fax +49- (0) 22 03-96 49-222

igus® GmbH  
 51147 Cologne

Internet: [www.igus.de](http://www.igus.de)  
 E-mail: [info@igus.de](mailto:info@igus.de)



**Polymer, one-piece**

- One-piece mounting bracket
- Corrosion-resistant
- Available preassembled
- Inner and outer attachment possible
- Available with or without strain relief tiewrap plates

Moving end with bore  
(outer link) 11...1P(Z)

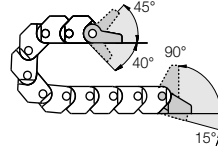

11...2P(Z) Fixed end  
with pin (inner link)

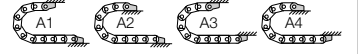

Possible installation conditions for assembled mounting brackets ▶ Order example "preassembled" below

11...1P(Z)  
Moving end

11...2P(Z)  
Fixed end

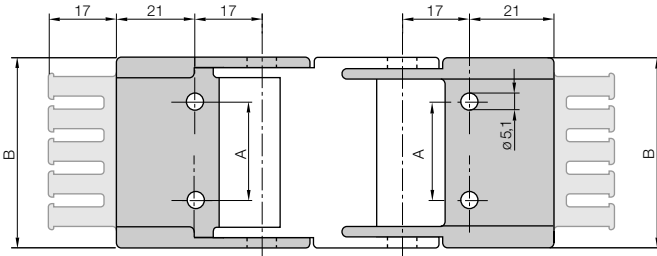

**Dimensions and order configurations**

Strain relief is possible on the moving end and/or the fixed end.

**Part No. structure**

11.080.12.PZ.A1

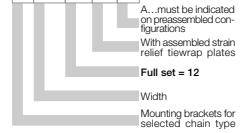

**Full set, for both ends:**

11.080.12.PZ +tiewrap plate

**Single-part order:**

11.080.1.PZ +tiewrap plate

Mounting bracket **with bore**

11.080.2.PZ +tiewrap plate

Mounting bracket **with pin**

For	Part No.	Part No.	Dim. A	Dim. B
E-chain*	full set <b>with</b> tiewrap plate	full set <b>without</b> tiewrap plate	[mm]	[mm]
11.080. ▶	11.080.12.PZ	11.080.12.P	65	93

For the **preassembled** mode please add the index **A1...A4** e.g. 11.080.12.PZ**A1**

Phone +49- (0) 22 03-96 49-800  
Fax +49- (0) 22 03-96 49-222

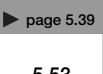



Price index



UL94-V2 classifications upon request

- ① Enlarged inner height
- ② Mounting bracket with strain relief
- ③ Dirt-repellent exterior
- ④ One piece each link



Easy to assemble and to disassemble



**When to use the Series 11.1 / 11.2:**

- If space is restricted
- If many cables are arranged vertically adjacent



**When not to use it:**

- If snap-open links are required
  - ▶ similar width/height from Series Zipper, chapter 4
- If quick insertion of cables with preassembled connectors is required
  - ▶ similar width/height from Series Easy Chain®, chapter 3



**Order example complete E-Chain®**

Please indicate chain-lengths or number of links **Example: 1 m or 33 links**

1 m 11.2.100.0



E-Chain®

1 set 102.12PZ



Mounting bracket



**Unsupported length**

$FL_G$  = with straight upper run

$FL_B$  = with permitted sag

Further information ► Design, page 1.12

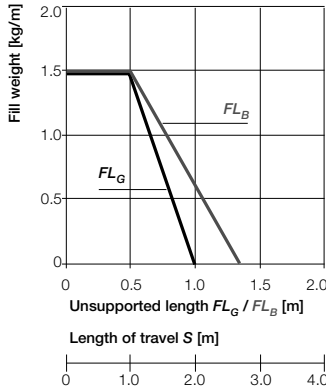
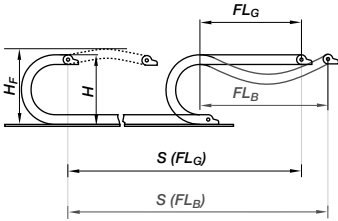

- $S$  = Length of travel
- $R$  = Bending radius
- $H$  = Nominal clearance height
- $H_F$  = Required clearance height
- $D$  = Overlength E-Chain® radius in final position
- $K = \pi \cdot R + \text{"safety"}$

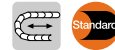
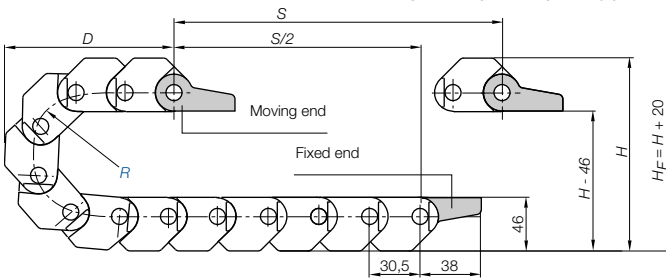

**Short travels - unsupported**

Unsupported E-Chains® feature positive camber over short travels. This must be accounted for when specifying the clearance height  $H_F$ . Please consult igus® if space is particularly restricted.

Pitch = 30,5 mm/link Links/m = 33 (1.006,5 mm) Chain length =  $S/2 + K$

R	040	063	075	100
H	149	195	219	269
D	105	128	140	165
K	212	275	305	395

The required clearance height:  
 $H_F = H + 20$  mm  
(with 0,5 kg/m fill weight)

41

E2 mini  
Inner height: 41 mm

Phone +49- (0) 22 03-96 49-800  
Fax +49- (0) 22 03-96 49-222



Speed / acceleration $FL_G$	max. 20 [m/s] / max. 200 [m/s²]
Speed / acceleration $FL_B$	max. 3 [m/s] / max. 6 [m/s²]
Gliding speed / acceleration (maximum)	max. 3 [m/s] / max. 10 [m/s²]
Material - permitted temperature °C	igumid G / -40° up to +130° C
Flammability class, igumid G	VDE 0304 IIC UL94 HB

**Technical Data**



Details of material properties  
► page 1.38



► page 5.39

igus® E-ChainSystems®

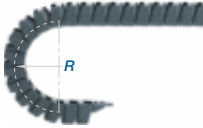
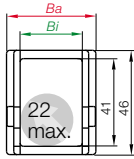

Series 11.1/11.2 E-Chain® - non snap-open

Part No.	<i>Bj</i> [mm]	<i>Ba</i> [mm]	<i>R</i> [mm]	Bending radii	Weight [kg/m]
11.1. <input type="text"/> .0	15	25,5	040	063 075 100	≈ 0,50
11.2. <input type="text"/> .0	25	35,5	040	063 075 100	≈ 0,53

Supplement Part No. with required radius. Example: 11.2.  .0

0 = standard color, other colors ▶ page 1.39 · Pitch = 30,5 mm/link - Links/m = 33

Phone +49- (0) 22 03-96 49-800  
Fax +49- (0) 22 03-96 49-222

Part No. structure

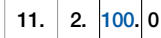

Color  
black  
Bending  
radius  
Width  
Series



igus® GmbH  
51147 Cologne

Internet: [www.igus.de](http://www.igus.de)  
E-mail: [info@igus.de](mailto:info@igus.de)



**Polymer, one-piece**

- One-piece mounting bracket
- Corrosion-resistant
- Available preassembled
- Inner and outer attachment possible
- Available with or without strain relief tiewrap plates

Moving end with bore  
(outer link) 10...1P(Z)

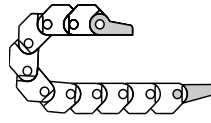

10...2P(Z) Fixed end  
with pin (inner link)



Possible installation condition for assembled mounting brackets ▶ Order example "preassembled" below



10...1P(Z)  
Moving end

10...2P(Z)  
Fixed end

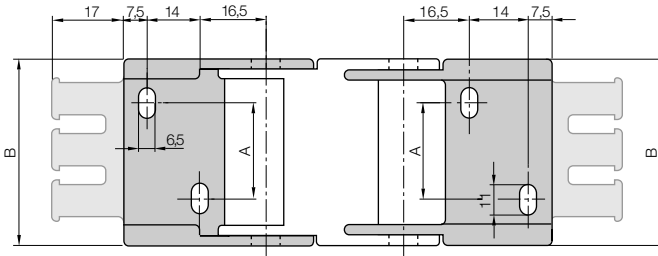

**Dimensions and order configurations**

Strain relief is possible on the moving end and/or the fixed end.

**Part No. structure**

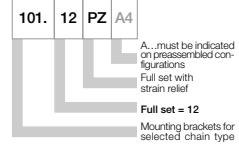

**Full set, for both ends:**

101.12|PZ + tiewrap plate

**Single-part order:**

101.1|PZ + tiewrap plate

Mounting bracket **with bore**

101.2|PZ + tiewrap plate

Mounting bracket **with pin**

For	Part No.	Part No.	Dim. A	Dim. B
E-Chain®	full set <b>with</b> tiewrap plate	full set <b>without</b> tiewrap plate	[mm]	[mm]
11.1. ▶	101.12 PZ	101.12 P	-	26
11.2. ▶	102.12 PZ	102.12 P	10	36

For the **preassembled** mode please add the index **A4** e.g. 101.12|PZ**A4**

**Also available:**

**Option: Steel, one-piece**

- One-piece mounting bracket
- Available pre-assembled

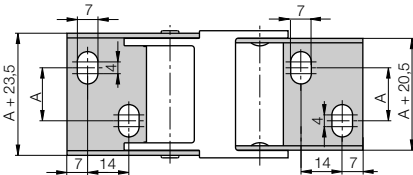

For	Part No.	Part No.	Dim. A*	Dim. B*
E-Chain®	one-piece	set two-piece	[mm]	[mm]
11.1 ▶	101.12	100.12	-	3
11.2 ▶	102.12	100.12	10	13

\*A may be equal to B owing to slot

**Option: Steel, two-piece**

- 1 set, suitable for all widths
- Inner and outer attachment possible

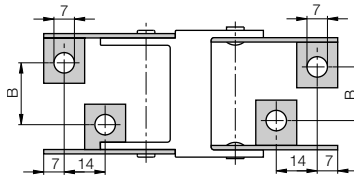

Phone +49- (0) 22 03-96 49-800  
Fax +49- (0) 22 03-96 49-222

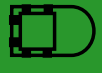

▶ page 5.39



Price index



Cleanroom Class 1 (ISO class 3)  
for Series 14, tested by the Dryden  
Engineering Company, California



Special equipment:  
Electrically conductive ESD/ATEX  
version upon request



UL94-V2 classifications

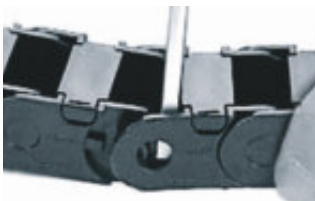

Easy to assemble and to disassemble



When to use the Series 14:

- For applications with low loads
- Fast installation of the cables



When not to use it:

- For gliding applications  
▶ Series 15 Zipper, page 4.18
- For long unsupported lengths  
▶ Series 15 Zipper, page 4.18

- 1 Snap-open along inner radius with film-hinge
- 2 Flammability class UL V2
- 3 Mounting bracket with strain relief
- 4 Dirt-repellent exterior
- 5 For gliding applications  
▶ Series 15 Zipper, page 4.18
- 6 For longer unsupported lengths  
▶ Series 15 Zipper, page 4.18



Order example complete E-Chain®

Please indicate chain-lengths or number of links Example: 1 m or 33 links

1 m 14.2.038.0



E-Chain®

1 set 114.2.12PZ



Mounting bracket

**Unsupported length**

$FL_G$  = with straight upper run

$FL_B$  = with permitted sag

Further information ► **Design, page 1.12**

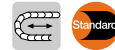
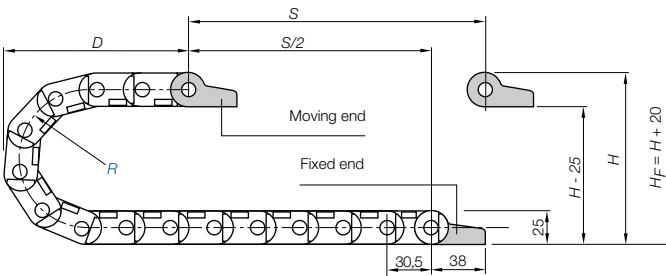
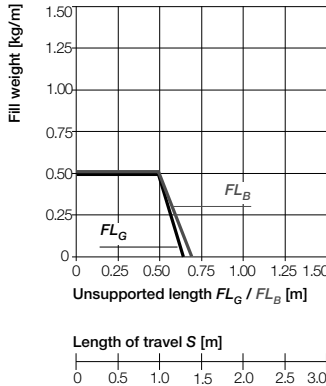
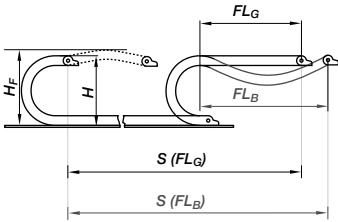

**Short travels - unsupported**

Unsupported E-Chains® feature positive camber over short travels. This must be accounted for when specifying the clearance height  $H_f$ . Please consult igus® if space is particularly restricted.

**Pitch = 30,5 mm/link Links/m = 33 (1.006,5 mm) Chain length =  $S/2 + K$**

R	028	038	048	075	100	125
H	82	102	122	177	227	277
D	71	81	91	120	145	170
K	150	185	215	300	375	455

The required clearance height:  
 $H_f = H + 20$  mm  
 (with 0,5 kg/m fill weight)

**Low cost PVC-control cable for medium load requirements - Chainflex® CF140.UL**

UL, flame-retardant, shielded

Further information: [www.igus.de/en/CF140UL](http://www.igus.de/en/CF140UL)

CHAINFLEX® CF140.UL



TIP!

Speed / acceleration $FL_G$	max. 20 [m/s] / max. 200 [m/s <sup>2</sup> ]
Speed / acceleration $FL_B$	max. 3 [m/s] / max. 6 [m/s <sup>2</sup> ]
Gliding speed / acceleration (maximum)	max. 3 [m/s] / max. 10 [m/s <sup>2</sup> ]
Material - permitted temperature °C	igumid G / -40° up to +130° C
Flammability class, igumid G	VDE 0304 IIC UL94 V2

**Technical Data**



Details of material properties  
 ► page 1.38



E2 mini  
 Inner height: 20 mm

Phone +49- (0) 22 03-96 49-800  
 Fax +49- (0) 22 03-96 49-222



► page 5.39

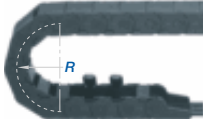
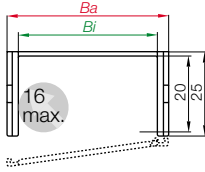

## Series 14 E-Chain® - snap-open along inner radius

Part No.	Bj [mm]	Ba [mm]	R [mm]	Bending radii						Weight [kg/m]
14.1.□.□.0	15	26	028	038	048	075	100	125	~ 0,31	
14.2.□.□.0	25	36	028	038	048	075	100	125	~ 0,32	
14.3.□.□.0	38	49	028	038	048	075	100	125	~ 0,40	
14.4.□.□.0	50	61	028	038	048	075	100	125	~ 0,41	

Supplement Part No. with required radius. Example: 14.02.038.0

0 = standard color, other colors ▶ page 1.39 - Pitch = 30,5 mm/link - Links/m = 33

## Part No. structure

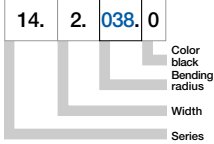

Phone +49- (0) 22 03-96 49-800  
Fax +49- (0) 22 03-96 49-222

igus® GmbH  
51147 Cologne



Cost effective cable  
guidance with E2 mini



Internet: [www.igus.de](http://www.igus.de)  
E-mail: [info@igus.de](mailto:info@igus.de)



**Option Polymer, one-piece**

- One-piece mounting bracket
- Corrosion-resistant
- Available preassembled
- Inner and outer attachment possible
- Available with or without strain relief tiwrap plates

Moving end with bore (outer link) 114...1P(Z)

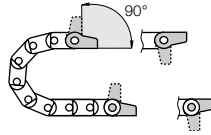

114...2P(Z) Fixed end with pin (inner link)



Possible installation conditions for assembled mounting brackets ▶ Order example "preassembled" below

114...1P(Z)  
Moving end

114...2P(Z)  
Fixed end

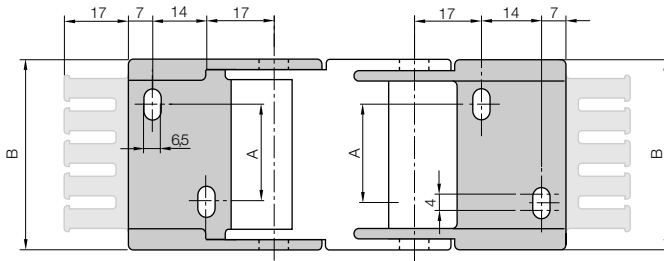

**Dimensions and order configurations**

Strain relief is possible on the moving end and/or the fixed end.

**Part No. structure**

114. 2. 12 PZ A1

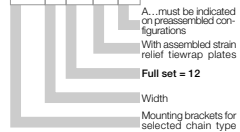

**Full set, for both ends:**

114. 2. 12 PZ +tiwrap plate

**Single-part order:**

114. 2. 1 PZ +tiwrap plate

Mounting bracket with bore

114. 2. 2 PZ +tiwrap plate

Mounting bracket with pin

For	Part No.	Part No.	Dim. A	Dim. B
E-Chain*	full set with tiwrap plate	full set without tiwrap plate	[mm]	[mm]
14.1. ▶	114.1. 12 PZ	114.1. 12 P	-	26,3
14.2. ▶	114.2. 12 PZ	114.2. 12 P	10	36,3
14.3. ▶	114.3. 12 PZ	114.3. 12 P	23	49,3
14.4. ▶	114.4. 12 PZ	114.4. 12 P	35	61,3

For the preassembled mode please add the index A1 ... A4 e.g. 114.2. 12 PZ A1



**Quicksnap** - the complete, detachable mounting unit, upon request



**Quickfix** - mounting bracket with dowel, upon request

**Additional Features**



▶ page 5.39



● ● ● Price index



**Special equipment:**  
Electrically conductive ESD/ATEX  
version upon request



**UL94-V2 classifications**  
upon request

- ❶ Large pins and double stop dog for long service life and long unsupported length
- ❷ To be opened along outer radius (Series B15) and/or along inner radius (Series B15i), these Series can be combined
- ❸ Mounting bracket with integrated strain relief
- ❹ Dirt-repellent exterior
- ❺ Interior separation available



Easy to assemble and to disassemble



**When to use the Series B15i/B15:**

- If opening is necessary
- If connection options are required (Quicksnap, Quickfix,...)
- If a small but very stable chain is required



**When not to use it:**

- If opening of the links is not necessary
  - ▶ Series 10, page 5.40
- If torsion occurs
  - ▶ Series E14 Easy Chain®, page 3.32



**Order example complete E-Chain®**

Please indicate chain-lengths or number of links **Example: 1 m or 33 links**

1 m **B15.025.038.0**



**E-Chain®**

with 2 separators **154** assembled every 2<sup>nd</sup> link



**Interior separation**

1 set **1025.12PZ**



**Mounting bracket**

**Unsupported length**

$FL_G$  = with straight upper run

$FL_B$  = with permitted sag

Further information ► Design, page 1.12

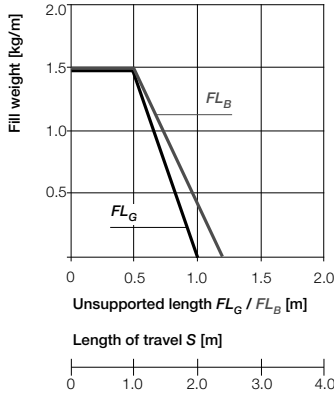
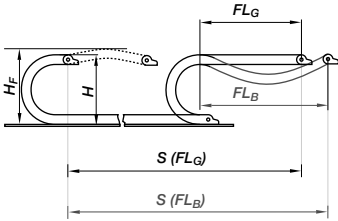

- S = Length of travel
- R = Bending radius
- H = Nominal clearance height
- $H_F$  = Required clearance height
- D = Overlength E-Chain\* radius in final position
- $K = \pi \cdot R + \text{"safety"}$

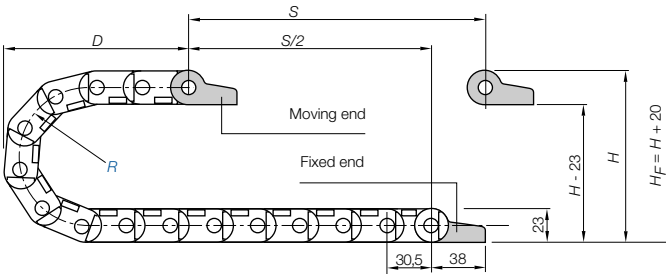

**Short travels - unsupported**

Unsupported E-Chains\* feature positive camber over short travels. This must be accounted for when specifying the clearance height  $H_F$ . Please consult igus\* if space is particularly restricted.

Pitch = 30,5 mm/link Links/m = 33 (1.006,5 mm) Chain length =  $S/2 + K$

R	038	048	075	100	110	125	145	180
H	100	120	175	225	245	275	315	385
D	80	90	120	145	155	170	190	225
K	185	215	300	375	410	455	520	630

The required clearance height:  
 $H_F = H + 20$  mm  
(with 0,5 kg/m fill weight)

**Braiding in bundles for long travels - Chainflex® CF5**

oil-proof in accordance with VDE, flame-retardant  
Further information: [www.igus.de/en/CF5](http://www.igus.de/en/CF5)

TIP!

CHAINFLEX® CF5



Speed / acceleration $FL_G$	max. 20 [m/s] / max. 200 [m/s <sup>2</sup> ]
Speed / acceleration $FL_B$	max. 3 [m/s] / max. 6 [m/s <sup>2</sup> ]
Gliding speed / acceleration (maximum)	max. 3 [m/s] / max. 10 [m/s <sup>2</sup> ]
Material - permitted temperature °C	igumid G / -40° up to +130° C
Flammability class, igumid G	VDE 0304 IIC UL94 HB

**Technical Data**



Details of material properties  
► page 1.38



E2 mini  
Inner height: 17 mm

Phone +49- (0) 22 03-96 49-800  
Fax +49- (0) 22 03-96 49-222



► page 5.39

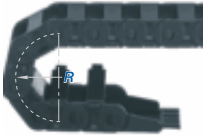
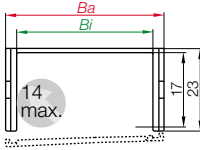

Series B15i E-Chain® - snap-open along inner radius

Part No.	Bj [mm]	Ba [mm]	R [mm]	Bending radii								Weight [kg/m]
B15i.015.	15	26	038	048	075	100	110	125	145	180	~ 0,35	
B15i.025.	25	36	038	048	075	100	110	125	145	180	~ 0,40	
B15i.038.	38	49	038	048	075	100	110	125	145	180	~ 0,46	
B15i.050.	50	61	038	048	075	100	110	125	145	180	~ 0,52	
B15i.5.	63	76	038	048	075	100	110	125	145	180	~ 0,63	
B15i.6.	80	94	038	048	075	100	110	125	145	180	~ 0,70	
B15i.7.	100	113	038	048	075	100	110	125	145	180	~ 0,76	

Supplement Part No. with required radius. Example: B15i.025.038.0

0 = standard color, other colors ▶ page 1.39 · Pitch = 30,5 mm/link - Links/m = 33

Part No. structure

B15i. 025. 038. 0

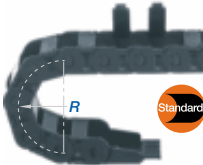
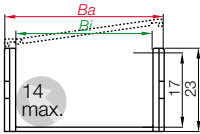

Series B15 - snap-open along outer radius - Standard!

Part No.	Bj [mm]	Ba [mm]	R [mm]	Bending radii								Weight [kg/m]
B15.015.	15	26	038	048	075	100	110	125	145	180	~ 0,35	
B15.025.	25	36	038	048	075	100	110	125	145	180	~ 0,40	
B15.038.	38	49	038	048	075	100	110	125	145	180	~ 0,46	
B15.050.	50	61	038	048	075	100	110	125	145	180	~ 0,52	
B15.5.	63	76	038	048	075	100	110	125	145	180	~ 0,63	
B15.6.	80	94	038	048	075	100	110	125	145	180	~ 0,70	
B15.7.	100	113	038	048	075	100	110	125	145	180	~ 0,76	

Supplement Part No. with required radius. Example: B15.025.038.0

0 = standard color, other colors ▶ page 1.39 · Pitch = 30,5 mm/link - Links/m = 33

Part No. structure

B15. 025. 038. 0



### Option 1: Vertical Separators

Vertical Separators are used if a vertical subdivision of the E-Chain® interior is required -

By standard Vertical Separators are assembled every other E-Chain® link

- Standard subdivision with Vertical Separator, slotted 154, for combinations with Full-Width Shelf 111.X

Vert. Separator, slotted		1,5	
unassembled	153		
assembled	154	8	

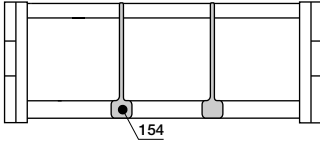

E2 mini  
Inner height: 17 mm

### Option 2: Full-Width Shelves

For applications involving many thin cables with similar or identical diameters

- Side Plate 156 can be combined with Vertical Separator, slotted 154 and Full-Width Shelf 111.X

Side Plate		1,5
unassembled	155	
assembled	156	4,75

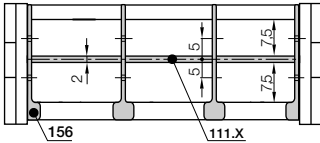

Width X [mm]	Part No. unassembled	Part No. assembled
015	110.15	111.15
025	110.25	111.25
038	110.38	111.38
050	110.50	111.50

Width X [mm]	Part No. unassembled	Part No. assembled
063	110.63	111.63
080	110.80	111.80
100	110.100	111.100

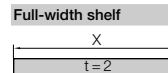

Phone +49- (0) 22 03-96 49-800  
Fax +49- (0) 22 03-96 49-222

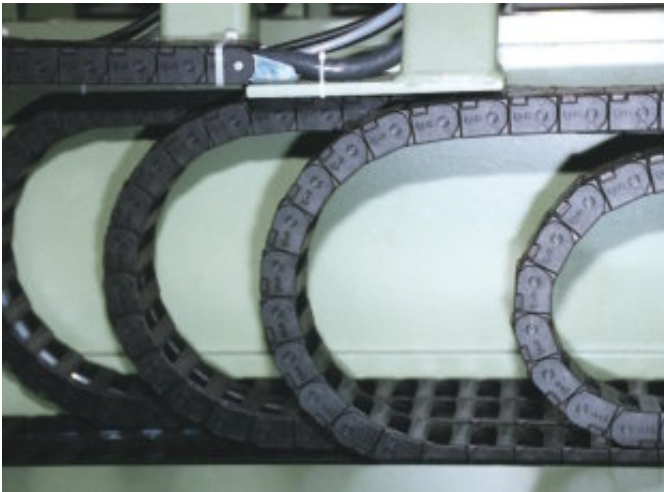

5 Series 15 E-Chains®, 3 side by side, 2 sets nested - the bending radii are exactly adjusted to one another

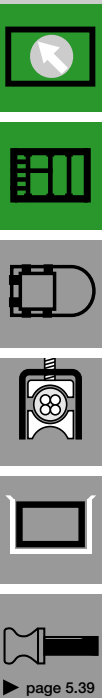

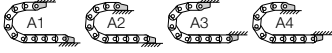

Possible installation conditions for assembled mounting brackets ▶ Order example "preassembled" below

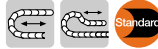

**The Standard - option polymer - pivoting**

- Recommended for unsupported and gliding applications
- Well suited for tight installation conditions
- Strain relief with detachable tiewrap plates
- Variable traverse angle for flexible assembly

Moving end with bore  
(outer link) 10...3P(Z)

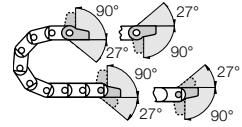

10...4P(Z) Fixed end  
with pin (inner link)

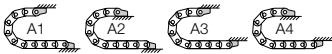

Possible installation conditions for assembled mounting brackets ▶ Order example "preassembled" below



**Option polymer - locking**

- Recommended for unsupported and gliding applications
- At very high speed and/or acceleration
- If space is limited for height (the  $H_F$  measurement)

Moving end with bore  
(outer link) 10...1P(Z)

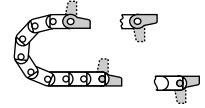

10...2P(Z) Fixed end  
with pin (inner link)

**Dimensions and order configurations**

Strain relief is possible on the moving end and/or the fixed end.

Part No. structure (pivoting)

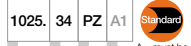

A... must be indicated on preassembled configurations  
Full set with strain relief  
Full set pivoting = 34  
Mounting brackets for selected chain type

Full set, for both ends:

1025. 34 PZ +tiewrap plate

Single-part order:

1025. 3 PZ +tiewrap plate

Mounting bracket with bore

1025. 4 PZ +tiewrap plate

Mounting bracket with pin

Part No. structure (locking)



A... must be indicated on preassembled configurations  
Full set with strain relief  
Full set locking = 12  
Mounting brackets for selected chain type

Full set, for both ends:

1025. 12 PZ +tiewrap plate

Single-part order:

1025. 1 PZ +tiewrap plate

Mounting bracket with bore

1025. 2 PZ +tiewrap plate

Mounting bracket with pin

10...3P(Z) Standard! (pivoting)  
10...1P(Z) (locking)

Moving end

For E-Chain:  
B15i-B15.015 bis  
B15i-B15.050

For E-Chain:  
B15i-B15.5 to  
B15i-B15.7

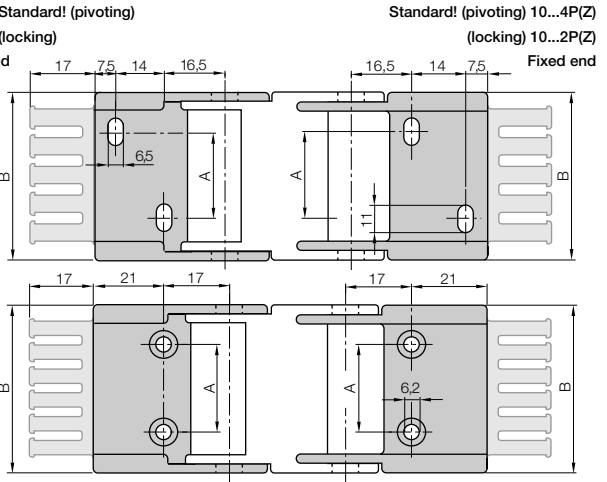

For E-Chain*	Part No. full set with tiewrap plate	Part No. full set without tiewrap plate	Dim. A [mm]	Dim. B [mm]
B15i-B15.015. ▶	1015. <input type="checkbox"/> PZ	1015. <input type="checkbox"/> P	-	25,5
B15i-B15.025. ▶	1025. <input type="checkbox"/> PZ	1025. <input type="checkbox"/> P	10	35,5
B15i-B15.038. ▶	1038. <input type="checkbox"/> PZ	1038. <input type="checkbox"/> P	23	48,5
B15i-B15.050. ▶	1050. <input type="checkbox"/> PZ	1050. <input type="checkbox"/> P	35	60,5
B15i-B15.5. ▶	105. <input type="checkbox"/> PZ	105. <input type="checkbox"/> P	48	75,0
B15i-B15.6. ▶	106. <input type="checkbox"/> PZ	106. <input type="checkbox"/> P	65	92,0
B15i-B15.7. ▶	107. <input type="checkbox"/> PZ	107. <input type="checkbox"/> P	85	112,0

Please add the Part No. with the requested index - 34 for the pivoting configuration

e.g. 1025. 34 PZ or 12 for the locking configuration e.g. 1025. 12 PZ

For the preassembled mode please add the index A1...A4 e.g. 1025. 34 PZ A1

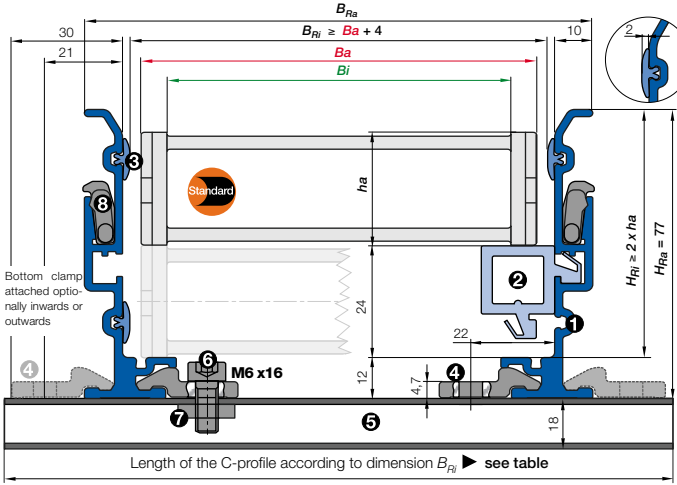

- $B_a$  = Outer width E-Chains<sup>®</sup> / E-Tube
- $B_i$  = Inner width E-Chains<sup>®</sup> / E-Tube
- $h_a$  = Outer height E-Chains<sup>®</sup> / E-Tube
- $H_{Ri}$  = Inner trough height
- $H_{Ra}$  = Outer trough height
- $B_{Ri}$  = Inner trough width ► depends on dim.  $B_a$
- $B_{Ra}$  = Outer trough width
- $n_{Mon}$  = Number of installation sets (left/right)
- $n_{Ri}$  = Number of troughs sets (left/right)
- $H_{Ri} \geq 2 \cdot h_a$
- $B_{Ri} \geq B_a + 4$
- = Guide trough set    ● = Glide bar
- = Installation set "Basic"    ● = C-profile

**Installation set "Basic" with C-profile**  
 Bottom Clamp attached optionally inwards or outwards

B15.038.038.0 ► Order example

$B_{Ri}$ [mm]	Part No.	
	attached inwards	attached outwards
.015 30	-	960.30.125
.025 40	-	960.30.150
.038 53	-	960.30.150
.050 65	960.30.125	960.30.175
.5 80	960.30.125	960.30.175
.6 98	960.30.150	960.30.200
.7 117	960.30.175	960.30.225

- **Components, trough "Basic":** ① Trough side parts, aluminum, 2 m ② Glide bar, plastic, 2 m ③ Glide strips, plastic, 2 m (without glide strips on request)
- **Components, installation set "Basic":** ④ Bottom clamp, aluminum ⑤ C-profile, steel galvanized ⑥ Screw M6 x 16 ⑦ Sliding nut M6 ⑧ Interface connector, plastic

**Order example: Length of travel 30 m - Center mounted for Series B15.038.038.0 with  $B_{Ri} = 53$**

- Guide trough set (set of 2 trough side parts, incl. glide strips) **without** glide bar  
 Order text: 16 m guide trough without glide bar (8 x 2 m sections) **Part No. 970.30.SL**
- Guide trough set (set of 2 trough side parts, incl. glide strips) **with** glide bar  
 Order text: 16 m guide trough with glide bar (8 x 2 m sections) **Part No. 970.31.SL**
- Installation set "Basic" complete (guide trough-sets + 1)  
 Order text: 17 installation sets "Basic" **Part No. 960.30.150**

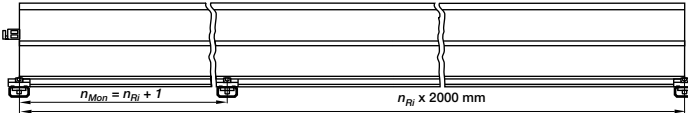

Principle sketch: Number of installation sets to be installed = **Number of trough sections + 1**

**Other guide trough systems**

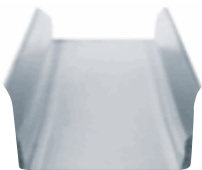

"Single-piece steel guide troughs" with trough glide surface ► **chapter 9**



"Snap in trough" easy and fast assembly, favorable price due to simple structure, narrow design ► **chapter 9**



## E2 mini | Series B17

● ● ● Price index



**Special equipment:**  
Electrically conductive ESD/ATEX  
version upon request



UL94-V2 classifications  
upon request

- ❶ Snap-open with film-hinge
  - ❷ Small pitch for very quiet operation
  - ❸ Mounting bracket with integrated strain relief
  - ❹ Dirt-repellent exterior
  - ❺ Small E-Chain® with large inner height
  - ❻ Interior separation available
  - ❼ Quick-opening configuration
- **Series 17 Zipper**, page 4.24
- ❸ Closed, easy to open version
  - **Series R17 Zipper Tube**, page 4.42
  - ❹ If torsion occurs
  - **Series E16 Easy Chain**®, page 3.42



Easy to assemble and to disassemble



**When to use the Series B17:**

- If opening is necessary
- If a rather small chain with broad inner width is required
- If reverse bending radius is required



**When not to use it:**

- If quick opening of the links is required
  - **Series 17 Zipper**, page 4.24
- If quick insertion of cables with preassembled connectors is required
  - **Series E16 Easy Chain**®, page 3.42



**Order example complete E-Chain®**

Please indicate chain-lengths or number of links **Example: 1 m or 33 links**

1 m **B17.1.063.0**

**E-Chain®**

with 2 separators **172** assembled every 2<sup>nd</sup> link

**Interior separation**

1 set **117.1.12PZ**

**Mounting bracket**



**Unsupported length**

$FL_G$  = with straight upper run

$FL_B$  = with permitted sag

Further information ► **Design, page 1.12**

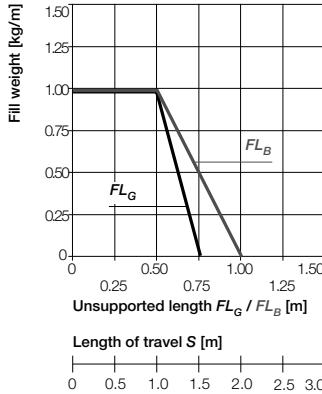
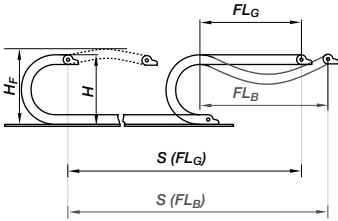

- $S$  = Length of travel
- $R$  = Bending radius
- $H$  = Nominal clearance height
- $H_F$  = Required clearance height
- $D$  = Overlength E-Chain\* radius in final position
- $K = \pi \cdot R + \text{"safety"}$

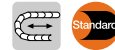
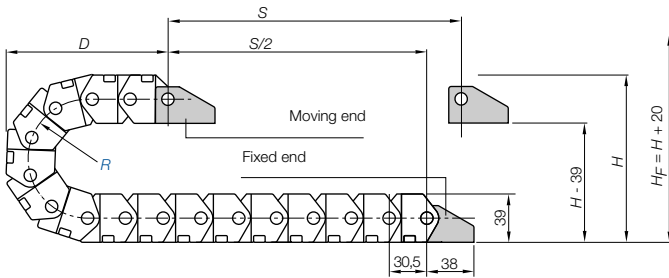

**Short travels - unsupported**

Unsupported E-Chains\* feature positive camber over short travels. This must be accounted for when specifying the clearance height  $H_F$ . Please consult igus\* if space is particularly restricted.

**Pitch = 30,5 mm/link Links/m = 33 (1.006,5 mm) Chain length =  $S/2 + K$**

R	048*	063	075	100	125
H	135	165	189	239	289
D	100	115	130	155	180
K	220	275	305	395	475

\* Radius 048 not for B17.5 and B17.7

The required clearance height:  
 $H_F = H + 25 \text{ mm}$   
 (with 1,5 kg/m fill weight)

**Chip protection**

Fully enclosed E-Tube with zipper opening mechanism ● Protection against dirt and chips ● Superfast opening of interconnected lids ● Modular design - tool-free lengthening and shortening ● Small pitch for low noise, smooth operation, high acceleration  
**Zipper E-Tube R17, inner height 32 mm ► from page 4.42**



Speed / acceleration $FL_G$	max. 20 [m/s] / max. 200 [m/s <sup>2</sup> ]
Speed / acceleration $FL_B$	max. 3 [m/s] / max. 6 [m/s <sup>2</sup> ]
Gliding speed / acceleration (maximum)	max. 3 [m/s] / max. 10 [m/s <sup>2</sup> ]
Material - permitted temperature °C	igumid G / -40° up to +130° C
Flammability class, igumid G	VDE 0304 IIC UL94 HB

**Technical Data**



**Details of material properties**  
 ► page 1.38



E2 mini  
 Inner height: 32 mm

Phone +49- (0) 22 03-96 49-800  
 Fax +49- (0) 22 03-96 49-222



► page 5.39

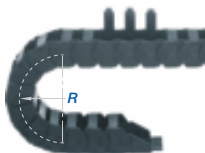
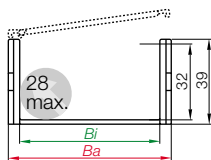

Series B17 - snap-open along outer radius

Part No.	Bi [mm]	Ba [mm]	R [mm]	Bending radii	Weight [kg/m]
B17.1. <input type="text"/> .0	15	25,5	048	063 075 100 125	~ 0,52
B17.2. <input type="text"/> .0	25	35,5	048	063 075 100 125	~ 0,59
B17.3. <input type="text"/> .0	38	48,5	048	063 075 100 125	~ 0,65
B17.4. <input type="text"/> .0	50	60,5	048	063 075 100 125	~ 0,70
B17.5. <input type="text"/> .0	63	76,0	063	075 100 125	~ 0,83
B17.6. <input type="text"/> .0	80	93,0	048	063 075 100 125	~ 0,92
B17.7. <input type="text"/> .0	100	113,0	063	075 100 125	~ 1,06

Supplement Part No. with required radius. Example: B17.1..0

0 = standard color, other colors ▶ page 1.39 · Pitch = 30,5 mm/link - Links/m = 33

Part No. structure

B17. 1.  .0



Phone +49- (0) 22 03-96 49-800  
 Fax +49- (0) 22 03-96 49-222

igus® GmbH  
 51147 Cologne

Short travel lengths  
 and high accelerations  
 with Series E2 mini

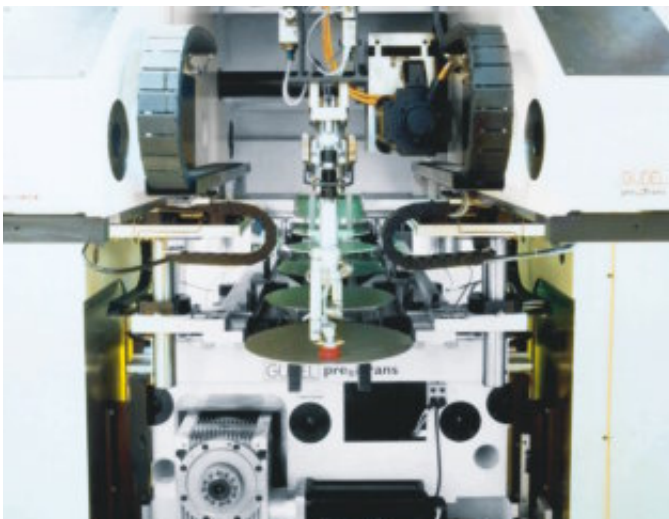

Internet: [www.igus.de](http://www.igus.de)  
 E-mail: [info@igus.de](mailto:info@igus.de)

### Option 1: Vertical Separators

Vertical Separators are used if a vertical subdivision of the E-Chain® interior is required -

By standard Vertical Separators are assembled every other E-Chain® link

- Standard subdivision with Vertical Separator, slotted 172B (for B17.1 to B17.4) or,

Vertical Separator, slotted 174B (for B17.5 to B17.7) for combinations with Full-Width Shelf 111.X

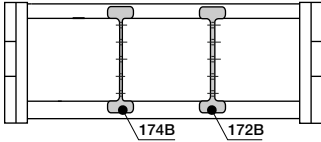

Vert. Separator, slotted  
for B17.1 to B17.4

unassembled	171B
assembled	172B



Vert. Separator, slotted  
for B17.5 to B17.7

unassembled	173B
assembled	174B



E2 mini  
Inner height: 32 mm

### Option 2: Full-Width Shelves

For applications involving many thin cables with similar or identical diameters

- Side Plate 156 can be combined with Vertical Separator, slotted 172B (for B17.1 to B17.4) or Vertical Separator, slotted 174B (for B17.5 to B17.7) and Full-Width Shelf 111.X

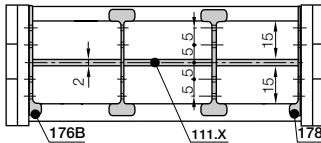

Side Plate  
for B17.1 to B17.4

unassembled	175B
assembled	176B



Side Plate  
for B17.5 to B17.7

unassembled	177
assembled	178



Width X [mm]	Part No.	
	unassembled	assembled
015	110.15	111.15
025	110.25	111.25
038	110.38	111.38
050	110.50	111.50

Width X [mm]	Part No.	
	unassembled	assembled
063	110.63	111.63
080	110.80	111.80
100	110.100	111.100

Full-Width Shelf

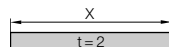

Phone +49- (0) 22 03-96 49-800  
Fax +49- (0) 22 03-96 49-222



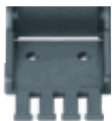

**Polymer, one-piece**

- One-piece mounting bracket
- Corrosion-resistant
- Available preassembled
- Inner and outer attachment possible
- Available with or without integrated strain relief tiwrap plates

Moving end with bore  
(outer link) 117...1P(Z)

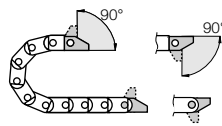

117...2P(Z) Fixed end  
with pin (inner link)

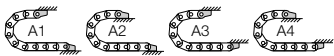

Possible installation conditions for assembled mounting brackets ▶ Order example "preassembled" below

**Dimensions and order configurations**

Strain relief is possible on the moving end and/or the fixed end.

117...1P(Z)

Moving end

117...2P(Z)

Fixed end

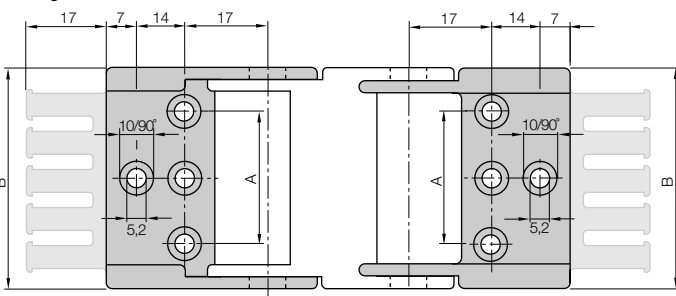

117.1.12P(Z): center bores only

117.2.12P(Z) - 117.7.12P(Z): outer bores only

**Part No. structure**

117. 1. 12 PZ A1

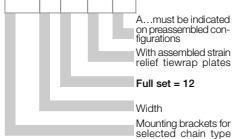

A... must be indicated on preassembled configurations  
With assembled strain relief tiwrap plates  
Full set = 12  
Width  
Mounting brackets for selected chain type

**Full set, for both ends:**

117.1.12PZ +tiwrap plate

**Single-part order:**

117.1.1PZ +tiwrap plate

Mounting bracket with bore

117.1.2PZ +tiwrap plate

Mounting bracket with pin

For E-Chain*	Part No. full set with tiwrap plate	Part No. full set without tiwrap plate	Number of teeth	Dim. A [mm]	Dim. B [mm]
B17.1. ▶	117.1. 12 PZ	117.1. 12 P	2	-	25,5
B17.2. ▶	117.2. 12 PZ	117.2. 12 P	3	12	35,5
B17.3. ▶	117.3. 12 PZ	117.3. 12 P	4	25	48,5
B17.4. ▶	117.4. 12 PZ	117.4. 12 P	5	37	60,5
B17.5. ▶	117.5. 12 PZ	117.5. 12 P	6	48	76,0
B17.6. ▶	117.6. 12 PZ	117.6. 12 P	8	65	93,0
B17.7. ▶	117.7. 12 PZ	117.7. 12 P	10	85	113,0

For the preassembled mode please add the index A1 ... A4 e.g. 117.1. 12 PZ A1

Phone +49- (0) 22 03-96 49-800  
Fax +49- (0) 22 03-96 49-222

igus® GmbH  
51147 Cologne

Internet: www.igus.de  
E-mail: info@igus.de



E2 mini  
Inner height: 32 mm

Phone +49- (0) 22 03-96 49-800  
Fax +49- (0) 22 03-96 49-222



## Low cost, oil-proof, shielded - Chainflex® CF211 - measuring system cable

TIP!

oil-proof in accordance with VDE, flame-retardant, PVC outer jacket, bending radius 10xd  
Further information: [www.igus.de/en/CF211](http://www.igus.de/en/CF211)

CHAINFLEX® CF211



▶ page 5.39

● ● ● Price index



**Special equipment:**  
Electrically conductive ESD/ATEX  
version upon request



**UL94-V2 classifications**  
upon request



Easy to assemble and to disassemble



#### When to use the Series F17:

- For applications with low loads
- If a quick access to cables is required
- For small bending radii with a huge interior height is required
- For fast applications
- If a small E-Chain® with huge interior height is required
- If aesthetic design is required



#### When not to use it:

- If cable installation without opening lids is possible
  - ▶ Series 11.080 E2 mini, page 5.50
- If extremely quick, zipper-like access to cables is required
  - ▶ Serie R17 Zipper, page 4.42
- For gliding applications
  - ▶ Series 2600/2700/2650/2680 E2/000, page 5.106

- 1 Snap-open along inner radius with film-hinge
- 2 Small pitch for smooth running
- 3 Mounting bracket with integrated strain relief
- 4 Dirt-repellent exterior
- 5 One-piece, small E-Chain® with great inner height
- 6 Small Bending radii
- 7 Elegant design
- 8 Closed outside

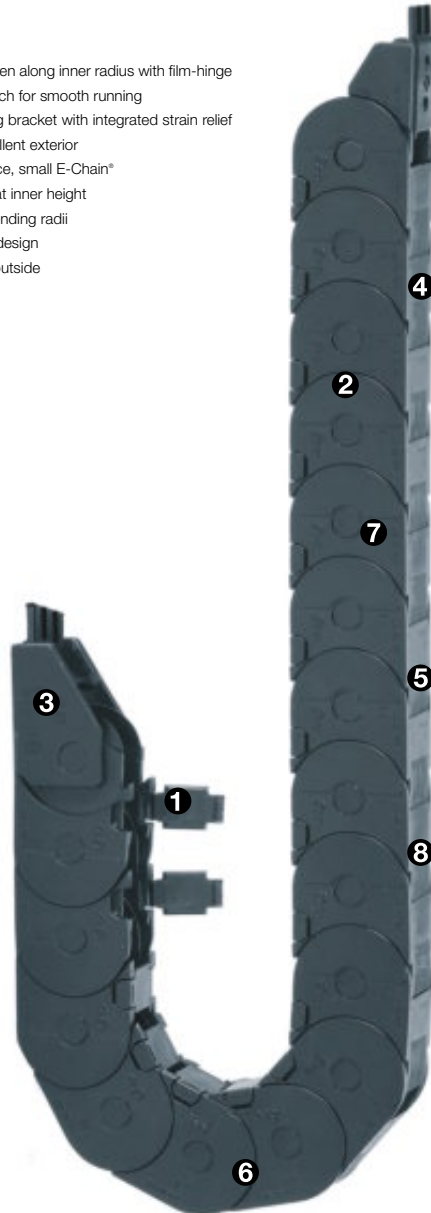

#### Order example complete E-Tube

Please indicate chain-lengths or number of links **Example: 1 m or 33 links**

1 m **F17.025.063.0**

E-Chain®

with 2 separators **R172** assembled every 2<sup>nd</sup> link

Interior separation

1 set **117.025.12PZ**

Mounting bracket

**Unsupported length**

$FL_G$  = with straight upper run

$FL_B$  = with permitted sag

Further information ► Design, page 1.12

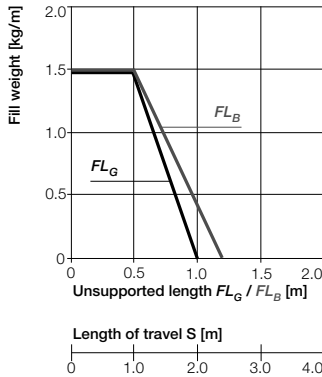
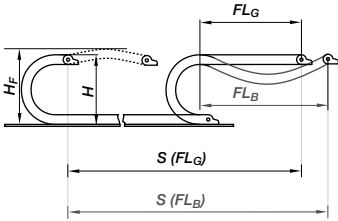

- $S$  = Length of travel
- $R$  = Bending radius
- $H$  = Nominal clearance height
- $H_F$  = Required clearance height
- $D$  = Overlength E-Chain\* radius in final position
- $K = \pi \cdot R + \text{"safety"}$

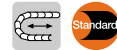
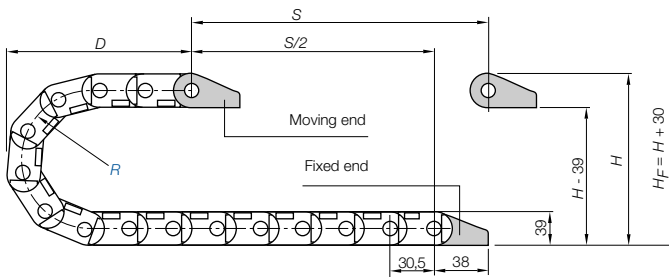

**Short travels - unsupported**

Unsupported E-Chains\* feature positive camber over short travels. This must be accounted for when specifying the clearance height  $H_F$ . Please consult igus\* if space is particularly restricted.

Pitch = 30,5 mm/link    Links/m = 33 (1.006,5 mm)    Chain length =  $S/2 + K$

$R$	048
$H$	135
$D$	100
$K$	220

The required clearance height:  
 $H_F = H + 30$  mm  
 0,5 kg/m fill weight)



E2 mini  
Inner height: 32 mm

Phone +49- (0) 22 03-96 49-800  
Fax +49- (0) 22 03-96 49-222



**Low cost PVC control cable for medium load requirements - Chainflex® CF130.UL**

UL, flame-retardant

Further information: [www.igus.de/en/CF130UL](http://www.igus.de/en/CF130UL)

IGUS® CHAINFLEX® CF130.UL

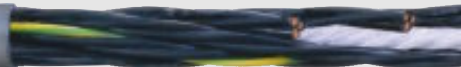

TIP!

Speed / acceleration $FL_G$	max. 20 [m/s] / max. 200 [m/s <sup>2</sup> ]
Speed / acceleration $FL_B$	max. 3 [m/s] / max. 6 [m/s <sup>2</sup> ]
Gliding speed / acceleration (maximum)	max. 10 [m/s] / max. 50 [m/s <sup>2</sup> ]
Material - permitted temperature °C	igumid G / -40° to +130° C
Flammability class, igumid G	VDE 0304 IIC UL94 HB

**Technical Data**



Details of material properties  
 ► page 1.38



► page 5.39



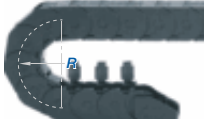
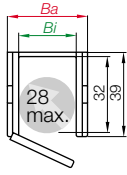

Serie F17 - snap-open along inner radius

Part No.	Bi [mm]	Ba [mm]	R [mm]	Bending Radii	Weight [kg/m]
F17.015.□.0	15	26	048		~ 0,52

The bending radii 063 075 100 125 are available upon request.  
 Delivery time: approx. 8-10 weeks after receipt of order!

Supplement part no. with required radius (R) Example: F17.015.048.0  
 0 = standard color, other colors ▶ page 1.39 · Pitch = 30,5 mm/link - Links/m = 33

Part No. structure

F17. 015. 048. 0



Serie F17 - Interior separation

Vert. Separator, slotted	
unassembled	R171
assembled	R172



Option 1: Vertical Separators

Vertical Separators are used if a vertical subdivision of the E-Chain® interior is required -  
 By standard Vertical Separators are assembled every other E-Chain® link  
 ● Standard subdivision with Vertical Separator, slotted R172,  
 for combinations with Full-Width Shelf 111.X

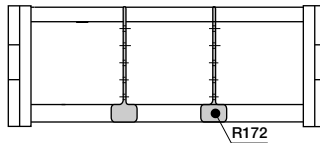

Option 2: Full-Width Shelves

For applications involving many thin cables with similar or identical diameters

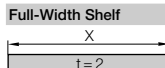
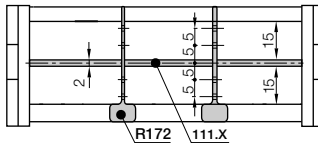

Width	Part No.	Part No.
X [mm]	unassembled	assembled
015	110.15	111.15



**Polymer - locking**

- One-piece mounting bracket
- Corrosion-resistant
- Available preassembled
- Inner and outer attachment possible
- Available with or without integrated strain relief tiwrap plates

Moving end with bore (outer link) 117...1P(Z)

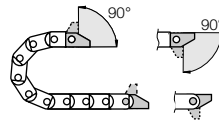

117...2P(Z) Fixed end with pin (inner link)

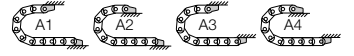

Possible installation conditions for assembled mounting brackets ▶ Order example "preassembled" below

117...1P(Z)

Moving end

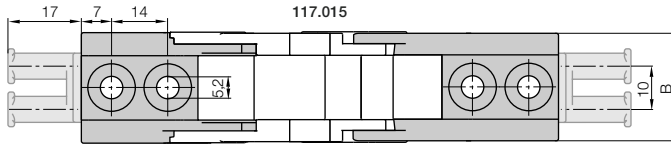

117...2P(Z)

Fixed end

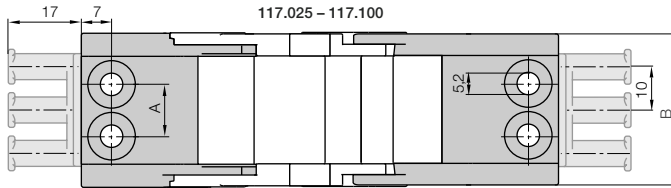

**Dimensions and order configurations**

Strain relief is possible on the moving end and/or the fixed end.

**Part No. structure**

117.	015.	12	PZ	A1
------	------	----	----	----

A... must be indicated on preassembled configurations

Full set with strain relief

Full set = 12

Width

Mounting brackets for selected chain type

Full set, for both ends:

117.015.12 PZ +tiwrap plate

Single-part order:

117.015.1 PZ +tiwrap plate

Mounting bracket with bore

117.015.2 PZ +tiwrap plate

Mounting bracket with pin

For E-chain®	Part No. full set with tiwrap plate	Part No. full set without tiwrap plate	Number of teeth	Dim. A [mm]	Dim. B [mm]
F17.015.	▶ 117.015.12 PZ	117.015.12 P	2	-	25,7

For the preassembled mode please add the index A1...A4 Example: 117.015.12 PZ A1

Phone +49- (0) 22 03-96 49-800  
Fax +49- (0) 22 03-96 49-222







25000.05

1.1

E2/000

SPB

Opening system from left or right    Large pin for longer unsupported length    Double stop dog    Lateral glide surfaces

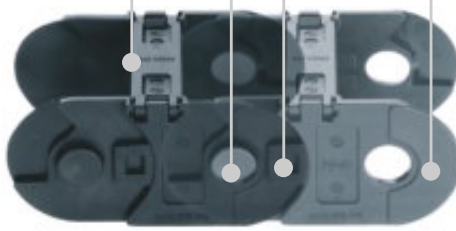

### E2/000 E-Chains® - the standard for System E2

- Open crossbar left or right quickly with screwdriver or by hand
- Opening mechanism accessible from above to allow access in confined spaces
- Lightning-fast closing by hand - Secure fit without additional locking devices
- Secure fit of interior separation even when E-Chain® is open
- Excellent mechanical stability, long life due to design and material
- You can find more technical data about the material, chemical resistance, temperatures ► [chapter design, from page 1.38](#)

#### Opening-principle



Snap-open along outer radius on left or right side



Snap-open along inner radius on left or right side

#### Dimensioning

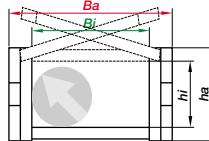

#### Bending radius

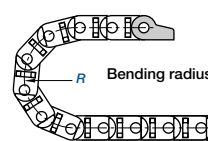

#### Part No. structure

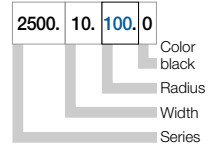

#### Selection table

Series	Inner height <i>hi</i> [mm]	Inner width <i>Bi</i> [mm]	Outer width <i>Ba</i> [mm]	Outer height <i>ha</i> [mm]	Bending radius <i>R</i> [mm]	Unsupported length max. [m]	Page
1400/1500	21	15 - 125	28,5 - 138,5	28	35 - 180	2,00	<b>5.84</b>
2400/2500	25	25 - 125	41,0 - 141,0	35	55 - 250	2,50	<b>5.94</b>
2600/2700	35	50 - 175	66,0 - 194,0	50	63 - 250	3,25	<b>5.106</b>
3400/3500	45	50 - 250	70,0 - 270,0	64	75 - 300	3,25	<b>5.118</b>
255	24	38 - 103	54,2 - 119,2	35	55 - 250	1,80	<b>5.130</b>

Material igumid ESD (upon request)    Rapid opening system    Double stop dog    Lateral glide surfaces

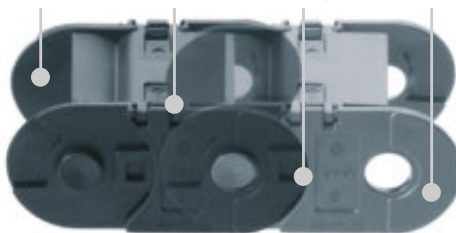

### Two-piece half- and fully enclosed E-Tube

- Enclosed E-Tube can be used in chip areas (also hot chips)
- New snap-open mechanism, snap-open on left or right
- Opening mechanism accessible from above - rapid opening of the E-Tube with a screwdriver or by hand
- Lightning-fast closing by hand - Secure fit without additional locking devices
- Secure fit of interior separation even when E-Tube is open
- You can find more technical data about the material, chemical resistance, temperatures ► [chapter design, from page 1.38](#)

#### Opening-principle



Snap-open along inner radius on left or right side (for all E-Tubes)

#### Dimensioning

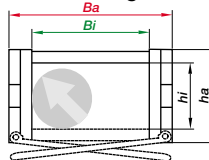

#### Bending radius

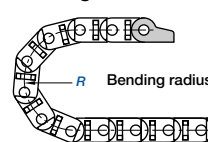

#### Part No. structure

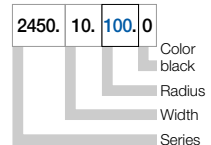

#### Selection table

Series	Inner height <i>hi</i> [mm]	Inner width <i>Bi</i> [mm]	Outer width <i>Ba</i> [mm]	Outer height <i>ha</i> [mm]	Bending radius <i>R</i> [mm]	Unsupported length max. [m]	Page
1450/1480	21	15 - 125	28,5 - 138,5	28	35 - 180	2,00	<b>5.84</b>
2450/2480	25	25 - 125	41,0 - 141,0	35	55 - 250	2,50	<b>5.84</b>
2650/2680	35	50 - 175	66,0 - 194,0	50	63 - 250	3,25	<b>5.106</b>
3450/3480	45	50 - 250	70,0 - 270,0	64	75 - 300	3,25	<b>5.118</b>

## Main characteristics at a first glance

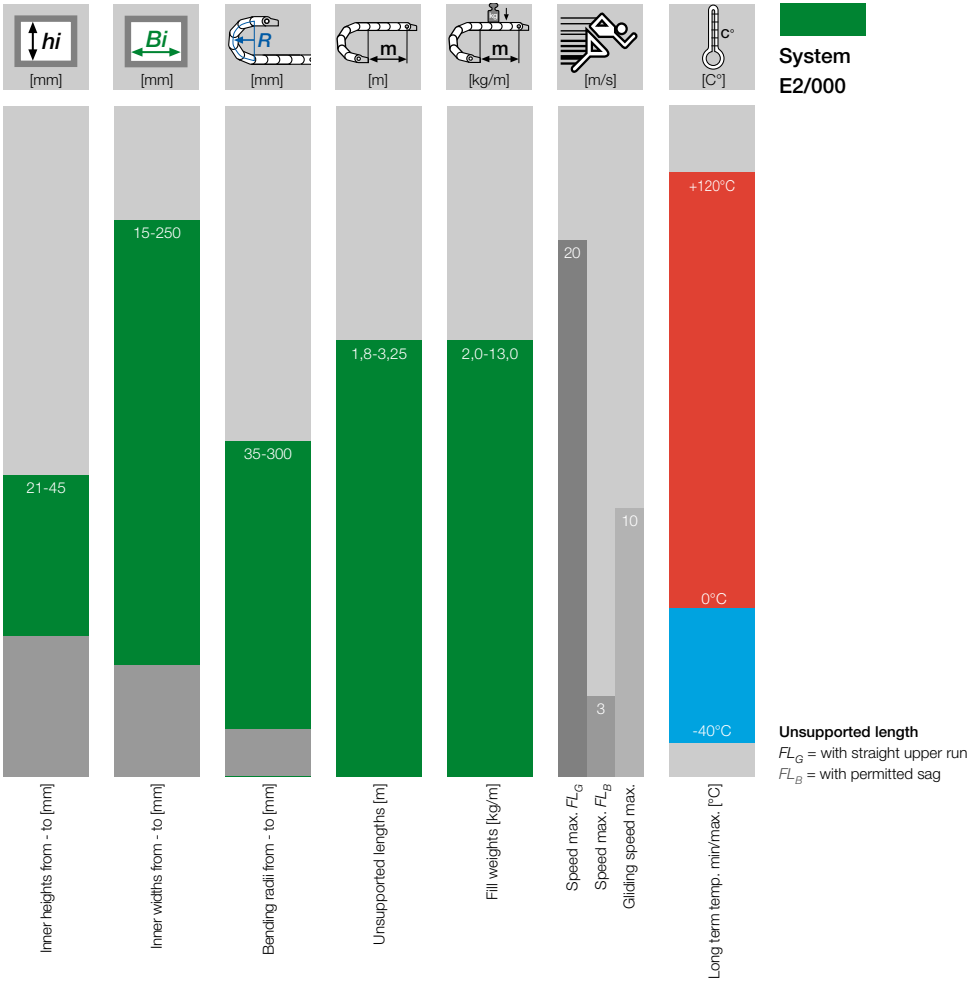

### Additional quality features - System E2/000

IPA Qualification Certificate Air Cleanless  
 Class ISO Class 3 (at  $v = 2$  m/s)

UL94-V2 classifications  
 upon request

ESD classification ISO class 5 ( $v = 1$  m/s) Series 2500.05.055  
 with standard material igumid G - Special equipment: Electrically  
 conductive ESD/ATEX version upon request

System E2/000 -  
 2-piece link-design

**E2/000: E-Chains® with a 2-piece link design** - The E2/000 Series is igus® fourth generation in this popular size range. All the experience went into this "New Millenium Series": easy and versatile assembly combined with ruggedness - high stability paired with quieter motion; long cable life parallel with many fixation options. The design is consistent within all E2/000 variations. It is the trusted program of machine builders around the world.

**Typical industries and applications**

- General machinery
- Material Handling
- Construction machinery
- Long travel applications in many industries
- Semicon
- ESD Atex versions certified
- Theatrical and Entertainment and Amusement parcs
- Vehicles
- And many more



Special snap-open mechanism, choice of snap-open on left or right. Hinged crossbar can be swiveled by more than 180° on both sides



977 igus® E-Chains® of the Series 2400 are used for a special stage equipment



Hanging application with Series 2400

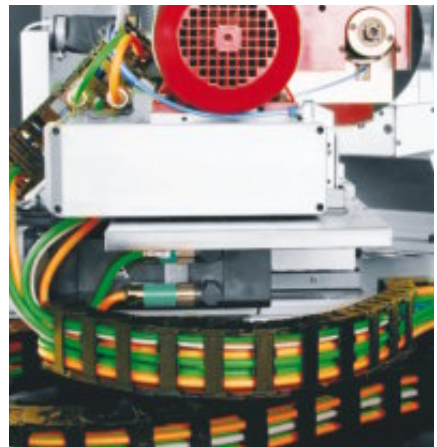

Side mounted application with Series 2500



**Assembling | E2/000**



1 Push and click



2 Snap in pin



3 Swivel crossbars



4 Push and snap



5 Snap mounting bracket into link



6 Snap tiewrap plate into bottom groove

**Separation | E2/000**



1 Lever crossbars open



2 Release side-link



3 Twist and pull apart

**Opening | Closing | E2/000 E-Tube**



1 Open: swivel lids



2 Close: push and snap



3 Half E-Tube: swivel crossbars



4 Lever



5 Remove lid





Price index



IPA Qualification Certificate Air  
Cleanless Class ISO Class 3  
(at v = 2 m/s) upon request



ESD classification:  
Electrically conductive ESD/ATEX  
version upon request



UL94 V2 classifications  
upon request



New snap-open mechanism, choice of snap-open on left or right. Hinged crossbar can be swiveled by more than 180° on both sides. Lightning-fast closing by hand. Secure fit without additional locking devices.



When to use the Series 1400/1450/1480/1500:

- If snap-open accessibility along inner or outer radius is required
- If integrated strain relief is required at the connection point
- If half E-Tube is required (Series 1450)
- If fully enclosed E-Tube is required (Series 1480)
- If long service life is required
- If easy installation is required
- Standard product with many accessories



When not to use it:

- If the application is very simple
  - ▶ Easy Chain®, Series E14, page 3.32

- ① Opening system for rapid opening, either from the right or the left
- ② Double stop dog for long unsupported length
- ③ Cross bars with high locking range
- ④ Series 1400 snap-open on both sides along inner radius
- ⑤ Series 1500 snap-open on both sides along outer radius
- ⑥ Series 1450 half E-Tube snap-open on both sides along inner radius
- ⑦ Series 1480 fully enclosed E-Tube snap-open on both sides along inner radius
- ⑧ Tried-and-tested mounting bracket
- ⑨ Modular interior separation
- ⑩ Easy assembly by optimized pin
- ⑪ Integrated strain relief possible
- ⑫ Also available as ESD version

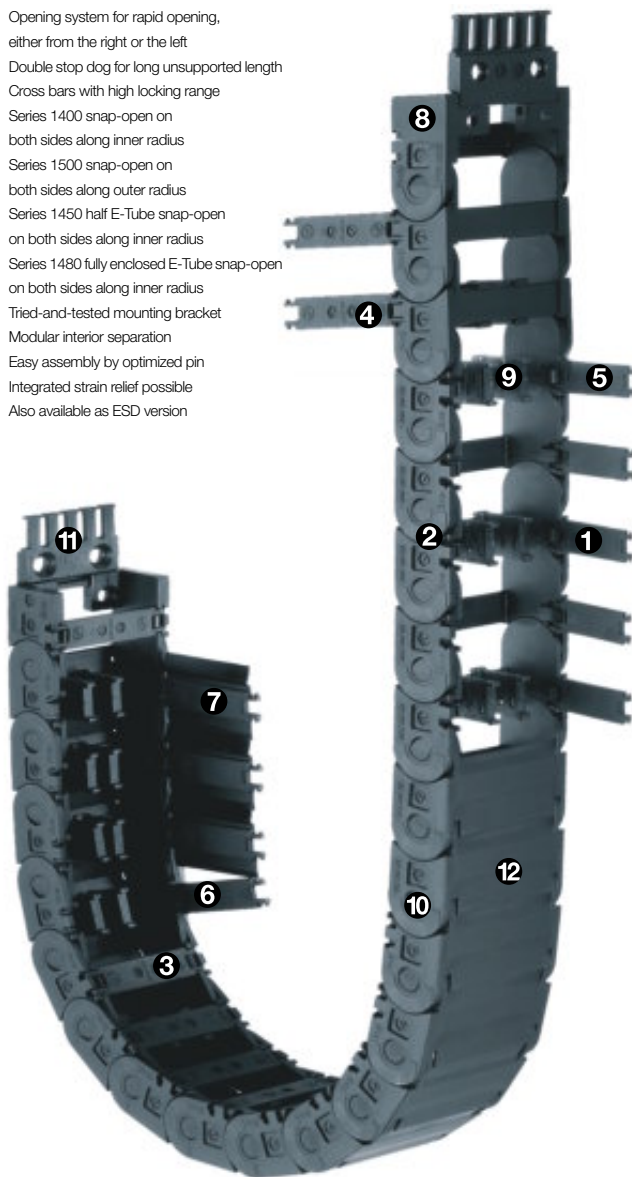

Order example complete E-Chain®

Please indicate chain-lengths or number of links Example: 3 m or 90 links

3 m 1400.038.100.0



E-Chain®

with 2 separators 14011 assembled every 2" link



Interior separation

1 set 15000.038.34PZB



Mounting bracket

### Unsupported length

$FL_G$  = with straight upper run

$FL_B$  = with permitted sag

Further information ► **Design, page 1.12**

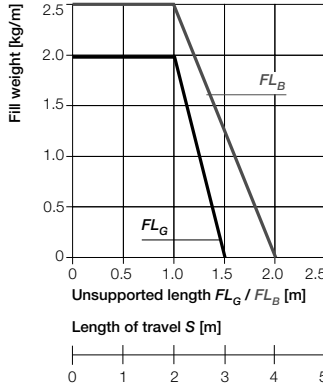
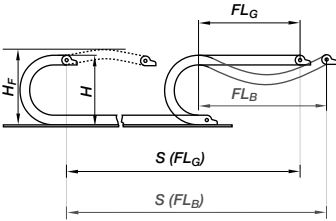

- $S$  = Length of travel
  - $R$  = Bending radius
  - $H$  = Nominal clearance height
  - $H_f$  = Required clearance height
  - $H_{in}$  = Trough inner height
  - $D$  = Overlength E-Chain\* radius in final position
  - $K = \pi \cdot R + \text{"safety"}$
  - $D_2$  = Overlength - long travels, gliding
  - $K_2$  = \*Further add-on
  - $H_2$  = \*Mounting height
- \*if the mounting bracket location is set lower

#### Other installation methods

- Vertical, hanging  $\leq 20$  m
- Vertical, standing  $\leq 2$  m
- Side mounted, un supp.  $\leq 0,7$  m
- Rotary requires further calculation
- Unsupported length of upper run = upon request

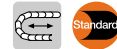

### Short travels - unsupported

Unsupported E-Chains\* feature positive camber over short travels. This must be accounted for when specifying the clearance height  $H_f$ . Please consult igus\* if space is particularly restricted.

The required clearance height:  
 $H_f = H + 25$  mm  
(with 0,5 kg/m fill weight)

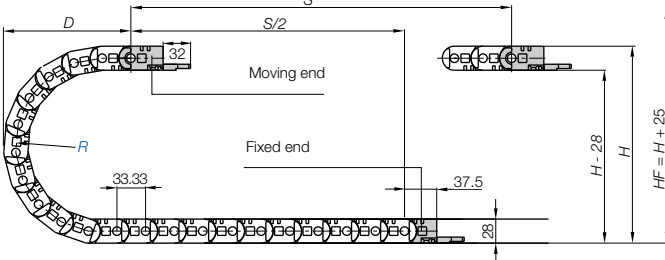

Pitch = 33,3 mm/link    Links/m = 30 (1000 mm)    Chain length =  $S/2 + K$

R	035*	038*	048*	075	100	125	145	180
H	98	104	124	178	228	278	318	388
D	85	90	100	125	150	175	195	230
K	180	190	220	305	385	460	525	635
$D_2^{*25}$	-	-	-	-	340	495	540	690
$K_2$	-	-	-	-	600	800	940	1170
$H_2$	-	-	-	-	100	100	100	100

\*for Series 1450/1480 upon request

### Long travel lengths from 10 m to max. 75 m    Chain length = $S/2 + K_2$

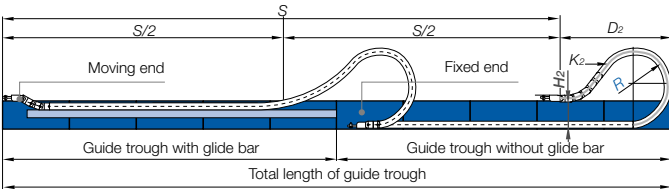

In case of travels between 4 and 10 m we recommend a longer unsupported length.



### Gliding, long travel applications (max. 75 m)

In this case the E-Chain\* upper run will be introduced in a guide trough on the lower run. We recommend to realize the engineering of such a plant by our technicians.

Speed / acceleration $FL_G$	max. 20 [m/s] / max. 200 [m/s <sup>2</sup> ]
Speed / acceleration $FL_B$	max. 3 [m/s] / max. 6 [m/s <sup>2</sup> ]
Gliding speed / acceleration (maximum)	max. 10 [m/s] / max. 50 [m/s <sup>2</sup> ]
Material - permitted temperature °C	igumid G / -40° up to +130° C
Flammability class, igumid G	VDE 0304 IIC UL94 HB

### Technical Data



Details of material properties  
► page 1.38



E2/000 medium  
Inner height: 21 mm

Phone +49- (0) 22 03-96 49-800  
Fax +49- (0) 22 03-96 49-222



► page 5.83

igus® E-ChainSystems®

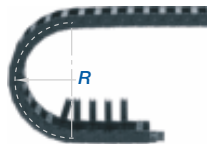
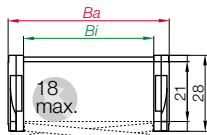

Part No. structure

1400.015.035.0



**Series 1400 - E-Chain® - snap-open along inner radius**

Part No.	Bi [mm]	Ba [mm]	R [mm]	Bending radii								Weight [kg/m]
1400.015.	15	28,5	035	038	048	075	100	125	145	180	~ 0,46	
1400.020.	20	33,5	035	038	048	075	100	125	145	180	~ 0,47	
1400.025.	25	38,5	035	038	048	075	100	125	145	180	~ 0,49	
1400.038.	38	51,5	035	038	048	075	100	125	145	180	~ 0,53	
1400.050.	50	63,5	035	038	048	075	100	125	145	180	~ 0,56	
1400.068.	68	81,5	035	038	048	075	100	125	145	180	~ 0,63	
1400.080.	80	93,5	035	038	048	075	100	125	145	180	~ 0,67	
1400.100.	100	113,5	035	038	048	075	100	125	145	180	~ 0,74	
1400.125.	125	138,5	035	038	048	075	100	125	145	180	~ 0,83	

Supplement Part No. with required radius. Example: 1400.015.035.0

0 = standard color, other colors ▶ page 1.39 · Pitch = 33,3 mm/link - Links/m = 30



Please note: For using this series for long travels (gliding), please consult with igus® first. For long travels, igus® specifies E-Chains® that snap open on the outer radius.

Phone +49- (0) 22 03-96 49-800  
Fax +49- (0) 22 03-96 49-222

igus® GmbH  
51147 Cologne

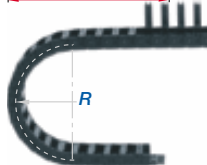
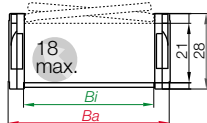

Part No. structure

1500.015.075.0



**Series 1500 - E-Chain® - snap-open along outer radius - Standard!**

Part No.	Bi [mm]	Ba [mm]	R [mm]	Bending radii								Weight [kg/m]
1500.015.	15	28,5	035	038	048	075	100	125	145	180	~ 0,46	
1500.020.	20	33,5	035	038	048	075	100	125	145	180	~ 0,47	
1500.025.	25	38,5	035	038	048	075	100	125	145	180	~ 0,49	
1500.038.	38	51,5	035	038	048	075	100	125	145	180	~ 0,53	
1500.050.	50	63,5	035	038	048	075	100	125	145	180	~ 0,56	
1500.068.	68	81,5	035	038	048	075	100	125	145	180	~ 0,63	
1500.080.	80	93,5	035	038	048	075	100	125	145	180	~ 0,67	
1500.100.	100	113,5	035	038	048	075	100	125	145	180	~ 0,74	
1500.125.	125	138,5	035	038	048	075	100	125	145	180	~ 0,83	

The width **Bi 20** is available upon request. Time of delivery approx. 6-8 weeks after order.

Supplement Part No. with required radius. Example: 1500.015.035.0

0 = standard color, other colors ▶ page 1.39 · Pitch = 33,3 mm/link - Links/m = 30



Internet: [www.igus.de](http://www.igus.de)  
E-mail: [info@igus.de](mailto:info@igus.de)

**Series 1450 - half E-Tube - snap-open along inner radius**

Part No.	<i>B<sub>i</sub></i> [mm]	<i>B<sub>a</sub></i> [mm]	<i>R</i> [mm]	Bending radii	Weight [kg/m]
1450.015.□.0	15	28,5	075	100 125 145 180	≈ 0,48
1450.025.□.0	25	38,5	075	100 125 145 180	≈ 0,57
1450.038.□.0	38	51,5	075	100 125 145 180	≈ 0,59
1450.050.□.0	50	63,5	075	100 125 145 180	≈ 0,65
1450.068.□.0	68	81,5	075	100 125 145 180	≈ 0,74
1450.080.□.0	80	93,5	075	100 125 145 180	≈ 0,80
1450.100.□.0	100	113,5	075	100 125 145 180	≈ 0,90
1450.125.□.0	125	138,5	075	100 125 145 180	≈ 0,103

The bending radii **035** **038** **048** are available upon request. Delivery time: approx. 6-8 weeks after receipt of order!

Supplement Part No. with required radius. Example: 1450.015.**075**.0

0 = standard color, other colors ▶ page 1.39 · Pitch = 33,3 mm/link - Links/m = 30



Please note: For using this series for long travels (gliding), please consult with igus® first. For long travels, igus® specifies E-Chains® that snap open on the outer radius.

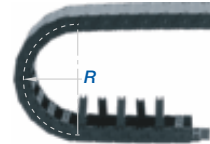
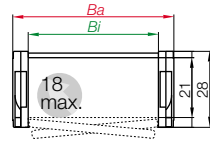

Part No. structure

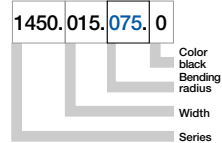

E2/000 medium  
Inner height: 21 mm

**Series 1480 - E-Tube - snap-open along inner radius**

Part No.	<i>B<sub>i</sub></i> [mm]	<i>B<sub>a</sub></i> [mm]	<i>R</i> [mm]	Bending radii	Weight [kg/m]
1480.015.□.0	15	28,5	075	100 125 145 180	≈ 0,48
1480.025.□.0	25	38,5	075	100 125 145 180	≈ 0,54
1480.038.□.0	38	51,5	075	100 125 145 180	≈ 0,61
1480.050.□.0	50	63,5	075	100 125 145 180	≈ 0,67
1480.068.□.0	68	81,5	075	100 125 145 180	≈ 0,77
1480.080.□.0	80	93,5	075	100 125 145 180	≈ 0,84
1480.100.□.0	100	113,5	075	100 125 145 180	≈ 0,95
1480.125.□.0	125	138,5	075	100 125 145 180	≈ 0,108

The width *B<sub>i</sub>* 15 / 25 / 68 / 80 / 100 / 125 is available upon request. Time of delivery approx. 6-8 weeks after order.

The bending radii **035** **038** **048** are available upon request. Delivery time: approx. 6-8 weeks after receipt of order!

Supplement Part No. with required radius. Example: 1480.038.**075**.0

0 = standard color, other colors ▶ page 1.39 · Pitch = 33,3 mm/link - Links/m = 30



Please note: For using this series for long travels (gliding), please consult with igus® first. For long travels, igus® specifies E-Chains® that snap open on the outer radius.

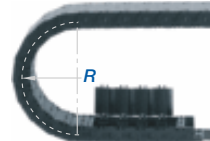
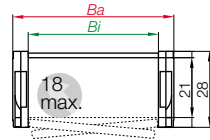

Part No. structure

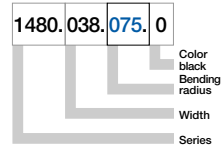

Phone +49- (0) 22 03-96 49-800  
Fax +49- (0) 22 03-96 49-222

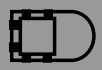

▶ page 5.83

Vert. Separator, slotted	
unassembled	14001
assembled	14011



### Option 1: Vertical Separators for E-Chains® Series 1400 · 1500

Vertical Separators are used if a vertical subdivision of the E-Chain® interior is required -

By standard Vertical Separators are assembled every other E-Chain® link

- Standard subdivision with Vertical Separator, slotted 14011, for combinations with Full-Width Shelf 111.X

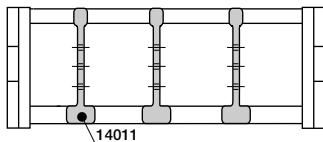

Vert. Separator, slotted	
unassembled	14501
assembled	14511



### Option 2: Vertical Separators for E-Tubes Series 1450 · 1480

Vertical Separators are used if a vertical subdivision of the half E-Tube (Series 1450) and the fully enclosed E-Tube (Series 1480) interior is required -

By standard Vertical Separators are assembled every other E-Chain® link

- Standard subdivision with Vertical Separator, slotted 14511, for combinations with Full-Width Shelf 111.X

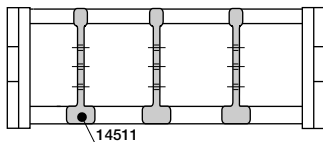

### Option 3: Full-Width Shelves for E-Chains® Series 1400 · 1500 and E-Tubes Series 1450 · 1480

For applications involving many cables with similar or identical diameters

- Full-Width Shelf 111.X can be combined with Vertical Separator, slotted 14011 (E-Chain®) and Vertical Separator, slotted 14511 (E-Tube/half E-Tube)

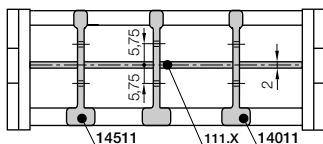

Full-Width Shelf	
X	
t = 2	

Width X [mm]	Part No. unassembled	Part No. assembled
015	110.15	111.15
020	110.20	111.20
025	110.25	111.25
038	110.38	111.38
050	110.50	111.50

Width X [mm]	Part No. unassembled	Part No. assembled
068	110.68	111.68
080	110.80	111.80
100	110.100	111.100
125	110.125	111.125

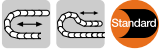

**The Standard - one-piece mounting brackets - pivoting**

- Recommended for unsupported and gliding applications
- Well suited for tight installation conditions
- Integrated multited strain relief
- Easy to assemble
- Various mounting positions

Moving end with bore  
(outer link) 14...3PZ

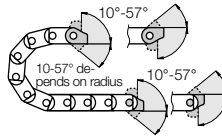

14...4PZ Fixed end  
with pin (inner link)

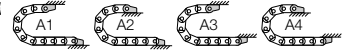

Possible installation conditions for assembled mounting brackets ▶ Order example "preassembled" below

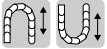

**One-piece mounting brackets - locking**

- Recommended for unsupported and gliding applications
- Furthermore:
- At very high speed and/or acceleration
  - If space is limited for height (the  $H_F$  measurement)
  - Various mounting positions

Moving end with bore  
(outer link) 14...1PZ

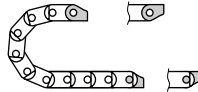

14...2PZ Fixed end  
with pin (inner link)



Possible installation conditions for assembled mounting brackets ▶ Order example "preassembled" below

14...3PZ Standard! (pivoting)  
14...1PZ (locking)

Moving end

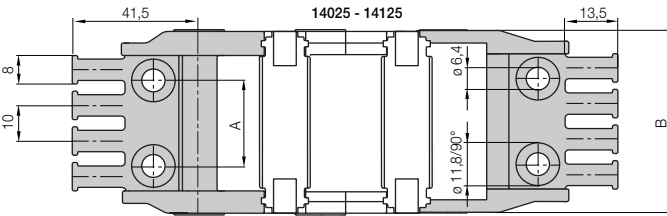
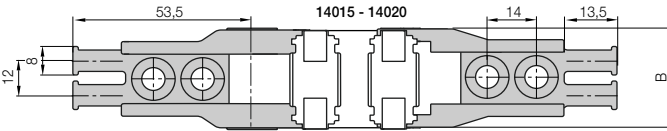

Standard! (pivoting) 14...4PZ  
(locking) 14...2PZ

Fixed end

For E-Chain®:	Part No. full set with tiwrap plate	Dim.A [mm]	Dim.B [mm]	Number of teeth
1400 - 1500.015 ▶	14015. [ ] PZ	-	28,5	2
1400 - 1500.020 ▶	14020. [ ] PZ	-	33,5	2
1400 - 1500.025 ▶	14025. [ ] PZ	13	38,5	2
1400 - 1500.038 ▶	14038. [ ] PZ	24	51,5	4
1400 - 1500.050 ▶	14050. [ ] PZ	36	63,5	6
1400 - 1500.068 ▶	14068. [ ] PZ	54	81,5	7
1400 - 1500.080 ▶	14080. [ ] PZ	66	93,5	8
1400 - 1500.100 ▶	14100. [ ] PZ	86	113,5	10
1400 - 1500.125 ▶	14125. [ ] PZ	111	138,5	13

Please add the Part No. with the requested index - 34 for the pivoting configuration

e.g. 14015. [34] PZ or 12 for the locking configuration e.g. 14015. [12] PZ

For the preassembled mode please add the index [A1] ... [A4] e.g. 14015. [34] PZ [A1]

**Dimensions and order configurations**

Strain relief is possible on the moving end and/or the fixed end.

Part No. structure (pivoting)

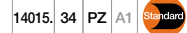

A... must be indicated on preassembled configurations  
With assembled strain relief tiwrap plates  
Full set pivoting = 34  
Mounting brackets for selected chain type

Full set, for both ends:

[14015.34] PZ +tiwrap plate

Single-part order:

[14015.3] PZ +tiwrap plate

Mounting bracket with bore

[14015.4] PZ +tiwrap plate

Mounting bracket with pin

Part No. structure (locking)

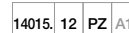

A... must be indicated on preassembled configurations  
With assembled strain relief tiwrap plates  
Full set pivoting = 12  
Mounting brackets for selected chain type

Full set, for both ends:

[14015.12] PZ +tiwrap plate

Single-part order:

[14015.1] PZ +tiwrap plate

Mounting bracket with bore

[14015.2] PZ +tiwrap plate

Mounting bracket with pin



▶ page 5.83



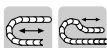

### Mounting bracket - polymer

- Recommended for unsupported and gliding applications
- Well suited for tight installation conditions
- Strain relief with detachable tiwrap plates
- Variable traverse angle for flexible assembly
- The twistability of the E-Chain® and the option to assemble the mounting brackets on the fixed end and/or the moving end, enable various installation options

Moving end with bore  
(outer link) 15000...3PZ(B)

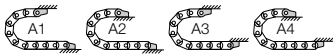
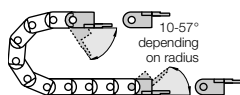

Possible installation conditions for assembled mounting brackets ▶ Order example "preassembled" below

15000...4PZ(B) Fixed end  
with pin (inner link)

### Dimensions and order configurations

Strain relief is possible on the moving end and/or the fixed end.

15000...3PZ(B)  
Moving end

15000...4PZ(B)  
Fixed end

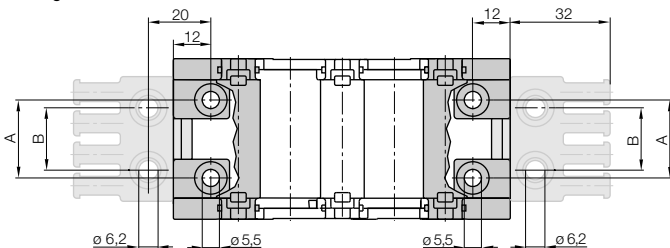

#### Part No. structure

15000.038.34.PZB.A1

A... must be indicated on preassembled configurations

With assembled strain relief tiwrap plates

Full set pivoting = 34

Width

Mounting brackets for selected chain type

#### Full set, for both ends:

15000.038.34.PZB +tiwrap plate

#### Single-part order:

15000.038.3.PZB +tiwrap plate

Mounting bracket with bore

15000.038.4.PZB +tiwrap plate

Mounting bracket with pin

For E-Chain®	Part No. full set with tiwrap plate	Part No. full set without tiwrap plate	Dim. A [mm]	Dim. B [mm]
1400 – 1500.015 ▶	–	–	–	–
1400 – 1500.020 ▶	–	–	–	–
1400 – 1500.025 ▶	15000.025.34.PZB	15000.025.34.PZ	12	15
1400 – 1500.038 ▶	15000.038.34.PZB	15000.038.34.PZ	25	20
1400 – 1500.050 ▶	15000.050.34.PZB	15000.050.34.PZ	37	30
1400 – 1500.068 ▶	15000.068.34.PZB	15000.068.34.PZ	55	40
1400 – 1500.080 ▶	15000.080.34.PZB	15000.080.34.PZ	67	60
1400 – 1500.100 ▶	15000.100.34.PZB	15000.100.34.PZ	87	80
1400 – 1500.125 ▶	15000.125.34.PZB*	15000.125.34.PZ	113	105

For the preassembled mode please add the index A1...A4 e.g. 15000.038.34.PZB A1

\*Tie wrap plate (consists of 2 x 2050.ZB) does not snap on but needs to be bolted down separately

Phone +49- (0) 22 03-96 49-800  
Fax +49- (0) 22 03-96 49-222

igus® GmbH  
51147 Cologne

Internet: www.igus.de  
E-mail: info@igus.de



### Steel mounting bracket - locking

- Locked connections
- One part for all chain widths
- Electrically conductive
- Bolted connection outside of chain cross-section possible

Moving end with bore  
(outer link) 14000...1

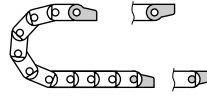

14000...2 Fixed end  
with pin (inner link)

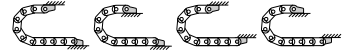

Possible installation conditions -  
Further installation angles ► installation sketch

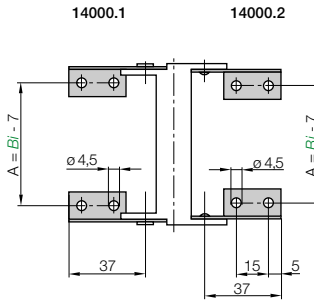
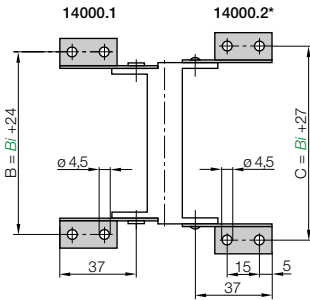

### Dimensions and order configurations

\*pivoting with no stop, (360°).  
Screw-on area of the mounting brackets can be on the interior or exterior.

For E-Chain*	Part No. full set	Dim. A [mm]	Dim. B [mm]	Dim. C [mm]
1400 - 1500.015 ►	14000. 12	8	39	42
1400 - 1500.020 ►	14000. 12	13	44	47
1400 - 1500.025 ►	14000. 12	18	49	52
1400 - 1500.038 ►	14000. 12	31	62	65
1400 - 1500.050 ►	14000. 12	43	74	77
1400 - 1500.068 ►	14000. 12	61	92	95
1400 - 1500.080 ►	14000. 12	73	104	107
1400 - 1500.100 ►	14000. 12	93	124	127
1400 - 1500.125 ►	14000. 12	118	149	152

14000. 12 Full set, 4 parts  
2 with pin / 2 with bore

Single-part order:

14000. 1 Mounting bracket with bore, 1 part left / right

14000. 2 Mounting bracket with pin, 1 part left / right

Phone +49- (0) 22 03-96 49-800  
Fax +49- (0) 22 03-96 49-222



igus® E-ChainSystems®

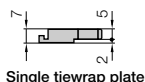

Single tie-wrap plate

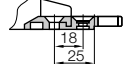

Shown assembled

### Tie-wrap plate as individual part

As individual component screwed on KMA. Can be plugged in the mounting brackets. **Details ▶ chapter 10**

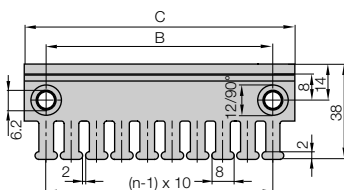

Tie-wrap plate	No. of teeth <i>n</i>	Dim. C [mm]	Dim. B [mm]
2020.ZB	3	30	15
2030.ZB	4	40	20
2040.ZB	5	50	30
2050.ZB	6	60	40
2070.ZB	8	80	60
2090.ZB = (2030.ZB + 2040.ZB)	9	90	–
2100.ZB	10	100	80
2125.ZB = (2050.ZB + 2050.ZB)	12	120	–

Phone +49- (0) 22 03-96 49-800  
Fax +49- (0) 22 03-96 49-222



### Cable tiewraps as individual part

Cable tiewraps (100-piece bag)	Width x length	max. Ø	Tensile strength
CFB.001	4,8 x 150 mm	36 mm	222 N



### Strain relief for steel mounting brackets

Clip-on connection is not possible with steel mounting brackets. In this case, the tie-wrap plates must be bolted directly into separate bore holes in front of the mounting bracket. Alternatively the tie-wrap plates 20XX.ZB can be also used here. **Details ▶ chapter 10**

igus® GmbH  
51147 Cologne



Other strain relief elements - optional ▶ chapter 10

Internet: [www.igus.de](http://www.igus.de)  
E-mail: [info@igus.de](mailto:info@igus.de)

## Braiding in bundles for long travels - Chainflex® CF5

oil-proof in accordance with VDE, flame-retardant  
Further information: [www.igus.de/en/CF5](http://www.igus.de/en/CF5)

TIPP!

IGUS® CHAINFLEX® CF5



● ● ● Price index



IPA Qualification Certificate Air  
Cleanless Class ISO Class 3  
(at v = 2 m/s)



ESD classification:  
Electrically conductive ESD/ATEX  
version upon request



UL94 V2 classifications  
upon request



New snap-open mechanism, choice of snap-open on left or right. Hinged crossbar can be swiveled by more than 180° on both sides. Lightning-fast closing by hand. Secure fit without additional locking devices.



When to use the Series 2400/2450/2480/2500:

- Snap-open accessibility along both radii
- If integrated strain relief is required at the connection point
- Modular interior separation
- If long service life is required
- If easy installation is required
- If half E-Tube is required (Series 2450)
- If fully enclosed E-Tube is required (Series 2480)



When not to use it:

- If maximum stability is required
  - ▶ System E4, Series 210, page 7.12
- If the application is very simple
  - ▶ Easy Chain®, Series E200, page 3.36
- E-Tubes with small bending radii 060, 075
  - ▶ System E2 E-Tubes, Series R48, page 6.26

- ① Double stop dog for long unsupported length
- ② Opening system for rapid opening, either from the right or the left
- ③ Cross bars with high locking range
- ④ Lateral glide surfaces for side-mounted operation
- ⑤ Tried-and-tested mounting bracket
- ⑥ Integrated strain relief possible
- ⑦ Series 2400 and 2450 snap-open along inner radius
- ⑧ Series 2450 half E-Tube snap-open along inner radius, either from the right or the left
- ⑨ Fully enclosed E-Tube Series 2480 snap-open along inner radius
- ⑩ Modular interior separation
- ⑪ Easy assembly by optimized pin
- ⑫ Also available as ESD version
- ⑬ **Strain relief separator** - Separator with integrated strain relief ▶ page 5.104

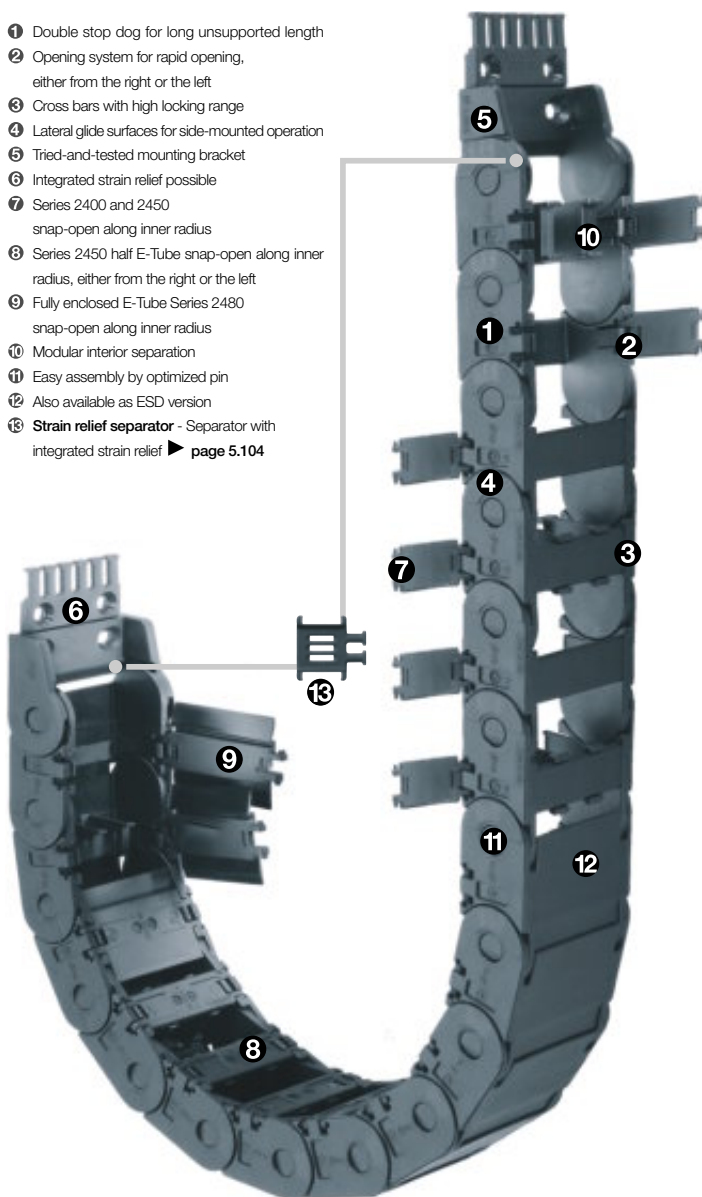

Order example complete E-Chain®

Please indicate chain-lengths or number of links Example: 3 m or 66 links

3 m 2500.10.100.0



E-Chain®

with 2 separators 211 assembled every 2<sup>nd</sup> link



Interior separation

1 set 2100.34PZB+



Mounting bracket

### Unsupported length

$FL_G$  = with straight upper run

$FL_B$  = with permitted sag

Further information ► **Design, page 1.12**

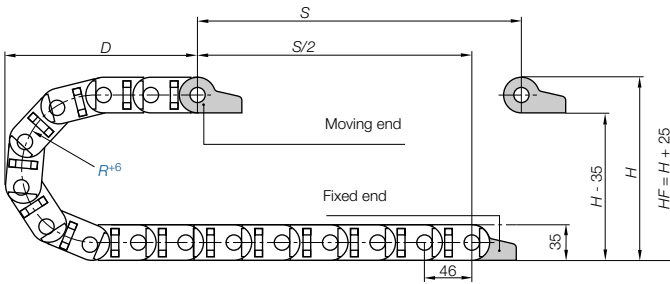
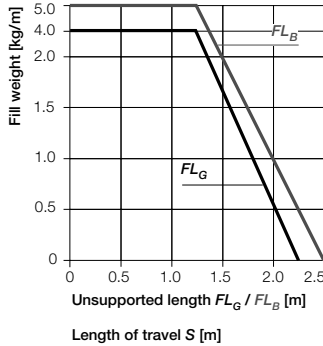
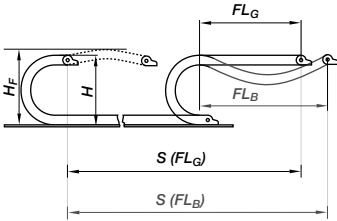

Pitch = 46 mm/link    Links/m = 22 (1012 mm)    Chain length =  $S/2 + K$

R	055°	075°	100	125	150	175	200	225	250
H	145	185	235	285	335	385	435	485	535
D	125	150	170	195	220	245	270	295	320
K	276	346	414	496	578	660	742	814	920
$D_2^{+25}$	-	-	380	440	590	755	950	1040	1130
$K_2$	-	-	644	736	1012	1242	1472	1610	1794
$H_2$	-	-	100	100	100	100	100	100	100

\*for Series 2450/2480 upon request

- S = Length of travel
  - R = Bending radius
  - H = Nominal clearance height
  - $H_F$  = Required clearance height
  - $H_{in}$  = Trough inner height
  - D = Overlength E-Chain® radius in final position
  - $K = \pi \cdot R + \text{"safety"}$
  - $D_2$  = Overlength - long travels, gliding
  - $K_2$  = \*Further add-on
  - $H_2$  = \*Mounting height
- \*if the mounting bracket location is set lower

### Other installation methods

- Vertical, hanging  $\leq 40$  m
- Vertical, standing  $\leq 3$  m
- Side mounted, un supp.  $\leq 1$  m
- Rotary requires further calculation
- Unsupported length of upper run = upon request

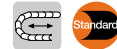

### Short travels - unsupported

Unsupported E-Chains® feature positive camber over short travels. This must be accounted for when specifying the clearance height  $H_F$ . Please consult igus® if space is particularly restricted.

The required clearance height:  
 $H_F = H + 25$  mm  
(with 1,5 kg/m fill weight)

### Long travel lengths from 10 m to max. 100 m    Chain length = $S/2 + K_2$

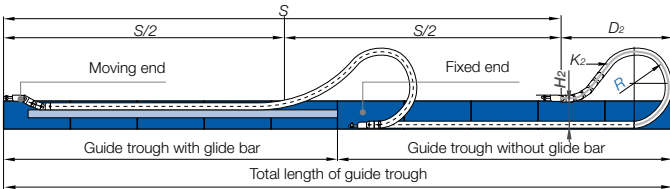

In case of travels between 4 and 10 m we recommend a longer unsupported length.



### Gliding, long travel applications (max. 100 m)

In this case the E-Chain® upper run will be introduced in a guide trough on the lower run. We recommend to realize the engineering of such a plant by our technicians.

Speed / acceleration $FL_G$	max. 20 [m/s] / max. 200 [m/s²]
Speed / acceleration $FL_B$	max. 3 [m/s] / max. 6 [m/s²]
Gliding speed / acceleration (maximum)	max. 10 [m/s] / max. 50 [m/s²]
Material - permitted temperature °C	igumid G / -40° up to +130° C
Flammability class, igumid G	VDE 0304 IIC UL94 HB

### Technical Data



Details of material properties  
► page 1.38

25

E2/000 medium  
Inner height: 25 mm

Phone +49- (0) 22 03-96 49-800  
Fax +49- (0) 22 03-96 49-222



► page 5.83

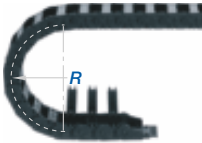
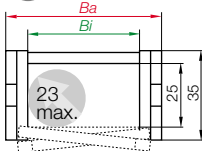

Part No. structure

2400. 02. 055. 0



**Series 2400 E-Chain® - snap-open along inner radius**

Part No.	Bi [mm]	Ba [mm]	R [mm]	Bending radii										Weight [kg/m]
2400.02.□.0	25	41	055	075	100	125	150	175	200	225	250	≈ 0,77		
2400.03.□.0	38	54	055	075	100	125	150	175	200	225	250	≈ 0,83		
2400.05.□.0	57	73	055	075	100	125	150	175	200	225	250	≈ 0,91		
2400.07.□.0	77	93	055	075	100	125	150	175	200	225	250	≈ 1,01		
2400.09.□.0	89	105	055	075	100	125	150	175	200	225	250	≈ 1,08		
2400.10.□.0	103	119	055	075	100	125	150	175	200	225	250	≈ 1,15		
2400.12.□.0	125	141	055	075	100	125	150	175	200	225	250	≈ 1,22		

Supplement Part No. with required radius. Example: 2400.02.[055].0

0 = standard color, other colors ▶ page 1.39 · Pitch = 46 mm/link - Links/m = 22

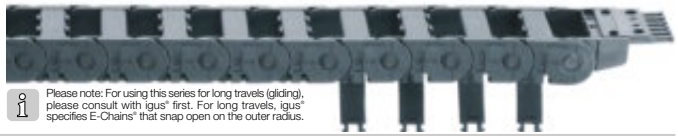

Please note: For using this series for long travels (gliding), please consult with igus® first. For long travels, igus® specifies E-Chains® that snap open on the outer radius.

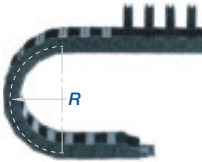
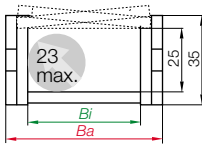

Part No. structure

2500. 02. 055. 0



**Series 2500 - E-Chain® - snap-open along outer radius - Standard!**

Part No.	Bi [mm]	Ba [mm]	R [mm]	Bending radii										Weight [kg/m]
2500.02.□.0	25	41	055	075	100	125	150	175	200	225	250	≈ 0,77		
2500.03.□.0	38	54	055	075	100	125	150	175	200	225	250	≈ 0,83		
2500.05.□.0	57	73	055	075	100	125	150	175	200	225	250	≈ 0,91		
2500.07.□.0	77	93	055	075	100	125	150	175	200	225	250	≈ 1,01		
2500.09.□.0	89	105	055	075	100	125	150	175	200	225	250	≈ 1,08		
2500.10.□.0	103	119	055	075	100	125	150	175	200	225	250	≈ 1,15		
2500.12.□.0	125	141	055	075	100	125	150	175	200	225	250	≈ 1,22		

Supplement Part No. with required radius. Example: 2500.02.[055].0

0 = standard color, other colors ▶ page 1.39 · Pitch = 46 mm/link - Links/m = 22





**Series 2450 - half E-Tube - snap-open along inner radius**

Part No.	<i>B<sub>i</sub></i> [mm]	<i>B<sub>a</sub></i> [mm]	<i>R</i> [mm]	Bending radii	Weight [kg/m]
2450.02.□.0	25	41	100	125 150 175 200 225 250	≈ 0,80
2450.03.□.0	38	54	100	125 150 175 200 225 250	≈ 0,88
2450.05.□.0	57	73	100	125 150 175 200 225 250	≈ 0,99
2450.07.□.0	77	93	100	125 150 175 200 225 250	≈ 1,12
2450.09.□.0	89	105	100	125 150 175 200 225 250	≈ 1,20
2450.10.□.0	103	119	100	125 150 175 200 225 250	≈ 1,27
2450.12.□.0	125	141	100	125 150 175 200 225 250	≈ 1,35

The width *B<sub>i</sub>* 125 is available upon request. Time of delivery approx. 6-8 weeks after order.  
 The bending radii **055** **075** are available upon request. Delivery time: approx. 6-8 weeks after receipt of order  
 Supplement Part No. with required radius. Example: 2450.02.**100**.0  
 0 = standard color, other colors ▶ page 1.39 · Pitch = 46 mm/link - Links/m = 22

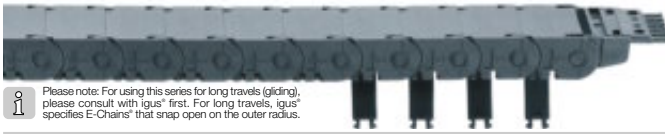

Please note: For using this series for long travels (gliding), please consult with igus® first. For long travels, igus® specifies E-Chains® that snap open on the outer radius.

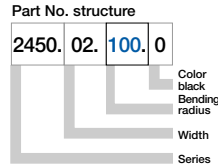
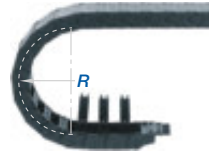
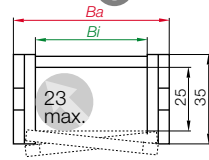

**Series 2480 - E-Tube - snap-open along inner radius**

Part No.	<i>B<sub>i</sub></i> [mm]	<i>B<sub>a</sub></i> [mm]	<i>R</i> [mm]	Bending radii	Weight [kg/m]
2480.02.□.0	25	41	100	125 150 175 200 225 250	≈ 0,82
2480.03.□.0	38	54	100	125 150 175 200 225 250	≈ 0,92
2480.05.□.0	57	73	100	125 150 175 200 225 250	≈ 1,03
2480.07.□.0	77	93	100	125 150 175 200 225 250	≈ 1,17
2480.09.□.0	89	105	100	125 150 175 200 225 250	≈ 1,26
2480.10.□.0	103	119	100	125 150 175 200 225 250	≈ 1,34
2480.12.□.0	125	141	100	125 150 175 200 225 250	≈ 1,43

The width *B<sub>i</sub>* 125 is available upon request. Time of delivery approx. 6-8 weeks after order.  
 The bending radii **055** **075** are available upon request. Delivery time: approx. 6-8 weeks after receipt of order  
 Supplement Part No. with required radius. Example: 2480.03.**100**.0  
 0 = standard color, other colors ▶ page 1.39 · Pitch = 46 mm/link - Links/m = 22



Please note: For using this series for long travels (gliding), please consult with igus® first. For long travels, igus® specifies E-Chains® that snap open on the outer radius.

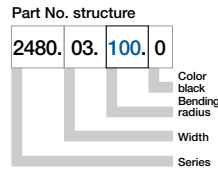
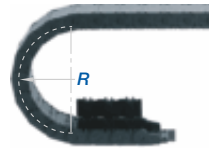
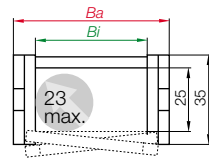

For smaller bending radii we recommend the fully closed E-Tubes, Series R48 ▶ page 6.26

E2/000 medium  
Inner height: 25 mm

Phone +49- (0) 22 03-96 49-800  
Fax +49- (0) 22 03-96 49-222



▶ page 5.83



Vertical Separator	
unassembled	201
assembled	211



Vertical Separator*	
unassembled	201.28
assembled	211.28



Spacer*	
unassembled	205.09
assembled	215.09



Strain Relief Separator	
unassembled	2020.Z
assembled	2120.Z



\*For side-mounted applications

### Option 1: Vertical Separators and Spacer for E-Chains®

Vertical Separators are used if a vertical subdivision of the E-Chain® interior is required -

By standard Vertical Separators are assembled every other E-Chain® link

- **Standard:** subdivision (Series 2400/Series 2500) with Vertical Separator 211
- If a broad distance shall be kept between the separators or they have to be fixed in their position, e.g. in case of side mounted applications, separators with wide base 211.28 or (not series 2500) can be used
- **Strain Relief Separator 2020.Z**, integrable in the mounting bracket, to position at any point

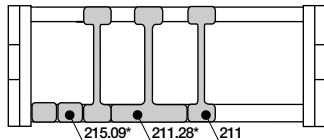

Vert. Separator, slotted	
unassembled	202
assembled	212



Side Plate	
unassembled	203
assembled	213



### Option 2: Full-Width Shelves for E-Chains®

For applications involving many thin cables with similar or identical diameters

- Vertical Separator, slotted 212 and Side Plate 213 - for applications with Full-Width Shelf 221.X

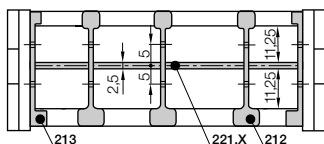

Full-Width Shelf	
X - 1	
t = 2,5	

Width X [mm]	Part No. unassembled	Part No. assembled
25	220.25	221.25
38	220.38	221.38
57	220.57	221.57
77	220.77	221.77

Width X [mm]	Part No. unassembled	Part No. assembled
90	220.90	221.90
103	220.103	221.103
125	220.125	221.125

Side Plate	
unassembled	2030
assembled	2130



Vert. Separator, slotted	
unassembled	2040
assembled	2140



Middle Plate	
unassembled	2020
assembled	2120



### Option 3: Shelves for E-Chains®

For applications involving many cables with different diameters. The Shelves can be arranged elevator-shifted with different bottoms within the entire E-Chain® width.

- Shelf 2210.X can be combined with Middle Plate 2120,
- Vertical Separator, slotted 2140 and Side Plate 2130

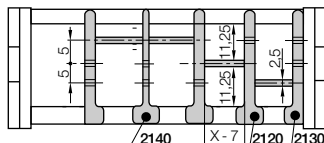

Shelf	
X	
X - 7	
t = 2,5	

Width X [mm]	Part No. unassembled	Part No. assembled
18	2200.18	2210.18
23	2200.23	2210.23
28	2200.28	2210.28
33	2200.33	2210.33
38	2200.38	2210.38
43	2200.43	2210.43

Width X [mm]	Part No. unassembled	Part No. assembled
48	2200.48	2210.48
58	2200.58	2210.58
68	2200.68	2210.68
73	2200.73	2210.73
88	2200.88	2210.88
99	2200.99	2210.99

**Option 4: Vertical Separators for E-Tubes**

Vertical Separators are used if a vertical subdivision of the E-Tube interior is required -

By standard Vertical Separators are assembled every other E-Tube link

- Standard subdivision of the half E-Tube (Series 2450) and the fully enclosed E-Tube (Series 2480) with Vertical Separator, slotted 24511, for combinations with Full-Width Shelf 221.X
- Strain Relief Separator 2020.ZR, integrable in the mounting bracket, to position at any point

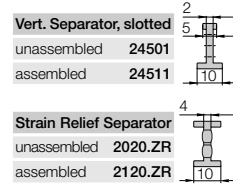

E2/000 medium  
Inner height: 25 mm

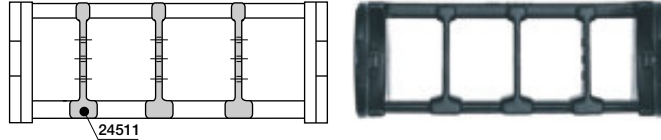

**Option 5: Full-Width Shelves for E-Tubes**

For applications involving many thin cables with similar or identical diameters

- Vertical Separator, slotted 24511 - for applications with Full-Width Shelf 221.X

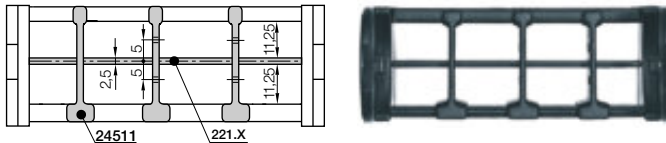

Width X [mm]	Part No. unassembled	Part No. assembled
25	220.25	221.25
38	220.38	221.38
57	220.57	221.57
77	220.77	221.77

Width X [mm]	Part No. unassembled	Part No. assembled
90	220.90	221.90
103	220.103	221.103
125	220.125	221.125

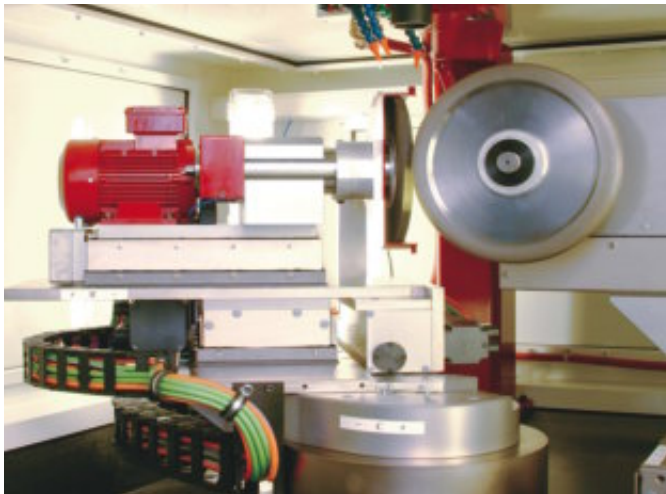
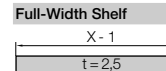

Two fully harness E2/000 E-Chains® with high fill weight, side mounted



▶ page 5.83



Possible installation conditions for assembled mounting brackets ▶ Order example "preassembled" below

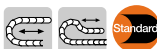

### The Standard - option polymer - pivoting

- Recommended for unsupported and gliding applications
- Well suited for tight installation conditions
- Strain relief with detachable tiewrap plates
- Variable traverse angle for flexible assembly
- The twistability of the E-Chain® and the option to assemble the mounting brackets on the fixed end and/or the moving end, enable various installation options

Moving end with bore  
(outer link) 2...3PZ(B)+

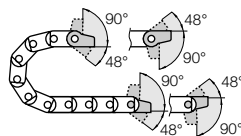

2...4PZ(B)+ Fixed end  
with pin (inner link)



Possible installation conditions for assembled mounting brackets ▶ Order example "preassembled" below

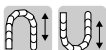

### Option polymer - locking

- Recommended for unsupported and gliding applications
- At very high speed and/or acceleration
- If space is limited for height (the  $H_F$  measurement)
- The twistability of the E-Chain® and the option to assemble the mounting brackets on the fixed end and/or the moving end, enable various installation options

Moving end with bore  
(outer link) 2...1PZ(B)+

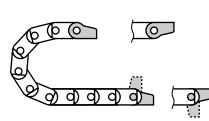

2...2PZ(B)+ Fixed end  
with pin (inner link)

## Dimensions and order configurations

Strain relief is possible on the moving end and/or the fixed end.

### Part No. structure (pivoting)

2020. 34 PZB+ A1

A... must be indicated on preassembled configurations  
With assembled strain relief tiewrap plates  
Full set pivoting = 34  
Mounting brackets for selected chain type

### Full set, for both ends:

2020. 34 PZB+ + tiewrap plate

### Single-part order:

2020. 3 PZB+ + tiewrap plate

Mounting bracket with bore

2020. 4 PZB+ + tiewrap plate

Mounting bracket with pin

### Part No. structure (locking)

2020. 12 PZB+ A1

A... must be indicated on preassembled configurations  
With assembled strain relief tiewrap plates  
Full set locking = 12  
Mounting brackets for selected chain type

### Full set, for both ends:

2020. 12 PZB+ + tiewrap plate

### Single-part order:

2020. 1 PZB+ + tiewrap plate

Mounting bracket with bore

2020. 2 PZB+ + tiewrap plate

Mounting bracket with pin

2...3PZ(B)+ Standard! (pivoting)

2...1PZ(B)+ (locking)

Moving end

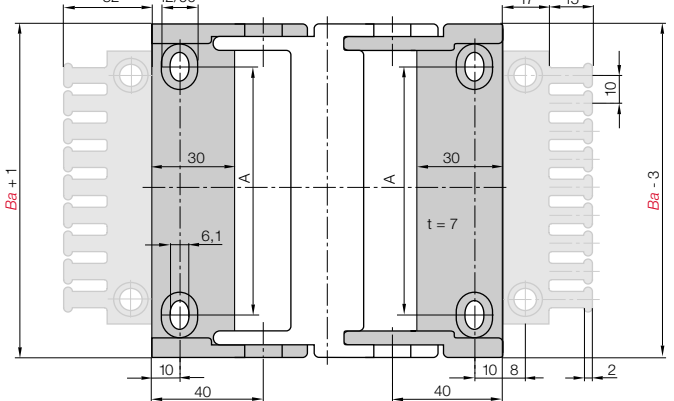

Standard! (pivoting) 2...4PZ(B)+

(locking) 2...2PZ(B)+

Fixed end

For E-Chain®	Part No. full set with tiewrap plate	Part No. with tiewrap plate + 10 cable tiewraps	Part No. full set without tiewrap plate	Dim. A [mm]
2400 - 2500.02 ▶	2020. <input type="checkbox"/> PZB+	2020. <input type="checkbox"/> PZBK1+	2020. <input type="checkbox"/> PZ+	12
2400 - 2500.03 ▶	2030. <input type="checkbox"/> PZB+	2030. <input type="checkbox"/> PZBK1+	2030. <input type="checkbox"/> PZ+	25
2400 - 2500.05 ▶	2050. <input type="checkbox"/> PZB+	2050. <input type="checkbox"/> PZBK1+	2050. <input type="checkbox"/> PZ+	44
2400 - 2500.07 ▶	2070. <input type="checkbox"/> PZB+	2070. <input type="checkbox"/> PZBK1+	2070. <input type="checkbox"/> PZ+	64
2400 - 2500.09 ▶	2090. <input type="checkbox"/> PZB+	2090. <input type="checkbox"/> PZBK1+	2090. <input type="checkbox"/> PZ+	77
2400 - 2500.10 ▶	2100. <input type="checkbox"/> PZB+	2100. <input type="checkbox"/> PZBK1+	2100. <input type="checkbox"/> PZ+	90
2400 - 2500.12 ▶	2125. <input type="checkbox"/> PZB+	2125. <input type="checkbox"/> PZBK1+	2125. <input type="checkbox"/> PZ+	112

Please add the Part No. with the requested index - 34 for the pivoting configuration

e.g. 2020. 34 PZB+ or 12 for the locking configuration e.g. 2020. 12 PZB+

For the preassembled mode please add the index A1...A4 e.g. 2020. 34 PZB+ A1



### Steel mounting bracket - pivoting

- Pivoting connections
- One part for all chain widths
- Electrically conductive
- Bolted connection outside of chain cross-section possible

Moving end with bore  
(outer link) 2000.3

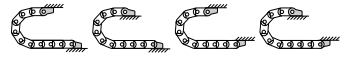
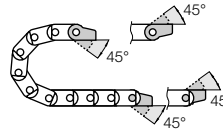

2000.2 Fixed end  
with pin (inner link)

Possible installation conditions -  
Further installation angles ► installation sketch

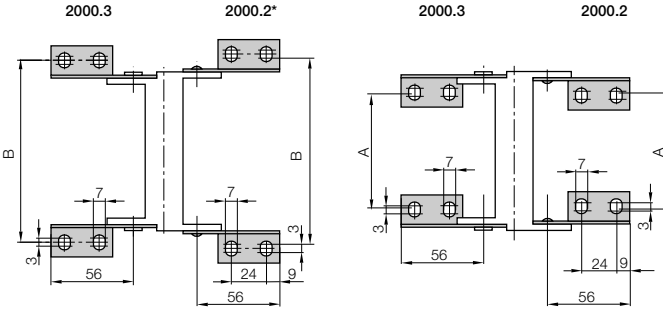

### Dimensions and order configurations

\*pivoting with no stop, (360°)

For E-Chain®	Part No. full set	Dim. A [mm]	Dim. B [mm]
2400 – 2500.02 ►	2000. [32]	-	60
2400 – 2500.03 ►	2000. [32]	25	73
2400 – 2500.05 ►	2000. [32]	44	92
2400 – 2500.07 ►	2000. [32]	64	112
2400 – 2500.09 ►	2000. [32]	76	124
2400 – 2500.10 ►	2000. [32]	90	138
2400 – 2500.12 ►	2000. [32]	112	160

2000. [32] Full set, 4 parts

2 with pin / 2 with bore

Single-part order:

2000. [3] Mounting bracket

with bore, 1 part left / right

2000. [2] Mounting bracket

with pin, 1 part left / right

Phone +49- (0) 22 03-96 49-800  
Fax +49- (0) 22 03-96 49-222



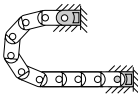

The attachment variants arising automatically by the choice of the KMA mounting bracket

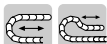

KMA = Polymer Metal Mounting Bracket

### Option KMA, pivoting for E-Chains® Series 2400 and Series 2500

- Recommended for unsupported applications
- Bolted connection outside of chain cross-section
- Confined installation conditions
- Universal mountable with attachment capability on all sides
- Strain relief separator pluggable into the KMA-bracket, adjustable in 3 heights
- Stackable

Moving end with bore  
Series 2400 = 24001...1  
Series 2500 = 24001...1

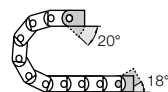

Series 2400 = 24001...2  
Series 2500 = 24001...2

Fixed end with pin

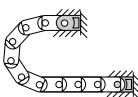
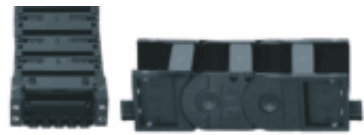

The attachment variants arising automatically by the choice of the KMA mounting bracket



KMA = Polymer Metal Mounting Bracket

### Option KMA, locking for E-Chains® Series 2400 and Series 2500

- Recommended for vertical hanging / standing applications
- Bolted connection outside of chain cross-section
- At very high speed and acceleration
- Universal mountable with attachment capability on all sides
- Strain relief separator pluggable into the KMA-bracket, adjustable in 3 heights
- Stackable

Moving end with bore  
Series 2400 = 24101...1  
Series 2500 = 24101...1

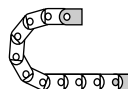

Series 2400 = 24101...2  
Series 2500 = 24101...2

Fixed end with pin

## Dimensions and order configurations

2400 | 2500 = 24001...1 (pivoting)

2400 | 2500 = 24001...2 (pivoting)

2400 | 2500 = 24101...1 (locking)

2400 | 2500 = 24101...2 (locking)

Moving end

Fixed end

### Part No. structure (pivoting)

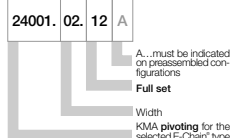

Full set, for both ends:

24001.02.12

Single-part order:

24001.02.1

Mounting bracket with bore

24001.02.2

Mounting bracket with pin

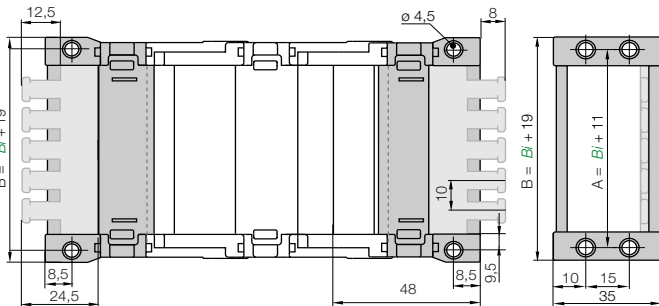

### Part No. structure (locking)

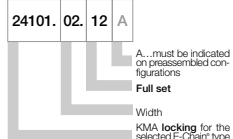

Full set, for both ends:

24101.02.12

Single-part order:

24101.02.1

Mounting bracket with bore

24101.02.2

Mounting bracket with pin

For E-Chain®	Part No. full set with tiewrap plate	Part No. full set without tiewrap plate	Dim. A [mm]	Dim. B [mm]
Series 2400/2500	2400.02 / 2500.02 ▶ [ ] .02.12.ZB	[ ] .02.12	36	44
	2400.03 / 2500.03 ▶ [ ] .03.12.ZB	[ ] .03.12	49	57
	2400.05 / 2500.05 ▶ [ ] .05.12.ZB	[ ] .05.12	68	76
	2400.07 / 2500.07 ▶ [ ] .07.12.ZB	[ ] .07.12	88	86
	2400.09 / 2500.09 ▶ [ ] .09.12.ZB	[ ] .09.12	100	108
	2400.10 / 2500.10 ▶ [ ] .10.12.ZB	[ ] .10.12	114	122
	2400.12 / 2500.12 ▶ [ ] .12.12.ZB	[ ] .12.12	136	144

● For E-Chains® please add the Part No. with the requested index

For the pivoting option e.g. 24001.02.12 or for the locking option e.g. 24101.02.12

For the preassembled mode please add the index [A] e.g. 24001.02.12[A]



**Option KMA, pivoting for half E-Tubes Series 2450 and for full E-Tubes Series 2480**

- Recommended for unsupported applications
- Bolted connection outside of chain cross-section
- Confined installation conditions
- Universal mountable with attachment capability on all sides
- Strain relief separator pluggable into the KMA-bracket, adjustable in 3 heights
- Stackable

**Moving end with bore**  
Series 2450 = 24501...1  
Series 2480 = 24801...1

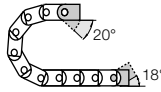

Series 2450 = 24501...2  
Series 2480 = 24801...2  
**Fixed end with pin**

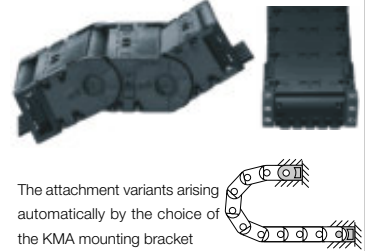

The attachment variants arising automatically by the choice of the KMA mounting bracket

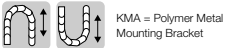

**Option KMA, locking for half E-Tubes Series 2450 and for full E-Tubes Series 2480**

- Recommended for vertical hanging / standing applications
- Bolted connection outside of chain cross-section
- At very high speed and acceleration
- Universal mountable with attachment capability on all sides
- Strain relief separator pluggable into the KMA-bracket, adjustable in 3 heights
- Stackable

**Moving end with bore**  
Series 2450 = 24511...1  
Series 2480 = 24811...1

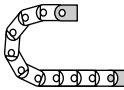

Series 2450 = 24511...2  
Series 2480 = 24811...2  
**Fixed end with pin**

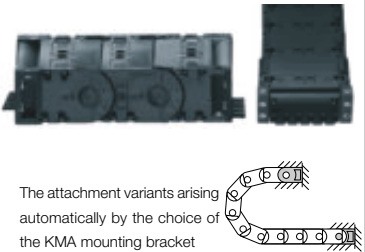

The attachment variants arising automatically by the choice of the KMA mounting bracket

2450 = 24501...1 | 2480 = 24801...1 (pivoting)      2450 = 24501...2 | 2480 = 24801...2 (pivoting)  
2450 = 24511...1 | 2480 = 24811...1 (locking)      2450 = 24511...2 | 2480 = 24811...2 (locking)

**Moving end**

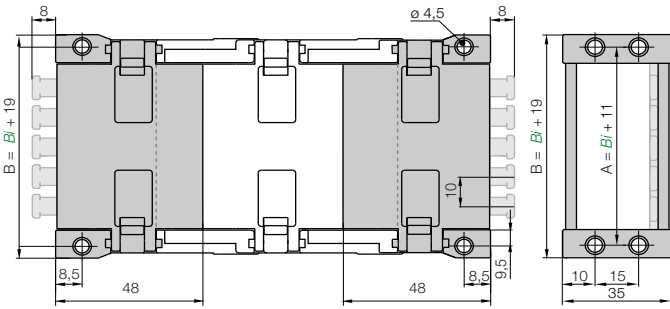

**Fixed end**

**Dimensions and order configurations**

**Part No. structure (pivoting)**

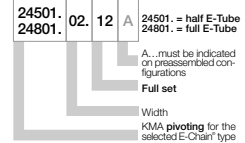

**Full set, for both ends:**

24501. / 24801. 02. 12

**Single-part order:**

24501. / 24801. 02. 1

Mounting bracket with bore

24501. / 24801. 02. 2

Mounting bracket with pin

**Part No. structure (locking)**

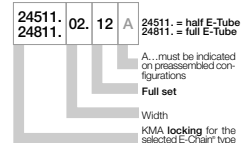

**Full set, for both ends:**

24511. / 24811. 02. 12

**Single-part order:**

24511. / 24811. 02. 1

Mounting bracket with bore

24511. / 24811. 02. 2

Mounting bracket with pin

For E-Chain®	Part No. full set with tiewrap plate	Part No. full set without tiewrap plate	Dim. A [mm]	Dim. B [mm]
Series 2400/2500				
2450.02 / 2480.02	02.12.ZB	02.12	36	44
2450.03 / 2480.03	03.12.ZB	03.12	49	57
2450.05 / 2480.05	05.12.ZB	05.12	68	76
2450.07 / 2480.07	07.12.ZB	07.12	88	96
2450.09 / 2480.09	09.12.ZB	09.12	100	108
2450.10 / 2480.10	10.12.ZB	10.12	114	122
2450.12 / 2480.12	12.12.ZB	12.12	136	144

- For **half E-Tube** please add the Part No. with the requested index  
For the pivoting option e.g. 24501.02.12 or for the locking option e.g. 24511.02.12  
For the **preassembled** mode please add the index [A] e.g. 24501.02.12[A]
- For **full E-Tube** please add the Part No. with the requested index  
For the pivoting option e.g. 24801.02.12 or for the locking option e.g. 24811.02.12  
For the **preassembled** mode please add the index [A] e.g. 24801.02.12[A]

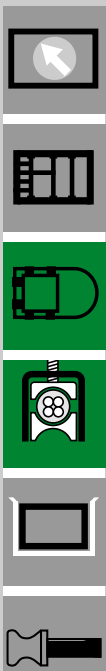





### Tiewrap plate as individual part

As individual component screwed on KMA. Can be plugged in the mounting brackets. **Details ▶ chapter 10**

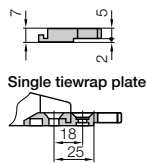

Shown assembled

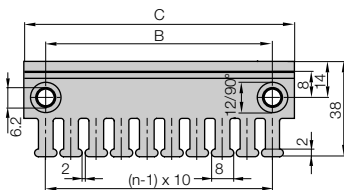

Tiewrap plate	No. of teeth n	Dim. C [mm]	Dim. B [mm]
2020.ZB	3	30	15
2030.ZB	4	40	20
2040.ZB	5	50	30
2050.ZB	6	60	40
2070.ZB	8	80	60
2090.ZB = (2030.ZB + 2040.ZB)	9	90	–
2100.ZB	10	100	80
2125.ZB = (2050.ZB + 2050.ZB)	12	120	–



### Cable tiewraps as individual part

Cable tiewraps (100-piece bag)	Width x length	max. Ø	Tensile strength
CFB.001	4,8 x 150 mm	36 mm	222 N



### "Double" strain relief

If an E-Chain® is harnessed with a very large number of cables, strain relief may be necessary at two levels. Our 2050.Z strain relief system was developed for this purpose. It can be placed in any position along the E-Chain®. As required, the 2050.Z strain relief system is simply clamped onto the crossbar of the chain link. No additional installation elements are needed. **Details ▶ chapter 10**

Part No.	Width strain relief [mm]	
2050.Z*	60	*not für Series 2450/2480 available

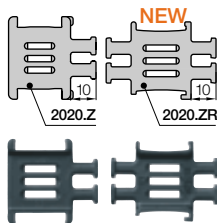

### Strain relief separator

Separator with integrated strain relief, for use in the first or last chain link. For manufacturing of switchgear cabinets or for the assembly of machines. Easy to assemble without any fastening device. Separator base 2020.Z and 2020.ZR is 10 mm wide. The possible number of separators per E-Chain® is defined by its inner width  $B_i$  and by the cable-diameter. **Details ▶ chapter 10**

Part No.	Number of teeth	For Series
2020.Z	2 one side	2400/2500 E-Chain®
2020.ZR	2 both sides	2450/2480 E-Tube



### Strain relief for steel mounting brackets

Clip-on connection is not possible with steel mounting brackets. In this case, the tie-wrap plates must be bolted directly into separate bore holes in front of the mounting bracket. Alternatively the tie-wrap plates 20XX.ZB can be also used here. **Details ▶ chapter 10**



Other strain relief elements - optional ▶ chapter 10

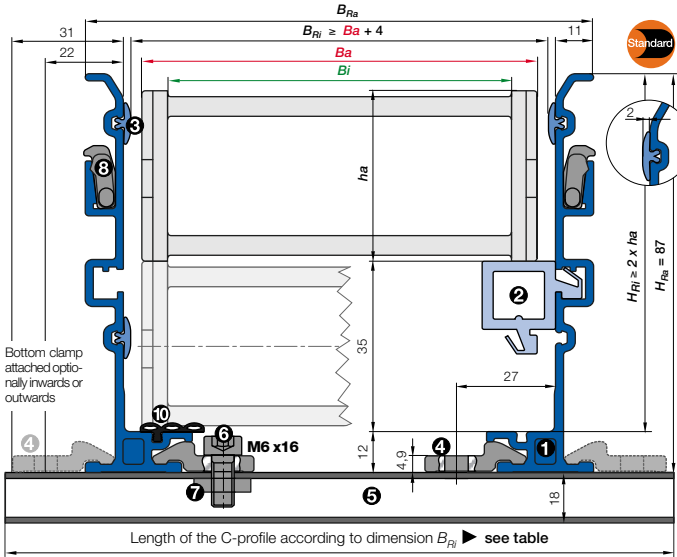

- B<sub>a</sub>** = Outer width E-Chains® / E-Tube
  - B<sub>i</sub>** = Inner width E-Chains® / E-Tube
  - h<sub>a</sub>** = Outer height E-Chains® / E-Tube
  - H<sub>Ri</sub>** = Inner trough height
  - H<sub>Ra</sub>** = Outer trough height
  - B<sub>Ri</sub>** = Inner trough width ▶ depends on dim. B<sub>a</sub>
  - B<sub>Ra</sub>** = Outer trough width
  - n<sub>Mon</sub>** = Number of installation sets (left/right)
  - n<sub>Ri</sub>** = Number of trough sets (left/right)
- $H_{Ri} \geq 2 \cdot h_a$   
 $B_{Ri} \geq B_a + 4$
- = Guide trough set
  - = Installation set "Basic"
  - = Glide bar
  - = C-profile

**Installation set "Basic" with C-profile**

Bottom Clamp attached optionally inwards or outwards

2500.05.200.0 ▶ Order example

B <sub>Ri</sub> [mm]	Part No.	
	attached inwards	attached outwards
.02	45	960.30.150
.03	58	960.30.150
.05	77	960.30.125 960.30.175
.07	97	960.30.150 960.30.200
.09	109	960.30.175 960.30.225
.10	123	960.30.175 960.30.225
.12	145	960.30.200 960.30.250



- **Components, trough "Basic":** ① Trough side parts, aluminum, 2 m ② Glide bar, plastic, 2 m ③ Glide strips, plastic, 2 m (without glide strips on request) ⑩ Optional: Silencer profile, rubber
- **Components, installation set "Basic":** ④ Bottom clamp, aluminum ⑤ C-profile, steel galvanized ⑥ Screw M6 x16 ⑦ Sliding nut M6 ⑧ Interface connector, plastic

**Order example: Length of travel 30 m - Center mounted for Series 2500.05.200.0 with B<sub>Ri</sub> = 77**

- Guide trough set (set of 2 trough side parts, incl. glide strips) **without** glide bar  
**Order text: 16 m guide trough without glide bar (8 x 2 m sections)** Part No. 971.30.SL
- Guide trough set (set of 2 trough side parts, incl. glide strips) **with** glide bar  
**Order text: 16 m guide trough with glide bar (8 x 2 m sections)** Part No. 971.31.SL
- Installation set "Basic" complete (guide trough-sets + 1)  
**Order text: 17 installation sets "Basic"** Part No. 960.30.150
- Module for the fixed end  
**Order text: 1 set** Part No. 971.80
- Option:** For an additional noise dampening with silencer profile, please add Index A - Example: Part No. 971.30.SLA

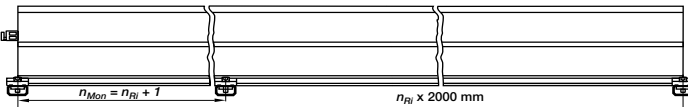

Principle sketch: Number of installation sets to be installed = **Number of trough sections + 1**

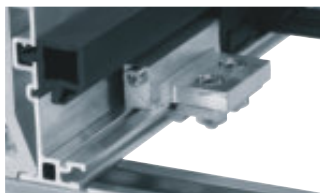

**New!** A quick fix for mounting the stationary end of an E-Chain®  
 With this new module for the fixed end, fast and easy mounting onto the Aluminum "SuperTrough" is now possible without any drilling. Fast mounting of the E-Chain® by clamping onto the aluminum trough

- Quick relocation of the stationary end
- No drilling necessary

Insert for the installation set "Heavy-Duty": **971.50.XXX** instead of (960.30.XXX) on the right column "attached outwards"

Phone +49- (0) 22 03-96 49-800  
 Fax +49- (0) 22 03-96 49-222



▶ page 5.83

● ● ● Price index



IPA Qualification Certificate Air  
Cleanless Class ISO Class 3  
(at v = 2 m/s) upon request



ESD classification:  
Electrically conductive ESD/ATEX  
version upon request



UL94 V2 classifications  
upon request



New snap-open mechanism, choice of snap-open on left or right. Hinged crossbar can be swiveled by more than 180° on both sides. Lightning-fast closing by hand. Secure fit without additional locking devices.



When to use the Series 2600/2650/2680/2700:

- Snap-open accessibility along both radii
- If integrated strain relief is required at the connection point
- Modular interior separation
- If long service life is required
- If easy installation is required
- If half E-Tube is required (Series 2650)
- If fully enclosed E-Tube is required (Series 2680)



When not to use it:

- If maximum stability is required
  - ▶ System E4, Series 280, page 7.28
- If the application is very simple
  - ▶ Easy Chain®, Series E26, page 3.46
- E-Tubes with small bending radii 075
  - ▶ System E2 E-Tubes, Series R58, page 6.34

- ① Opening system for rapid opening, either from the right or the left
- ② Double stop dog for long unsupported length
- ③ Cross bars with high locking range
- ④ Lateral glide surfaces for side-mounted operation
- ⑤ Tried-and-tested mounting bracket
- ⑥ Integrated strain relief possible
- ⑦ Half E-Tube Series 2650
- ⑧ Series 2600 and 2650 snap-open along inner radius
- ⑨ Fully enclosed E-Tube Series 2680
- ⑩ Modular interior separation
- ⑪ Easy assembly by optimized pin
- ⑫ Also available as ESD version
- ⑬ Strain relief separator - Separator with integrated strain relief ▶ page 5.116

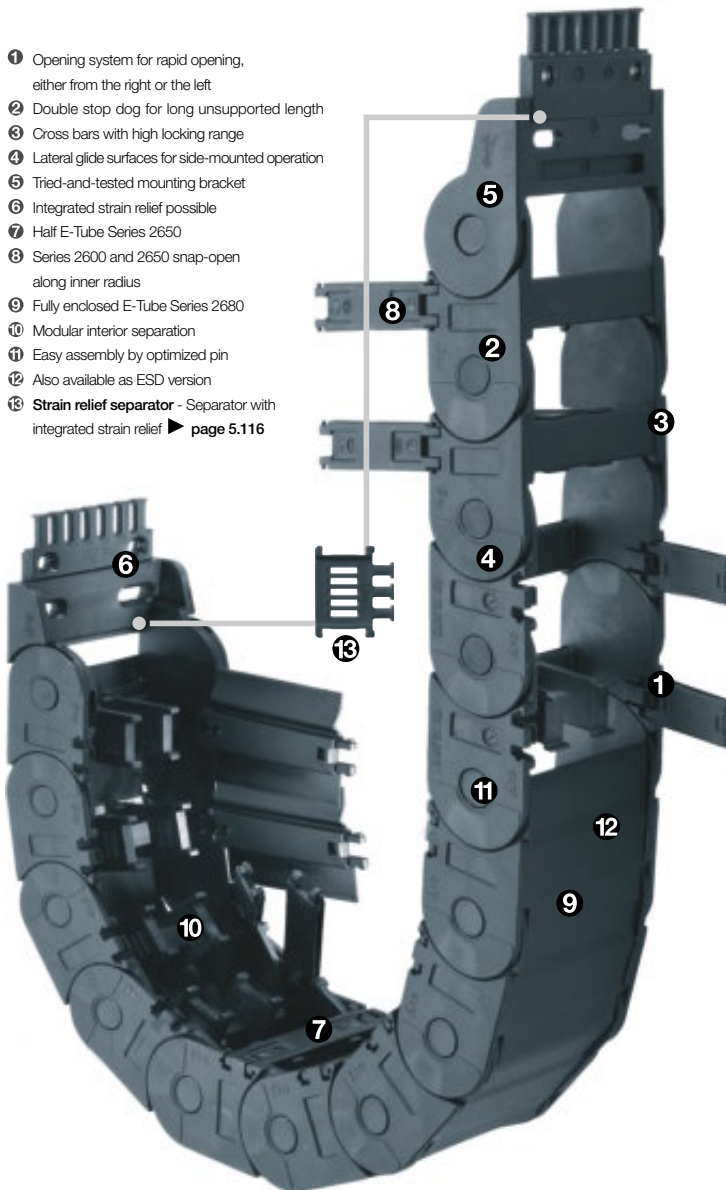

Order example complete E-Chain®

Please indicate chain-lengths or number of links Example: 3 m or 54 links

3 m 2700.10.100.0

E-Chain®

with 2 separators 261 assembled every 2<sup>nd</sup> link

Interior separation

1 set 2610.34PZB

Mounting bracket

### Unsupported length

$FL_G$  = with straight upper run

$FL_B$  = with permitted sag

Further information ► Design, page 1.12

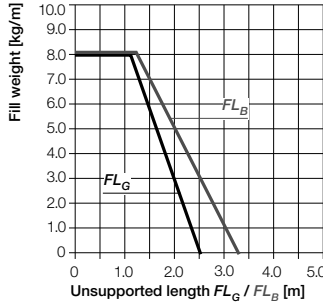
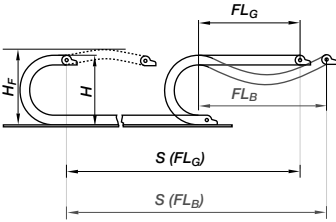

Length of travel S [m]

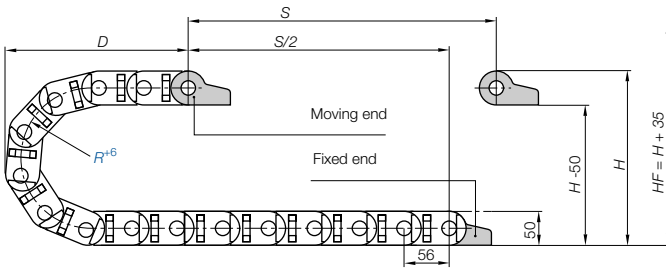
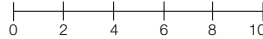

Pitch = 56 mm/link

Links/m = 18 (1008 mm)

Chain length =  $S/2 + K$

R	063*	075*	100	125	150	175	200	250
H	180	200	250	300	350	400	450	550
D	140	150	175	200	225	250	275	325
K	335	375	475	550	650	750	825	925
$D_2^{+25}$	-	-	400	465	610	775	970	1150
$K_2$	-	-	616	784	896	1120	1288	1624
$H_2$	-	-	166	166	166	166	166	166

\*for Series 2650/2680 upon request

- S = Length of travel
  - R = Bending radius
  - H = Nominal clearance height
  - $H_f$  = Required clearance height
  - $H_{in}$  = Trough inner height
  - D = Overlength E-Chain<sup>®</sup> radius in final position
  - $K = \pi \cdot R + \text{"safety"}$
  - $D_2$  = Overlength - long travels, gliding
  - $K_2$  = \*Further add-on
  - $H_2$  = \*Mounting height
- \*if the mounting bracket location is set lower

### Other installation methods

- Vertical, hanging  $\leq 50$  m
- Vertical, standing  $\leq 3$  m
- Side mounted, un supp.  $\leq 1$  m
- Rotary requires further calculation
- Unsupported length of upper run = upon request

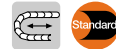

### Short travels - unsupported

Unsupported E-Chains<sup>®</sup> feature positive camber over short travels. This must be accounted for when specifying the clearance height  $H_f$ . Please consult igus<sup>®</sup> if space is particularly restricted.

The required clearance height:  
 $H_f = H + 35$  mm  
(with 2,0 kg/m fill weight)

### Long travel lengths from 10 m to max. 120 m

Chain length =  $S/2 + K_2$

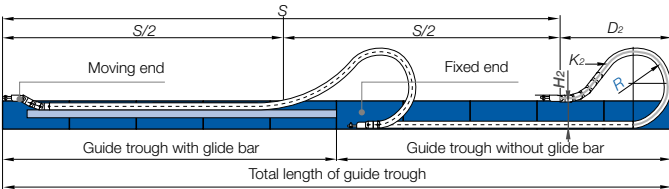

In case of travels between 4 and 10 m we recommend a longer unsupported length.



### Gliding, long travel applications (max. 120 m)

In this case the E-Chain<sup>®</sup> upper run will be introduced in a guide trough on the lower run. We recommend to realize the engineering of such a plant by our technicians.

Speed / acceleration $FL_G$	max. 20 [m/s] / max. 200 [m/s <sup>2</sup> ]
Speed / acceleration $FL_B$	max. 3 [m/s] / max. 6 [m/s <sup>2</sup> ]
Gliding speed / acceleration (maximum)	max. 10 [m/s] / max. 50 [m/s <sup>2</sup> ]
Material - permitted temperature °C	igumid G / -40° up to +130° C
Flammability class, igumid G	VDE 0304 IIC UL94 HB

### Technical Data



Details of material properties  
► page 1.38



E2/000 medium  
Inner height: 35 mm

Phone +49- (0) 22 03-96 49-800  
Fax +49- (0) 22 03-96 49-222



► page 5.83

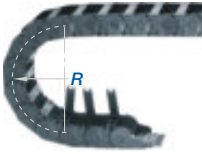
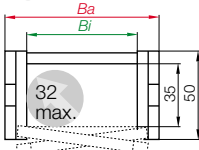

Part No. structure

2600. 05. 063. 0



Series 2600 - E-Chain® - snap-open along inner radius

Part No.	Bi [mm]	Ba [mm]	R [mm]	Bending radii								Weight [kg/m]
2600.05.	50	66	063	075	100	125	150	175	200	250	~ 1,17	
2600.06.	65	81	063	075	100	125	150	175	200	250	~ 1,24	
2600.07.	75	91	063	075	100	125	150	175	200	250	~ 1,30	
2600.09.	90	106	063	075	100	125	150	175	200	250	~ 1,37	
2600.10.	100	116	063	075	100	125	150	175	200	250	~ 1,39	
2600.12.	125	141	063	075	100	125	150	175	200	250	~ 1,48	
2600.15.	150	166	063	075	100	125	150	175	200	250	~ 1,62	
2600.17.	175	194	063	075	100	125	150	175	200	250	~ 1,85	

Supplement Part No. with required radius. Example: 2600.05.063.0

0 = standard color, other colors ▶ page 1.39 - Pitch = 56 mm/link - Links/m = 18

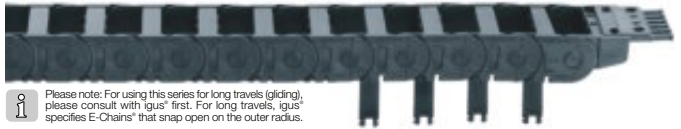

Please note: For using this series for long travels (gliding), please consult with igus® first. For long travels, igus® specifies E-Chains® that snap open on the outer radius.

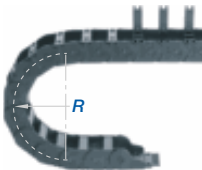
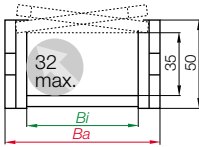

Part No. structure

2700. 05. 063. 0



**Standard** Series 2700 - E-Chain® - snap-open along outer radius - Standard!

Part No.	Bi [mm]	Ba [mm]	R [mm]	Bending radii								Weight [kg/m]
2700.05.	50	66	063	075	100	125	150	175	200	250	~ 1,17	
2700.06.	65	81	063	075	100	125	150	175	200	250	~ 1,24	
2700.07.	75	91	063	075	100	125	150	175	200	250	~ 1,30	
2700.09.	90	106	063	075	100	125	150	175	200	250	~ 1,37	
2700.10.	100	116	063	075	100	125	150	175	200	250	~ 1,39	
2700.12.	125	141	063	075	100	125	150	175	200	250	~ 1,48	
2700.15.	150	166	063	075	100	125	150	175	200	250	~ 1,62	
2700.17.	175	194	063	075	100	125	150	175	200	250	~ 1,85	

Supplement Part No. with required radius. Example: 2700.05.063.0

0 = standard color, other colors ▶ page 1.39 - Pitch = 56 mm/link - Links/m = 18



**Series 2650 - half E-Tube - snap-open along inner radius**

Part No.	Bi [mm]	Ba [mm]	R [mm]	Bending radii	Weight [kg/m]
2650.05.□.0	50	66	100	125 150 175 200 250	≈ 1,25
2650.06.□.0	65	81	100	125 150 175 200 250	≈ 1,36
2650.07.□.0	75	91	100	125 150 175 200 250	≈ 1,40
2650.09.□.0	90	106	100	125 150 175 200 250	≈ 1,55
2650.10.□.0	100	116	100	125 150 175 200 250	≈ 1,61
2650.12.□.0	125	141	100	125 150 175 200 250	≈ 1,70
2650.15.□.0	150	166	100	125 150 175 200 250	≈ 1,80
2650.17.□.0	175	194	100	125 150 175 200 250	≈ 2,00

The bending radii **063** **075** are available upon request. Delivery time: approx. 6-8 weeks after receipt of order  
 The widths **Bi 90 / 150 / 175** are available upon request. Time of delivery approx. 6-8 weeks after order.

Supplement Part No. with required radius. Example: 2650.05.**100**.0

0 = standard color, other colors ▶ page 1.39 · Pitch = 56 mm/link · Links/m = 18



**i** Please note: For using this series for long travels (gliding), please consult with igus® first. For long travels, igus® specifies E-Chains® that snap open on the outer radius.

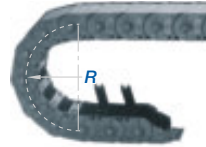
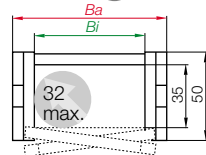

Part No. structure

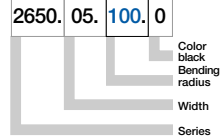

**Series 2680 - E-Tube - snap-open along inner radius**

Part No.	Bi [mm]	Ba [mm]	R [mm]	Bending radii	Weight [kg/m]
2680.05.□.0	50	66	100	125 150 175 200 250	≈ 1,33
2680.06.□.0	65	81	100	125 150 175 200 250	≈ 1,43
2680.07.□.0	75	91	100	125 150 175 200 250	≈ 1,51
2680.09.□.0	90	106	100	125 150 175 200 250	≈ 1,62
2680.10.□.0	100	116	100	125 150 175 200 250	≈ 1,81
2680.12.□.0	125	141	100	125 150 175 200 250	≈ 1,99
2680.15.□.0	150	166	100	125 150 175 200 250	≈ 2,17
2680.17.□.0	175	194	100	125 150 175 200 250	≈ 2,35

The bending radii **063** **075** are available upon request. Delivery time: approx. 6-8 weeks after receipt of order  
 The widths **Bi 90 / 150 / 175** are available upon request. Time of delivery approx. 6-8 weeks after order.

Supplement Part No. with required radius. Example: 2680.07.**100**.0

0 = standard color, other colors ▶ page 1.39 · Pitch = 56 mm/link · Links/m = 18



**i** Please note: For using this series for long travels (gliding), please consult with igus® first. For long travels, igus® specifies E-Chains® that snap open on the outer radius.

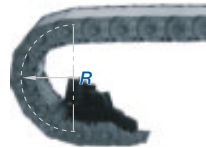
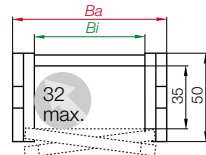

Part No. structure

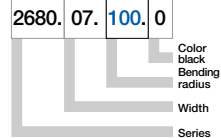

For smaller bending radii we recommend the fully closed E-Tubes, Series R58 ▶ page 6.34

E2/000 medium  
Inner height: 35 mm

Phone +49- (0) 22 03-96 49-800  
Fax +49- (0) 22 03-96 49-222



▶ page 5.83



**Vertical Separator**  
unassembled 260  
assembled 261



**Vertical Separator\***  
unassembled 260.24  
assembled 261.24



**Spacer\***  
unassembled 205.09  
assembled 215.09



**Strain Relief Separator**  
unassembled 262.Z  
assembled 263.Z



\*For side-mounted applications

### Option 1: Vertical Separators and Spacer for E-Chains®

Vertical Separators are used if a vertical subdivision of the E-Chain® interior is required -

By standard Vertical Separators are assembled every other E-Chain® link

- **Standard** subdivision (Series 2600/Series 2700) with Vertical Separator 261, for combinations with Full-Width Shelf 221.X
- If a broad distance shall be kept between the separators or they have to be fixed in their position, e.g. in case of side mounted applications, separators with **wide base 261.24** or **Spacer 215.09** can be used
- **Strain Relief Separator 262.Z**, integrable in the mounting bracket, to position at any point

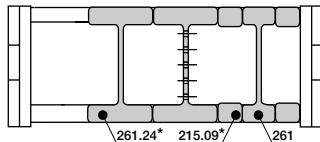

**Vert. Separator, slotted**  
unassembled 268  
assembled 269



### Option 2: Full-Width Shelves for E-Chains®

For applications involving many thin cables with similar or identical diameters

- Vertical Separator, slotted 269 - for applications with Full-Width Shelf 221.X

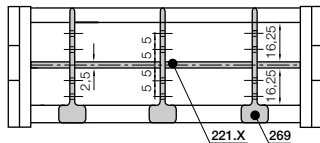

**Full-Width Shelf**  
X-1  
t = 2,5

Width X [mm]	Part No. unassembled	Part No. assembled
50	220.50	221.50
65	220.65	221.65
75	220.75	221.75
90	220.90	221.90

Width X [mm]	Part No. unassembled	Part No. assembled
100	220.100	221.100
125	220.125	221.125
150	220.150	221.150
175	220.175	221.175

**Middle Plate**  
unassembled 262  
assembled 263



### Option 3: Shelves for E-Chains®

For applications involving many cables with different diameters. The Shelves can be arranged elevator-shifted with different bottoms within the entire E-Chain® width

- Shelf 2210.X can be combined with Middle Plate 263, Slotted Separator 267 and Side Plate 265
- Option 3 "Shelves" can also be combined with option 1 "Vertical Separators"
- Assembling of the **Slotted Separator, open 277** in the existing separation afterwards possible

**Slotted Separator**  
unassembled 266  
assembled 267



**Slotted Separator, open**  
unassembled 276  
assembled 277



**Side Plate**  
unassembled 264  
assembled 265

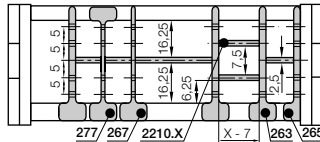

**Shelf**  
X  
X - 7  
t = 2,5

Width X [mm]	Part No. unassembled	Part No. assembled
18	2200.18	2210.18
23	2200.23	2210.23
28	2200.28	2210.28
33	2200.33	2210.33
38	2200.38	2210.38
43	2200.43	2210.43
48	2200.48	2210.48

Width X [mm]	Part No. unassembled	Part No. assembled
58	2200.58	2210.58
68	2200.68	2210.68
73	2200.73	2210.73
88	2200.88	2210.88
99	2200.99	2210.99
124	2200.124	2210.124
149	2200.149	2210.149



### Option 4: Vertical Separators for E-Tubes

Vertical Separators are used if a vertical subdivision of the E-Tube interior is required -

By standard Vertical Separators are assembled every other E-Tube link

- Standard subdivision of the half E-Tube (Series 2650) and the fully enclosed E-Tube (Series 2680) with Vertical Separator, slotted 26511, for combinations with Full-Width Shelf 221.X

Vert. Separator, slotted		
unassembled	26501	
assembled	26511	

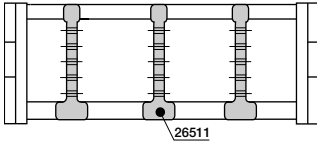

E2 medium  
Inner height: 35 mm

### Option 5: Full-Width Shelves for E-Tubes

For applications involving many thin cables with similar or identical diameters

- Vertical Separator, slotted 26511 - for applications with Full-Width Shelf 221.X

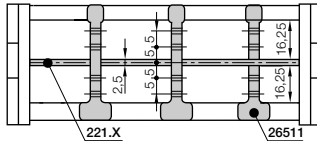

Width X [mm]	Part No. unassembled	Part No. assembled
50	220.50	221.50
65	220.65	221.65
75	220.75	221.75
90	220.90	221.90

Width X [mm]	Part No. unassembled	Part No. assembled
100	220.100	221.100
125	220.125	221.125
150	220.150	221.150
175	220.175	221.175

Full-Width Shelf	
X - 1	
t = 2,5	

Phone +49- (0) 22 03-96 49-800  
Fax +49- (0) 22 03-96 49-222

### Variante 6 - Shelves for E-Tubes

For applications involving many cables with different diameters. The Shelves can be arranged elevator-shifted with different bottoms within the entire E-Chain® width

- Shelf 2210.X can be combined with Vertical Separator, slotted 26511
- Assembling of the Slotted Separator, open 277 in the existing separation afterwards possible

Slotted Separator, open		
unassembled	276	
assembled	277	

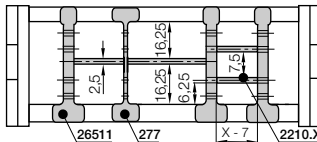

Width X [mm]	Part No. unassembled	Part No. assembled
18	2200.18	2210.18
23	2200.23	2210.23
28	2200.28	2210.28
33	2200.33	2210.33
38	2200.38	2210.38
43	2200.43	2210.43
48	2200.48	2210.48

Width X [mm]	Part No. unassembled	Part No. assembled
58	2200.58	2210.58
68	2200.68	2210.68
73	2200.73	2210.73
88	2200.88	2210.88
99	2200.99	2210.99

Shelf	
X	
X - 7	
t = 2,5	

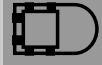

▶ page 5.83

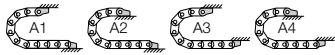
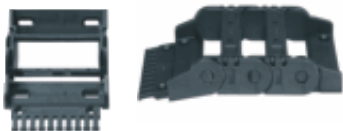

Possible installation conditions for assembled mounting brackets ► Order example "preassembled" below

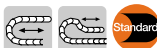

### The Standard - option polymer - pivoting

- Recommended for unsupported and gliding applications
- Well suited for tight installation conditions
- Strain relief with detachable tiewrap plates
- Variable traverse angle for flexible assembly
- The twistability of the E-Chain® and the option to assemble the mounting brackets on the fixed end and/or the moving end, enable various installation options

Moving end with bore  
(outer link) 26...3PZ(B)

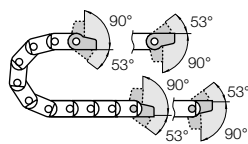

26...4PZ(B) Fixed end  
with pin (inner link)

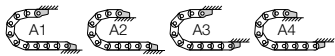

Possible installation conditions for assembled mounting brackets ► Order example "preassembled" below



### Option polymer - locking

- Recommended for unsupported and gliding applications
- At very high speed and/or acceleration
- If space is limited for height (the  $H_F$  measurement)
- The twistability of the E-Chain® and the option to assemble the mounting brackets on the fixed end and/or the moving end, enable various installation options

Moving end with bore  
(outer link) 26...1PZ(B)

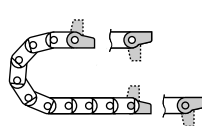

26...2PZ(B) Fixed end  
with pin (inner link)

## Dimensions and order configurations

Strain relief is possible on the moving end and/or the fixed end.

Part No. structure (pivoting)

2605. 34 PZB A1 Standard

A... must be indicated on preassembled configurations  
With assembled strain relief tiewrap plates  
Full set pivoting = 34  
Mounting brackets for selected chain type

Full set, for both ends:

2605. 34 PZB +tiewrap plate

Single-part order:

2605. 3 PZB +tiewrap plate

Mounting bracket with bore

2605. 4 PZB +tiewrap plate

Mounting bracket with pin

Part No. structure (locking)

2605. 12 PZB A1

A... must be indicated on preassembled configurations  
With assembled strain relief tiewrap plates  
Full set locking = 12  
Mounting brackets for selected chain type

Full set, for both ends:

2605. 12 PZB +tiewrap plate

Single-part order:

2605. 1 PZB +tiewrap plate

Mounting bracket with bore

2605. 2 PZB +tiewrap plate

Mounting bracket with pin

26...3PZ(B) Standard! (pivoting)

26...1PZ(B) (locking)

Moving end

Standard! (pivoting) 26...4PZ(B)

(locking) 26...2PZ(B)

Fixed end

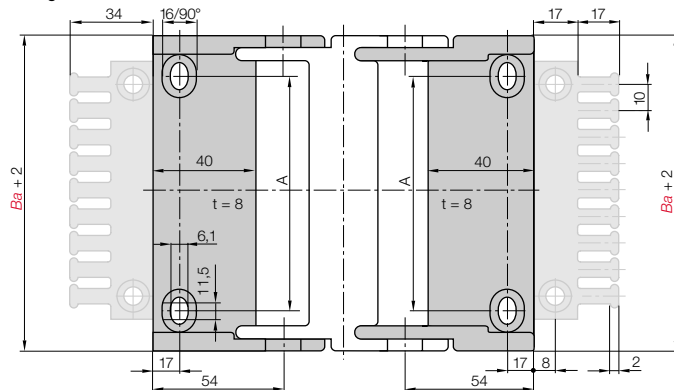

For E-Chain®	Part No. full set with tiewrap plate	Part No. with tiewrap plate + 10 cable tiewraps	Part No. full set without tiewrap plate	Dim. A [mm]
2600 – 2700.05 ►	2605. <input type="text"/> PZB	2605. <input type="text"/> PZBK1	2605. <input type="text"/> PZ	30
2600 – 2700.06 ►	2606. <input type="text"/> PZB	2606. <input type="text"/> PZBK1	2606. <input type="text"/> PZ	45
2600 – 2700.07 ►	2607. <input type="text"/> PZB	2607. <input type="text"/> PZBK1	2607. <input type="text"/> PZ	55
2600 – 2700.09 ►	2609. <input type="text"/> PZB	2609. <input type="text"/> PZBK1	2609. <input type="text"/> PZ	70
2600 – 2700.10 ►	2610. <input type="text"/> PZB	2610. <input type="text"/> PZBK1	2610. <input type="text"/> PZ	80
2600 – 2700.12 ►	2612. <input type="text"/> PZB	2612. <input type="text"/> PZBK1	2612. <input type="text"/> PZ	105
2600 – 2700.15 ►	2615. <input type="text"/> PZB	2615. <input type="text"/> PZBK1	2615. <input type="text"/> PZ	130
2600 – 2700.17 ►	2617. <input type="text"/> PZB	2617. <input type="text"/> PZBK1	2617. <input type="text"/> PZ	155

Please add the Part No. with the requested index - 34 for the pivoting configuration

e.g. 2605. 34 PZB or 12 for the locking configuration e.g. 2605. 12 PZB

For the preassembled mode please add the index A1...A4 e.g. 2605. 34 PZB A1



### Steel mounting bracket - locking

- Locked connections
- One part for all chain widths
- Electrically conductive
- Bolted connection outside of chain cross-section possible

Moving end with bore  
(outer link) 260.1

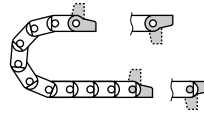

260.2 Fixed end  
with pin (inner link)

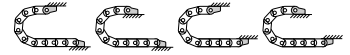

Possible installation conditions -  
Further installation angles ► installation sketch

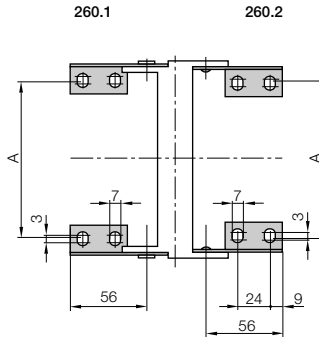
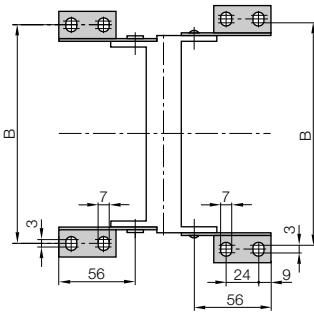

### Dimensions and order configurations

\*pivoting with no stop, (360°)

For E-Chain*	Part No. full set	Dim. A [mm]	Dim. B [mm]
2600 - 2700.05 ►	260. 12	37	83
2600 - 2700.06 ►	260. 12	52	98
2600 - 2700.07 ►	260. 12	62	108
2600 - 2700.09 ►	260. 12	77	123
2600 - 2700.10 ►	260. 12	87	133
2600 - 2700.12 ►	260. 12	112	158
2600 - 2700.15 ►	260. 12	137	183
2600 - 2700.17 ►	260. 12	163	209

260. 12 Full set, 4 parts

2 with pin / 2 with bore

Single-part order:

260. 1 Mounting bracket

with bore, 1 part left / right

260. 2 Mounting bracket with

pin, 1 part left / right

Phone +49- (0) 22 03-96 49-800  
Fax +49- (0) 22 03-96 49-222



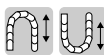

KMA = Polymer Metal  
Mounting Bracket

**Option KMA, locking for E-Chains®**  
Series 2600 and Series 2700

- Recommended for vertical hanging / standing applications
- Bolted connection outside of chain cross-section
- At very high speed and acceleration
- Universal mountable with attachment capability on all sides
- Stackable

Moving end with bore

Series 2600 = 26101...1

Series 2700 = 26101...1

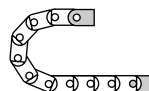

Series 2600 = 26101...2

Series 2700 = 26101...2

Fixed end with pin

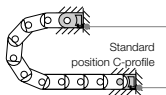

The attachment variants arising automatically by the choice of the KMA mounting bracket

**Dimensions and order configurations**



Option KMA, pivoting for E-Chains® on request

Part No. structure E-Chain®

26101.02.12.C.A

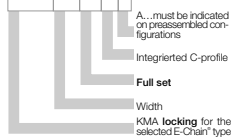

Full set, for both ends:

26101.02.12.C (with C-profile)

Bei Single-part order:

26101.02.1.C (with C-profile)

Mounting bracket with bore

26101.02.2.C (with C-profile)

Mounting bracket with pin

Series 2600 = 26101...1

Series 2700 = 26101...1

Moving end

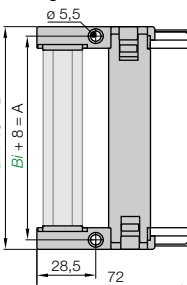

Series 2600 = 26101...2

Series 2700 = 26101...2

Fixed end

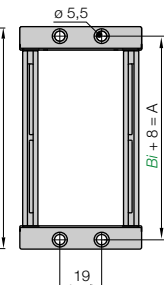

For E-Chain®	Part No. full set	Part No. full set	Dim. A [mm]	Dim B [mm]
Series 2600/2700	with C-profile	without C-profile		
2600/2700.05	26101.05.12.C	26101.05.12	58	69
2600/2700.06	26101.06.12.C	26101.06.12	73	84
2600/2700.07	26101.07.12.C	26101.07.12	83	94
2600/2700.09	26101.09.12.C	26101.09.12	98	109
2600/2700.10	26101.10.12.C	26101.10.12	108	119
2600/2700.12	26101.12.12.C	26101.12.12	133	144
2600/2700.15	26101.15.12.C	26101.15.12	158	169
2600/2700.17	26101.17.12.C	26101.17.12	183	194

For the preassembled mode please add the index A e.g. 26101.02.12.A

Phone +49- (0) 22 03-96 49-800  
Fax +49- (0) 22 03-96 49-222

igus® GmbH  
51147 Cologne

Internet: www.igus.de  
E-mail: info@igus.de

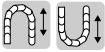

KMA = Polymer Metal Mounting Bracket

**Option KMA, locking for half E-Tubes Series 2650**  
**Option KMA, locking for full E-Tubes Series 2680**

- Recommended for vertical hanging / standing applications
- Bolted connection outside of chain cross-section
- At very high speed and acceleration
- Universal mountable with attachment capability on all sides
- Stackable

**Moving end with bore**

Series 2650 = 26510...1

Series 2680 = 26810...1

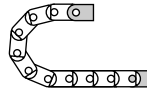

Series 2650 = 26510...2

Series 2680 = 26810...2

**Fixed end with pin**



The attachment variants arising automatically by the choice of the KMA mounting bracket

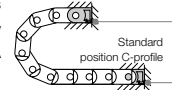

Series 2650 = 26510...1

Series 2680 = 26810...1

**Moving end**

ø 5,5

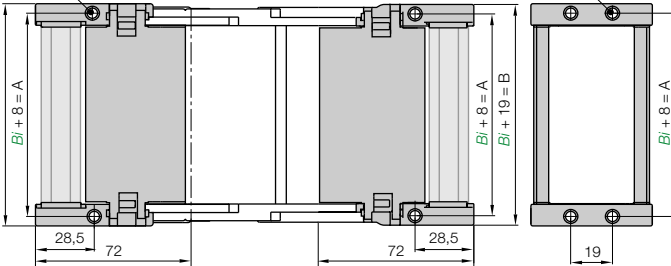

Series 2650 = 26510...2

Series 2680 = 26810...2

**Fixed end**

**Dimensions and order configurations**



**Option KMA, pivoting for half E-Tubes and full E-Tubes on request**

For E-Chain®	Part No. full set	Part No. full set	Dim. A [mm]	Dim B [mm]
Series 2650	with C-profile	without C-profile		
2650.05	26510_05.12.C	26510_05.12	58	69
2650.06	26510_06.12.C	26510_06.12	73	84
2650.07	26510_07.12.C	26510_07.12	83	94
2650.09	26101_09.12.C	26101_09.12	98	109
2650.10	26510_10.12.C	26510_10.12	108	119
2650.12	26510_12.12.C	26510_12.12	133	144
2650.15	26101_15.12.C	26101_15.12	158	169
2650.17	26101_17.12.C	26101_17.12	183	194

For the **preassembled** mode please add the index **A** e.g. **26510\_02.12 A**

For E-Chain®	Part No. full set	Part No. full set	Dim. A [mm]	Dim B [mm]
Series 2680	with C-profile	without C-profile		
2680.05	26810_05.12.C	26810_05.12	58	69
2680.06	26810_06.12.C	26810_06.12	73	84
2680.07	26810_07.12.C	26810_07.12	83	94
2680.09	26810_09.12.C	26810_09.12	98	109
2680.10	26810_10.12.C	26810_10.12	108	119
2680.12	26810_12.12.C	26810_12.12	133	144
2680.15	26810_15.12.C	26810_15.12	158	169
2680.17	26810_17.12.C	26810_17.12	183	194

For the **preassembled** mode please add the index **A** e.g. **26810\_02.12 A**

**Part No. structure half E-Tube**

26510\_02.12.C A

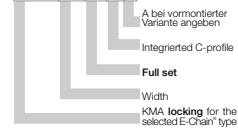

**Full set, for both ends:**

26510\_02.12.C (with C-profile)

**Bei Single-part order:**

26510\_02.12.C (with C-profile)

**Mounting bracket with bore**

26510\_02.12.C (with C-profile)

**Mounting bracket with pin**

**Part No. structure full E-Tube**

26810\_02.12.C A

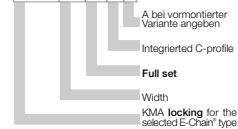

**Full set, for both ends:**

26810\_02.12.C (with C-profile)

**Bei Single-part order:**

26810\_02.1.C (with C-profile)

**Mounting bracket with bore**

26810\_02.2.C (with C-profile)

**Mounting bracket with pin**

Phone +49- (0) 22 03-96 49-800  
Fax +49- (0) 22 03-96 49-222



igus® E-ChainSystems®



### Tiewrap plate as individual part

As individual component screwed on KMA. Can be plugged in the mounting brackets. **Details ▶ chapter 10**

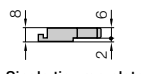

Single tie-strap plate

Shown assembled

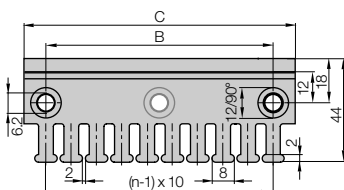

Tiewrap plate	No. of teeth $n$	Dim. C [mm]	Dim. B [mm]
3050.ZB	5	50	30
3075.ZB	7	75	55
3100.ZB	10	100	80
3115.ZB	11	115	95
3125.ZB	12	125	105
3150.ZB	15	150	130
3175.ZB	17	175	155
3200.ZB	20	200	180
3225.ZB	22	225	205
3250.ZB	25	250	230

(- = no / + = yes)

Phone +49- (0) 22 03-96 49-800  
Fax +49- (0) 22 03-96 49-222



### Cable tiewraps as individual part

Cable tiewraps (100-piece bag)	Width x length	max. Ø	Tensile strength
CFB.001	4,8 x 150 mm	36 mm	222 N



### "Double" strain relief

If an E-Chain® is harnessed with a very large number of cables, strain relief may be necessary at two levels. Our **2050.Z** strain relief system was developed for this purpose. It can be placed in any position along the E-Chain®. As required, the **2050.Z** strain relief system is simply clamped onto the crossbar of the chain link. No additional installation elements are needed. **Details ▶ chapter 10**

Part No.	Width strain relief [mm]	
2050.Z*	60	*not für Series 2650/2680 available

igus® GmbH  
51147 Cologne

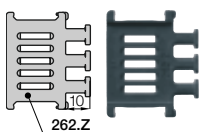

### Strain relief separator

Separator with integrated strain relief, for use in the first or last chain link. For manufacturing of switchgear cabinets or for the assembly of machines. Easy to assemble without any fastening device. Separator base 262.Z is 10 mm wide. The possible number of separators per E-Chain® is defined by its inner width  $B_i$  and by the cable-diameter. **Details ▶ chapter 10**

Part No.	Number of teeth	For Series
262.Z	3 one side	2600/2700 E-Chain®



### Strain relief for steel mounting brackets

Clip-on connection is not possible with steel mounting brackets. In this case, the tie-strap plates must be bolted directly into separate bore holes in front of the mounting bracket. Alternatively the tie-strap plates **30XX.Z** and **ZS** can be also used here. **Details ▶ chapter 10**

Internet: [www.igus.de](http://www.igus.de)  
E-mail: [info@igus.de](mailto:info@igus.de)



Other strain relief elements - optional ▶ chapter 10

### Chainfix strain relief C-profile-solutions - more Details ▶ chapter 10



Chainfix clamps made of steel or stainless steel



Chainfix Clips - modular, snap-on



Chainfix Nugget with pre-harnessed cable strap

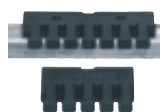

Chainfix - tie-strap plates with clip-on connection

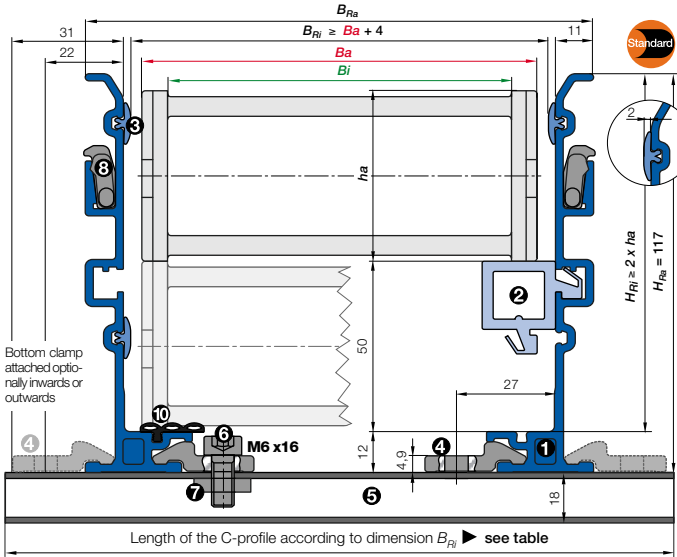

- Ba** = Outer width E-Chains® / E-Tube
  - Bi** = Inner width E-Chains® / E-Tube
  - ha** = Outer height E-Chains® / E-Tube
  - H<sub>Ri</sub>** = Inner trough height
  - H<sub>Ra</sub>** = Outer trough height
  - B<sub>Ri</sub>** = Inner trough width ▶ depends on dim. Ba
  - B<sub>Ra</sub>** = Outer trough width
  - n<sub>Mon</sub>** = Number of installation sets (left/right)
  - n<sub>Ri</sub>** = Number of trough sets (left/right)
- $H_{Ri} \geq 2 \times ha$   
 $B_{Ri} \geq Ba + 4$
- = Guide trough set
  - = Installation set "Basic"
  - = Glide bar
  - = C-Profile

**Installation set "Basic" with C-Profile**

Bottom Clamp attached optionally inwards or outwards

2700.05.200.0 ▶ Order example

$B_{Ri}$ [mm]	Part No.	
	attached inwards	attached outwards
.05	70	960.30.175
.06	85	960.30.150 960.30.200
.07	95	960.30.150 960.30.200
.09	110	960.30.175 960.30.225
.10	120	960.30.175 960.30.225
.12	145	960.30.200 960.30.250
.15	170	960.30.225 960.30.275
.17	198	960.30.250 960.30.300



- **Components, trough "Basic":** ① Trough side parts, aluminum, 2 m ② Glide bar, plastic, 2 m ③ Glide strips, plastic, 2 m (without glide strips on request) ⑩ Optional: Silencer profile, rubber
- **Components, installation set "Basic":** ④ Bottom clamp, aluminum ⑤ C-profile, steel galvanized ⑥ Screw M6 x16 ⑦ Sliding nut M6 ⑧ Interface connector, plastic

**Order example: Length of travel 30 m - Center mounted for Series 2700.06.200.0 with  $B_{Ri} = 85$**

Guide trough set (set of 2 trough side parts, incl. glide strips) <b>without</b> glide bar	<b>Part No.</b>	<b>972.30.SL</b>
<b>Order text:</b> 16 m guide trough without glide bar (8 x 2 m sections)		
Guide trough set (set of 2 trough side parts, incl. glide strips) <b>with</b> glide bar	<b>Part No.</b>	<b>972.32.SL</b>
<b>Order text:</b> 16 m guide trough with glide bar (8 x 2 m sections)		
Installation set "Basic" complete (guide trough-sets + 1)	<b>Part No.</b>	<b>960.30.150</b>
<b>Order text:</b> 17 installation sets "Basic"		
Module for the fixed end	<b>Part No.</b>	<b>972.81</b>
<b>Order text:</b> 1 set		
<b>Option:</b> For an additional noise dampening with silencer profile, please add Index A - Example:	<b>Part No.</b>	<b>972.30.SLA</b>

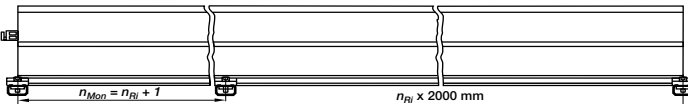

Principle sketch: Number of installation sets to be installed = **Number of trough sections + 1**

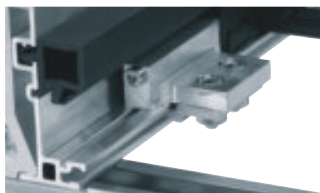

**New!** A quick fix for mounting the stationary end of an E-Chain®

- With this new module for the fixed end, fast and easy mounting onto the Aluminum "SuperTrough" is now possible without any drilling. Fast mounting of the E-Chain® by clamping onto the aluminum trough
- Quick relocation of the stationary end
  - No drilling necessary

Insert for the installation set "Heavy-Duty": **972.50.XXX** instead of (960.30.XXX) on the right column "attached outwards"

Phone +49- (0) 22 03-96 49-800  
 Fax +49- (0) 22 03-96 49-222

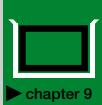
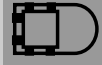

▶ page 5.83





● ● ● Price index



IPA Qualification Certificate Air  
Cleanless Class ISO Class 3  
(at  $v = 2$  m/s) upon request



ESD classification:  
Electrically conductive ESD/ATEX  
version upon request



UL94 V2 classifications  
upon request



New snap-open mechanism, choice of snap-open on left or right. Hinged crossbar can be swiveled by more than 180° on both sides. Lightning-fast closing by hand. Secure fit without additional locking devices.



When to use the Series 3400/3450/3480/3500:

- Snap-open accessibility along both radii
- If integrated strain relief is required at the connection point
- Modular interior separation
- If long service life is required
- If easy installation is required
- If half E-Tube is required (Series 3450)
- If fully enclosed E-Tube is required (Series 3480)



When not to use it:

- If maximum stability is required
  - ▶ System E4, Series 380, page 7.36
- If the application is very simple
  - ▶ Easy Chain®, Series E300, page 352

- ① Opening system for rapid opening, either from the right or the left
- ② Lateral glide surfaces for side-mounted operation
- ③ Half E-Tube Series 3450
- ④ Tried-and-tested mounting bracket
- ⑤ Series 3400 and 3450 snap-open along inner radius
- ⑥ Integrated strain relief possible
- ⑦ Double stop dog for long unsupported length
- ⑧ Cross bars with high locking range
- ⑨ Fully enclosed E-Tube Series 3480
- ⑩ Modular interior separation
- ⑪ Easy assembly by optimized pin
- ⑫ Also available as ESD version
- ⑬ **Strain relief separator** - Separator with integrated strain relief ▶ page 5.128

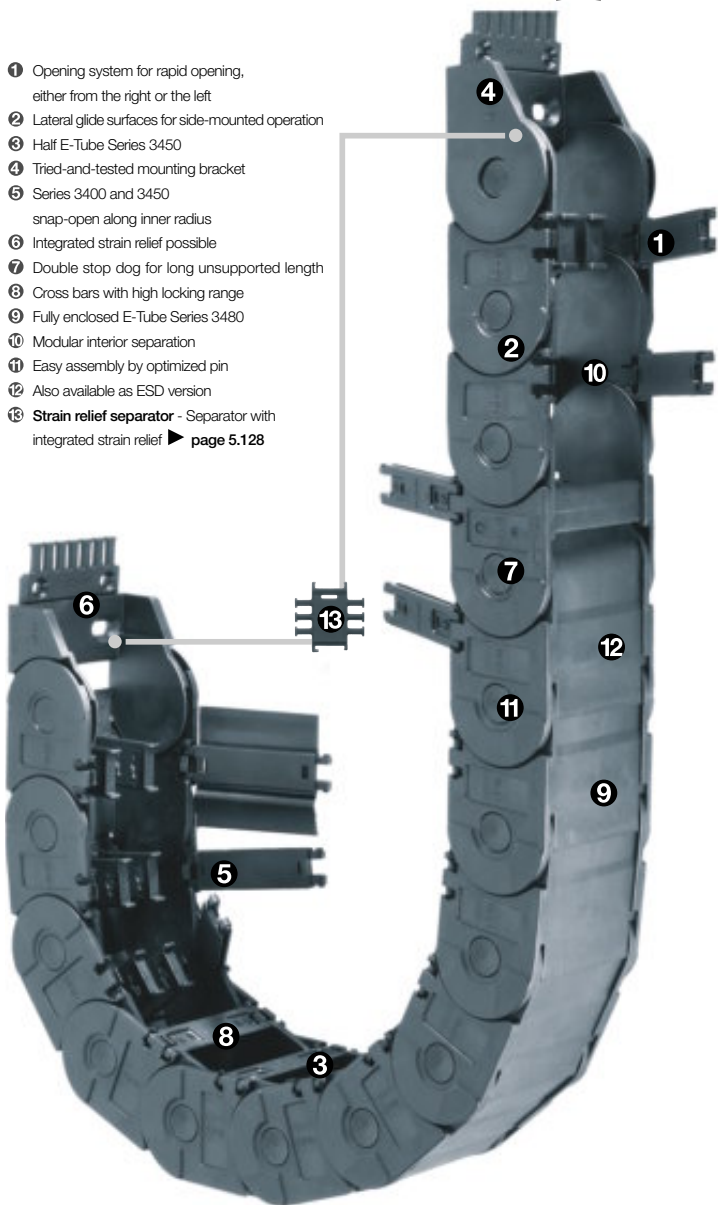

Order example complete E-Chain®

Please indicate chain-lengths or number of links Example: 3 m or 45 links

3 m 3400.150.100.0

E-Chain®

with 2 separators 311 assembled every 2<sup>nd</sup> link

Interior separation

1 set 3150.34PZB

Mounting bracket

### Unsupported length

$FL_G$  = with straight upper run

$FL_B$  = with permitted sag

Further information ► **Design, page 1.12**

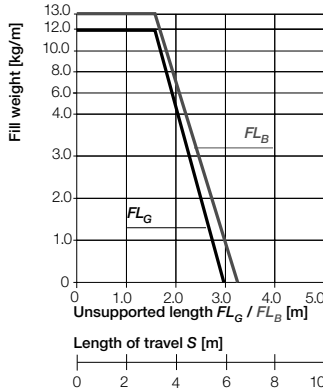
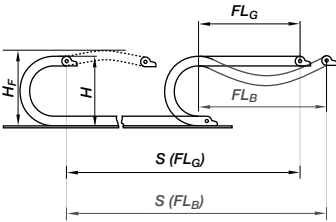

- $S$  = Length of travel
  - $R$  = Bending radius
  - $H$  = Nominal clearance height
  - $H_F$  = Required clearance height
  - $H_{in}$  = Trough inner height
  - $D$  = Overlength E-Chain® radius in final position
  - $K = \pi \cdot R + \text{"safety"}$
  - $D_2$  = Overlength - long travels, gliding
  - $K_2$  = \*Further add-on
  - $H_2$  = \*Mounting height
- \*if the mounting bracket location is set lower

#### Other installation methods

- Vertical, hanging  $\leq 80$  m
- Vertical, standing  $\leq 3$  m
- Side mounted, unupp.  $\leq 1$  m
- Rotary requires further calculation
- Unsupported length of upper run = upon request



### Short travels - unsupported

Unsupported E-Chains® feature positive camber over short travels. This must be accounted for when specifying the clearance height  $H_F$ . Please consult igus® if space is particularly restricted.

The required clearance height:  
 **$H_F = H + 40$  mm**  
(with 2,5 kg/m fill weight)

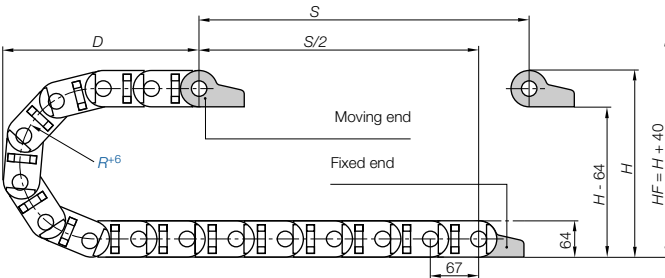

Pitch = 67 mm/link    Links/m = 15 (1005 mm)    Chain length =  $S/2 + K$

R	075°	100°	125	150	200	250	300
H	215	265	315	365	465	565	665
D	150	200	225	250	300	350	400
K	400	500	650	725	875	1050	1225
$D_2^{+25}$	-	-	475	570	780	1010	1150
$K_2$	-	-	804	1005	1340	1675	1943
$H_2$	-	-	186	186	186	186	186

\*for Series 3450/3480 upon request

### Long travel lengths from 10 m to max. 150 m    Chain length = $S/2 + K_2$

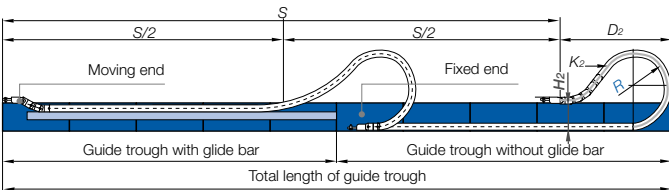

In case of travels between 4 and 10 m we recommend a longer unsupported length.



### Gliding, long travel applications (max. 150 m)

In this case the E-Chain® upper run will be introduced in a guide trough on the lower run. We recommend to realize the engineering of such a plant by our technicians.

Speed / acceleration $FL_G$	max. 20 [m/s] / max. 200 [m/s²]
Speed / acceleration $FL_B$	max. 3 [m/s] / max. 6 [m/s²]
Gliding speed / acceleration (maximum)	max. 10 [m/s] / max. 50 [m/s²]
Material - permitted temperature °C	igumid G / -40° up to +130° C
Flammability class, igumid G	VDE 0304 IIC UL94 HB

### Technical Data



Details of material properties  
► page 1.38



E2/000 medium  
Inner height: 45 mm

Phone +49- (0) 22 03-96 49-800  
Fax +49- (0) 22 03-96 49-222

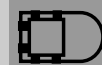

► page 5.83

igus® E-ChainSystems®

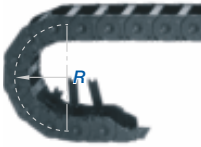
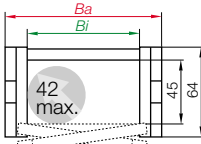

Part No. structure

3400.075.075.0



Series 3400 - E-Chain® - snap-open along inner radius

Part No.	Bi [mm]	Ba [mm]	R [mm]	Bending radii						Weight [kg/m]
3400.050.	50	70	075	100	125	150	200	250	300	~ 1,60
3400.075.	75	95	075	100	125	150	200	250	300	~ 1,78
3400.100.	100	120	075	100	125	150	200	250	300	~ 1,93
3400.115.	115	135	075	100	125	150	200	250	300	~ 1,99
3400.125.	125	145	075	100	125	150	200	250	300	~ 2,03
3400.150.	150	170	075	100	125	150	200	250	300	~ 2,17
3400.175.	175	195	075	100	125	150	200	250	300	~ 2,28
3400.200.	200	220	075	100	125	150	200	250	300	~ 2,45
3400.225.	225	245	075	100	125	150	200	250	300	~ 2,59
3400.250.	250	270	075	100	125	150	200	250	300	~ 2,73

Supplement Part No. with required radius. Example: 3400.050.075.0

0 = standard color, other colors ▶ page 1.39 · Pitch = 67 mm/link - Links/m = 15



Please note: For using this series for long travels (gliding), please consult with igus® first. For long travels, igus® specifies E-Chains® that snap open on the outer radius.

Phone +49- (0) 22 03-96 49-800  
Fax +49- (0) 22 03-96 49-222

igus® GmbH  
51147 Cologne

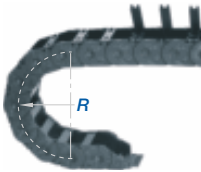
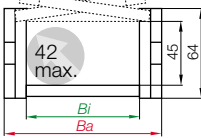

Part No. structure

3500.075.075.0



Series 3500 - E-Chain® - snap-open along outer radius - Standard!

Part No.	Bi [mm]	Ba [mm]	R [mm]	Bending radii						Weight [kg/m]
3500.050.	50	70	075	100	125	150	200	250	300	~ 1,60
3500.075.	75	95	075	100	125	150	200	250	300	~ 1,78
3500.100.	100	120	075	100	125	150	200	250	300	~ 1,93
3500.115.	115	135	075	100	125	150	200	250	300	~ 1,99
3500.125.	125	145	075	100	125	150	200	250	300	~ 2,03
3500.150.	150	170	075	100	125	150	200	250	300	~ 2,17
3500.175.	175	195	075	100	125	150	200	250	300	~ 2,28
3500.200.	200	220	075	100	125	150	200	250	300	~ 2,45
3500.225.	225	245	075	100	125	150	200	250	300	~ 2,59
3500.250.	250	270	075	100	125	150	200	250	300	~ 2,73

Supplement Part No. with required radius. Example: 3500.050.075.0

0 = standard color, other colors ▶ page 1.39 · Pitch = 67 mm/link - Links/m = 15



Internet: [www.igus.de](http://www.igus.de)  
E-mail: [info@igus.de](mailto:info@igus.de)

**Series 3450 - half E-Tube - snap-open along inner radius**

Part No.	Bi [mm]	Ba [mm]	R [mm]	Bending radii	Weight [kg/m]
3450.050.□.0	50	70	125	150 200 250 300	≈ 1,77
3450.075.□.0	75	95	125	150 200 250 300	≈ 1,95
3450.100.□.0	100	120	125	150 200 250 300	≈ 2,15
3450.115.□.0	115	135	125	150 200 250 300	≈ 2,30
3450.125.□.0	125	145	125	150 200 250 300	≈ 2,42
3450.150.□.0	150	170	125	150 200 250 300	≈ 2,60
3450.175.□.0	175	195	125	150 200 250 300	≈ 2,75
3450.200.□.0	200	220	125	150 200 250 300	≈ 2,90
3450.225.□.0	225	245	125	150 200 250 300	≈ 3,15
3450.250.□.0	250	270	125	150 200 250 300	≈ 3,30

The widths *Bi* / 50 / 125 / 150 / 200 / 225 / 250 are available upon request. Time of delivery approx. 6-8 weeks after order.

The bending radii **075** **100** are available upon request. Delivery time: approx. 6-8 weeks after receipt of order!

Supplement Part No. with required radius. Example: 3450.050.**125**.0

0 = standard color, other colors ▶ page 1.39 · Pitch = 67 mm/link - Links/m = 15



Please note: For using this series for long travels (gliding), please consult with igus® first. For long travels, igus® specifies E-Chains® that snap open on the outer radius.

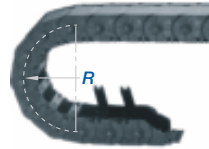
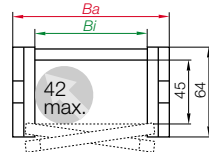

Part No. structure

3450.075.**125**.0



E2/000 medium  
Inner height: 45 mm

**Series 3480 - E-Tube - snap-open along inner radius**

Part No.	Bi [mm]	Ba [mm]	R [mm]	Bending radii	Weight [kg/m]
3480.050.□.0	50	70	125	150 200 250 300	≈ 1,96
3480.075.□.0	75	95	125	150 200 250 300	≈ 2,07
3480.100.□.0	100	120	125	150 200 250 300	≈ 2,30
3480.115.□.0	115	135	125	150 200 250 300	≈ 2,46
3480.125.□.0	125	145	125	150 200 250 300	≈ 2,49
3480.150.□.0	150	170	125	150 200 250 300	≈ 2,62
3480.175.□.0	175	195	125	150 200 250 300	≈ 2,80
3480.200.□.0	200	220	125	150 200 250 300	≈ 2,94
3480.225.□.0	225	245	125	150 200 250 300	≈ 3,12
3450.250.□.0	250	270	125	150 200 250 300	≈ 3,28

The widths *Bi* / 50 / 125 / 150 / 200 / 225 / 250 are available upon request. Time of delivery approx. 6-8 weeks after order.

The bending radii **075** **100** are available upon request. Delivery time: approx. 6-8 weeks after receipt of order!

Supplement Part No. with required radius. Example: 3480.075.**125**.0

0 = standard color, other colors ▶ page 1.39 · Pitch = 67 mm/link - Links/m = 15



Please note: For using this series for long travels (gliding), please consult with igus® first. For long travels, igus® specifies E-Chains® that snap open on the outer radius.

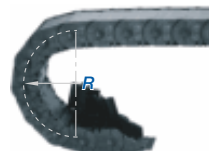
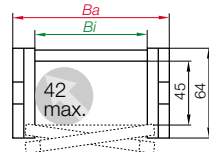

Part No. structure

3480.075.**150**.0



Phone +49- (0) 22 03-96 49-800  
Fax +49- (0) 22 03-96 49-222



▶ page 5.83



Vertical Separator	
unassembled	301
assembled	311



Spacer*	
unassembled	305.08
assembled	315.08
unassembled	305.12
assembled	315.12



Strain Relief Separator	
unassembled	301.Z
assembled	311.Z



\*For side-mounted applications

### Option 1: Vertical Separators and Spacer for E-Chains®

Vertical Separators are used if a vertical subdivision of the E-Chain® interior is required -

By standard Vertical Separators are assembled every other E-Chain® link

- **Standard** subdivision (Series 3400/Series 3500) with Vertical Separator 311, for combinations with Full-Width Shelf 2210.X
- If a broad distance shall be kept between the separators or they have to be fixed in their position, e.g. in case of side mounted applications, **Spacer 315.08** and **Spacer 315.12** can be used
- **Strain Relief Separator 301.Z**, integrable in the mounting bracket, to position at any point

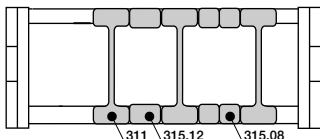

Vert. Separator, slotted	
unassembled	302
assembled	312



Vert. Separator, slotted	
unassembled	302.24
assembled	312.24



### Option 2: Full-Width Shelves for E-Chains®

For applications involving many thin cables with similar or identical diameters

- **Vertical Separator, slotted 312** and **Vertical Separator, slotted 312.24** (with wide base, e.g. in case of side mounted applications) - for applications with Full-Width Shelf 321.X

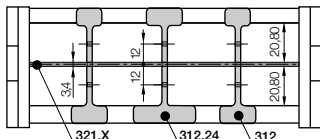

Width X [mm]	Part No. unassembled	Part No. assembled
50	320.050	321.050
75	320.075	321.075
100	320.100	321.100
115	320.115	321.115
125	320.125	321.125

Width X [mm]	Part No. unassembled	Part No. assembled
150	320.150	321.150
175	320.175	321.175
200	320.200	321.200
225	320.225	321.225
250	320.250	321.250

Full-Width Shelf	
X-1	
t = 3,4	

Side Plate	
unassembled	303
assembled	313



Middle Plate	
unassembled	304
assembled	314



Slotted Separator, open	
unassembled	307
assembled	317



### Option 3: Shelves for E-Chains®

For applications involving many cables with different diameters. The Shelves can be arranged elevator-shifted with different bottoms within the entire E-Chain® width

- **Shelf 2210.X** can be combined with **Middle Plate 314** and **Side Plate 313**
- Option 3 "Shelves" can also be combined with option 1 "Vertical Separators"
- Assembling of the **Slotted Separator, open 317** in the existing separation afterwards possible

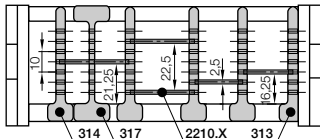

Width X [mm]	Part No. unassembled	Part No. assembled
18	2200.18	2210.18
23	2200.23	2210.23
28	2200.28	2210.28
33	2200.33	2210.33
38	2200.38	2210.38
43	2200.43	2210.43
48	2200.48	2210.48

Width X [mm]	Part No. unassembled	Part No. assembled
58	2200.58	2210.58
68	2200.68	2210.68
73	2200.73	2210.73
88	2200.88	2210.88
99	2200.99	2210.99
124	2200.124	2210.124
149	2200.149	2210.149

Shelf	
X	
X - 7	
t = 2,5	

### Option 4: Vertical Separators for E-Tubes

Vertical Separators are used if a vertical subdivision of the E-Tube interior is required -

By standard Vertical Separators are assembled every other E-Tube link

- Standard subdivision half E-Tube (Series 3450) and full E-Tube (Series 3480) with Vertical Separator 34511, for combinations with Full-Width Shelf 321.X
- Strain Relief Separator 34501.Z, integrable in the mounting bracket, to position at any point

Vert. Separator, slotted	unassembled	34501	
	assembled	34511	

Strain Relief Separator	unassembled	34501.Z	
	assembled	34511.Z	

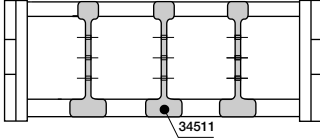

E2/000 medium  
Inner height: 45 mm

### Option 5: Full-Width Shelves for E-Tubes

For applications involving many thin cables with similar or identical diameters

- Vertical Separator, slotted 34511 - for applications with Full-Width Shelf 321.X

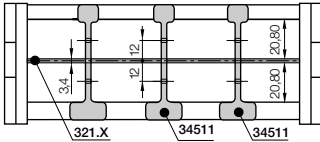

Width X [mm]	Part No. unassembled	Part No. assembled
50	320.050	321.050
75	320.075	321.075
100	320.100	321.100
115	320.115	321.115
125	320.125	321.125

Width X [mm]	Part No. unassembled	Part No. assembled
150	320.150	321.150
175	320.175	321.175
200	320.200	321.200
225	320.225	321.225
250	320.250	321.250

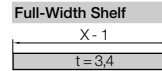

Phone +49- (0) 22 03-96 49-800  
Fax +49- (0) 22 03-96 49-222

### Option 6: Shelves for E-Tubes

For applications involving many cables with different diameters. The Shelves can be arranged elevator-shifted with different bottoms within the entire E-Chain® width

- Assembling of the Slotted Separator, open 317 in the existing separation afterwards possible
- Shelf 2210.X can be combined with Slotted Separator, open 317

Slotted Separator, open	unassembled	307	
	assembled	317	

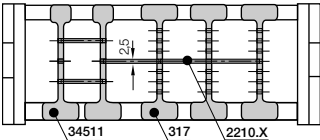

Width X [mm]	Part No. unassembled	Part No. assembled
18	2200.18	2210.18
23	2200.23	2210.23
28	2200.28	2210.28
33	2200.33	2210.33
38	2200.38	2210.38
43	2200.43	2210.43
48	2200.48	2210.48

Width X [mm]	Part No. unassembled	Part No. assembled
58	2200.58	2210.58
68	2200.68	2210.68
73	2200.73	2210.73
88	2200.88	2210.88
99	2200.99	2210.99
124	2200.124	2210.124
149	2200.149	2210.149

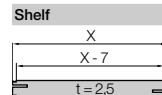

▶ page 5.83



Possible installation conditions for assembled mounting brackets ▶ Order example "preassembled" below

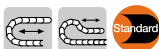

### The Standard - option polymer - pivoting

- Recommended for unsupported and gliding applications
- Well suited for tight installation conditions
- Strain relief with detachable tiewrap plates
- Variable traverse angle for flexible assembly
- The twistability of the E-Chain® and the option to assemble the mounting brackets on the fixed end and/or the moving end, enable various installation options

Moving end with bore  
(outer link) 3...3PZ(B)

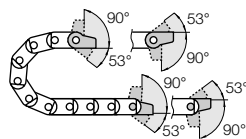

3...4PZ(B) Fixed end  
with pin (inner link)



Possible installation conditions for assembled mounting brackets ▶ Order example "preassembled" below

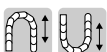

### Option polymer - locking

- Recommended for unsupported and gliding applications
- At very high speed and/or acceleration
- If space is limited for height (the  $H_F$  measurement)
- The twistability of the E-Chain® and the option to assemble the mounting brackets on the fixed end and/or the moving end, enable various installation options

Moving end with bore  
(outer link) 3...1PZ(B)

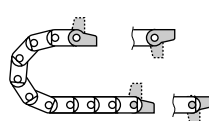

3...2PZ(B) Fixed end  
with pin (inner link)

## Dimensions and order configurations

Strain relief is possible on the moving end and/or the fixed end.

Part No. structure (pivoting)

3075. 34 PZB A1

A... must be indicated on preassembled configurations  
With assembled strain relief tiewrap plates  
Full set pivoting = 34  
Mounting brackets for selected chain type

Full set, for both ends:

3075. 34 PZB +tiewrap plate

Single-part order:

3075. 3 PZB +tiewrap plate

Mounting bracket with bore

3075. 4 PZB +tiewrap plate

Mounting bracket with pin

Part No. structure (locking)

3075. 12 PZB A1

A... must be indicated on preassembled configurations  
With assembled strain relief tiewrap plates  
Full set locking = 12  
Mounting brackets for selected chain type

Full set, for both ends:

3075. 12 PZB +tiewrap plate

Single-part order:

3075. 1 PZB +tiewrap plate

Mounting bracket with bore

3075. 2 PZB +tiewrap plate

Mounting bracket with pin

3...3PZ(B) Standard! (pivoting)

3...1PZ(B) (locking)

Moving end

Standard! (pivoting) 3...4PZ(B)

(locking) 3...2PZ(B)

Fixed end

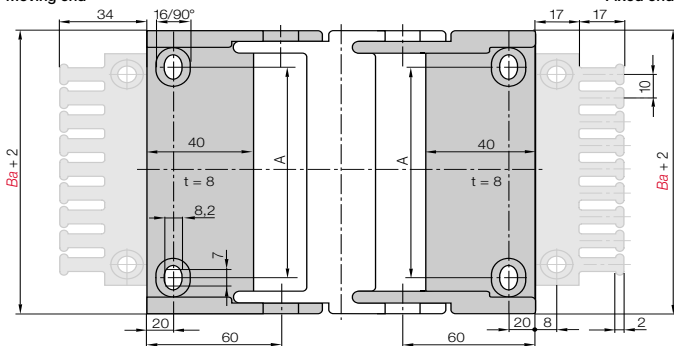

For E-Chain®	Part No. full set with tiewrap plate	Part No. with tiewrap plate + 10 cable tiewraps	Part No. full set without tiewrap plate	Dim. A [mm]
3400 - 3500.050	3050. PZB	3050. PZBK1	3050. PZ	28
3400 - 3500.075	3075. PZB	3075. PZBK1	3075. PZ	53
3400 - 3500.100	3100. PZB	3100. PZBK1	3100. PZ	78
3400 - 3500.115	3115. PZB	3115. PZBK1	3115. PZ	93
3400 - 3500.125	3125. PZB	3125. PZBK1	3125. PZ	103
3400 - 3500.150	3150. PZB	3150. PZBK1	3150. PZ	128
3400 - 3500.175	3175. PZB	3175. PZBK1	3175. PZ	153
3400 - 3500.200	3200. PZB	3200. PZBK1	3200. PZ	178
3400 - 3500.225	3225. PZB	3225. PZBK1	3225. PZ	203
3400 - 3500.250	3250. PZB	3250. PZBK1	3250. PZ	228

Please add the Part No. with the requested index - 34 for the pivoting configuration

e.g. 3075. 34 PZB or 12 for the locking configuration e.g. 3075. 12 PZB

For the preassembled mode please add the index A1...A4 e.g. 3075. 34 PZB A1





### Steel mounting bracket - pivoting

- Pivoting connections
- One part for all chain widths
- Electrically conductive
- Bolted connection outside of chain cross-section possible

Moving end with bore  
(outer link) 3000.1

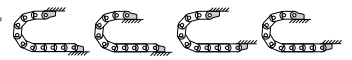
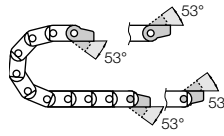

3000.2 Fixed end  
with pin (inner link)

Possible installation conditions -  
Further installation angles ► installation sketch

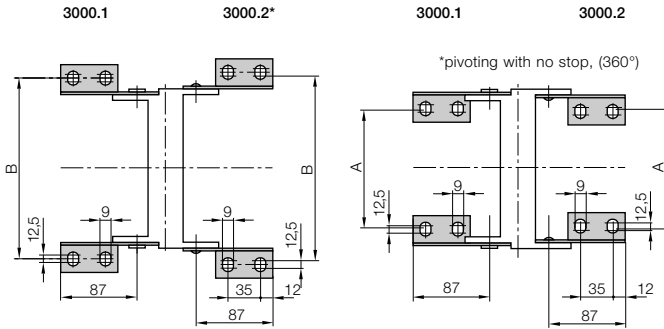

### Dimensions and order configurations

For E-Chain®	Part No. full set	Dim. A [mm]	Dim. B [mm]	Dim. C [mm]
3400 - 3500.050 ►	3000.12	28	86	97
3400 - 3500.075 ►	3000.12	53	111	122
3400 - 3500.100 ►	3000.12	78	136	147
3400 - 3500.115 ►	3000.12	93	151	162
3400 - 3500.125 ►	3000.12	103	161	172
3400 - 3500.150 ►	3000.12	128	186	197
3400 - 3500.175 ►	3000.12	153	212	224
3400 - 3500.200 ►	3000.12	178	236	247
3400 - 3500.225 ►	3000.12	203	261	272
3400 - 3500.250 ►	3000.12	228	286	297

3000.12 Full set, 4 parts  
2 with pin / 2 with bore

Single-part order:

3000.1 Mounting bracket

with bore, 1 part left / right

3000.2 Mounting bracket

with pin, 1 part left / right

Phone +49- (0) 22 03-96 49-800  
Fax +49- (0) 22 03-96 49-222



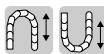

KMA = Polymer Metal  
Mounting Bracket

### Option KMA, locking for E-Chains® Series 3400 and Serie 3500

- Recommended for vertical hanging / standing applications
- Bolted connection outside of chain cross-section
- At very high speed and acceleration
- Universal mountable with attachment capability on all sides
- Stackable

Moving end with bore

Series 3400 = 34101...1

Series 3500 = 34101...1

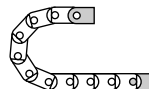

Series 3400 = 34101...2

Series 3500 = 34101...2

Fixed end with pin

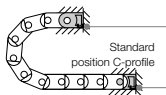

The attachment variants arising automatically by the choice of the KMA mounting bracket

### Dimensions and order configurations



Option KMA, pivoting  
for E-Chains® on request

Series 3400 = 34101...1

Series 3500 = 34101...1

Moving end  
ø 5,5

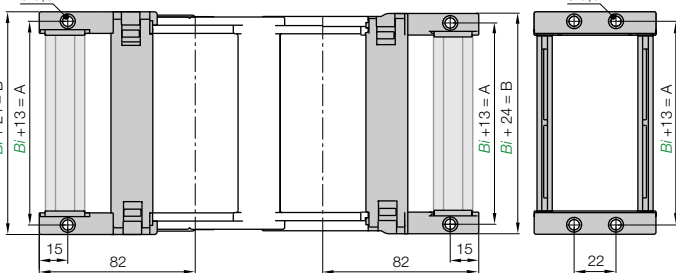

Part No. structure E-Chain®

34101.02.12.C.A

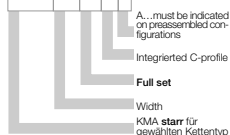

Full set, for both ends:

34101.02.12.C (with C-profile)

Bei Single-part order:

34101.02.1.C (with C-profile)

Mounting bracket with bore

34101.02.2.C (with C-profile)

Mounting bracket with pin

For E-Chain®	Part No. full set	Part No. full set	Dim. A [mm]	Dim B [mm]
Series 3400/3500	<b>with C-profile</b>	<b>without C-profile</b>		
3400/3500.050	34101.050.12.C	34101.050.12	63	74
3400/3500.075	34101.075.12.C	34101.075.12	88	99
3400/3500.100	34101.100.12.C	34101.100.12	113	124
3400/3500.115	34101.115.12.C	34101.115.12	128	139
3400/3500.125	34101.125.12.C	34101.125.12	138	149
3400/3500.150	34101.150.12.C	34101.150.12	163	174
3400/3500.175	34101.175.12.C	34101.175.12	188	199
3400/3500.200	34101.200.12.C	34101.200.12	213	224
3400/3500.225	34101.225.12.C	34101.225.12	238	249
3400/3500.250	34101.250.12.C	34101.250.12	263	274

For the preassembled mode please add the index A e.g. 34101.02.12.A

Phone +49- (0) 22 03-96 49-800  
Fax +49- (0) 22 03-96 49-222

igus® GmbH  
51147 Cologne

Internet: www.igus.de  
E-mail: info@igus.de

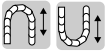

KMA = Polymer Metal Mounting Bracket

**Option KMA, locking for half E-Tubes Series 3450**  
**Option KMA, locking for full E-Tubes Series 3480**

- Recommended for vertical hanging / standing applications
- Bolted connection outside of chain cross-section
- At very high speed and acceleration
- Universal mountable with attachment capability on all sides
- Stackable

**Moving end with bore**

Series 3450 = **34510...1**

Series 3480 = **34810...1**

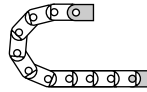

Series 3450 = **34510...2**

Series 3480 = **34810...2**

**Fixed end with pin**



The attachment variants arising automatically by the choice of the KMA mounting bracket

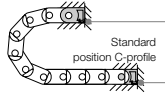

Standard position C-profile

Series 3450 = **34510...1**

Series 3480 = **34810...1**

**Moving end**

ø 5,5

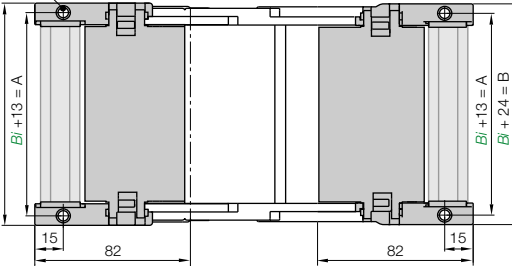

Series 3450 = **34510...2**

Series 3480 = **34810...2**

**Fixed end**

ø 5,5

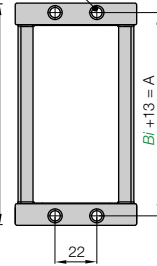

**Dimensions and order configurations**



**Option KMA, pivoting for half E-Tubes and full E-Tubes on request**

For E-Chain®	Part No. full set	Part No. full set	Dim. A [mm]	Dim B [mm]
	<b>with C-profile</b>	<b>without C-profile</b>		
Series 3450				
3450.050	34510.050.12.C	34510.050.12	63	74
3450.075	34510.075.12.C	34510.075.12	88	99
3450.100	34510.100.12.C	34510.100.12	113	124
3450.115	34510.115.12.C	34510.115.12	128	139
3450.125	34510.125.12.C	34510.125.12	138	149
3450.150	34510.150.12.C	34510.150.12	163	174
3450.175	34510.175.12.C	34510.175.12	188	199
3450.200	34510.200.12.C	34510.200.12	213	224
3450.225	34510.225.12.C	34510.225.12	238	249
3450.250	34510.250.12.C	34510.250.12	263	274

For the **preassembled** mode please add the index **A** e.g. **34510.02.12.A**

For E-Chain®	Part No. full set	Part No. full set	Dim. A [mm]	Dim B [mm]
	<b>with C-profile</b>	<b>without C-profile</b>		
Series 3480				
3480.050	34810.050.12.C	34810.050.12	63	74
3480.075	34810.075.12.C	34810.075.12	88	99
3480.100	34510.100.12.C	34510.100.12	113	124
3480.115	34810.115.12.C	34810.115.12	128	139
3480.125	34810.125.12.C	34810.125.12	138	149
3480.150	34810.150.12.C	34810.150.12	163	174
3480.175	34810.175.12.C	34810.175.12	188	199
3480.200	34810.200.12.C	34810.200.12	213	224
3450.225	34810.225.12.C	34810.225.12	238	249
3450.250	34810.250.12.C	34810.250.12	263	274

For the **preassembled** mode please add the index **A** e.g. **34810.02.12.A**

**Part No. structure half E-Tube**

34510.02.12.C A

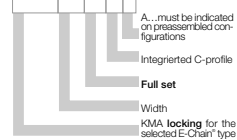

A... must be indicated on preassembled configurations

Integrated C-profile

Full set

113

Width

KMA locking for the selected E-Chain® type

**Full set, for both ends:**

**34510.02.12.C** (with C-profile)

**Bei Single-part order:**

**34510.02.1.C** (with C-profile)

Mounting bracket **with bore**

**34510.02.2.C** (with C-profile)

Mounting bracket **with pin**

**Part No. structure full E-Tube**

34810.02.12.C A

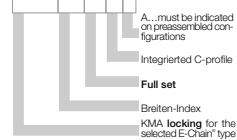

A... must be indicated on preassembled configurations

Integrated C-profile

Full set

Breitex-Index

KMA locking for the selected E-Chain® type

**Full set, for both ends:**

**34810.02.12.C** (with C-profile)

**Bei Single-part order:**

**34810.02.12.C** (with C-profile)

Mounting bracket **with bore**

**34810.02.12.C** (with C-profile)

Mounting bracket **with pin**

Phone +49- (0) 22 03-96 49-800  
Fax +49- (0) 22 03-96 49-222



▶ page 5.83



### Tiewrap plate as individual part

As individual component screwed on KMA. Can be plugged in the mounting brackets. **Details ▶ chapter 10**

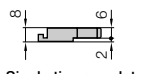

Single tie-strap plate

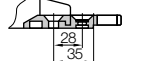

Shown assembled

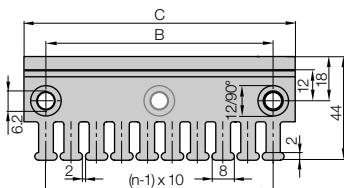

Tiewrap plate	No. of teeth <i>n</i>	Dim. C [mm]	Dim. B [mm]
3050.ZB	5	50	30
3075.ZB	7	75	55
3100.ZB	10	100	80
3115.ZB	11	115	95
3125.ZB	12	125	105
3150.ZB	15	150	130
3175.ZB	17	175	155
3200.ZB	20	200	180
3225.ZB	22	225	205
3250.ZB	25	250	230

(- = no / + = yes)



### Cable tie-wraps as individual part

Cable tie-wraps (100-piece bag)	Width x length	max. Ø	Tensile strength
CFB.001	4,8 x 150 mm	36 mm	222 N



### "Double" strain relief

If an E-Chain® is harnessed with a very large number of cables, strain relief may be necessary at two levels. Our 30XX.Z and 30XX.ZS strain relief system was developed for this purpose. It can be placed in any position along the E-Chain®. As required, the 30XX.Z and 30XX.ZS strain relief system is simply clamped onto the crossbar of the chain link. No additional installation elements are needed. **Details ▶ chapter 10**

Art. Nr. crossbar (fixed)	Width [mm]	No. of teeth
3050.Z*	50	5
3075.Z*	74	7

Art. Nr. crossbar (openable)	Width [mm]	No. of teeth
3035.ZS**	35	3
3050.ZS**	50	5
3075.ZS**	75	7

\*not für Series 3450 and 3480 \*\*not für Series 3480

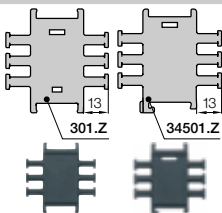

### Strain relief separator

Separator with integrated strain relief, for use in the first or last chain link. For manufacturing of switchgear cabinets or for the assembly of machines. Easy to assemble without any fastening device. Separator base 2020.Z is 18 mm and 34501.Z is 14 mm wide. The possible number of separators per E-Chain® is defined by its inner width *B<sub>i</sub>* and by the cable-diameter. **Details ▶ chapter 10**

Part No.	Number of teeth	For Series
301.Z	3 both sides	3400/3500 E-Chain®
34501.Z	3 both sides	3450/3480 E-Tube



### Strain relief for steel mounting brackets

Clip-on connection is not possible with steel mounting brackets. In this case, the tie-strap plates must be bolted directly into separate bore holes in front of the mounting bracket. Alternatively the tie-strap plates 30XX.Z and ZS can be also used here. **Details ▶ chapter 10**

### Chainfix strain relief C-profile-solutions - more Details ▶ chapter 10



Other strain relief elements - optional ▶ chapter 10



Chainfix clamps made of steel or stainless steel



Chainfix Clips - modular, snap-on



Chainfix Nugget with pre-harnessed cable strap

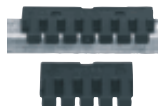

Chainfix - tie-strap plates with clip-on connection

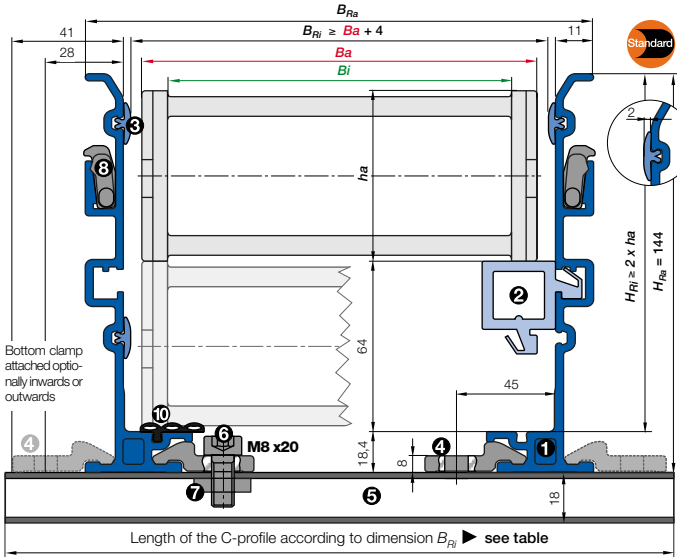

- $Ba$  = Outer width E-Chains® / E-Tube
  - $Bi$  = Inner width E-Chains® / E-Tube
  - $ha$  = Outer height E-Chains® / E-Tube
  - $H_{Ri}$  = Inner trough height
  - $H_{Ra}$  = Outer trough height
  - $B_{Ri}$  = Inner trough width ▶ depends on dim.  $Ba$
  - $B_{Ra}$  = Outer trough width
  - $n_{Mon}$  = Number of installation sets (left/right)
  - $n_{Ri}$  = Number of trough sets (left/right)
- $H_{Ri} \geq 2 \cdot ha$   
 $B_{Ri} \geq Ba + 4$
- = Guide trough set
  - = Installation set "Basic"
  - = C-Profile
  - = Glide bar

**Installation set "Basic" with C-Profile**

Bottom Clamp attached optionally inwards or outwards ▶

3500.075.200.0 ▶ Order example

$B_{Ri}$ [mm]	Part No.	
	attached inwards	attached outwards
.050	74	960.40.200
.075	99	960.40.225
.100	124	960.40.175 960.40.250
.115	139	960.40.200 960.40.275
.125	149	960.40.200 960.40.275
.150	174	960.40.225 960.40.300
.175	199	960.40.250 960.40.325
.200	224	960.40.275 960.40.350
.225	249	960.40.300 960.40.375
.250	274	960.40.325 960.40.400

Insert for the installation set "Heavy-Duty": **973.50,XXX** instead of (960.40,XXX) on the right column "attached outwards"



- **Components, trough "Basic":** ① Trough side parts, aluminum, 2 m ② Glide bar, plastic, 2 m ③ Glide strips, plastic, 2 m (without glide strips on request) ⑩ Optional: Silencer profile, rubber
- **Components, installation set "Basic":** ④ Bottom clamp, aluminum ⑤ C-profile, steel galvanized ⑥ Screw M6 x16 ⑦ Sliding nut M6 ⑧ Interface connector, plastic

**Order example: Length of travel 30 m - Center mounted for Series 3500.100.200.0 with  $B_{Ri} = 124$**

Guide trough set (set of 2 trough side parts, incl. glide strips) <b>without</b> glide bar	Part No.	973.30.SL
Order text: 16 m guide trough without glide bar (8 x 2 m sections)		
Guide trough set (set of 2 trough side parts, incl. glide strips) <b>with</b> glide bar	Part No.	973.31.SL
Order text: 16 m guide trough with glide bar (8 x 2 m sections)		
Installation set "Basic" complete (guide trough-sets + 1)	Part No.	960.40.175
Order text: 17 installation sets "Basic"		
Module for the fixed end	Part No.	973.80
Order text: 1 set		
Option: For an additional noise dampening with silencer profile, please add Index A - Example:	Part No.	973.30.SLA

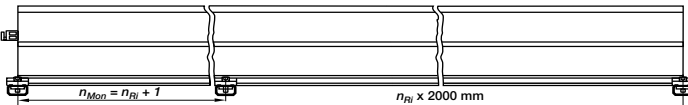

Principle sketch: Number of installation sets to be installed = **Number of trough sections + 1**

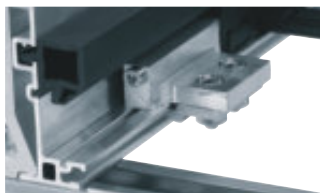

**New!** A quick fix for mounting the stationary end of an E-Chain®

- With this new module for the fixed end, fast and easy mounting onto the Aluminum "SuperTrough" is now possible without any drilling. Fast mounting of the E-Chain® by clamping onto the aluminum trough
- Quick relocation of the stationary end
  - No drilling necessary

Phone +49- (0) 22 03-96 49-800  
 Fax +49- (0) 22 03-96 49-222



▶ page 5.83

● ● ● Price index



IPA Qualification Certificate Air  
Cleanless Class ISO Class 3  
(at  $v = 2 \text{ m/s}$ ) upon request



ESD classification:  
Electrically conductive ESD/ATEX  
version upon request



UL94 V2 classifications  
upon request

- ❶ Snap-open, hinged to left or right, accessible from the top
- ❷ Lateral glide surfaces for side-mounted operation
- ❸ Large pins for long service life
- ❹ Introduction bevel – easy assembly
- ❺ Small pitch for very quiet operation
- ❻ Integrated strain relief possible
- ❼ Smooth interior for long cable life
- ❽ Dirt-repellent exterior
- ❾ Modular interior separation

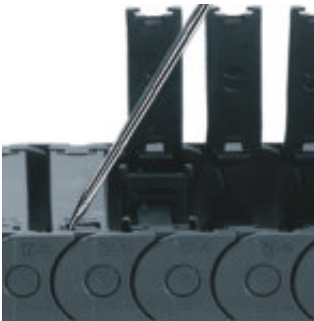

1. To open crossbars press screwdriver into tab on top of link, lever screwdriver until crossbar opens. 2. Repeat step 1 on other side.



When to use the Series 255:

- If quieter operation at very high speeds is required
- If integrated strain relief is required at the connection point
- If modular interior separation required
- If easy installation is required



When not to use it:

- If each link requires snap-open accessibility on both sides
  - ▶ System E4, Series 210, page 7.12
- If maximum stability is required
  - ▶ System E4, Series 210, page 7.12
- If the application is very simple
  - ▶ Easy Chain®, Series E200, page 3.36

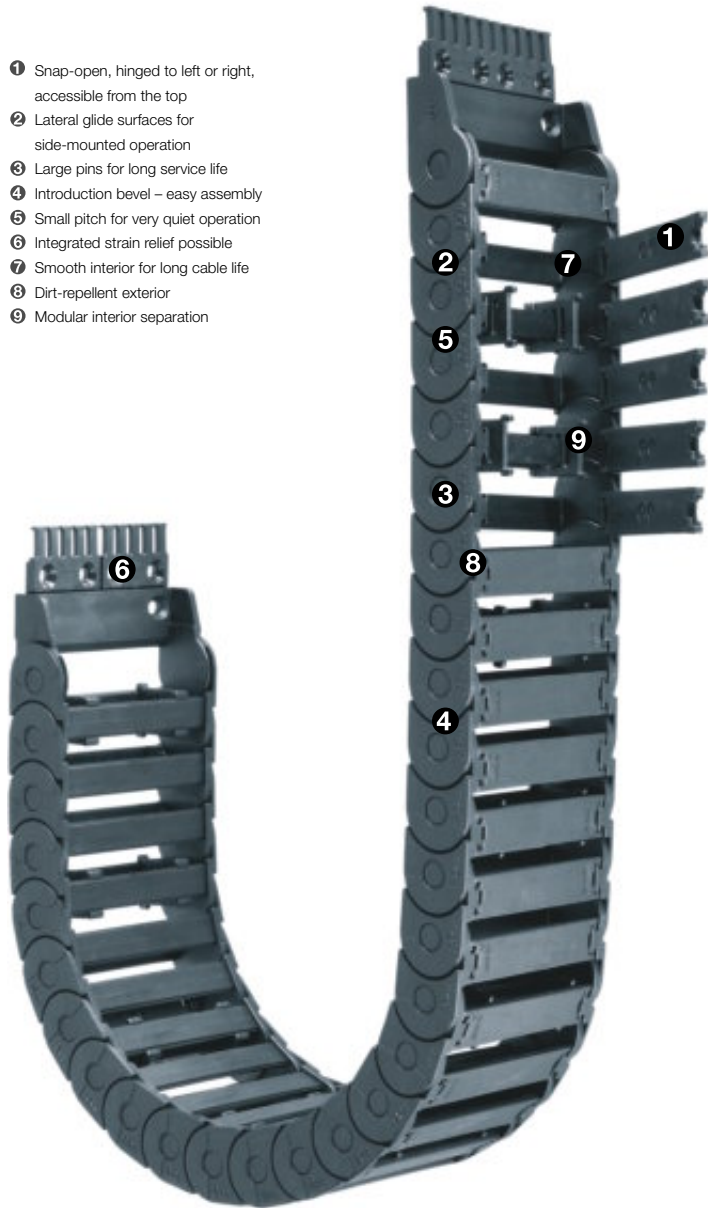

Order example complete E-Chain®

Please indicate chain-lengths or number of links Example: 2 m or 72 links

2 m 255.10.100.0

E-Chain®

with 2 separators 2552 assembled every 2<sup>nd</sup> link

Interior separation

1 set 2100.34PZ1B

Mounting bracket

**Unsupported length**

$FL_G$  = with straight upper run

$FL_B$  = with permitted sag

Further information ► **Design, page 1.12**

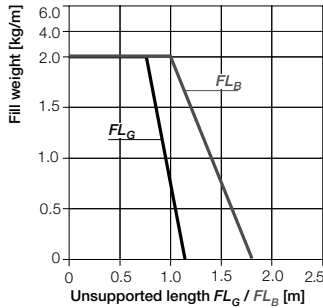
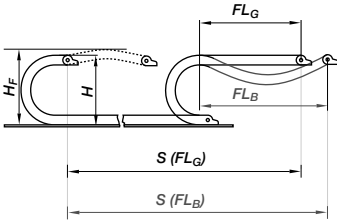

- $S$  = Length of travel
  - $R$  = Turning radius
  - $H$  = Nominal clearance height
  - $H_F$  = Required clearance height
  - $H_{in}$  = Trough inner height
  - $D$  = Overlength E-Chain® radius in final position
  - $K = \pi \cdot R + \text{"safety"}$
  - $D_2$  = Overlength - long travels, gliding
  - $K_2$  = \*Further add-on
  - $H_2$  = \*Mounting height
- \*if the mounting bracket location is set lower

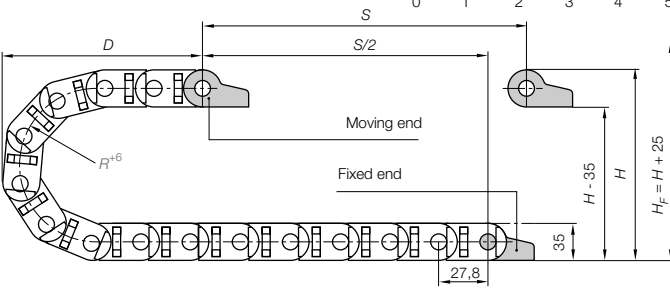

**Pitch = 27,8 mm/link    Links/m = 36 (1000,8 mm)    Chain length =  $S/2 + K$**

R	055	075	100	125	150	175	200	225	250
$H + H_0$	145	185	235	285	335	385	435	485	535
D	108	133	153	178	203	228	253	278	303
K	242	312	380	462	544	626	708	780	886
$D_2 + 25$	-	-	380	495	570	665	740	1040	1130
$K_2$	-	-	612	806	945	1112	1223	1610	1779
$H_2$	-	-	100	100	100	100	100	100	100

**Other installation methods**

- Vertical, hanging  $\leq 40$  m
- Vertical, standing  $\leq 3$  m
- Side mounted, un supp.  $\leq 1$  m
- Rotary requires further calculation
- Unsupported length of upper run = upon request

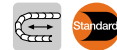

**Short travels - unsupported**

Unsupported E-Chains® feature positive camber over short travels. This must be accounted for when specifying the clearance height  $H_F$ . Please consult igus® if space is particularly restricted.

The required clearance height:  
 **$H_F = H + 25$  mm**  
 (with 1,5 kg/m fill weight)

**Long travel lengths from 10 m to max. 100 m    Chain length =  $S/2 + K_2$**

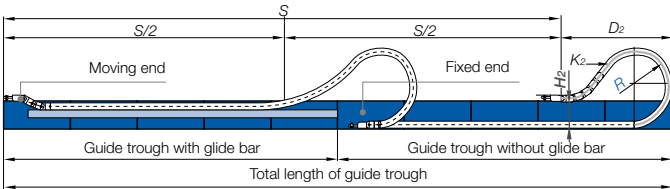

In case of travels between 4 and 10 m we recommend a longer unsupported length.



**Gliding, long travel applications (max. 100 m)**

In this case the E-Chain® upper run will be introduced in a guide trough on the lower run. We recommend to realize the engineering of such a plant by our technicians.

Speed / acceleration $FL_G$	max. 20 [m/s] / max. 200 [m/s²]
Speed / acceleration $FL_B$	max. 3 [m/s] / max. 6 [m/s²]
Gliding speed / acceleration (maximum)	max. 10 [m/s] / max. 50 [m/s²]
Material - permitted temperature °C	igumid G / -40° up to +130° C
Flammability class, igumid G	VDE 0304 IIC UL94 HB

**Technical Data**



Details of material properties  
 ► page 1.38



**E2 medium**  
**Inner height: 24 mm**

**Tel. +49- (0) 22 03-96 49-800**  
**Fax +49- (0) 22 03-96 49-222**

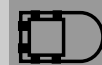

► page 5.83



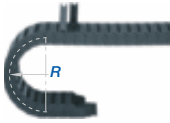
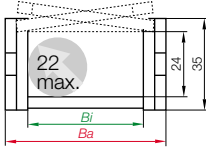

Part No. structure

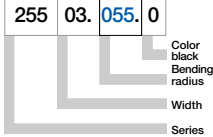

Series 255 - snap-open along outer radius

Part No.	Bi [mm]	Ba [mm]	R [mm]	Bending radii										Weight [kg/m]
255.03.□.0	38	54	055	075	100	125	150	175	200	225	250	~ 0,81		
255.05.□.0	57	73	055	075	100	125	150	175	200	225	250	~ 0,90		
255.07.□.0	77	93	055	075	100	125	150	175	200	225	250	~ 1,01		
255.10.□.0	103	119	055	075	100	125	150	175	200	225	250	~ 1,15		

Supplement Part No. with required radius. Example: 255.03.055□.0

0 = standard color, other colors ▶ page 1.39 - Pitch = 27,8 mm/link - Links/m = 36



Series 255 - small pitch, smooth running - test-example at the igus® test lab

### Option 1: Vertical Separators

Vertical Separators are used if a vertical subdivision of the E-Chain® interior is required -

By standard Vertical Separators are assembled every other E-Chain® link

- Standard subdivision with Vertical Separator, slotted 2552 or Vertical Separator, slotted 2554 for combinations with Full-Width Shelf 221.X (Determining which type of separator to use is dependent on any potential retrofit requirements.)

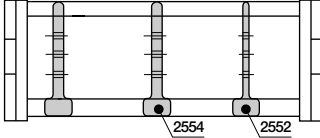

Vert. Separator, slotted	
unassembled	2551
assembled	2552



Vert. Separator, slotted	
unassembled	2553
assembled	2554



E2 medium  
Inner height: 24 mm

### Option 2: Full-Width Shelves

For applications involving many thin cables with similar or identical diameters

- Vertical Separator, slotted 2552 oder Vertical Separator, slotted 2554 - for applications with Full-Width Shelf 221.X

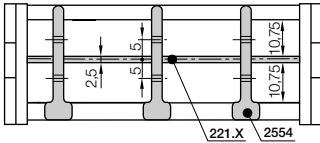

Width X [mm]	Part No. unassembled	Part No. assembled
38	220.38	221.38
57	220.57	221.57

Width X [mm]	Part No. unassembled	Part No. assembled
77	220.77	221.77
103	220.103	221.103

Full-Width Shelf

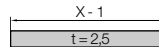

Phone +49- (0) 22 03-96 49-800  
Fax +49- (0) 22 03-96 49-222

### Option 3: Shelves

For applications involving many cables with similar or identical diameters. Partial separation into individual chambers can be achieved and the entire width B/-10 mm can be used

- Shelf 2210.X can be combined with Vertical Separator, slotted 2552 (also as adjustable vertical separators without shelves) or Vertical Separator, slotted 2554
- Option 3 "Shelves" can also be combined with option 1 "Vertical Separators".

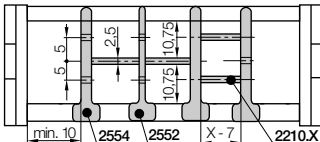

Width X [mm]	Part No. unassembled	Part No. assembled
18	2200.18	2210.18
23	2200.23	2210.23
28	2200.28	2210.28
33	2200.33	2210.33
38	2200.38	2210.38
43	2200.43	2210.43

Width X [mm]	Part No. unassembled	Part No. assembled
48	2200.48	2210.48
58	2200.58	2210.58
68	2200.68	2210.68
73	2200.73	2210.73
88	2200.88	2210.88

Shelf

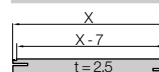

▶ page 5.83

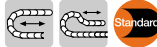

### The Standard - option polymer - pivoting

- Recommended for unsupported and gliding applications
- Well suited for tight installation conditions
- Strain relief with detachable tiwrap plates
- Variable traverse angle for flexible assembly
- The twistability of the E-Chain® and the option to assemble the mounting brackets on the fixed end and/or the moving end, enable various installation options

Moving end with bore (outer link) 2...3PZ1(B)

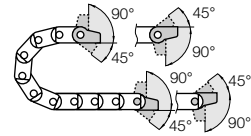

2...4PZ1(B) Fixed end with pin (inner link)

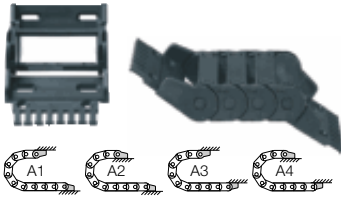

Possible installation conditions for assembled mounting brackets ▶ Order example "preassembled" below

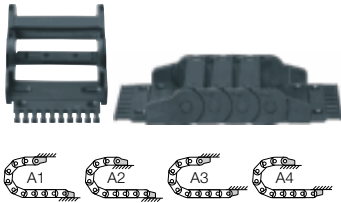

Possible installation conditions for assembled mounting brackets ▶ Order example "preassembled" below

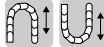

### Option polymer - locking

- Recommended for unsupported and gliding applications
- At very high speed and/or acceleration
- If space is limited for height (the  $H_F$  measurement)
- The twistability of the E-Chain® and the option to assemble the mounting brackets on the fixed end and/or the moving end, enable various installation options

Moving end with bore (outer link) 2...1PZ1(B)

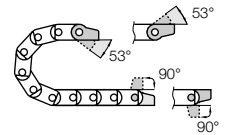

2...2PZ1(B) Fixed end with pin (inner link)

## Dimensions and order configurations

Strain relief is possible on the moving end and/or the fixed end.

### Part No. structure (pivoting)

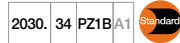

A... must be indicated on preassembled configurations  
With assembled strain relief tiwrap plates  
Full set pivoting = 34  
Mounting brackets for selected chain type

### Full set, for both ends:

2030. 34 PZ1B +tiwrap plate

### Single-part order:

2030. 3 PZ1B +tiwrap plate

Mounting bracket with bore

2030. 4 PZ1B +tiwrap plate

Mounting bracket with pin

### Part No. structure (locking)

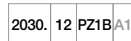

A... must be indicated on preassembled configurations  
With assembled strain relief tiwrap plates  
Full set locking = 12  
Mounting brackets for selected chain type

### Full set, for both ends:

2030. 12 PZ1B +tiwrap plate

### Single-part order:

2030. 1 PZ1B +tiwrap plate

Mounting bracket with bore

2030. 2 PZ1B +tiwrap plate

Mounting bracket with pin

### 2...3PZ1(B) Standard! (pivoting)

### 2...1PZ1(B) (locking)

### Moving end

### Standard! (pivoting) 2...4PZ1(B)

### (locking) 2...2PZ1(B)

### Fixed end

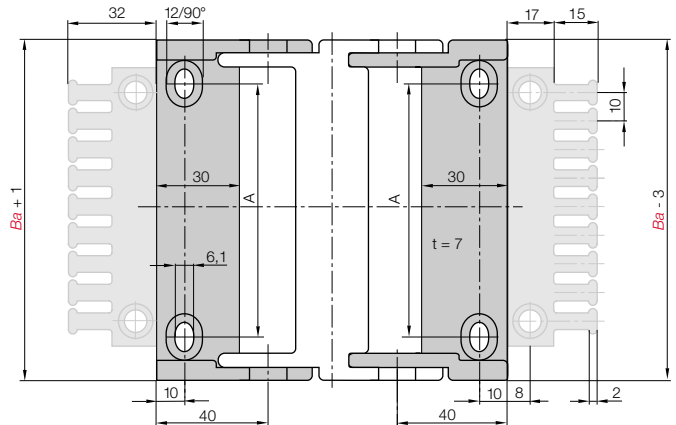

For	Part No.	Part No. with	Part No.	Dim. A
E-Chain®	full set with	tiwrap plate +	full set without	[mm]
	tiwrap plate	10 cable tiwraps	tiwrap plate	
255.03 ▶	2030. <input type="text"/> PZ1B	2030. <input type="text"/> PZ1BK1	2030. <input type="text"/> PZ1	25
255.05 ▶	2050. <input type="text"/> PZ1B	2050. <input type="text"/> PZ1BK1	2050. <input type="text"/> PZ1	44
255.07 ▶	2070. <input type="text"/> PZ1B	2070. <input type="text"/> PZ1BK1	2070. <input type="text"/> PZ1	64
255.10 ▶	2100. <input type="text"/> PZ1B	2100. <input type="text"/> PZ1BK1	2100. <input type="text"/> PZ1	90

Please add the Part No. with the requested index - 34 for the pivoting configuration

e.g. 2030. 34 PZ1B or 12 for the locking configuration e.g. 2030. 12 PZ1B

For the preassembled mode please add the index A1...A4 e.g. 2030. 34 PZ1B A1

igus® GmbH  
51147 Cologne

Internet: www.igus.de  
E-mail: info@igus.de

**Strain Relief for polymer mounting brackets (pivoting or locking)**

The strain relief plates can be snapped directly onto the mounting bracket without additional hardware. When the mounting brackets are bolted into place, the strain relief plates are also firmly connected to the machine surface. No separate installation is necessary. Cable tieswraps secure cables using the "teeth" of the tiewrap plate for time-saving, effective strain relief. **Details ▶ chapter 10**



Tiewrap plate	No. of teeth <i>n</i>	Dim. C [mm]	Dim. B [mm]
2020.ZB	3	30	15
2030.ZB	4	40	20
2040.ZB	5	50	30
2050.ZB	6	60	40
2070.ZB	8	80	60
2090.ZB = (2030.ZB + 2040.ZB)	9	90	-
2100.ZB	10	100	80
2125.ZB = (2050.ZB + 2050.ZB)	12	120	-

**Tiewrap plate as individual part**

As individual component screwed on KMA. Can be plugged in the mounting brackets. **Details ▶ chapter 10**

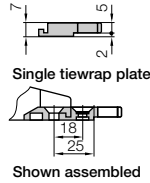
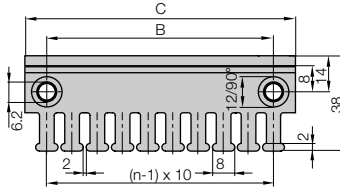

**Cable tieswraps as individual part**

Cable tieswraps (100-piece bag)	Width x length	max. Ø	Tensile strength
CFB.001	4,8 x 150 mm	36 mm	222 N



Other strain relief elements - optional ▶ chapter 10

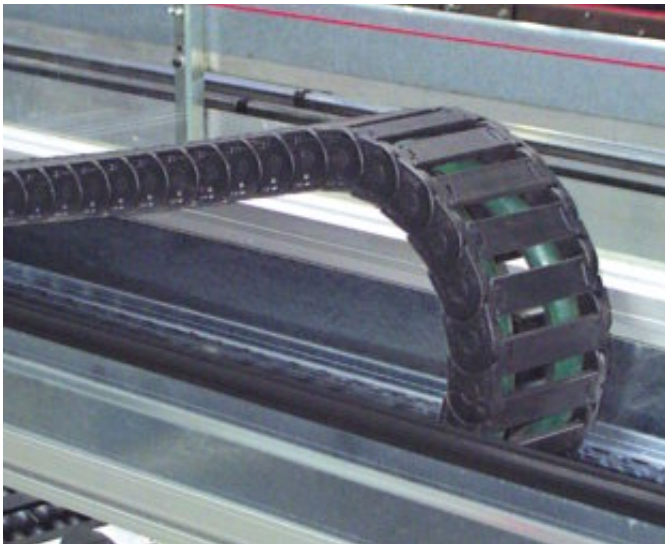

Series 255 - also for long travel application

E2 medium  
Inner height: 24 mm

Phone +49- (0) 22 03-96 49-800  
Fax +49- (0) 22 03-96 49-222



▶ chapter 10



▶ page 5.83

- Ba** = Outer width E-Chains® / E-Tube
- Bi** = Inner width E-Chains® / E-Tube
- ha** = Outer height E-Chains® / E-Tube
- H<sub>Ri</sub>** = Inner trough height
- H<sub>Ra</sub>** = Outer trough height
- B<sub>Ri</sub>** = Inner trough width ▶ depends on dim. Ba
- B<sub>Ra</sub>** = Outer trough width
- n<sub>Mon</sub>** = Number of installation sets (left/right)
- n<sub>Ri</sub>** = Number of trough sets (left/right)
- H<sub>Ri</sub> ≥ 2 • ha**
- B<sub>Ri</sub> ≥ Ba + 4**
- = Guide trough set      ● = Glide bar
- = Installation set "Basic"      ● = C-Profile

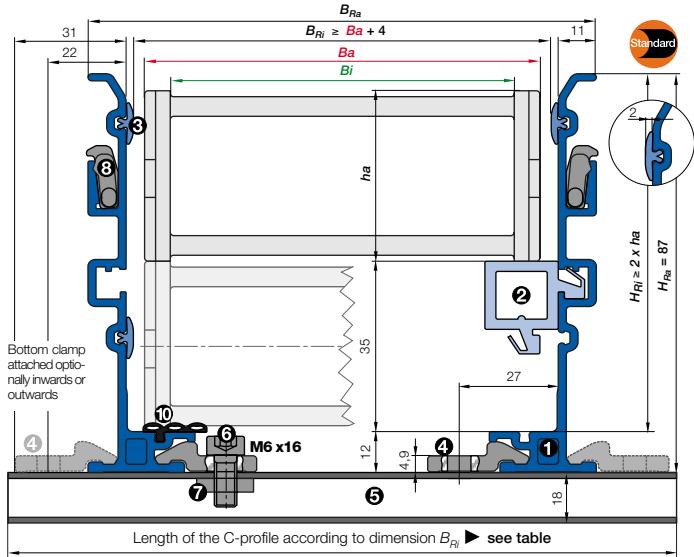

Phone +49- (0) 22 03-96 49-800  
 Fax +49- (0) 22 03-96 49-222

**Installation set "Basic" with C-Profile**

Bottom Clamp attached optionally inwards or outwards

255.05.200.0 ▶ Order example

	Part No.	Part No.
B <sub>Ri</sub> attached [mm]	attached inwards	attached outwards
.03 58	-	960.30.150
.05 77	960.30.125	960.30.175
.07 97	960.30.150	960.30.200
.10 123	960.30.175	960.30.225

"Heavy-Duty": **971.50.XXX**  
 instead of ( 960.30.XXX) on the right column "attached outwards"

igus® GmbH  
 51147 Cologne



- **Components, trough "Basic":** ① Trough side parts, aluminum, 2 m ② Glide bar, plastic, 2 m ③ Glide strips, plastic, 2 m (without glide strips on request) ⑩ Optional: Silencer profile, rubber
- **Components, installation set "Basic":** ④ Bottom clamp, aluminum ⑤ C-profile, steel galvanized ⑥ Screw M6 x16 ⑦ Sliding nut M6 ⑧ Interface connector, plastic



**Order example: Length of travel 30 m - Center mounted for Series 255.05.200.0 with B<sub>Ri</sub> = 77**

Guide trough set (set of 2 trough side parts, incl. glide strips) <b>without</b> glide bar	<b>Part No.</b>	<b>971.30.SL</b>
<b>Order text:</b> 16 m guide trough without glide bar (8 x 2 m sections)		
Guide trough set (set of 2 trough side parts, incl. glide strips) <b>with</b> glide bar	<b>Part No.</b>	<b>971.31.SL</b>
<b>Order text:</b> 16 m guide trough with glide bar (8 x 2 m sections)		
Installation set "Basic" complete (guide trough-sets + 1)	<b>Part No.</b>	<b>960.30.150</b>
<b>Order text:</b> 17 installation sets "Basic"		
Module for the fixed end	<b>Part No.</b>	<b>971.80</b>
<b>Order text:</b> 1 set		
<b>Option:</b> For an additional noise dampening with silencer profile, please add Index A - Example:	<b>Part No.</b>	<b>971.30.SLA</b>

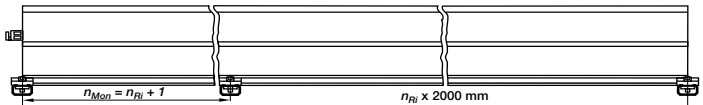

Principle sketch: Number of installation sets to be installed = **Number of trough sections + 1**

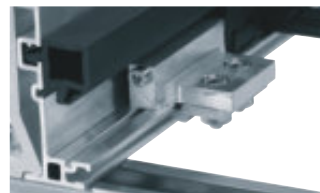

**New! A quick fix for mounting the stationary end of an E-Chain®**

With this new module for the fixed end, fast and easy mounting onto the Aluminum "SuperTrough" is now possible without any drilling. Fast mounting of the E-Chain® by clamping onto the aluminum trough

- Quick relocation of the stationary end
- No drilling necessary

Internet: [www.igus.de](http://www.igus.de)  
 E-mail: [info@igus.de](mailto:info@igus.de)

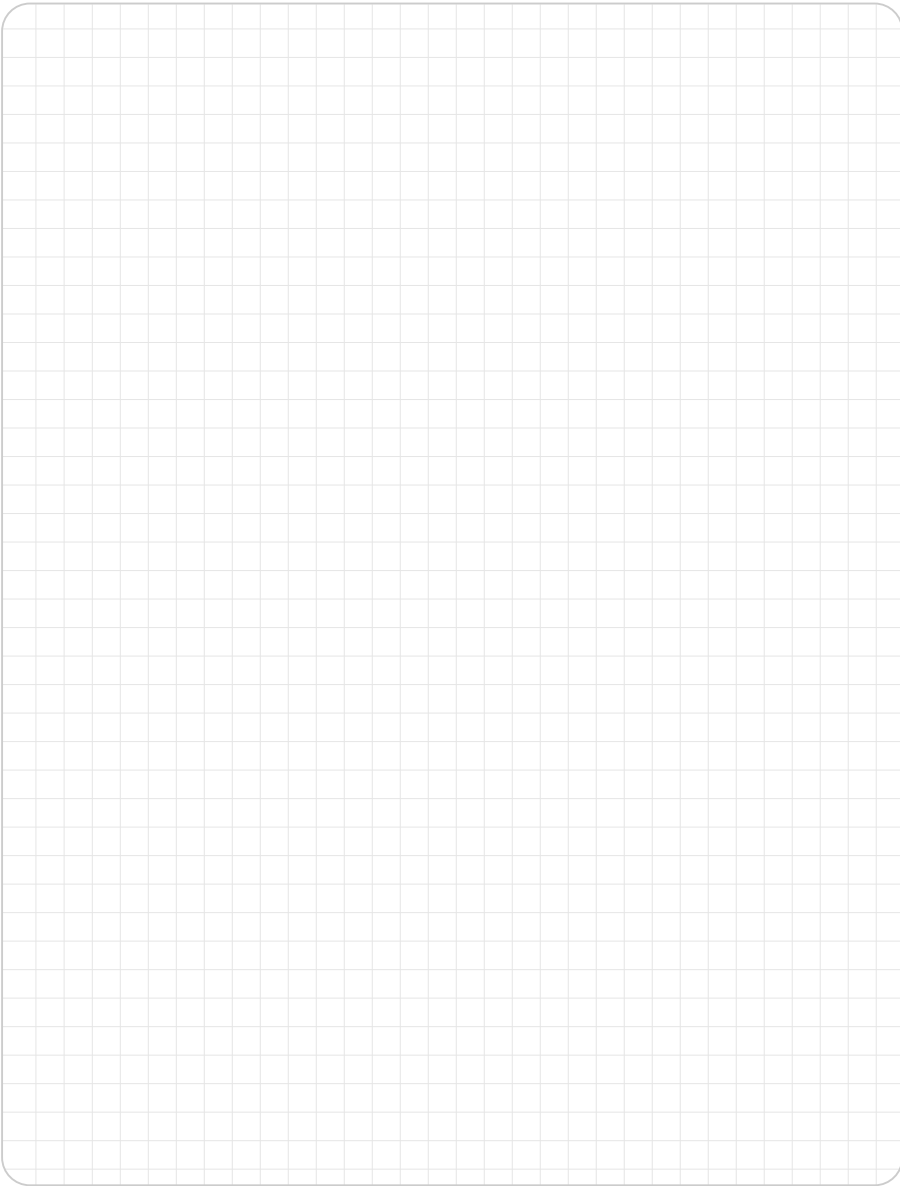

E2 medium  
Inner height: 24 mm

Phone +49- (0) 22 03-96 49-800  
Fax +49- (0) 22 03-96 49-222



chapter 9



page 5.83

## High EMC with braided copper shield - Chainflex® CF31

PVC outer jacket, oil-proof in accordance with VDE, flame-retardant, shielded  
Further information: [www.igus.de/en/CF31](http://www.igus.de/en/CF31)

TIP!

IGUS® CHAINFLEX® CF31



# E2 E-Tubes





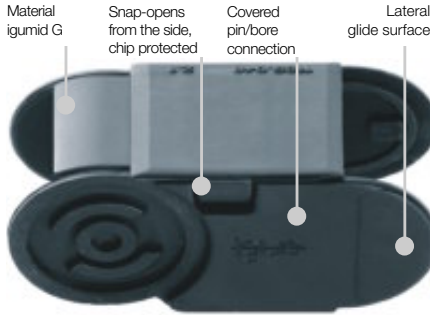

## E2 Series R100 - robust and tight

- Very good protection against chips (also hot chips)
- Hinged, snap-open, removable lids along inner and outer radius reduce assembly time
- Space-efficient with optimized ratio of inner dimension to outer dimension
- Double stop dog for long service life and strong unsupported lengths
- Universal KMA mounting brackets with attachment capability on all sides
- You can find more technical data about the material, chemical resistance, temperatures ► **chapter Design, page 1.38**

### Opening-principle



Series 117, 157, 167 snap-open along inner radius - Series 118, 158, 168 snap-open along outer radius

### Dimensioning

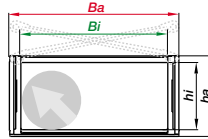

### Bending radius

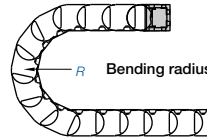

### Part No. structure

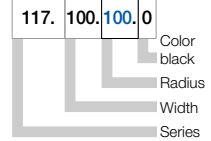

### Selection table

Series	Inner height <i>hi</i> [mm]	Inner width <i>Bi</i> [mm]	Outer width <i>Ba</i> [mm]	Outer height <i>ha</i> [mm]	Bending radius <i>R</i> [mm]	Unsupported length max. [m]	Page
R117/118	21	20-100	32-112	28	63 - 180	1,20	6.6
R157/158	40	40-200	56-216	50	100 - 250	2,25	6.12
R167/168	50	50-250	68-268	64	100 - 300	2,50	6.20

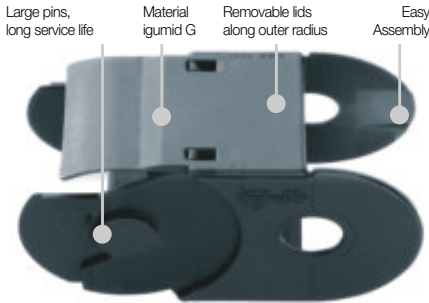

## E2 Series R - small pitch for smooth motion

- Protection for cables and hoses against chips (also hot chips)
- Small pitch for low noise, smooth operation
- Smooth, chip repellent exterior
- Lids removable for assembly time reduction
- Double stop dog for strong unsupported lengths
- KMA mounting brackets with attachment capability on all sides
- Very small radii possible due to small pitch
- You can find more technical data about the material, chemical resistance, temperatures ► **chapter Design, page 1.38**

### Opening-principle



Series R48, R58, R68 can be opened from one side

### Dimensioning

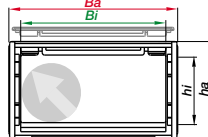

### Bending radius

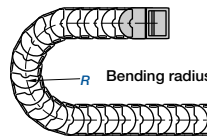

### Part No. structure

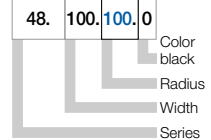

### Selection table

Series	Inner height <i>hi</i> [mm]	Inner width <i>Bi</i> [mm]	Outer width <i>Ba</i> [mm]	Outer height <i>ha</i> [mm]	Bending radius <i>R</i> [mm]	Unsupported length max. [m]	Page
R48	25	25-130	36-141	36	60 - 250	1,50	6.26
R58	35	50-200	66-216	50	75 - 250	2,30	6.34
R68	45	50-250	68-268	64	100 - 300	2,50	6.42

Comparison of the main characteristics

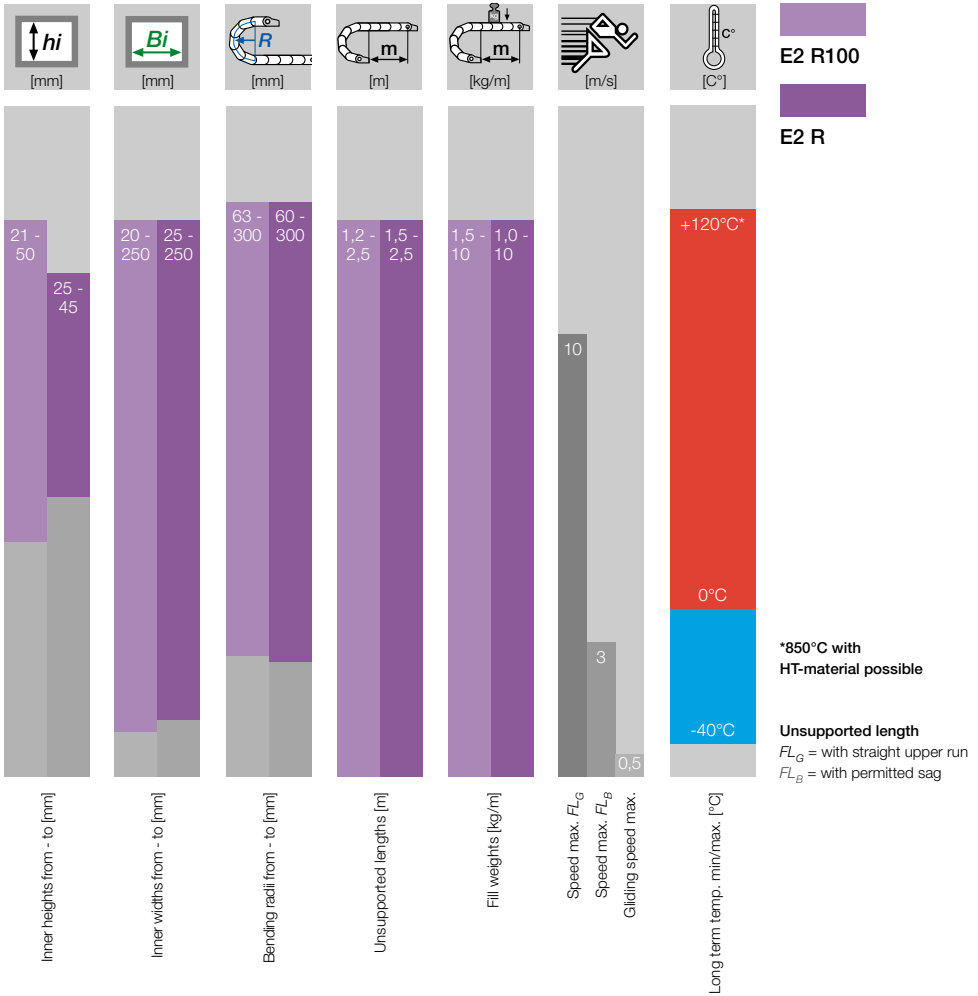

Additional quality features - System E2-E-Tubes

UL94-V2 classifications upon request

ESD Classification: Electrically conductive ESD/ATEX version upon request

iF-Design Awards - Series R117/118 and Series R68

E-Tubes with igumid HT material - repel hot chips, up to 850 °C

► Next page: Find application examples and assembly instructions

Since igus® introduced the first openable (2-piece) E-Tubes in the mid-1980's, many additions and improvements argued the program. igus® E-Tubes work in **hot chip areas**, in areas of dirt and dust generated by **woodworking, steelmills, pulp and paper, textile, agriculture, coal plant** and many other hostile environment. Use The **cost-effective alternative Series R100** as the first choice for application with low and medium speeds, **Series R** for **higher speeds**. We recommend this design for all new applications.

**Typical industries & applications**

- General machinery ● Material Handling ● Construction machinery
- Long travel applications in many industries ● Semicon ● ESD ATEX versions certified ● Theatrical & Entertainment & Amusement parcs ● Vehicles ● And many more



Preventative maintenance on E2 E-Tubes: Transparent, scratch-resistant lids from a special plastic material - snap-open, removable



U-shaped supported E-Tube for high lateral acceleration

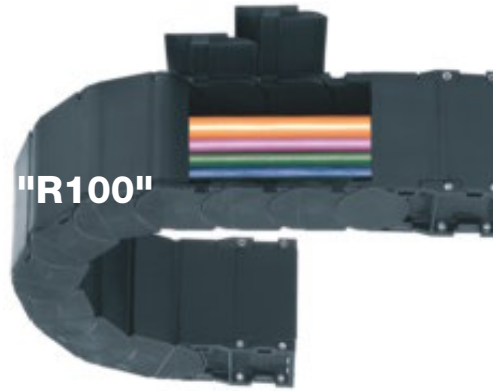

Series R100 - Cost effective alternative, for applications with low and medium speeds







Series R - For higher speeds and smooth running

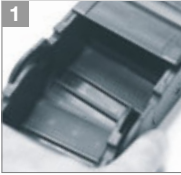

Standing application - R68 Tube - Note the first links are supported.

Type R100 | **Series R117/R118 · R157/R158 · R167/R168**

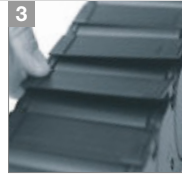
**Assembling | Type R100**





<b>1</b> 	<b>2</b> 	<b>3</b> 	<b>4</b> 
Push, click - and snap in pin	Swivel lids - push and snap	Slide last lid	Push and snap

**Separating | Type R100**

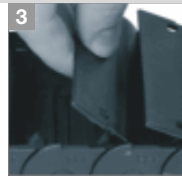

<b>5</b> 	<b>6</b> 	<b>7</b> 	<b>8</b> 
Lever open lid	Bend E-Tube to remove lid	Release side-link	Twist and pull apart

Type R | **Series R48 · R58 · R68**

**Assembling | Type R**

<b>1</b> 	<b>2</b> 	<b>3</b> 	<b>4</b> 
Push and click	Snap in pin	Slide lid	Push and snap

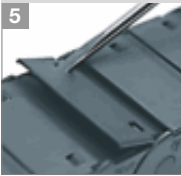
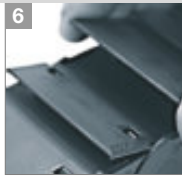
**Separating | Type R**

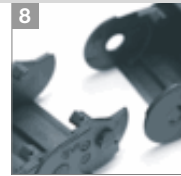
<b>5</b> 	<b>6</b> 	<b>7</b> 	<b>8</b> 
Lever open lid	Remove lid	Release side-link	Twist and pull apart





Price index



UL94-V2 classifications upon request



ESD classification: Electrically conductive ESD/ATEX version upon request



iF-Design Award Winner Series R117/R118

- ① Effective chip protection, even against hot metal chips
- ② Smooth, chip-repellent exterior
- ③ Double stop dog for strong unsupported length
- ④ Snap-open from the side, covered pin/bore connection
- ⑤ Lateral glide surfaces for side-mounted operation
- ⑥ Snap-open lids along inner or outer radius
- ⑦ Universal KMA mounting brackets with attachment capability on all sides
- ⑧ Space-efficient with optimized ratio of inner dimension to outer dimension

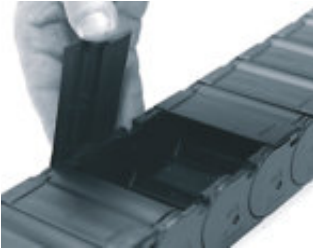

To open the E-Tube Series R100 lift up the lid and swivel lid to the side

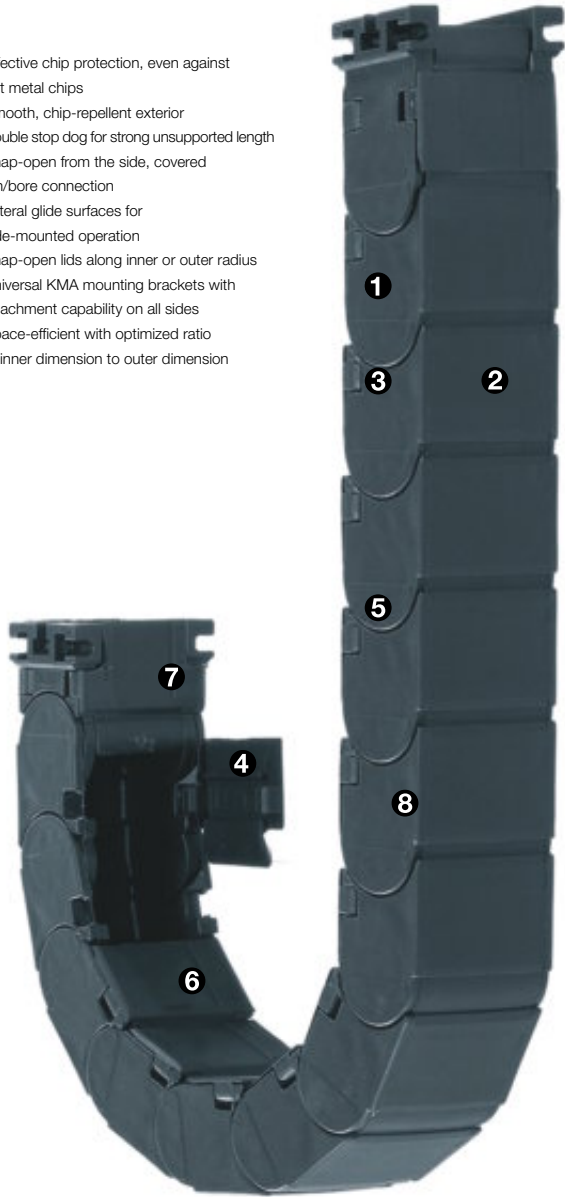

**When to use the Series R117/R118:**

- If snap-open accessibility along inner or outer radius is required
- If price is an issue
- If flush attachment is required



**When not to use it:**

- For smoother running and smaller pitch
  - ▶ E-Tubes E2, Series R48, page 6.26



**Order example complete E-Tube**

Please indicate E-Tube-lengths or number of links **Example: 1 m or 33 links**

1 m 117.100.100.0



E-Tube

with 2 separators 1186.01 assembled every 2<sup>nd</sup> link



Interior separation

1 set 11800.100.14



Mounting bracket

**Unsupported length**

$FL_G$  = with straight upper run

$FL_B$  = with permitted sag

Further information ► Design, page 1.12

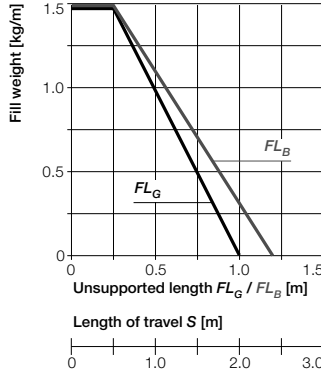
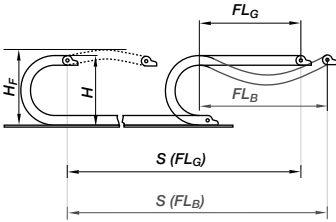

- $S$  = Length of travel
- $R$  = Bending radius
- $H$  = Nominal clearance height
- $H_F$  = Required clearance height
- $D$  = Overlength E-Chain\*  
radius in final position
- $K = \pi \cdot R + \text{"safety"}$

21

E2 E-Tubes Type R  
Inner height: 21 mm

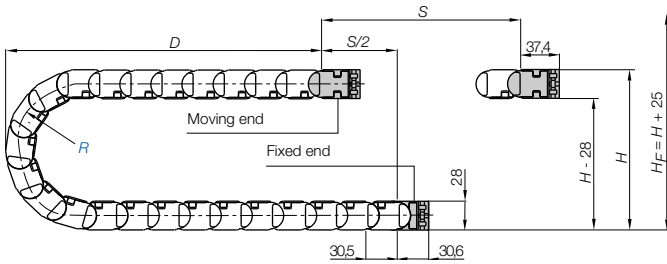

**Short travels - unsupported**

Unsupported E-Chains\* feature positive camber over short travels. This must be accounted for when specifying the clearance height  $H_F$ . Please consult igus\* if space is particularly restricted.

Pitch = 30,5 mm/link Links/m = 33 (1000,6 mm) Chain length =  $S/2 + K$

R	063	075	100	110	125	145	180
H	154	178	228	248	278	318	388
D	110	120	145	155	170	190	225
K	260	300	375	410	455	520	630

The required clearance height:  
 $H_F = H + 25$  mm  
(with 1,0 kg/m fill weight)

Phone +49- (0) 22 03-96 49-800  
Fax +49- (0) 22 03-96 49-222



**Hot Chips up to 850°C**

E-Tubes that repel hot chips, up to 850 °C

Some applications, depending on amount and size of the chips, can burn or melt the surface. That is no longer the case with the new igus® "igumid HT" material.

Further Information: [www.igus.de/en/HT](http://www.igus.de/en/HT)

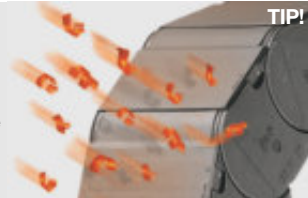

Speed / acceleration $FL_G$	max. 10 [m/s] / max. 100 [m/s <sup>2</sup> ]
Speed / acceleration $FL_B$	max. 3 [m/s] / max. 6 [m/s <sup>2</sup> ]
Gliding speed / acceleration (maximum)	max. 0,5 [m/s] / max. 5 [m/s <sup>2</sup> ]
Material - permitted temperature °C	igumid G / -40° up to +130° C
Flammability class, igumid G	VDE 0304 IIC UL94 HB

**Technical Data**



Details of material properties  
► page 1.38



► page 6.5



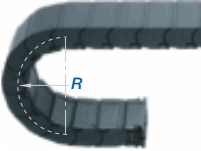
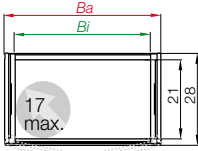

Part No. structure

117. 100. 100. 0



Series R117 - hinged, snap-open on both sides of the inner radius

Part No.	Bi [mm]	Ba [mm]	R [mm]	Bending radii						Weight [kg/m]
117.020.□.0	20	32	063	075	100	110	125	145	180	~ 0,43
117.025.□.0	25	37	063	075	100	110	125	145	180	~ 0,46
117.038.□.0	38	50	063	075	100	110	125	145	180	~ 0,56
117.048.□.0	48	60	063	075	100	110	125	145	180	~ 0,66
117.063.□.0	63	75	063	075	100	110	125	145	180	~ 0,76
117.080.□.0	80	92	063	075	100	110	125	145	180	~ 0,89
117.100.□.0	100	112	063	075	100	110	125	145	180	~ 1,06

Supplement Part No. with required radius. Example: 117.100.100.0

0 = standard color, other colors ▶ page 1.39 - Pitch = 30,5 mm/link - Links/m = 33

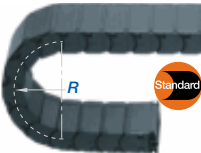
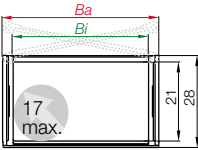

Part No. structure

118. 100. 100. 0



Series R118 - hinged, snap-open on both sides of the outer radius

Part No.	Bi [mm]	Ba [mm]	R [mm]	Bending radii						Weight [kg/m]
118.025.□.0	25	37	063	075	100	110	125	145	180	~ 0,46
118.048.□.0	48	60	063	075	100	110	125	145	180	~ 0,66
118.080.□.0	80	92	063	075	100	110	125	145	180	~ 0,89

The sizes 020 / 038 / 063 / 100 are available upon request.

Delivery time: approx. 8-10 weeks after receipt of order

Supplement Part No. with required radius. Example: 118.100.100.0

0 = standard color, other colors ▶ page 1.39 - Pitch = 30,5 mm/link - Links/m = 33



Series R117·R118 | Accessories | Interior Separation

Vertical Separator	
unassembled	1185.01
assembled	1186.01

Option 1: Vertical Separators

Vertical Separators are used if a vertical subdivision of the E-Chain® interior is required -

By standard Vertical Separators are assembled every other E-Chain® link

● Standard subdivision with Vertical Separator 1185.01

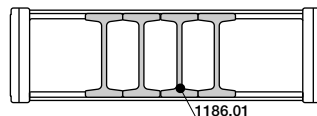

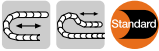

**Option KMA\* - pivoting**

- Pivoting
- Short and long travels
- Space-restricted
- Corrosion-resistant
- Pivoting option at fixed end available upon request (Part No. 11800...12)

\*KMA = Polymer Metal Mounting Bracket

Moving end (outer link)  
11800...1

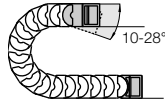

11800...4

Fixed end (inner link)



Mounting bracket attachment

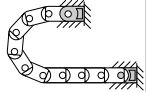

11800...4  
Fixed end

11800...1  
Moving end

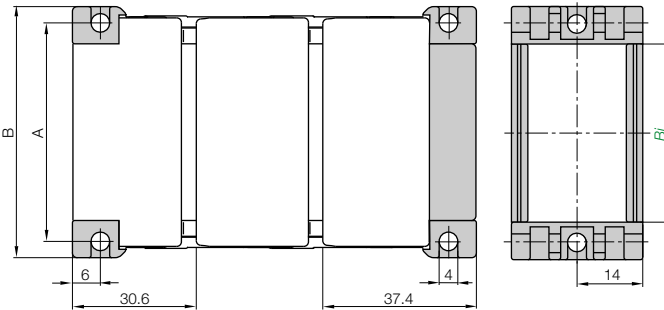

**Dimensions and order configurations**



The mounting brackets are supplied with hexagon nuts and can be attached with M4 bolts, or the mounting brackets may also be attached with M4 socket head cap bolts.

**Part No. structure**

11800.020.14.A



Full set, for both ends:

11800.020.14

Single-part order:

11800.020.1

Mounting bracket with bore

11800.020.4

Mounting bracket with pin

For Series	Part No. full set	Dim. A [mm]	Dim. B [mm]
117-118.020. ▶	11800.020.14	29	36
117-118.025. ▶	11800.025.14	34	41
117-118.038. ▶	11800.038.14	47	54
117-118.048. ▶	11800.048.14	57	64
117-118.063. ▶	11800.063.14	72	79
117-118.080. ▶	11800.080.14	89	96
117-118.100. ▶	11800.100.14	109	116

Please add the Part No. with the requested index - e.g. 11800.048.14

For the preassembled mode please add the index [A] e.g. 11800.048.14[A]

Phone +49- (0) 22 03-96 49-800  
Fax +49- (0) 22 03-96 49-222



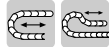

### Angled polymer bracket

- Locked connection to E-Tube
- Minimized external width
- For long travels
- Attachment option for strain relief tiwrap plate

Moving end (outer link)  
1180...1PZ(B)

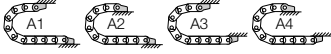
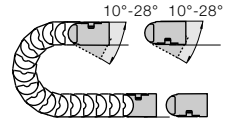

Possible installation conditions for assembled mounting brackets ► Order example "preassembled" below

1180...4PZ(B) Fixed end  
(inner link)

### Dimensions and order configurations

Strain relief is possible on the moving end and/or the fixed end.

1180...1PZ(B)  
Moving end

1180 ...4PZ(B)  
Fixed end

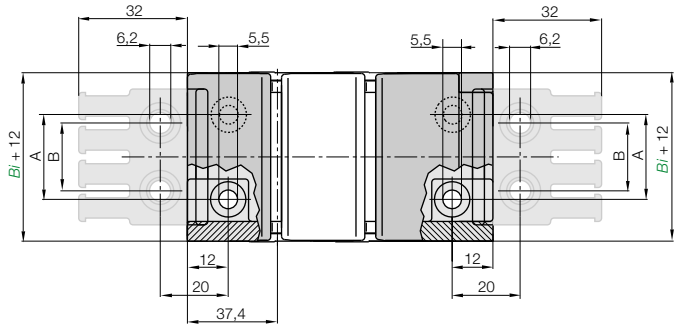

Phone +49- (0) 22 03-96 49-800  
Fax +49- (0) 22 03-96 49-222

igus® GmbH  
51147 Cologne

#### Part No. structure

1180.048.14.PZB.A1

A<sub>1</sub>... must be indicated on preassembled configurations with assembled tiwrap plates

Full set = 14

Width

Mounting brackets for selected chain type

Full set, for both ends:

1180.048.14.PZB + tiwrap plate

Single-part order:

1180.048.1.PZB + tiwrap plate

Mounting bracket with bore

1180.048.4.PZB + tiwrap plate

Mounting bracket with pin

For Series	Part No. full set with tiwrap plate	Part No. full set without tiwrap plate	Dim. A [mm]	Dim. B [mm]
117-118.025.	1180.025.14PZB	1180.025.14PZ	12	15
117-118.038.	1180.038.14PZB	1180.038.14PZ	25	20
117-118.048.	1180.048.14PZB	1180.048.14PZ	35	30
117-118.063.	1180.063.14PZB	1180.063.14PZ	50	40
117-118.080.	1180.080.14PZB	1180.080.14PZ	67	60
117-118.100.	1180.100.14PZB	1180.100.14PZ	87	80

Please add the Part No. with the requested index - e.g. 1180.048.12.PZB

For the preassembled mode please add the index A<sub>1</sub>...A<sub>4</sub> e.g. 1180.048.12PZB A<sub>1</sub>

The following parts are required for attachment of the mounting brackets:

- Countersunk bolt M5 DIN 912-8.8 Length depends on the thickness of the attachment base
- Hexagon nut M5 DIN 934-8

Internet: www.igus.de  
E-mail: info@igus.de

Tiewrap plate	No. of teeth <i>n</i>	Dim. C [mm]	Dim. B [mm]
2020.ZB	3	30	15
2030.ZB	4	40	20
2040.ZB	5	50	30
2050.ZB	6	60	40
2070.ZB	8	80	60
2090.ZB = (2030.ZB + 2040.ZB)	9	90	-
2100.ZB	10	100	80
2125.ZB = (2050.ZB + 2050.ZB)	12	120	-

### Tiewrap plate as individual part

As individual component screwed on KMA. Can be plugged in the mounting brackets. **Details ▶ chapter 10**

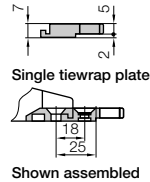
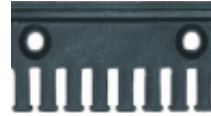
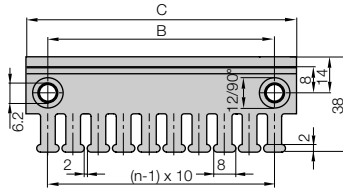

E2 E-Tubes Type R  
Inner height: 21 mm

### Cable tiewraps as individual part

Cable tiewraps (100-piece bag)	Width x length	max. Ø	Tensile strength
CFB.001	4,8 x 150 mm	36 mm	222 N



Other strain relief elements  
▶ chapter 10

Phone +49- (0) 22 03-96 49-800  
Fax +49- (0) 22 03-96 49-222



▶ chapter 10

## PUR-Servo-cable especially for machine tools - Chainflex® CF260

TIP!

PUR outer jacket, shielded, oil-resistand, PVC- and halogen-free  
Further Information: [www.igus.de/en/CF260](http://www.igus.de/en/CF260)

CHAINFLEX® CF260



▶ page 6.5



UL94-V2 classifications upon request



ESD classification:  
Electrically conductive  
ESD/ATEX version upon request

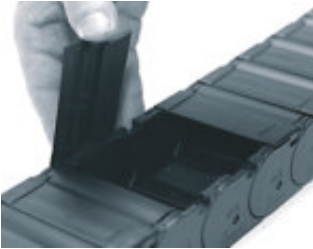

To open the E-Tube Series R100 lift up the lid and swivel lid to the side

- ❶ Snap-open lids along inner or outer radius
- ❷ Snap-open from the side, covered pin/bore connection
- ❸ Effective chip protection, even against hot metal chips
- ❹ Double stop dog for strong unsupported length
- ❺ Lateral glide surfaces for side-mounted operation
- ❻ Universal KMA mounting brackets with attachment capability on all sides
- ❼ Space-efficient with optimized ratio of inner dimension to outer dimension
- ❽ **Strain relief separator** - Separator with integrated strain relief for the use in the first or last chain link ► [page 6.18](#)



**When to use the Series R157/R158:**

- If snap-open accessibility along inner or outer radius is required
- If a low-cost, lightweight E-Tube for many types of applications required
- If flush attachment is required
- If chip-repellent features are required



**When not to use it:**

- If snap-open accessibility along both sides is required  
► [System E4/00, Series R770, page 7.26](#)
- If very smooth travel due to small pitch is required  
► [Type R, Series R58, page 6.34](#)



**Order example complete E-Tube**

Please indicate E-Tube-lengths or number of links **Example: 1 m or 22 links**

1 m **157.088.100.0**

E-Tube

with 2 separators **1586.01** assembled every 2<sup>nd</sup> link

Interior separation

1 set **15800.088.12**

Mounting bracket

**Unsupported length**

$FL_G$  = with straight upper run

$FL_B$  = with permitted sag

Further information ► Design, page 1.12

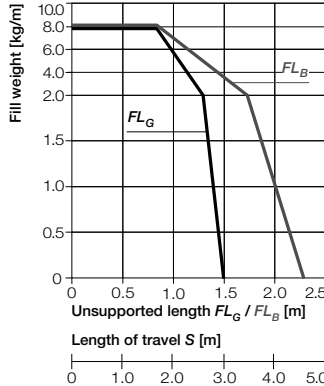
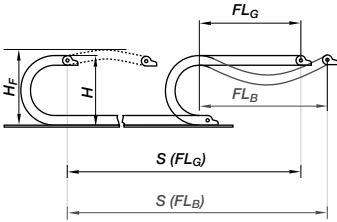

- S = Length of travel
- R = Bending radius
- H = Nominal clearance height
- $H_F$  = Required clearance height
- D = Overlength E-Chain® radius in final position
- $K = \pi \cdot R + \text{"safety"}$

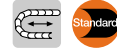
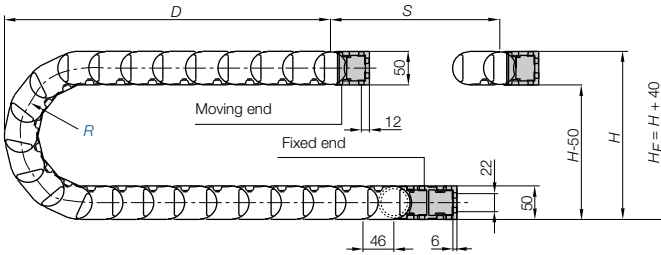

**Short travels - unsupported**

Unsupported E-Chains® feature positive camber over short travels. This must be accounted for when specifying the clearance height  $H_F$ . Please consult igus® if space is particularly restricted.

Pitch = 46 mm/link    Links/m = 22 (1012 mm)    Chain length =  $S/2 + K$

R	100	125	150	175	200	250
H	250	300	350	400	450	550
D	175	200	225	250	275	325
K	410	485	565	645	725	880

The required clearance height:  
 $H_F = H + 40$  mm  
(with 1,0 kg/m fill weight)

**Hot Chips up to 850°C**

E-Tubes that repel hot chips, up to 850 °C

Some applications, depending on amount and size of the chips, can burn or melt the surface. That is no longer the case with the new igus® "igumid HT" material.

Further Information: [www.igus.de/en/HT](http://www.igus.de/en/HT)

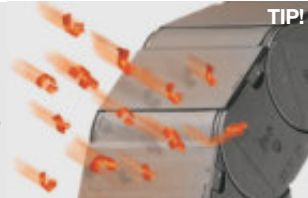

Speed / acceleration $FL_G$	max. 10 [m/s] / max. 100 [m/s²]
Speed / acceleration $FL_B$	max. 3 [m/s] / max. 6 [m/s²]
Gliding speed / acceleration (maximum)	max. 0,5 [m/s] / max. 5 [m/s²]
Material - permitted temperature °C	igumid G / -40° up to +130° C
Flammability class, igumid G	VDE 0304 IIC UL94 HB

**Technical Data**



Details of material properties  
► page 1.38



igus® E-ChainSystems®

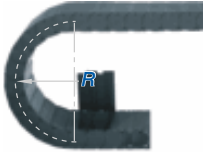
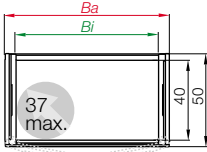

Series R157 - hinged, snap-open on both sides of the inner radius

Part No.	Bi (mm)	Ba (mm)	R (mm)	Bending radii	Weight [kg/m]
157.040.□.0*	40	56	100	125 150 175 200 250	~ 1,21
157.050.□.0	50	66	100	125 150 175 200 250	~ 1,30
157.075.□.0	75	91	100	125 150 175 200 250	~ 1,50
157.088.□.0	88	104	100	125 150 175 200 250	~ 1,57
157.090.□.0**	88	104	100	125 150 175 200 250	~ 1,63
157.100.□.0	100	116	100	125 150 175 200 250	~ 1,71
157.125.□.0	125	141	100	125 150 175 200 250	~ 1,92
157.135.□.0	135	150	100	125 150 175 200 250	~ 2,10
157.150.□.0	150	166	100	125 150 175 200 250	~ 2,13
157.175.□.0	175	191	100	125 150 175 200 250	~ 2,34
157.200.□.0	200	216	100	125 150 175 200 250	~ 2,55

\* Lid removable only, not hinged

\*\* Same dimensions as 157.088 - less recent design, no hinged option

Supplement Part No. with required radius. Example: 157.100.100.0

0 = standard color, other colors ▶ page 1.39 · Pitch = 46 mm/link · Links/m = 22

Part No. structure

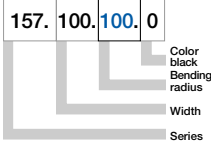

Phone +49- (0) 22 03-96 49-800  
Fax +49- (0) 22 03-96 49-222

igus® GmbH  
51147 Cologne

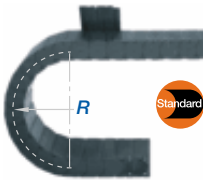
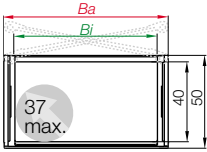

Series R158 - hinged, snap-open on both sides of the outer radius

Part No.	Bi (mm)	Ba (mm)	R (mm)	Bending radii	Weight [kg/m]
158.040.□.0*	40	56	100	125 150 175 200 250	~ 1,21
158.050.□.0	50	66	100	125 150 175 200 250	~ 1,30
158.075.□.0	75	91	100	125 150 175 200 250	~ 1,50
158.088.□.0	88	104	100	125 150 175 200 250	~ 1,57
158.090.□.0**	88	104	100	125 150 175 200 250	~ 1,63
158.100.□.0	100	116	100	125 150 175 200 250	~ 1,71
158.125.□.0	125	141	100	125 150 175 200 250	~ 1,92
158.135.□.0	135	150	100	125 150 175 200 250	~ 2,10
158.150.□.0	150	166	100	125 150 175 200 250	~ 2,13
158.175.□.0	175	191	100	125 150 175 200 250	~ 2,34
158.200.□.0	200	216	100	125 150 175 200 250	~ 2,55

\* Lid removable only, not hinged

\*\* Same dimensions as 158.088 - less recent design, no hinged option

The size 125 is available upon request. Delivery time: approx. 8-10 weeks after receipt of order

Supplement Part No. with required radius. Example: 158.100.100.0

0 = standard color, other colors ▶ page 1.39 · Pitch = 46 mm/link · Links/m = 22

Part No. structure

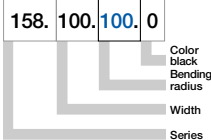

Internet: www.igus.de  
E-mail: info@igus.de



### Option 1: Vertical Separators

Vertical Separators are used if a vertical subdivision of the E-Chain® interior is required -

By standard Vertical Separators are assembled every other E-Chain® link

- Standard subdivision with Vertical Separator 1586.01
- Asymmetrical Separator 1586.01.A for side-mounted operations
- Strain Relief Separator 1586.01.Z, integrable in the mounting bracket, to position at any point - can be combined with Full-Width Shelf 221.X and Shelf 2210.X

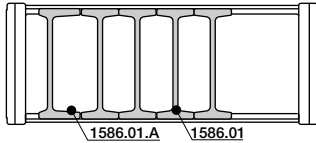

Vertical Separator	
unassembled	1585.01
assembled	1586.01



Asymmetrical Separator	
unassembled	1585.01.A
assembled	1586.01.A



Strain Relief Separator	
unassembled	1585.01.Z
assembled	1586.01.Z



E2 E-Tubes Type R  
Inner height: 40 mm

### Option 2: Full-Width Shelves

For applications involving many thin cables with similar or identical diameters

- Vertical Separator, slotted 1586.02 for applications with Full-Width Shelf 221.X

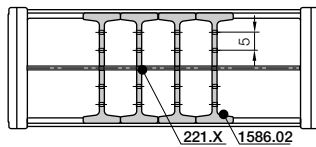

Vert. Separator, slotted	
unassembled	1585.02
assembled	1586.02



Width X [mm]	Part No. unassembled	Part No. assembled
40	220.40	221.40
50	220.50	221.50
75	220.75	221.75
88	220.88	221.88
90	220.90	221.90
100	220.100	221.100

Width X [mm]	Part No. unassembled	Part No. assembled
125	220.125	221.125
135	220.135	221.135
150	220.150	221.150
175	220.175	221.175
200	220.200	221.200

Full-Width Shelf	
Width	X-1
Thickness	t = 2,5

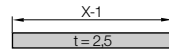

Phone +49- (0) 22 03-96 49-800  
Fax +49- (0) 22 03-96 49-222

### Option 3: Shelves

For applications involving many cables with similar or identical diameters. Partial separation into individual chambers can be achieved and the entire width Bi-10 mm can be used

- Shelf 2210.X can be combined with Middle Plate 1586.03

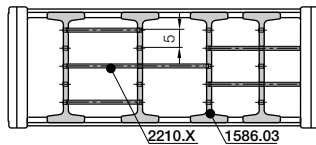

Middle Plate	
unassembled	1585.03
assembled	1586.03



Width X [mm]	Part No. unassembled	Part No. assembled
18	2200.18	2210.18
23	2200.23	2210.23
28	2200.28	2210.28
33	2200.33	2210.33
38	2200.38	2210.38
43	2200.43	2210.43
48	2200.48	2210.48

Width X [mm]	Part No. unassembled	Part No. assembled
58	2200.58	2210.58
68	2200.68	2210.68
73	2200.73	2210.73
88	2200.88	2210.88
99	2200.99	2210.99
124	2200.124	2210.124
149	2200.149	2210.149

Shelf	
Width	X
Offset	X - 7
Thickness	t = 2,5

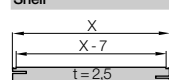

▶ page 6.5



**Option KMA\* - pivoting, extended**

- Recommended for unsupported and gliding applications
- Extended, pivoting
- Easy to install
- Universal mountable with attachment capability on all sides
- Locked connection to E-Tube
- Long travels with lowered mounting height possible

\*KMA = Polymer Metal Mounting Bracket

Moving end (outer link)  
15800/15801...1

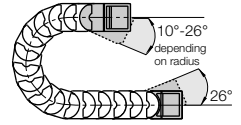

15800/15801...2  
Fixed end (inner link)

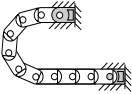
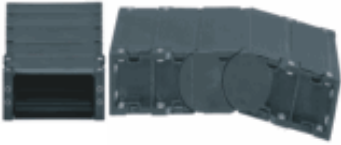

The attachment variants arising automatically by the choice of the KMA mounting bracket

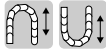

**Option KMA - locking, extended**

- Recommended for vertical hanging / standing applications
- Extended, locking
- Easy to install
- Flush mounting at both ends of the E-Tube
- Universal mountable with attachment capability on all sides
- Corrosion-resistant

Moving end (outer link)  
15800/15801...3

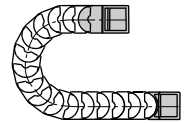

15800/15801...4  
Fixed end (inner link)

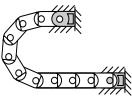

The attachment variants arising automatically by the choice of the KMA mounting bracket

**Dimensions and order configurations**



Quickflange upon request

**Part No. structure (pivoting)**

15800.100.12.A



A... must be indicated on preassembled configurations  
Full set pivoting = 12  
Width  
KMA for selected chain type

Full set, for both ends:

15800.100.12

Single-part order:

15800.100.1

Mounting bracket with bore

15800.100.2

Mounting bracket with pin

**Part No. structure (locking)**

15800.100.34.A

A... must be indicated on preassembled configurations  
Full set locking = 34  
Width  
KMA for selected chain type

Full set, for both ends:

15800.100.34

Single-part order:

15800.100.3

Mounting bracket with bore

15800.100.4

Mounting bracket with pin

15800/15801...1 Standard! (pivoting)      Standard! (pivoting) 15800/15801...2      Quickflange available  
15800/15801...3 (locking)      (locking) 15800/15801...4      upon request  
Moving end      Fixed end

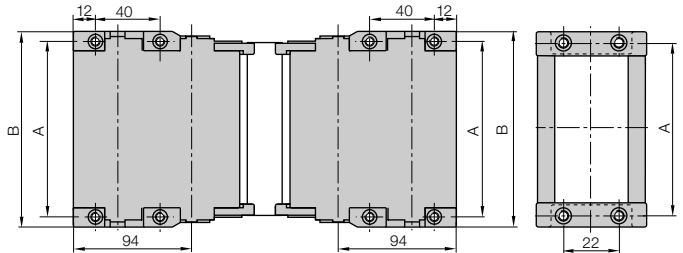

For Series	Part No. full set	Dim. A [mm]	Dim. B [mm]
157-158.040	15801.040	50	61
157-158.050	15800.050	60	71
157-158.075	15800.075	85	96
157-158.088	15800.088	98	109
157-158.090	15801.090	98	109
157-158.100	15800.100	110	121
157-158.125	15800.125	135	146
157-158.135	15800.135	145	156
157-158.150	15800.150	160	171
157-158.175	15800.175	185	196
157-158.200	15800.200	210	221

Please add the Part No. with the requested index - 12 for the pivoting configuration

e.g. 15800.100.12 or 34 for the locking configuration e.g. 15800.100.34

For the preassembled mode please add the index [A] e.g. 15800.100.12 [A]

The following parts are required for attachment of the mounting brackets:

- Socket head cap bolt M5 DIN 912-B.8 Length depends on the thickness of the attachment base
- Washer 5,3 DIN 125-ST ● Hexagon nut M5 DIN 934-8



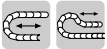

**Option KMA\* - pivoting, abbreviated**

- Recommended for unsupported and gliding applications
- Abbreviated, pivoting
- Universal mountable with attachment capability on all sides
- Locked connection to E-Tube
- Corrosion-resistant
- Space-restricted
- Long travels with lowered mounting height possible

\*KMA = Polymer Metal Mounting Bracket

Moving end (outer link)  
1580...1

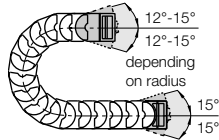

Fixed end (inner link)  
1580...2



The attachment variants arising automatically by the choice of the KMA mounting bracket

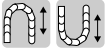
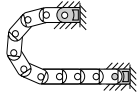

**Option KMA - locking, abbreviated**

- Recommended for vertical hanging / standing applications
- Abbreviated, locking
- Flush mounting at both ends of the E-Tube
- Corrosion-resistant
- Flush mounting, turned 90° at fixed end option

Moving end (outer link)  
1585...1

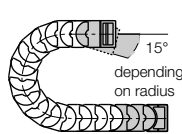

Fixed end (inner link)  
1585...2

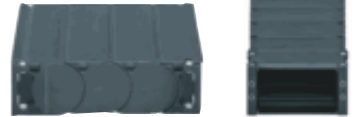

The attachment variants arising automatically by the choice of the KMA mounting bracket

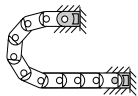

1580...1 (pivoting)

1585...1 (locking)

Moving end

(pivoting) 1580...2

(locking) 1585...2

Fixed end

Quickflange available upon request

**Dimensions and order configurations**



**Part No. structure (pivoting)**

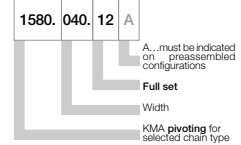

Full set, for both ends:

1580,040,12

Single-part order:

1580,040,1

Mounting bracket with bore

1580,040,2

Mounting bracket with pin

**Part No. structure (locking)**

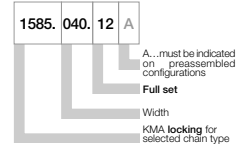

Full set, for both ends:

1585,040,12

Single-part order:

1585,040,1

Mounting bracket with bore

1585,040,2

Mounting bracket with pin

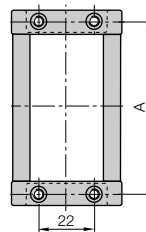
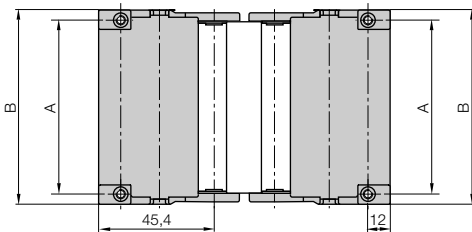

For Series	Part No. full set	Dim. A [mm]	Dim. B [mm]
157-158.040	.040.12	50	61
157-158.050	.050.12	60	71
157-158.075	.075.12	85	96
157-158.088	.088.12	98	109
157-158.090	.090.12	98	109
157-158.100	.100.12	110	121
157-158.125	.125.12	135	146
157-158.135	.135.12	145	156
157-158.150	.150.12	160	171
157-158.175	.175.12	185	196
157-158.200	.200.12	210	221

Please add the Part No. with the requested index - 1580 for the pivoting configuration

e.g. 1580,100,12 or 1585 for the locking configuration e.g. 1585,100,12

For the preassembled mode please add the index A e.g. 1580,100,12 A

The following parts are required for attachment of the mounting brackets:

- Socket head cap bolt M5 DIN 912-8.8 Length depends on the thickness of the attachment base
- Washer 5,3 DIN 125-ST ● Hexagon nut M5 DIN 934-8



Strain relief separator for the use in the first or last chain link ▶ page 6.18

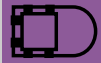

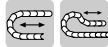

**Flange mounting brackets made of steel**

- Metallic flange brackets with popular hole patterns, easily be replaced by their modern successors, without having to alter the hole pattern
- Bolted connection outside of chain cross-section possible
- Universal mountable with attachment capability on all sides
- Steel, galvanized
- One-piece mounting bracket
- High stability

Moving end (outer link)  
906.461.X (X = B)

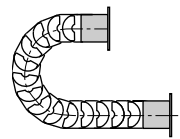

906.461.X (X = B)

Fixed end (inner link)

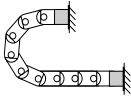

Flush mounting possibilities at both ends of the E-Tube

**Dimensions and order configurations**

Hole patterns flange steel mounting brackets 906.461.X (X = B)

906.461.X (X = B)  
Moving end

906.461.X (X = B)  
Fixed end

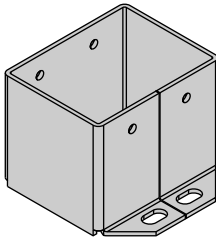

Principle sketch flange steel mounting brackets

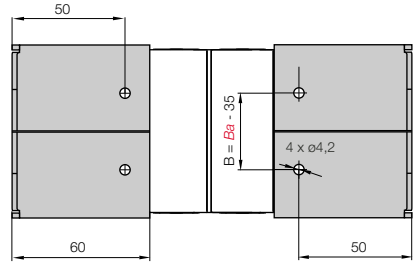
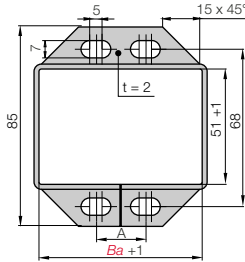

For Series	Hole pattern	Part No. full set	Bi [mm]	Ba [mm]	Dim. A [mm]	Dim. B [mm]
157-158.050 ▶	58.05	906.461.1	50	66	20	31
157-158.075 ▶	58.1	906.461.2	75	91	30	57

Phone +49- (0) 22 03-96 49-800  
Fax +49- (0) 22 03-96 49-222



Mounting only with hexagon socket DIN 912 M6 and washer DIN 125, 6,3 mm

igus® GmbH  
51147 Cologne

R100 | Series R157-R158 | Accessories | Strain Relief

**NEW Strain relief separator**

Separator with integrated strain relief, for use in the first or last chain link. For manufacturing of switchgear cabinets or for the assembly of machines. Easy to assemble without any fastening device. Separator base 1585.01.Z is 22 mm wide. The possible number of separators per E-Chain® is defined by its inner width  $B_i$  and by the cable-diameter. **Details ▶ chapter 10**

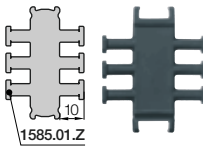

Part No.	Number of teeth	For Series
1585.01.Z	3 both sides	R157/158 E-Tube

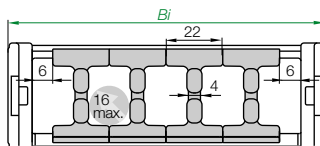

**Strain Relief Separator** - The number of separators is depending on the cables and the available inner space. Example: E-Chain® inner width  $B_i$  100 mm: 4 Strain Relief Separator, max. cable diameter 16 mm. **Details ▶ chapter 10**



Other strain relief elements  
▶ chapter 10

Internet: [www.igus.de](http://www.igus.de)  
E-mail: [info@igus.de](mailto:info@igus.de)



E2 E-Tubes side-mounted and unsupported in a chip area



igus® E-Tubes protect your cables and are easy to open

E2 E-Tubes Type R  
Inner height: 40 mm

Phone +49- (0) 22 03-96 49-800  
Fax +49- (0) 22 03-96 49-222



▶ chapter 10



▶ page 6.5



UL94-V2 classifications upon request



ESD classification:  
Electrically conductive  
ESD/ATEX version upon request

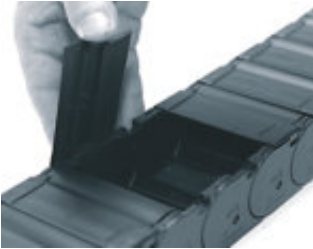

To open the E-Tube Series R100 lift up the lid and swivel lid to the side

- ❶ Double stop dog for strong unsupported length
- ❷ Effective chip protection, even against hot metal chips
- ❸ Covered pin/bore connection
- ❹ Lateral glide surfaces for side-mounted operation
- ❺ Snap-open lids along inner or outer radius
- ❻ Lids can be swivelled from the left to the right
- ❼ Space-efficient with optimized ratio of inner dimension to outer dimension
- ❽ Universal KMA mounting brackets with attachment capability on all sides
- ❾ **Strain relief separator** - Separator with integrated strain relief for the use in the first or last chain link ▶ page 6.25



**When to use the Series R167/R168:**

- If snap-open accessibility along inner or outer radius is required
- If a low-cost, lightweight E-Tube for many types of applications required
- If flush attachment is required
- If chip-repellent features are required



**When not to use it:**

- If snap-open accessibility along both sides is required  
▶ **System E4/00, Series R780, page 7.36**
- If very smooth travel due to small pitch is required  
▶ **Type R, Series R68, page 6.42**



**Order example complete E-Tube**

Please indicate E-Tube-lengths or number of links **Example: 1 m or 17 links**

1 m **167.100.100.0**

E-Tube

with 2 separators **1686.01** assembled every 2<sup>nd</sup> link

Interior separation

1 set **1680.100.12**

Mounting bracket

**Unsupported length**

$FL_G$  = with straight upper run

$FL_B$  = with permitted sag

Further information ► Design, page 1.12

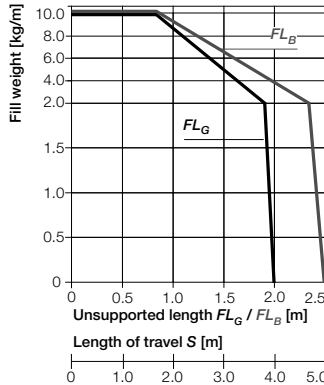
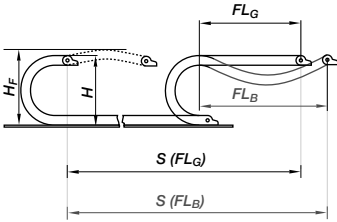

- $S$  = Length of travel
- $R$  = Bending radius
- $H$  = Nominal clearance height
- $H_F$  = Required clearance height
- $D$  = Overlength E-Chain® radius in final position
- $K = \pi \cdot R + \text{"safety"}$



E2 E-Tubes Type R  
Inner height: 50 mm

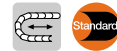
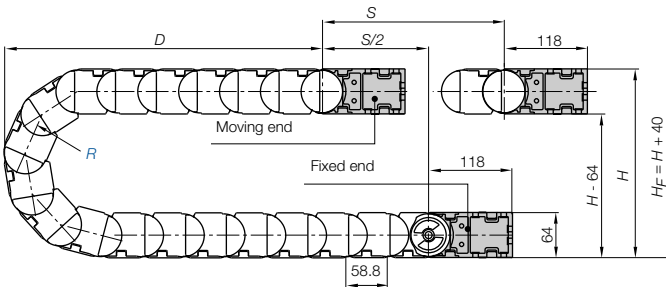

**Short travels - unsupported**

Unsupported E-Chains® feature positive camber over short travels. This must be accounted for when specifying the clearance height  $H_F$ . Please consult igus® if space is particularly restricted.

Pitch = 58,8 mm/link    Links/m = 17 (999,6 mm)    Chain length =  $S/2 + K$

R	100	125	150	175	200	225	250	300
H	264	314	364	414	464	514	564	664
D	180	205	230	255	280	305	330	380
K	440	510	590	670	750	830	910	1060

The required clearance height:  
 $H_F = H + 40$  mm  
(with 2,0 kg/m fill weight)



**Hot Chips up to 850°C**

E-Tubes that repel hot chips, up to 850 °C

Some applications, depending on amount and size of the chips, can burn or melt the surface. That is no longer the case with the new igus® "igumid HT" material.

Further Information: [www.igus.de/en/HT](http://www.igus.de/en/HT)



Speed / acceleration $FL_G$	max. 10 [m/s] / max. 100 [m/s²]
Speed / acceleration $FL_B$	max. 3 [m/s] / max. 6 [m/s²]
Gliding speed / acceleration (maximum)	max. 0,5 [m/s] / max. 5 [m/s²]
Material - permitted temperature °C	igumid G / -40° up to +130° C
Flammability class, igumid G	VDE 0304 IIC UL94 HB

**Technical Data**



Details of material properties  
► page 1.38



► page 6.5



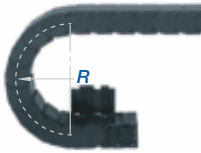
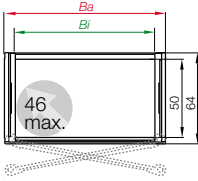

Part No. structure

167. 100. 100. 0



Series R167 - hinged, snap-open on both sides of the inner radius

Part No.	Bi (mm)	Ba (mm)	R (mm)	Bending radii								Weight [kg/m]
167.050.□.0	50	68	100	125	150	175	200	225	250	300	~ 1,58	
167.075.□.0	75	93	100	125	150	175	200	225	250	300	~ 1,84	
167.100.□.0	100	118	100	125	150	175	200	225	250	300	~ 2,09	
167.115.□.0	115	133	100	125	150	175	200	225	250	300	~ 2,24	
167.125.□.0	125	143	100	125	150	175	200	225	250	300	~ 2,35	
167.150.□.0	150	168	100	125	150	175	200	225	250	300	~ 2,60	
167.175.□.0	175	193	100	125	150	175	200	225	250	300	~ 2,86	
167.200.□.0	200	218	100	125	150	175	200	225	250	300	~ 3,11	
167.225.□.0	225	243	100	125	150	175	200	225	250	300	~ 3,37	
167.250.□.0	250	268	100	125	150	175	200	225	250	300	~ 3,62	

Supplement Part No. with required radius. Example: 167.100.100.0

0 = standard color, other colors ▶ page 1.39 - Pitch = 58,8 mm/link - Links/m = 17

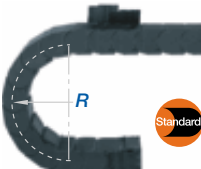
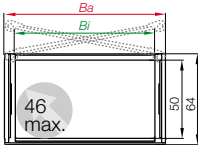

Part No. structure

168. 100. 100. 0



Series R168 - hinged, snap-open on both sides of the outer radius

Part No.	Bi (mm)	Ba (mm)	R (mm)	Bending radii								Weight [kg/m]
168.050.□.0	50	68	100	125	150	175	200	225	250	300	~ 1,58	
168.075.□.0	75	93	100	125	150	175	200	225	250	300	~ 1,84	
168.100.□.0	100	118	100	125	150	175	200	225	250	300	~ 2,09	
168.115.□.0	115	133	100	125	150	175	200	225	250	300	~ 2,24	
168.150.□.0	150	168	100	125	150	175	200	225	250	300	~ 2,60	
168.175.□.0	175	193	100	125	150	175	200	225	250	300	~ 2,86	
168.200.□.0	200	218	100	125	150	175	200	225	250	300	~ 3,11	

The sizes 125 / 225 / 250 are available upon request. Delivery time: approx. 8-10 weeks after receipt of order

Supplement Part No. with required radius. Example: 168.100.100.0

0 = standard color, other colors ▶ page 1.39 - Pitch = 58,8 mm/link - Links/m = 17



### Option 1: Vertical Separators

Vertical Separators are used if a vertical subdivision of the E-Chain® interior is required -

By standard Vertical Separators are assembled every other E-Chain® link

- **Standard** subdivision with Vertical Separator 1686.01
- **Strain Relief Separator** 1686.01.Z, integrable in the mounting bracket, to position at any point - can be combined with Full-Width Shelf 321.X and Shelf 2210.X

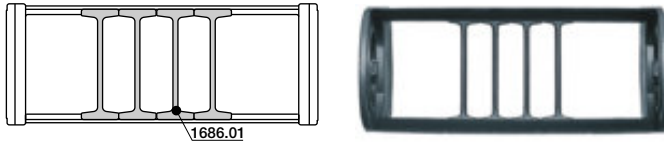

Vertical Separator	
unassembled	1685.01
assembled	1686.01

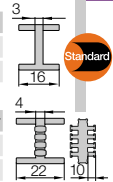

Strain Relief Separator	
unassembled	1685.01.Z
assembled	1686.01.Z

E2 E-Tubes Type R  
Inner height: 50 mm

### Option 2: Full-Width Shelves

For applications involving many thin cables with similar or identical diameters

- Vertical Separator, slotted 1686.02 for applications with Full-Width Shelf 321.X

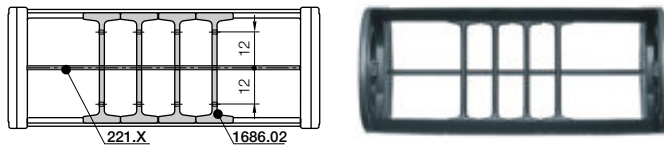

Vert. Separator, slotted	
unassembled	1685.02
assembled	1686.02



Width X [mm]	Part No. unassembled	Part No. assembled
40	320.40	321.40
50	320.50	321.50
75	320.75	321.75
88	320.88	321.88
90	320.90	321.90
100	320.100	321.100

Width X [mm]	Part No. unassembled	Part No. assembled
125	320.125	321.125
135	320.135	321.135
150	320.150	321.150
175	320.175	321.175
200	320.200	321.200

Full-Width Shelf	
X - 1	
t = 3,4	

### Option 3: Shelves

For applications involving many cables with similar or identical diameters. Partial separation into individual chambers can be achieved and the entire width B/-10 mm can be used

- Shelf 2210.X can be combined with Middle Plate 1686.03 and Side Plate 1686.04

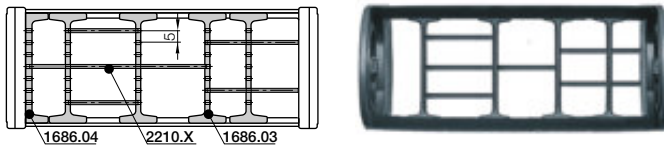

Middle Plate	
unassembled	1685.03
assembled	1686.03



Side Plate	
unassembled	1685.04
assembled	1686.04



Width X [mm]	Part No. unassembled	Part No. assembled
18	2200.18	2210.18
23	2200.23	2210.23
28	2200.28	2210.28
33	2200.33	2210.33
38	2200.38	2210.38
43	2200.43	2210.43
48	2200.48	2210.48

Width X [mm]	Part No. unassembled	Part No. assembled
58	2200.58	2210.58
68	2200.68	2210.68
73	2200.73	2210.73
88	2200.88	2210.88
99	2200.99	2210.99
124	2200.124	2210.124
149	2200.149	2210.149

Shelf	
X	
X - 7	
t = 2,5	



Phone +49- (0) 22 03-96 49-800  
Fax +49- (0) 22 03-96 49-222

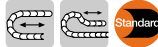

**Option KMA\* - pivoting**

- Recommended for unsupported and gliding applications
- Option - KMA with Quickflange, bolted connection outside of E-Tube cross-section
- Universal mountable with attachment capability on all sides
- Locked connection to E-Tube
- Long travels with lowered mounting height possible
- Corrosion-resistant

\*KMA = Polymer Metal Mounting Bracket

Moving end (outer link)  
1680...1

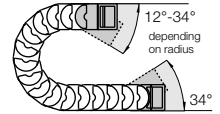

1680...2

Fixed end (inner link)

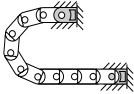

The attachment variants arising automatically by the choice of the KMA mounting bracket

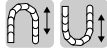

**Option KMA - locking**

- Recommended for vertical hanging / standing applications
- Option - KMA with Quickflange, bolted connection outside of E-Tube cross-section
- At very high speed and acceleration
- Universal mountable with attachment capability on all sides
- Flush mounting at both ends of the E-Tube

Moving end (outer link)  
1680...3

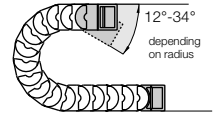

1680...4

Fixed end (inner link)

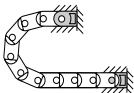

The attachment variants arising automatically by the choice of the KMA mounting bracket

**Dimensions and order configurations**



Quickflange upon request

**Part No. structure (pivoting)**

1680. 100. 12 A



- A... must be indicated on preassembled configurations
- Full set pivoting = 12
- Width
- KMA for selected chain type

Full set, for both ends:

1680.100.12

Single-part order:

1680.100.1

Mounting bracket with bore

1680.100.2

Mounting bracket with pin

**Part No. structure (locking)**

1680. 100. 34 A

- A... must be indicated on preassembled configurations
- Full set locking = 14
- Width
- KMA for selected chain type

Full set, for both ends:

1680.100.14

Single-part order:

1680.100.1

Mounting bracket with bore

1680.100.4

Mounting bracket with pin

**Quickflange**

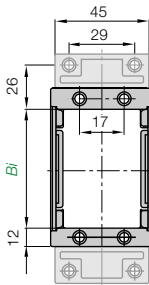

**1680...1 Standard! (pivoting)**

**1680...3 (locking)**

**Moving end**

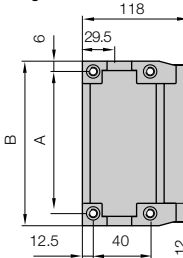

**Standard! (pivoting) 1680...2**

**(locking) 1680...4**

**Fixed end**

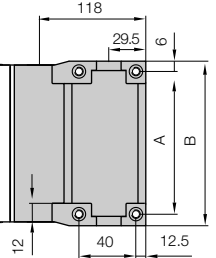

For Series	Part No. full set	Part No. full set with Quickflange	Dim. A [mm]	Dim. B [mm]
167-168.050	1680.050.□	1680.050.□ QF	62	74
167-168.075	1680.075.□	1680.075.□ QF	87	99
167-168.100	1680.100.□	1680.100.□ QF	112	124
167-168.115	1680.115.□	1680.115.□ QF	127	139
167-168.125	1680.125.□	1680.125.□ QF	137	149
167-168.150	1680.150.□	1680.150.□ QF	162	174
167-168.175	1680.175.□	1680.175.□ QF	187	199
167-168.200	1680.200.□	1680.200.□ QF	212	224
167-168.225	1680.225.□	1680.225.□ QF	237	249
167-168.250	1680.250.□	1680.250.□ QF	262	274

Please add the Part No. with the requested index - 12 for the pivoting configuration

e.g. 1680.100.12 or 14 for the locking configuration e.g. 1680.100.14

For the preassembled mode please add the index A e.g. 1680.100.12 A

Quickflange unassembled: Part No. 16800.QF

The following parts are required for attachment of the mounting brackets:

- Socket head cap bolt M5 DIN 912-B.8 Length depends on the thickness of the attachment base
- Washer 5,3 DIN 125-ST ● Hexagon nut M5 DIN 934-8



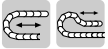

**Flange mounting brackets made of steel**

- Metallic flange brackets with popular hole patterns, easily be replaced by their modern successors, without having to alter the hole pattern
- Bolted connection outside of chain cross-section possible
- Universal mountable with attachment capability on all sides
- Steel, galvanized
- One-piece mounting bracket
- High stability

Moving end (outer link)  
905.050.X (X = Bi)

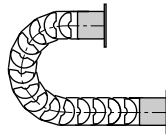

905.050.X (X = Bi)  
Fixed end (inner link)



Flush mounting possibilities at both ends of the E-Tube

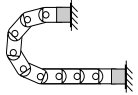

Hole patterns flange steel mounting brackets 905.050.X (X = Bi)

905.050.X (X = Bi)  
Moving end

905.050.X (X = Bi)  
Fixed end

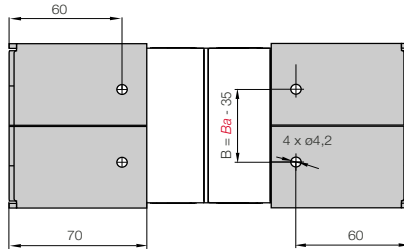
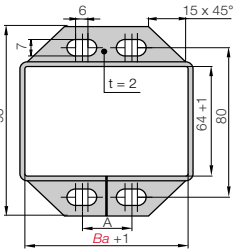

**Dimensions and order configurations**

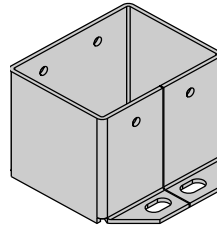

Principle sketch flange steel mounting brackets



Mounting only with hexagon socket DIN 912 M6 and washer DIN 125, 6,3 mm

For Series	Hole pattern	Part No. full set	Bi [mm]	Ba [mm]	Dim. A [mm]	Dim. B [mm]
R168.075	▶ 68.01	905.050.1	75	93	30	58
R168.115	▶ 68.02	905.050.2	115	133	50	98
R168.175	▶ 68.03	905.050.3	175	193	100	158

Phone +49- (0) 22 03-96 49-800  
Fax +49- (0) 22 03-96 49-222

**R100 | Serie R167·R168 | Accessories | Strain Relief**

**NEW Strain relief separator**

Separator with integrated strain relief, for use in the first or last chain link. For manufacturing of switchgear cabinets or for the assembly of machines. Easy to assemble without any fastening device. Separator base 1658.01.Z is 22 mm wide. The possible number of separators per E-Chain® is defined by its inner width Bi and by the cable-diameter. **Details ▶ chapter 10**

Part No.	Number of teeth	For Series
1658.01.Z	4 both sides	R167/168 E-Tube

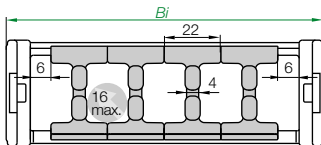

**Strain Relief Separator** - The number of separators is depending on the cables and the available inner space. Example: E-Chain® inner width Bi 100 mm: 4 Strain Relief Separator, max. cable diameter 16 mm. **Details ▶ chapter 10**

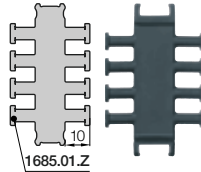

Other strain relief elements  
▶ chapter 10



▶ chapter 10



▶ page 6.5



Price index



UL94-V2 classifications  
upon request



ESD classification:  
Electrically conductive  
ESD/ATEX version upon request



To open the E-Tube Series R lift up the lid  
(with a screwdriver) and remove the lid

- ❶ Protection for cables and hoses, against hot chips
- ❷ Removable lids along outer radius
- ❸ Large pins for high stability
- ❹ Smooth, chip-repellent exterior
- ❺ Small pitch for low-noise, smooth operation
- ❻ Fully enclosed
- ❼ KMA mounting brackets with attachment capability on all sides
- ❽ **Strain relief separator** - Separator with integrated strain relief for the use in the first or last chain link ► [page 6.32](#)



#### When to use the Series R48:

- If particularly quiet operation is required
- At very high speed
- If chip-repellent features are required



#### When not to use it:

- If a particularly low-cost solution is the main factor
  - [Series R117/R118, page 6.6](#)
- If no chip protection is required
  - [Series 2400/2500 E2/000, page 5.94](#)



#### Order example complete E-Tube

Please indicate E-Tube-lengths or number of links **Example: 1 m or 33 links**

1 m **48.075.060.0**



E-Tube

with 2 separators **482** assembled every 2<sup>nd</sup> link



Interior separation

1 set **480.075.12**



Mounting bracket

**Unsupported length**

$FL_G$  = with straight upper run

$FL_B$  = with permitted sag

Further information ► **Design, page 1.12**

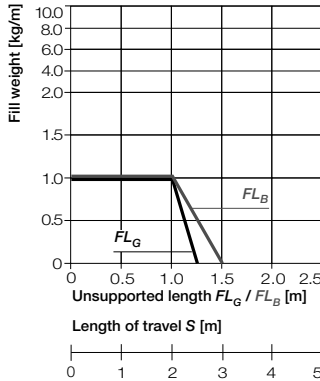
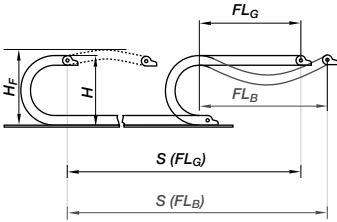

- $S$  = Length of travel
- $R$  = Bending radius
- $H$  = Nominal clearance height
- $H_f$  = Required clearance height
- $D$  = Overlength E-Chain® radius in final position
- $K = \pi \cdot R + \text{"safety"}$

**Other installation methods**

- Vertical, hanging  $\leq 50$  m
- Vertical, standing  $\leq 4$  m
- Side mounted, un supp.  $\leq 1,5$  m
- Rotary requires further calculation
- Unsupported length of upper run = upon request

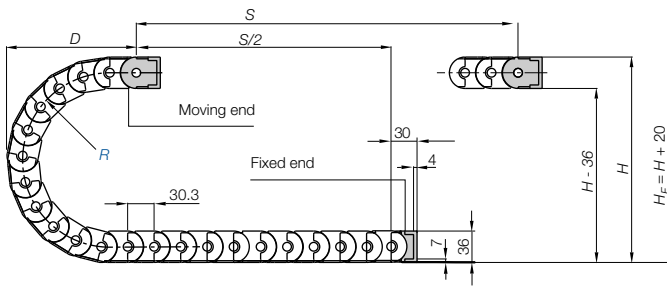

**Pitch = 30,3 mm/link    Links/m = 33 (999,9 mm)    Chain length =  $S/2 + K$**

$R$	060	075	100	125	150	175	200	250
$H$	156	186	236	286	336	386	436	536
$D$	110	125	150	175	200	225	250	300
$K$	250	300	375	455	535	610	690	850

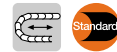

**Short travels - unsupported**

Unsupported E-Chains® feature positive camber over short travels. This must be accounted for when specifying the clearance height  $H_f$ . Please consult igus® if space is particularly restricted.

The required clearance height:  
 **$H_f = H + 20$  mm**  
 (with 0,5 kg/m fill weight)

**Hot Chips up to 850°C**

**E-Tubes that repel hot chips, up to 850 °C**

Some applications, depending on amount and size of the chips, can burn or melt the surface. That is no longer the case with the new igus® "igumid HT" material.

Further Information: [www.igus.de/en/HT](http://www.igus.de/en/HT)



Speed / acceleration $FL_G$	max. 10 [m/s] / max. 100 [m/s²]
Speed / acceleration $FL_B$	max. 3 [m/s] / max. 6 [m/s²]
Gliding speed / acceleration (maximum)	max. 3 [m/s] / max. 10 [m/s²]
Material - permitted temperature °C	igumid G / -40° up to +130° C
Flammability class, igumid G	VDE 0304 IIC UL94 HB

**Technical Data**



Details of material properties  
 ► page 1.38



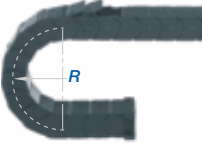
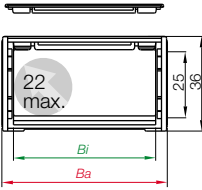

Part No. structure

48. 100. 100. 0



Series R48 - snap-open along outer radius

Part No.	Bi [mm]	Ba [mm]	R [mm]	Bending radii								Weight [kg/m]
48.025.□.0	25	36	060	075	100	125	150	175	200	250	~ 0,64	
48.050.□.0	50	61	060	075	100	125	150	175	200	250	~ 0,84	
48.075.□.0	75	86	060	075	100	125	150	175	200	250	~ 1,03	
48.100.□.0	100	111	060	075	100	125	150	175	200	250	~ 1,23	
48.130.□.0	130	141	060	075	100	125	150	175	200	250	~ 1,46	

Supplement Part No. with required radius. Example: 48.100.□00□.0

0 = standard color, other colors ▶ page 1.39 - Pitch = 30,3 mm/link - Links/m = 33



E2 E-Tubes | R | Series R48 | Accessories | Interior Separation

Vertical Separator

unassembled	481
assembled	482



Strain Relief Separator

unassembled	481.ZR
assembled	482.ZR



Option 1: Vertical Separators

Vertical Separators are used if a vertical subdivision of the E-Chain® interior is required -

By standard Vertical Separators are assembled every other E-Chain® link

- Standard subdivision with Vertical Separator 482
- Strain Relief Separator 482.ZR, integrable in the mounting bracket, to position at any point

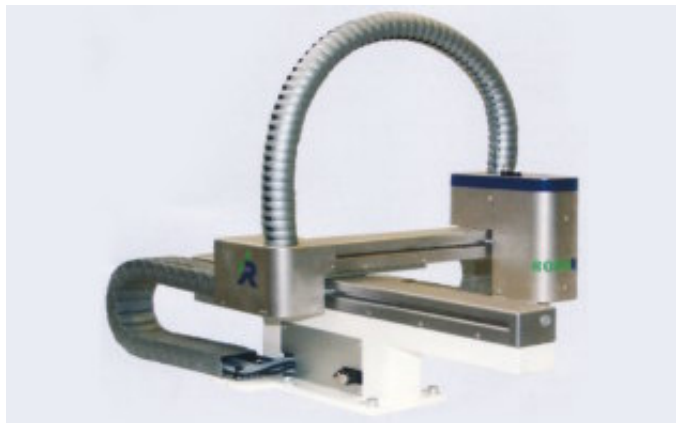
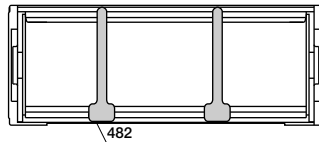

3-axis robot for loading and unloading functions with closed E2 E-Tube R48 and easy to fill igus® 3D E-Chain® Triflex® R (TRE). Accelerations of up to 10m/s². Speed of up to 1,1 m/s



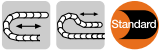

**Option KMA\* - pivoting**

- Recommended for unsupported applications
- Bolted connection outside of chain cross-section possible
- Space-restricted
- Universal mountable with attachment capability on all sides
- Mounting-surfaces can be used on the upper side or front-sided

\*KMA = Polymer Metal Mounting Bracket

Moving end (outer link)  
480...1

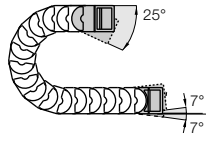

480...2

Fixed end (inner link)



The attachment variants arising automatically by the choice of the KMA mounting bracket

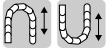
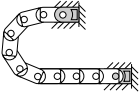

**Option KMA - locking**

- Recommended for vertical hanging / standing applications
- Bolted connection outside of chain cross-section possible
- At very high speed and acceleration
- Universal mountable with attachment capability on all sides
- Mounting-surfaces can be used on the upper side or front-sided

Moving end (outer link)  
485...1

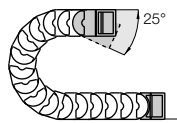

485...2

Fixed end (inner link)



The attachment variants arising automatically by the choice of the KMA mounting bracket

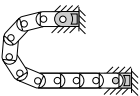

480...1 (pivoting)  
485...1 (locking)  
Moving end

(pivoting) 480...2  
(locking) 485...2  
Fixed end

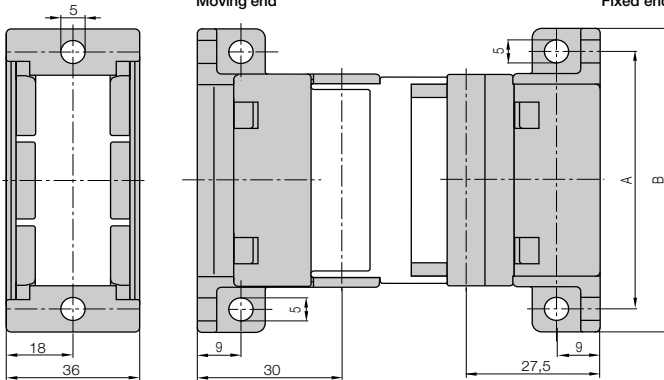

**Dimensions and order configurations**

Part No. structure (pivoting)

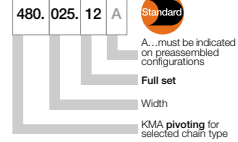

Full set, for both ends:

480.025.12

Single-part order:

480.025.1

Mounting bracket with bore

480.025.2

Mounting bracket with pin

Part No. structure (locking)

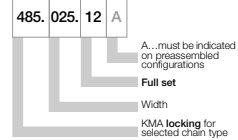

Full set, for both ends:

485.025.12

Single-part order:

485.025.1

Mounting bracket with bore

485.025.2

Mounting bracket with pin

Please add the Part No. with the requested index - 480 for the pivoting configuration

e.g. 480.025.12 or 485 for the locking configuration e.g. 485.025.12

For the preassembled mode please add the index A e.g. 480.025.12 A

The following parts are required for attachment of the mounting brackets:

- Socket head cap bolt M5 DIN 912-8.8 Length depends on the thickness of the attachment base
- Washer 5,3 DIN 125-ST ● Hexagon nut M5 DIN 934-8



Strain relief separator for the use in the first or last chain link ► page 6.32



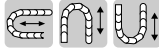

### Steel mounting bracket

- Locked connection to E-Tube
- Electrically conductive
- Minimized external width

Moving end (outer link)  
482...1

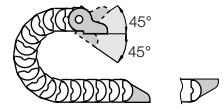

482...2

Fixed end (inner link)

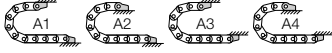

Possible installation conditions -

Further installation angles ► installation sketch

## Dimensions and order configurations

482...1

Moving end

482...2

Fixed end

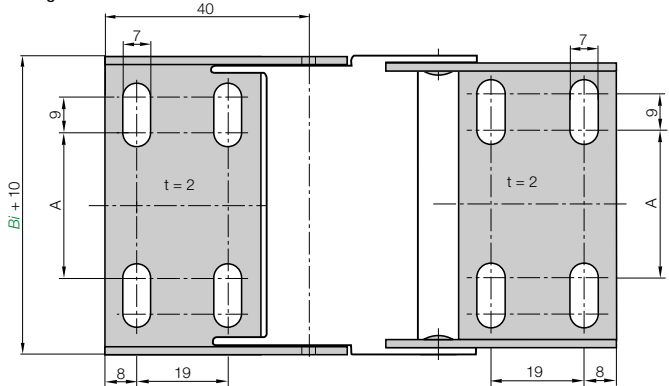

Part No. structure

482.050.12.A1

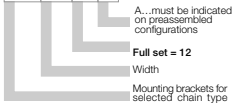

A... must be indicated on preassembled configurations  
Full set = 12  
Width  
Mounting brackets for selected chain type

Full set, for both ends:

482.050.12

Single-part order:

482.050.1

Mounting bracket with bore

482.050.2

Mounting bracket with pin

For Series	Part No. full set	Dim. A [mm]
48.025. ►	482.025.12	-
48.050. ►	482.050.12	22
48.075. ►	482.075.12	47
48.100. ►	482.100.12	72
48.130. ►	482.130.12	102

Please add the Part No. with the requested index - e.g. 482.050.12A1

For the preassembled mode please add the index A1...A4 e.g. 482.050.12A1

The following parts are required for attachment of the mounting brackets:

- Socket head cap bolt M5 DIN 912-8.8 Length depends on the thickness of the attachment base
- Washer 5,3 DIN 125-ST ● Hexagon nut M5 DIN 934-8

Phone +49- (0) 22 03-96 49-800  
Fax +49- (0) 22 03-96 49-222

igus® GmbH  
51147 Cologne

Internet: www.igus.de  
E-mail: info@igus.de



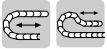

**Angled polymer bracket**

- Attachment option for strain relief tiewrap plate
- Locked connection to E-Tube
- Minimized external width

Moving end (outer link)  
4800...1(PZB)

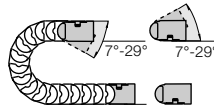

4800...2(PZB)  
Fixed end (inner link)

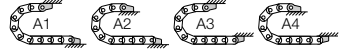

Possible installation conditions for assembled mounting brackets ▶ Order example "preassembled" below

4800...1(PZB)  
Moving end

4800 ...2(PZB)  
Fixed end

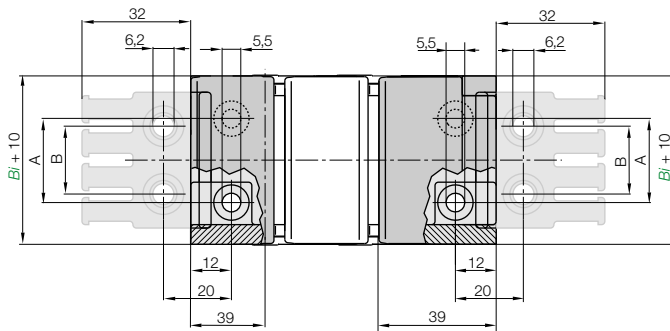

**Dimensions and order configurations**

Strain relief is possible on the moving end and/or the fixed end.

For Series	Part No. Full set with tiewrap plates	Part No. Full set without tiewrap plates	Dim. A [mm]	Dim. B [mm]
48.025. ▶	4800. [ ] .12PZB	4800. [ ] .12	12	15
48.050. ▶	4800. [ ] .12PZB	4800. [ ] .12	37	30
48.075. ▶	4800. [ ] .12PZB	4800. [ ] .12	62	60
48.100. ▶	4800. [ ] .12PZB	4800. [ ] .12	87	80
48.130. ▶	-	4800. [ ] .12	117	-

Please add the Part No. with the requested index - e.g. 4800. [050] .12 PZBA1

For the preassembled mode please add the index [A1] ... [A4] e.g. 4800. [050] 12PZB [A1]

The following parts are required for attachment of the mounting brackets:

- Countersunk bolt M5 DIN 912-8.8 Length depends on the thickness of the attachment base
- Hexagon nut M5 DIN 934-8

**Part No. structure**

4800.025. 12 PZB A1

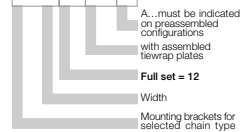

Full set, for both ends:

4800.025. 12 PZB

Single-part order:

4800.025. 1 PZB

Mounting bracket with bore

4800.025. 2 PZB

Mounting bracket with pin

Phone +49- (0) 22 03-96 49-800  
Fax +49- (0) 22 03-96 49-222



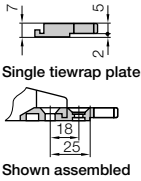
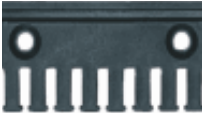

### Tiewrap plate as individual part

As individual component screwed on KMA. Can be plugged in the mounting brackets. **Details ► chapter 10**

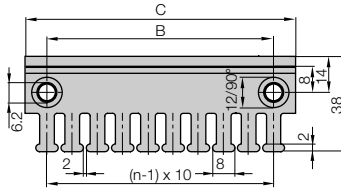

Tiewrap plate	No. of teeth $n$	Dim. C [mm]	Dim. B [mm]
2020.ZB	3	30	15
2030.ZB	4	40	20
2040.ZB	5	50	30
2050.ZB	6	60	40
2070.ZB	8	80	60
2090.ZB = (2030.ZB + 2040.ZB)	9	90	–
2100.ZB	10	100	80
2125.ZB = (2050.ZB + 2050.ZB)	12	120	–



### Cable tiewraps as individual part

Cable tiewraps (100-piece bag)	Width x length	max. Ø	Tensile strength
CFB.001	4,8 x 150 mm	36 mm	222 N

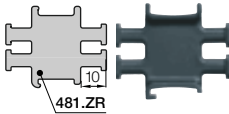

### NEW Strain relief separator

Separator with integrated strain relief, for use in the first or last chain link. For manufacturing of switchgear cabinets or for the assembly of machines. Easy to assemble without any fastening device. Separator base 481.ZR is 10 mm wide. The possible number of separators per E-Chain® is defined by its inner width  $B_i$  and by the cable-diameter. **Details ► chapter 10**

Part No.	Number of teeth	For Series
481.ZR	2 both sides	R48 E-Tube

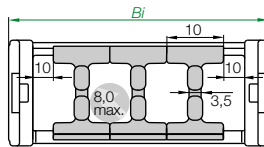

**Strain Relief Separator** - The number of separators is depending on the cables and the available inner space. Example: E-Chain® inner width  $B_i$  50 mm: 3 Strain Relief Separator, max. cable diameter 8 mm. **Details ► chapter 10**



Other strain relief elements  
 ► chapter 10

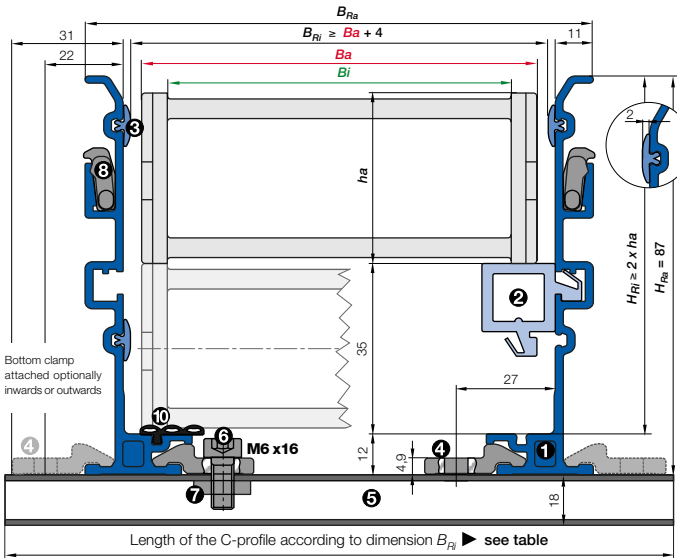

- $B_a$  = Outer width E-Chains® / E-Tube
  - $B_i$  = Inner width E-Chains® / E-Tube
  - $ha$  = Outer height E-Chains® / E-Tube
  - $H_{Ri}$  = Inner trough height
  - $H_{Ra}$  = Outer trough height
  - $B_{Ri}$  = Inner trough width ► depends on dim.  $B_a$
  - $B_{Ra}$  = Outer trough width
  - $n_{Mon}$  = Number of installation sets (left/right)
  - $n_{Ri}$  = Number of troughs sets (left/right)
  - $H_{Ri} \geq 2 \cdot ha$
  - $B_{Ri} \geq B_a + 4$
- = Guide trough set
  - = Installation set "Basic"
  - = C-profile
  - = Glide bar

**Installation set "Basic" with C-profile**

Bottom Clamp attached optionally inwards or outwards

48.100.075.0 ► Order example

$B_{Ri}$ [mm]	Part No.	
	attached inwards	attached outwards
.025 40	-	960.30.150
.050 65	-	960.30.175
.075 90	960.30.150	960.30.200
.100 115	960.30.175	960.30.225
.130 145	960.30.200	960.30.250



- **Components, trough "Basic":** ① Trough side parts, aluminum, 2 m ② Glide bar, plastic, 2 m ③ Glide strips, plastic, 2 m (without glide strips on request) ⑩ Optional: Silencer profile, rubber
- **Components, installation set "Basic":** ④ Bottom clamp, aluminum ⑤ C-profile, steel galvanized ⑥ Screw M6 x16 ⑦ Sliding nut M6 ⑧ Interface connector, plastic



**Order example: Length of travel 30 m - Center mounted for Series 48.100.0750.0 with  $B_{Ri} = 175$**

- Guide trough set (set of 2 trough side parts, incl. glide strips) **without** glide bar
- Order text: 16 m guide trough without glide bar (8 x 2 m sections) Part No. 971.30.SL**
- Guide trough set (set of 2 trough side parts, incl. glide strips) **with** glide bar
- Order text: 16 m guide trough with glide bar (8 x 2 m sections) Part No. 971.31.SL**
- Installation set "Basic" complete (guide trough-sets + 1)
- Order text: 17 installation sets "Basic" Part No. 960.30.150**
- Option:** For an additional noise dampening with silencer profile, please add Index A - Example: **Part No. 971.30.SLA**



Principle sketch: Number of installation sets to be installed = **Number of trough sections + 1**

**Other guide trough systems**



"Heavy Duty" for the fastidiously construction with glide bar and silencer profiles  
 ► chapter 9

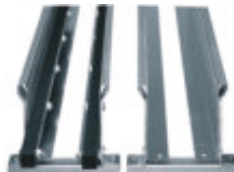

"Steel trough" very stable and robust guide trough out of steel, 2 pieces, adjustable on chain width  
 ► chapter 9

Insert for the installation set "Heavy Duty": **971.50.XXX** instead of **(960.30.XXX)** on the right column "attached outwards"

Phone +49- (0) 22 03-96 49-800  
 Fax +49- (0) 22 03-96 49-222



► chapter 10



► chapter 9



► page 6.5



Price index



UL94-V2 classifications  
upon request



ESD classification:  
Electrically conductive  
ESD/ATEX version upon request



To open the E-Tube Series R lift up the lid  
(with a screwdriver) and remove the lid

- ❶ Protection for cables and hoses,  
against hot chips
- ❷ Large pins for high stability
- ❸ Removable lids along outer radius
- ❹ Smooth, chip-repellent exterior
- ❺ Small pitch for low-noise, smooth operation
- ❻ Fully enclosed
- ❼ KMA mounting brackets with  
attachment capability on all sides
- ❽ Small pitch enables very small radii
- ❾ Integrated strain relief available  
especially for E-Tubes ► [page 6.40](#)

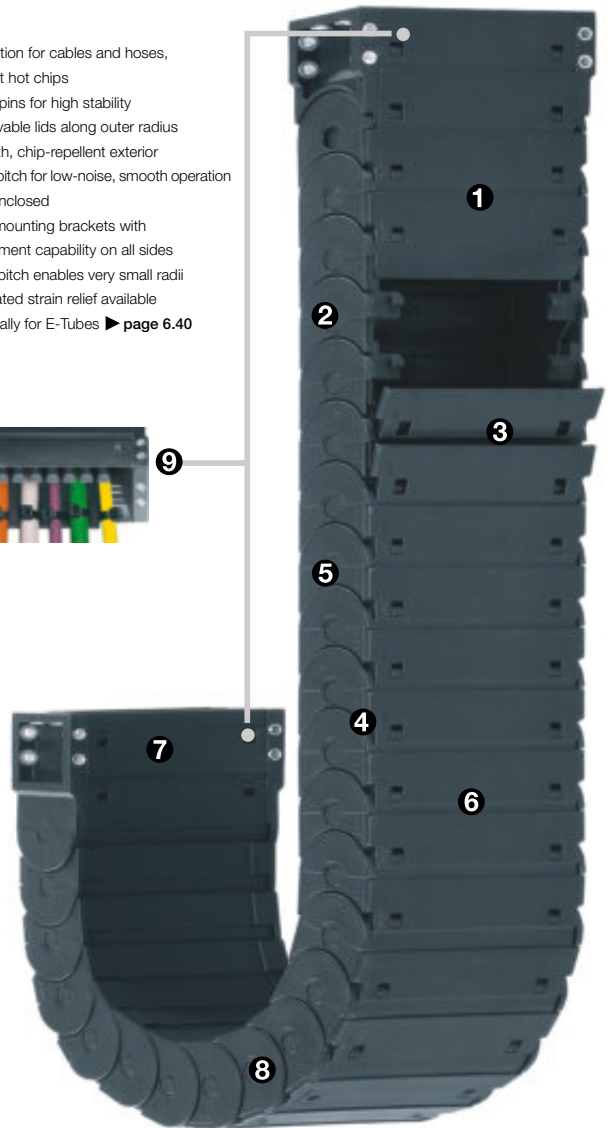

When to use the Series R58:

- If particularly quiet operation is required
- At very high speed
- If chip protection is subject  
to stringent requirements



When not to use it:

- If a particularly low-cost solution  
is the main factor  
► [Series R157/158, page 6.12](#)



Order example complete E-Tube

Please indicate E-Tube-lengths or number of links Example: 1 m or 56 links

1 m **58.100.100.0**



E-Tube

with 2 separators **582** assembled every 2<sup>nd</sup> link



Interior separation

1 set **580.100.12**



Mounting bracket

**Unsupported length**

$FL_G$  = with straight upper run

$FL_B$  = with permitted sag

Further information ► **Design, page 1.12**

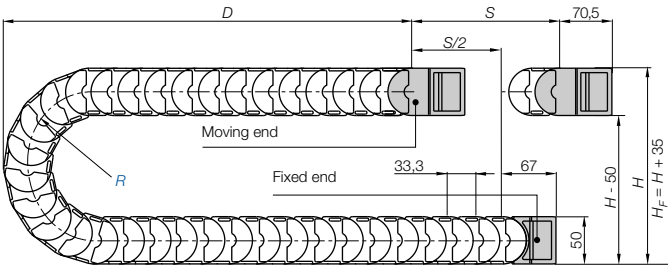
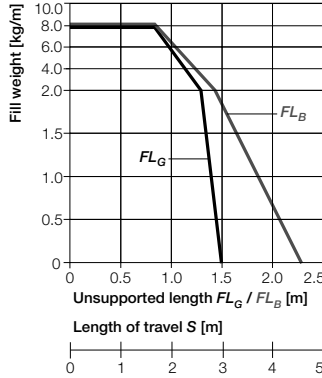
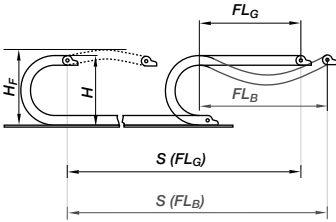

Pitch = 33,3 mm/link    Links/m = 30 (999 mm)    Chain length =  $S/2 + K$

<b>R</b>	075	100	125	150	200	250
<b>H</b>	200	250	300	350	450	550
<b>D</b>	150	175	200	225	275	325
<b>K</b>	375	475	550	650	825	925

- S** = Length of travel
- R** = Bending radius
- H** = Nominal clearance height
- H<sub>F</sub>** = Required clearance height
- D** = Overlength E-Chain® radius in final position
- K** =  $\pi \cdot R +$  "safety"

**Other installation methods**

- Vertical, hanging  $\leq 50$  m
- Vertical, standing  $\leq 4$  m
- Side mounted, un supp.  $\leq 2$ m
- Rotary requires further calculation
- Unsupported length of upper run = upon request

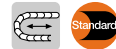

**Short travels - unsupported**

Unsupported E-Chains® feature positive camber over short travels. This must be accounted for when specifying the clearance height  $H_F$ . Please consult igus® if space is particularly restricted.

The required clearance height:  
 **$H_F = H + 35$  mm**  
 (with 0,5 kg/m fill weight)

**Hot Chips up to 850°C**

**E-Tubes that repel hot chips, up to 850 °C**

Some applications, depending on amount and size of the chips, can burn or melt the surface. That is no longer the case with the new igus® "igumid HT" material.

Further Information: [www.igus.de/en/HT](http://www.igus.de/en/HT)



Speed / acceleration $FL_G$	max. 10 [m/s] / max. 100 [m/s²]
Speed / acceleration $FL_B$	max. 3 [m/s] / max. 6 [m/s²]
Gliding speed / acceleration (maximum)	max. 3 [m/s] / max. 10 [m/s²]
Material - permitted temperature °C	igumid G / -40° up to +130° C
Flammability class, igumid G	VDE 0304 IIC UL94 HB

**Technical Data**



Details of material properties  
 ► page 1.38





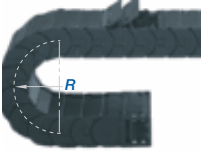
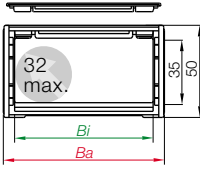

Part No. structure

58. 100. 100. 0



## Series R58 - snap-open along outer radius

Part No.	$B_i$ [mm]	$B_a$ [mm]	$R$ [mm]	Bending radii					Weight [kg/m]
58.050.□.0	50	66	075	100	125	150	200	250	~ 1,50
58.075.□.0	75	91	075	100	125	150	200	250	~ 1,77
58.100.□.0	100	116	075	100	125	150	200	250	~ 2,04
58.125.□.0	125	141	075	100	125	150	200	250	~ 2,31
58.150.□.0	150	166	075	100	125	150	200	250	~ 2,61
58.175.□.0	175	191	075	100	125	150	200	250	~ 2,88
58.200.□.0	200	216	075	100	125	150	200	250	~ 3,15

Supplement Part No. with required radius. Example: 58.100.□00.0

0 = standard color, other colors ► page 1.39 - Pitch = 33,3 mm/link - Links/m = 30



Phone +49- (0) 22 03-96 49-800  
 Fax +49- (0) 22 03-96 49-222

igus® GmbH  
 51147 Cologne

Internet: [www.igus.de](http://www.igus.de)  
 E-mail: [info@igus.de](mailto:info@igus.de)

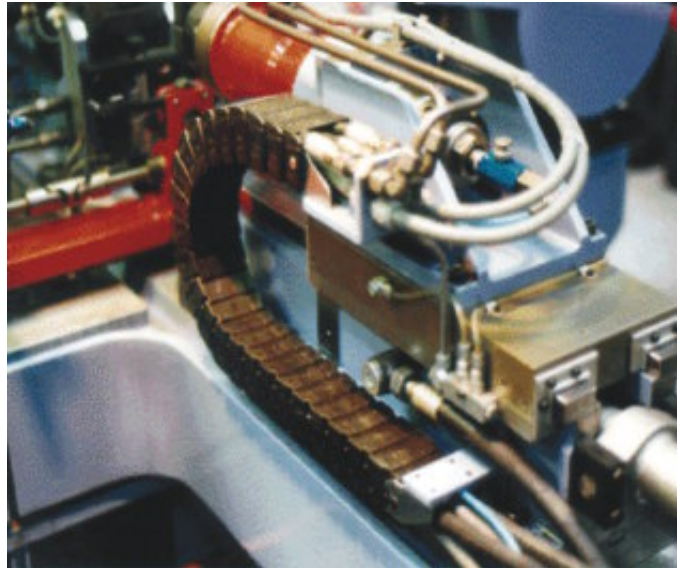

E-Tubes series are suitable for small installation space and high speeds as well. Here pre-harnessed with hydraulic hoses and special parts

### Option 1: Vertical Separators

Vertical Separators are used if a vertical subdivision of the E-Chain® interior is required -

By standard Vertical Separators are assembled every other E-Chain® link

- Standard subdivision with Vertical Separator 582

Vertical Separator	
unassembled	581
assembled	582

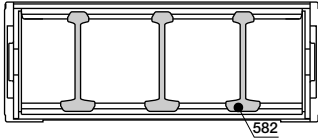

E2 E-Tubes Type R  
Inner height: 35 mm

### Option 2: Full-Width Shelves

For applications involving many thin cables with similar or identical diameters

- Vertical Separator, slotted 588 can be combined with Full-Width Shelf 221.X

Vert. Separator, slotted	
unassembled	587
assembled	588

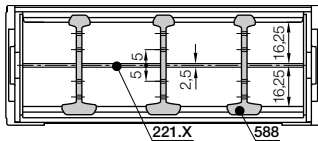

Width X [mm]	Part No. unassembled	Part No. assembled
50	220.50	221.50
75	220.75	221.75
100	220.100	221.100
125	220.125	221.125

Width X [mm]	Part No. unassembled	Part No. assembled
150	220.150	221.150
175	220.175	221.175
200	220.200	221.200

Full-Width Shelf

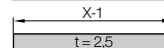

Phone +49- (0) 22 03-96 49-800  
Fax +49- (0) 22 03-96 49-222

### Option 3: Shelves

For applications involving many cables with similar or identical diameters. Partial separation into individual chambers can be achieved and the entire width Bi-10 mm can be used

- Shelf 2210.X can be combined with Middle Plate 586

Middle Plate	
unassembled	585
assembled	586

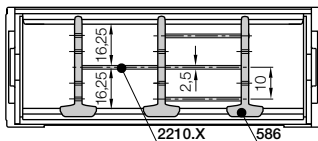

Width X [mm]	Part No. unassembled	Part No. assembled
18	2200.18	2210.18
23	2200.23	2210.23
28	2200.28	2210.28
33	2200.33	2210.33
38	2200.38	2210.38
43	2200.43	2210.43
48	2200.48	2210.48

Width X [mm]	Part No. unassembled	Part No. assembled
58	2200.58	2210.58
68	2200.68	2210.68
73	2200.73	2210.73
88	2200.88	2210.88
99	2200.99	2210.99
124	2200.124	2210.124
149	2200.149	2210.149

Shelf

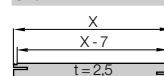

▶ page 6.5

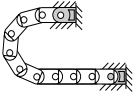

The attachment variants arising automatically by the choice of the KMA mounting bracket



**Option KMA\* - pivoting**

- Option - KMA with Quickflange for short and long travels
- Recommended for unsupported and gliding applications
- Space-restricted
- Universal mountable with attachment capability on all sides

\*KMA = Polymer Metal Mounting Bracket

Moving end (outer link)  
580...1

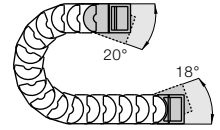

580...2

Fixed end (inner link)

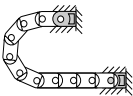

The attachment variants arising automatically by the choice of the KMA mounting bracket

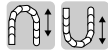

**Option KMA - locking**

- Option - KMA with Quickflange
- Recommended for vertical hanging / standing applications
- At very high speed and acceleration
- Universal mountable with attachment capability on all sides
- Flush mounting at both ends of the E-Tube

Moving end (outer link)  
580...3

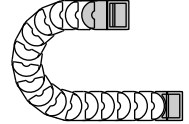

580...4

Fixed end (inner link)

**Dimensions and order configurations**

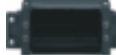

Quickflange upon request

**Part No. structure (pivoting)**

580.050.12 A



A... must be indicated on preassembled configurations  
Full set pivoting = 12  
Width  
KMA for selected chain type

**Full set, for both ends:**

580.050.12

**Single-part order:**

580.050.1

**Mounting bracket with bore**

580.050.2

**Mounting bracket with pin**

**Part No. structure (locking)**

580.050.34 A

A... must be indicated on preassembled configurations  
Full set locking = 34  
Width  
KMA for selected chain type

**Full set, for both ends:**

580.050.34

**Single-part order:**

580.050.3

**Mounting bracket with bore**

580.050.4

**Mounting bracket with pin**

**Quickflange**

Part No. 16800.QF, unassembled

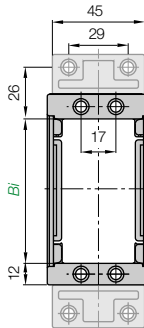

**580...2 Standard! (pivoting)**

580...4 (locking)

Fixed end

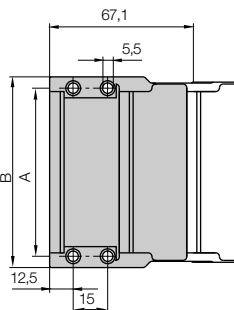

**Standard! (pivoting) 580...1**

(locking) 580...3

Moving end

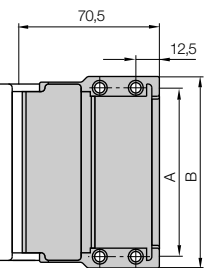

For Series	Part No. Full set	Part No. Full set with Quickflange	Dim. A [mm]	Dim. B [mm]
58.050.	580.050. [ ]	580.050. [ ] QF	62	74
58.075.	580.075. [ ]	580.075. [ ] QF	87	99
58.100.	580.100. [ ]	580.100. [ ] QF	112	124
58.125.	580.125. [ ]	580.125. [ ] QF	137	149
58.150.	580.150. [ ]	580.150. [ ] QF	162	174
58.175.	580.175. [ ]	580.175. [ ] QF	187	199
58.200.	580.200. [ ]	580.200. [ ] QF	212	224

Please add the Part No. with the requested index - 12 for the pivoting configuration

e.g. 580.100.12 or 34 for the locking configuration e.g. 580.100.34

For the preassembled mode please add the index A e.g. 580.100.34 A

Quickflange unassembled: Part No. 16800.QF

The following parts are required for attachment of the mounting brackets:

- Socket head cap bolt M5 DIN 912-B.8 Length depends on the thickness of the attachment base
- Washer 5,3 DIN 125-ST ● Hexagon nut M5 DIN 934-8



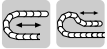

**Flange mounting brackets made of steel**

- Metallic flange brackets with popular hole patterns, easily be replaced by their modern successors, without having to alter the hole pattern
- Bolted connection outside of chain cross-section possible
- Universal mountable with attachment capability on all sides
- Steel, galvanized
- One-piece mounting bracket
- High stability

**Moving end (outer link)**  
906.463.X.1 (X = Bi)

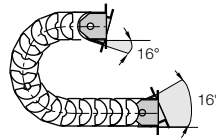

**906.463.X.2 (X = Bi)**  
**Fixed end (inner link)**



Flush mounting possibilities at both ends of the E-Tube

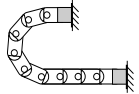

906.463.X.1 (X = Bi)

**Moving end**

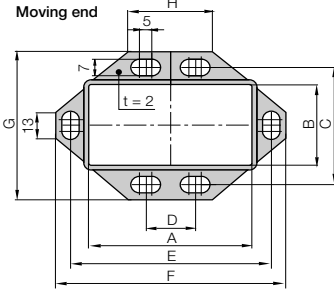

**Hole pattern metallic flange**  
**Moving end 906.463.X.1**

906.463.X.2 (X = Bi)

**Fixed end**

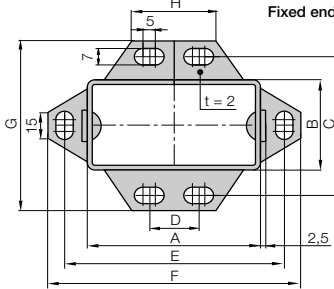

**Hole pattern metallic flange**  
**Fixed end 906.463.X.2**

**Dimensions and order configurations**

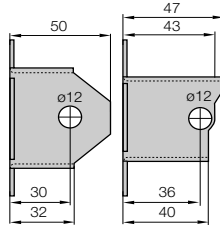

**Moving end**  
906.463.X.1

**Fixed end**  
906.463.X.2

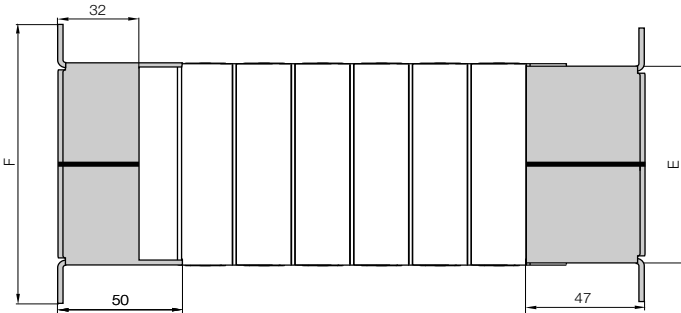

Full set, for both ends:

906.463. **Bi** | 12

Single-part order:

906.463. **Bi** | 1

Mounting bracket with bore

906.463. **Bi** | 2

Mounting bracket with pin

For Series	Hole pattern	Part No. Moving end	Part No. Fixed end	Bi (X) [mm]	Ba [mm]	Dim. A [mm]	Dim. B [mm]	Dim. C [mm]	Dim. D [mm]	Dim. E [mm]	Dim. F [mm]	Dim. G [mm]	Dim. H [mm]
R58.050	► 58.05	906.463.05.1	906.463.05.2	50	66	58,3	48	68	20	78,5	90,5	82	24,5
R58.075	► 58.1	906.463.1.1	906.463.1.2	75	91	83,3	48	68	30	104	116	82	50

Phone +49- (0) 22 03-96 49-800  
Fax +49- (0) 22 03-96 49-222





### Integrated strain relief for E2 E-Tubes - Series R

**Characteristic features:** ● Strain relief disappears completely in the E-Tube ● Easy to assemble without any screws ● **Use:** Individual part for the manufacturing of switchgear cabinets or for the assembly of machines ● Accessory for igus® E-ChainSystems®

Part. No.	Width [mm]	Number of teeth	For Series
5850.Z	46	4	R58

### Number of tiewrap plates 5850.Z for selected inner width $B_i$

$B_i$ [mm]	Width tiewrap plate [mm]	Number of tiewrap plate $n$
50	46	–
75	46	1
100	46	1
125	46	2
150	46	2
175	46	3
200	46	3

Phone +49- (0) 22 03-96 49-800  
Fax +49- (0) 22 03-96 49-222

igus® GmbH  
51147 Cologne

Internet: [www.igus.de](http://www.igus.de)  
E-mail: [info@igus.de](mailto:info@igus.de)



Other strain relief elements

► chapter 10

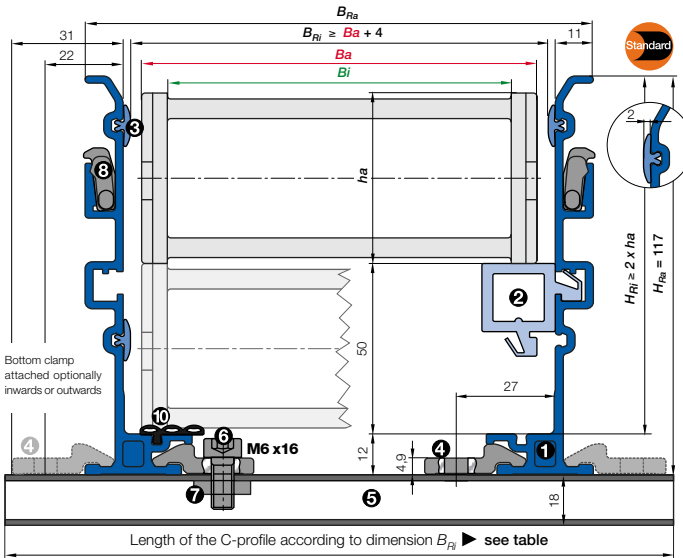

- $B_a$  = Outer width E-Chains® / E-Tube
  - $B_i$  = Inner width E-Chains® / E-Tube
  - $h_a$  = Outer height E-Chains® / E-Tube
  - $H_{Ri}$  = Inner trough height
  - $H_{Ra}$  = Outer trough height
  - $B_{Ri}$  = Inner trough width ▶ depends on dim.  $B_a$
  - $B_{Ra}$  = Outer trough width
  - $n_{Mon}$  = Number of installation sets (left/right)
  - $n_{Ri}$  = Number of trough sets (left/right)
  - $H_{Ri} \geq 2 \cdot h_a$
  - $B_{Ri} \geq B_a + 4$
- = Guide trough set
  - = Installation set "Basic"
  - = C-profile
  - = Glide bar

**Installation set "Basic" with C-profile**

Bottom Clamp attached optionally inwards or outwards

58.075.200.0 ▶ Order example

$B_{Ri}$ [mm]	Order example	
	attached inwards	attached outwards
.050 70	-	960.30.175
.075 95	960.30.150	960.30.200
.100 120	960.30.175	960.30.225
.125 145	960.30.200	960.30.250
.150 170	960.30.225	960.30.275
.175 195	960.30.250	960.30.300
.200 220	960.30.275	960.30.325



- **Components, trough "Basic":** ① Trough side parts, aluminum, 2 m ② Glide bar, plastic, 2 m ③ Glide strips, plastic, 2 m (without glide strips on request) ⑩ Optional: Silencer profile, rubber
- **Components, installation set "Basic":** ④ Bottom clamp, aluminum ⑤ C-profile, steel galvanized ⑥ Screw M6 x16 ⑦ Sliding nut M6 ⑧ Interface connector, plastic

**Order example: Length of travel 30 m - Center mounted for Series 58.075.200.0 with  $B_{Ri} = 95$**

- Guide trough set (set of 2 trough side parts, incl. glide strips) **without** glide bar  
**Order text: 16 m guide trough without glide bar (8 x 2 m sections) Part No. 972.30.SL**
- Guide trough set (set of 2 trough side parts, incl. glide strips) **with** glide bar  
**Order text: 16 m guide trough with glide bar (8 x 2 m sections) Part No. 972.32.SL**
- Installation set "Basic" complete (guide trough-sets + 1)  
**Order text: 17 installation sets "Basic" Part No. 960.30.150**
- Option:** For an additional noise dampening with silencer profile, please add Index A - Example:  
**Part No. 972.30.SLA**

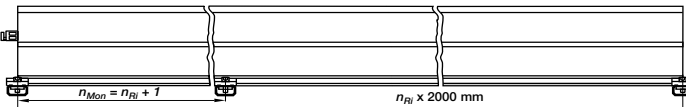

Principle sketch: Number of installation sets to be installed = **Number of trough sections + 1**

**Other guide trough systems**



"Heavy Duty" for the fastidiously construction with glide bar and silencer profiles  
 ▶ chapter 9



"Steel trough" very stable and robust guide trough out of steel, 2 pieces, adjustable on chain width  
 ▶ chapter 9





Price index



UL94-V2 classifications  
upon request



ESD classification:  
Electrically conductive  
ESD/ATEX version upon request



iF-Design Award Winner  
Series R68



To open the E-Tube Series R lift up the lid  
(with a screwdriver) and remove the lid

- ❶ Protection for cables and hoses,  
against hot chips
- ❷ Large pins for high stability
- ❸ Smooth, chip-repellent exterior
- ❹ Small pitch for low-noise, smooth operation
- ❺ Removable lids along outer radius
- ❻ Fully enclosed
- ❼ KMA mounting brackets with  
attachment capability on all sides
- ❽ Integrated strain relief available  
especially for E-Tubes ► page 6.48

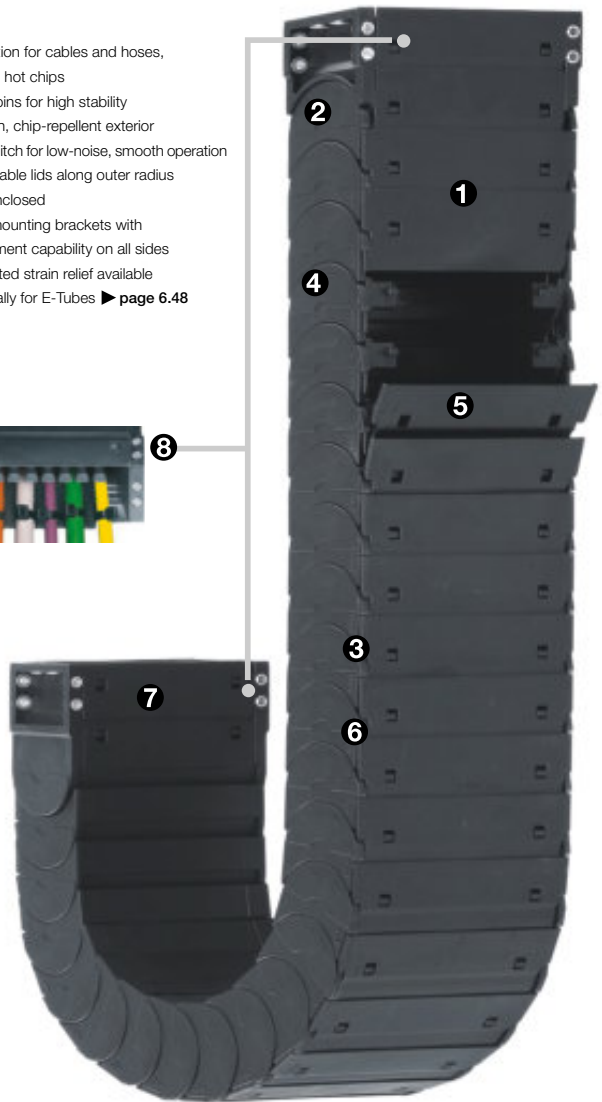

When to use the Series R68:

- If particularly quiet operation is required
- At very high speed
- If chip protection is subject  
to stringent requirements



When not to use it:

- If a particularly low-cost solution  
is the main factor  
► Series R117/R118, page 6.6
- If no chip protection is required  
► Series 2400/2500 E2/000, page 5.94



Order example complete E-Tube

Please indicate E-Tube-lengths or number of links Example: 1 m or 28 links

1 m 68.100.100.0

 E-Tube

with 2 separators 311 assembled every 2<sup>nd</sup> link

 Interior separation

1 set 680.100.12

 Mounting bracket



**Unsupported length**

$FL_G$  = with straight upper run

$FL_B$  = with permitted sag

Further information ► **Design, page 1.12**

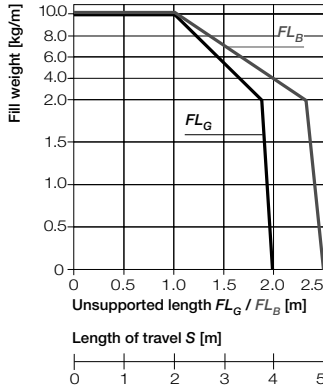
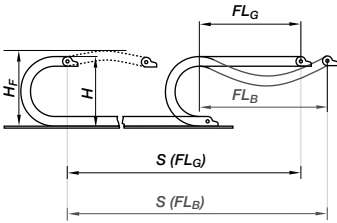

- $S$  = Length of travel
- $R$  = Bending radius
- $H$  = Nominal clearance height
- $H_F$  = Required clearance height
- $D$  = Overlength E-Chain\*  
radius in final position
- $K = \pi \cdot R + \text{"safety"}$

**Other installation methods**

- Vertical, hanging  $\leq 60$  m
- Vertical, standing  $\leq 4$  m
- Side mounted, un supp.  $\leq 2$  m
- Rotary requires further calculation
- Unsupported length of upper run = upon request

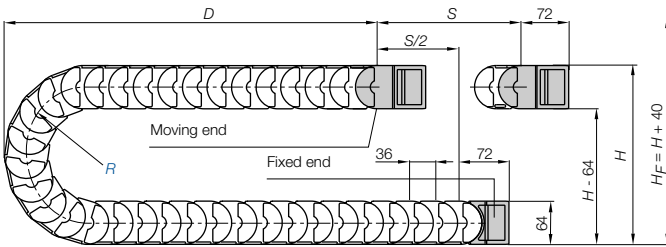

Pitch = 36 mm/link      Links/m = 28 (1008 mm)      Chain length =  $S/2 + K$

$R$	100	125	150	175	200	225	250	300
$H$	265	315	365	415	465	515	565	665
$D$	200	225	250	275	300	325	350	400
$K$	500	650	725	800	875	975	1050	1225



**Short travels - unsupported**

Unsupported E-Chains\* feature positive camber over short travels. This must be accounted for when specifying the clearance height  $H_F$ . Please consult igus\* if space is particularly restricted.

The required clearance height:  
 **$H_F = H + 40$  mm**  
(with 2,5 kg/m fill weight)

45

E2 E-Tubes Type R  
Inner height: 45 mm

Phone +49- (0) 22 03-96 49-800  
Fax +49- (0) 22 03-96 49-222



**Hot Chips up to 850°C**

E-Tubes that repel hot chips, up to 850 °C

Some applications, depending on amount and size of the chips, can burn or melt the surface. That is no longer the case with the new igus® "igumid HT" material.

Further Information: [www.igus.de/en/HT](http://www.igus.de/en/HT)



Speed / acceleration $FL_G$	max. 10 [m/s] / max. 100 [m/s²]
Speed / acceleration $FL_B$	max. 3 [m/s] / max. 6 [m/s²]
Gliding speed / acceleration (maximum)	max. 3 [m/s] / max. 10 [m/s²]
Material - permitted temperature °C	igumid G / -40° up to +130° C
Flammability class, igumid G	VDE 0304 IIC UL94 HB

**Technical Data**



Details of material properties  
► page 1.38

► page 6.5

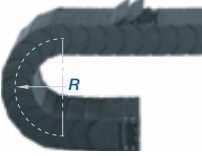
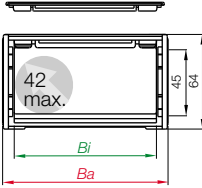

Part No. structure

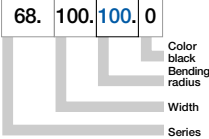

Series R68 - snap-open along outer radius

Part No.	Bi [mm]	Ba [mm]	R [mm]	Bending radii								Weight [kg/m]
68.050.□.0	50	68	100	125	150	175	200	225	250	300	~ 1,90	
68.075.□.0	75	93	100	125	150	175	200	225	250	300	~ 2,18	
68.100.□.0	100	118	100	125	150	175	200	225	250	300	~ 2,46	
68.115.□.0	115	133	100	125	150	175	200	225	250	300	~ 2,63	
68.125.□.0	125	143	100	125	150	175	200	225	250	300	~ 2,77	
68.150.□.0	150	168	100	125	150	175	200	225	250	300	~ 3,05	
68.175.□.0	175	193	100	125	150	175	200	225	250	300	~ 3,36	
68.200.□.0	200	218	100	125	150	175	200	225	250	300	~ 3,64	
68.225.□.0	225	243	100	125	150	175	200	225	250	300	~ 3,92	
68.250.□.0	250	268	100	125	150	175	200	225	250	300	~ 4,23	

Supplement Part No. with required radius. Example: 68.100.100.0

0 = standard color, other colors ▶ page 1.39 - Pitch = 36 mm/link - Links/m = 28



Series R68 works in an apple-sorting-machine: humidity and dirt

### Option 1: Vertical Separators

Vertical Separators are used if a vertical subdivision of the E-Chain® interior is required -

By standard Vertical Separators are assembled every other E-Chain® link

- Standard subdivision with Vertical Separator 311

(if you select bending radius R = 100 please use Vertical Separator 34511)

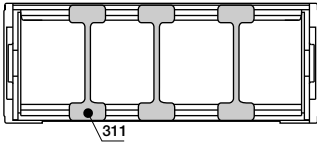

Vertical Separator*	
unassembled	301
assembled	311

\*not suitable for bending radius = 100



Vertical Separator, for bending radius R = 100	
unassembled	34501
assembled	34511



### Option 2: Full-Width Shelves

For applications involving many thin cables with similar or identical diameters

- Vertical Separator, slotted 312 or Vertical Separator, slotted 312.24 with wide base can be combined with Full-Width Shelf 221.X

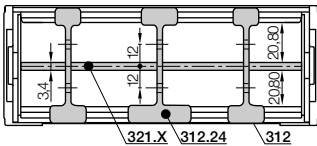

Vert. Separator, slotted	
unassembled	302
assembled	312



Vert. Separator, slotted	
unassembled	302.24
assembled	312.24



Width X [mm]	Part No. unassembled	Part No. assembled
50	320.050	321.050
75	320.075	321.075
100	320.100	321.100
115	320.115	321.115
125	320.125	321.125

Width X [mm]	Part No. unassembled	Part No. assembled
150	320.150	321.150
175	320.175	321.175
200	320.200	321.200
225	320.225	321.225
250	320.250	321.250

#### Full-Width Shelf

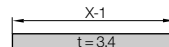

### Option 3: Shelves

For applications involving many cables with similar or identical diameters. Partial separation into individual chambers can be achieved and the entire width Bi-10 mm can be used

- Shelf 2210.X can be combined with Side Plate 313 and Middle Plate 314
- Option 3 "Shelves" can also be combined with option 1 "Vertical Separators"

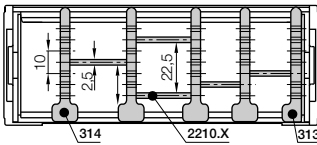

Side Plate	
unassembled	303
assembled	313



Middle Plate	
unassembled	304
assembled	314



Width X [mm]	Part No. unassembled	Part No. assembled
18	2200.18	2210.18
23	2200.23	2210.23
28	2200.28	2210.28
33	2200.33	2210.33
38	2200.38	2210.38
43	2200.43	2210.43
48	2200.48	2210.48

Width X [mm]	Part No. unassembled	Part No. assembled
58	2200.58	2210.58
68	2200.68	2210.68
73	2200.73	2210.73
88	2200.88	2210.88
99	2200.99	2210.99
124	2200.124	2210.124
149	2200.149	2210.149

#### Shelf

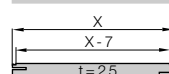

E2 E-Tubes Type R  
Inner height: 45 mm

Phone +49- (0) 22 03-96 49-800  
Fax +49- (0) 22 03-96 49-222





**Option KMA\* - pivoting**

- Recommended for unsupported and gliding applications
- Option - KMA with Quickflange
- Short and long travels
- Universal mountable with attachment capability on all sides

\*KMA = Polymer Metal Mounting Bracket

Moving end (outer link)  
680...1

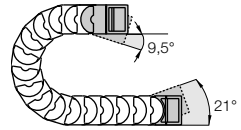

680...2

Fixed end (inner link)

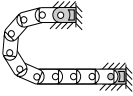

The attachment variants arising automatically by the choice of the KMA mounting bracket

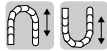

**Option KMA - locking**

- Recommended for vertical hanging / standing applications
- Option - KMA with Quickflange
- At very high speed and acceleration
- Universal mountable with attachment capability on all sides
- Flush mounting at both ends of the E-Tube

Moving end (outer link)  
680...3

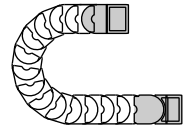

680...4

Fixed end (inner link)

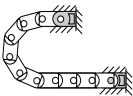

The attachment variants arising automatically by the choice of the KMA mounting bracket

**Dimensions and order configurations**



Quickflange upon request

**Part No. structure (pivoting)**

680.100.12.A



A... must be indicated on preassembled configurations  
Full set pivoting = 12  
Width  
KMA for selected chain type

Full set, for both ends:

680.100.12

Single-part order:

680.100.1

Mounting bracket with bore

680.100.2

Mounting bracket with pin

Part No. structure (locking)

680.100.34.A

A... must be indicated on preassembled configurations  
Full set locking = 34  
Width  
KMA for selected chain type

Full set, for both ends:

680.100.34

Single-part order:

680.100.3

Mounting bracket with bore

680.100.4

Mounting bracket with pin

**Quickflange**

Part No. 16800.QF, unassembled

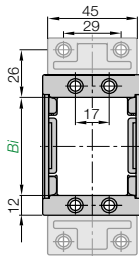

**680...1 Standard! (pivoting)**

680...3 (locking)

Moving end

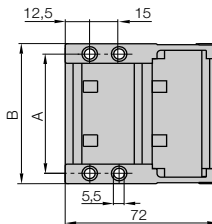

**Standard! (pivoting) 680...2**

(locking) 680...4

Fixed end

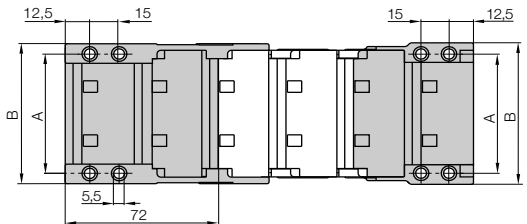

For Series	Part No. Full set	Part No. Full set with Quickflange	Dim. A [mm]	Dim. B [mm]
68.050.	680.050.	680.050. QF	62	74
68.075.	680.075.	680.075. QF	87	99
68.100.	680.100.	680.100. QF	112	124
68.115.	680.115.	680.115. QF	127	139
68.125.	680.125.	680.125. QF	137	149
68.150.	680.150.	680.150. QF	162	174
68.175.	680.175.	680.175. QF	187	199
68.200.	680.200.	680.200. QF	212	224
68.225.	680.225.	680.225. QF	237	249
68.250.	680.250.	680.250. QF	262	274

Please add the Part No. with the requested index - 12 for the pivoting configuration

e.g. 680.100.12 or 34 for the locking configuration e.g. 680.100.34

For the preassembled mode please add the index A e.g. 680.100.34 A

Quickflange unassembled: Part No. 16800.QF

The following parts are required for attachment of the mounting brackets:

- Socket head cap bolt M5 DIN 912-B.8 Length depends on the thickness of the attachment base
- Washer 5,3 DIN 125-ST ● Hexagon nut M5 DIN 934-8



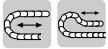

**Flange mounting brackets made of steel**

- Metallic flange brackets with popular hole patterns, easily be replaced by their modern successors, without having to alter the hole pattern
- Bolted connection outside of chain cross-section possible
- Universal mountable with attachment capability on all sides
- Steel, galvanized
- One-piece mounting bracket
- High stability

**Moving end (outer link)**  
906.462.X.1 (X = Bi)

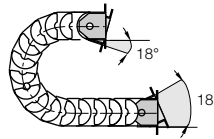

906.462.X.2 (X = Bi)  
**Fixed end (inner link)**



Flush mounting possibilities at both ends of the E-Tube

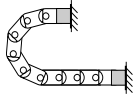

906.462.X.1 (X = Bi)

**Moving end**

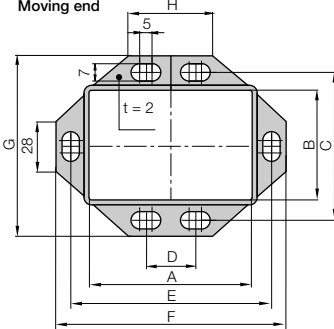

Hole pattern metallic flange  
Moving end 906.462.X.1

906.462.X.2 (X = Bi)

**Fixed end**

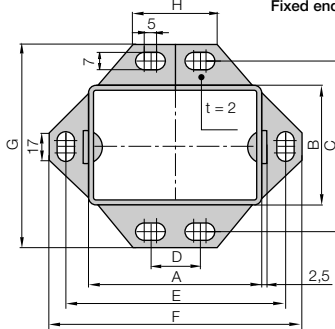

Hole pattern metallic flange  
Fixed end 906.462.X.2

**Dimensions and order configurations**

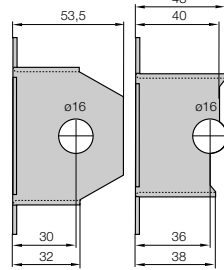

Moving end  
906.462.X.1

Fixed end  
906.462.X.2

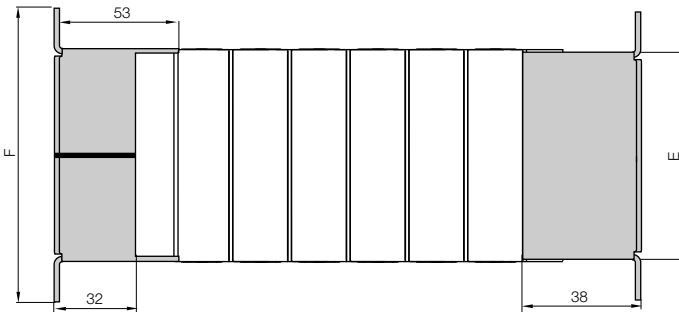

Full set, for both ends:

906.462. | Bi. | 12.

Single-part order:

906.462. | Bi. | 1

Mounting bracket with bore

906.462. | Bi. | 2.

Mounting bracket with pin

For Series	Hole pattern	Part No. Moving end	Part No. Fixed end	Bi (X) [mm]	Ba [mm]	Dim. A [mm]	Dim. B [mm]	Dim. C [mm]	Dim. D [mm]	Dim. E [mm]	Dim. F [mm]	Dim. G [mm]	Dim. H [mm]
R68.075	▶ 68.1	906.462.1.1	906.462.1.2	75	93	83,4	59	80	30	104	116	95	38
R68.115	▶ 68.2	906.462.2.1	906.462.2.2	115	133	123,4	59	80	50	144	156	95	78
R68.175	▶ 68.3	906.462.3.1	906.462.3.2	175	193	183,4	59	80	100	204	216	95	138

Phone +49- (0) 22 03-96 49-800  
Fax +49- (0) 22 03-96 49-222





### Integrated strain relief for E2 E-Tubes - Series R

**Characteristic features:** ● Strain relief disappears completely in the E-Tube ● Easy to assemble without any screws ● **Use:** Individual part for the manufacturing of switchgear cabinets or for the assembly of machines ● Accessory for igus® E-ChainSystems®

Part. No.	Width [mm]	Number of teeth	For Series
3050.Z	50	5	R68
3075.Z	75	7	R68

### Number of tiewrap plates 3050.Z for selected inner width $B_i$

$B_i$ [mm]	Width tiewrap plate [mm]	Number of tiewrap plate $n$
50	50	–
75	50	–
100	50	1
115	50	1
125	50	1
150	50	2
175	50	2
200	50	3
225	50	3
250	50	4

### Number of tiewrap plates 3075.Z for selected inner width $B_i$

$B_i$ [mm]	Width tiewrap plate [mm]	Number of tiewrap plate $n$
50	75	–
75	75	–
100	75	–
115	75	1
125	75	1
150	75	1
175	75	2
200	75	2
225	75	3
250	75	3



Other strain relief elements  
 ► chapter 10

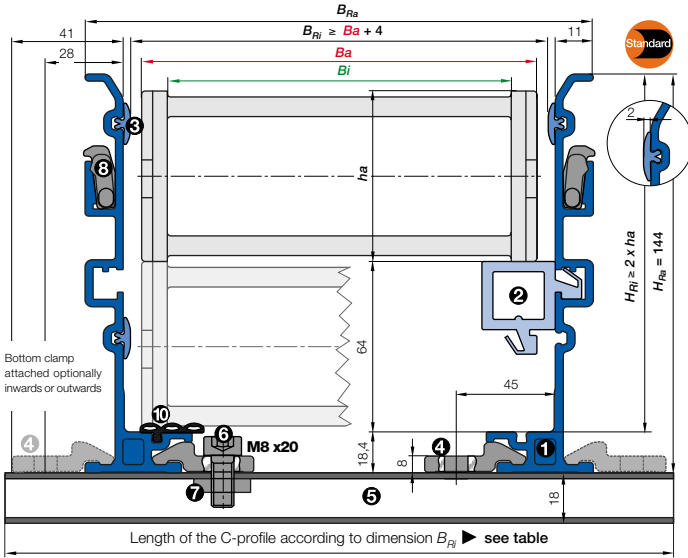

**B<sub>a</sub>** = Outer width E-Chains® / E-Tube  
**B<sub>i</sub>** = Inner width E-Chains® / E-Tube  
**h<sub>a</sub>** = Outer height E-Chains® / E-Tube  
**H<sub>Ri</sub>** = Inner trough height  
**H<sub>Ra</sub>** = Outer trough height  
**B<sub>Ri</sub>** = Inner trough width ► depends on dim. B<sub>a</sub>  
**B<sub>Ra</sub>** = Outer trough width  
**n<sub>Mon</sub>** = Number of installation sets (left/right)  
**n<sub>Ri</sub>** = Number of trough sets (left/right)  
 $H_{Ri} \geq 2 \cdot h_a$   
 $B_{Ri} \geq B_a + 4$

● = Guide trough set    ● = Glide bar  
 ● = Installation set "Basic"    ● = C-profile

**Installation set "Basic" with C-profile**

Bottom Clamp attached optionally inwards or outwards

68.100.200.0 ► Order example

B <sub>Ri</sub> [mm]	Part No.	
	attached inwards	attached outwards
.050	72	960.40.200
.075	97	960.40.225
.100	122	960.40.175
.115	137	960.40.200
.125	147	960.40.200
.150	172	960.40.225
.175	197	960.40.250
.200	222	960.40.275
.225	247	960.40.300
.250	272	960.40.325



- **Components, trough "Basic":** ① Trough side parts, aluminum, 2 m ② Glide bar, plastic, 2 m ③ Glide strips, plastic, 2 m (without glide strips on request) ⑩ Optional: Silencer profile, rubber
- **Components, installation set "Basic":** ④ Bottom clamp, aluminum ⑤ C-profile, steel galvanized ⑥ Screw M6 x16 ⑦ Sliding nut M6 ⑧ Interface connector, plastic

**Order example: Length of travel 30 m - Center mounted for Series 68.100.200.0 with B<sub>Ri</sub> = 122**

- Guide trough set (set of 2 trough side parts, incl. glide strips) **without** glide bar  
**Order text: 16 m guide trough without glide bar (8 x 2 m sections) Part No. 973.30.SL**
- Guide trough set (set of 2 trough side parts, incl. glide strips) **with** glide bar  
**Order text: 16 m guide trough with glide bar (8 x 2 m sections) Part No. 973.31.SL**
- Installation set "Basic" complete (guide trough-sets + 1)  
**Order text: 17 installation sets "Basic" Part No. 960.40.175**
- Option:** For an additional noise dampening with silencer profile, please add Index A - Example:  
**Part No. 973.30.SLA**

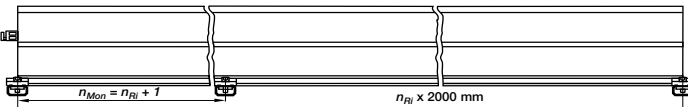

Principle sketch: Number of installation sets to be installed = **Number of trough sections + 1**

**Other guide trough systems**



"Heavy Duty" for the fastidiously construction with glide bar and silencer profiles  
 ► chapter 9

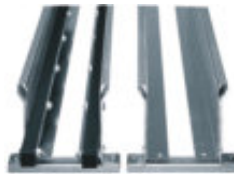

"Steel trough" very stable and robust guide trough out of steel, 2 pieces, adjustable on chain width  
 ► chapter 9



► chapter 10



► chapter 9



► page 6.5







E4



### Standard System E4/00

- Your first choice in E4 -
- The standard broad application spectrum
- Low noise - Noise reduction with TÜV certificate (Series E4/101)
- Versatile applications
- For short and long travels
- Numerous interior separation possibilities
- Can be opened from two sides - reduce assembly time
- E-Tube for chip protection
- Maximum robustness and life
- Wide smooth interior surface - cable and hose friendly
- Excellent in all environments

E4/00 ► from page 7.6



### E4/4 - with "tongue and groove" - high stability even when side-mounted

- Special: side-mounted and travels over 450 m
- Side-mounted - unsupported
- Best for "ESD" versions
- High torsional rigidity
- Also available as RoI E-Chain®
- Strong in rough operation
- Can be opened from two sides - reduce assembly time
- E-Tube for chip protection
- Maximum robustness and life
- Wide smooth interior surface - cable and hose friendly
- Excellent in all environments

E4/4 ► from page 7.86

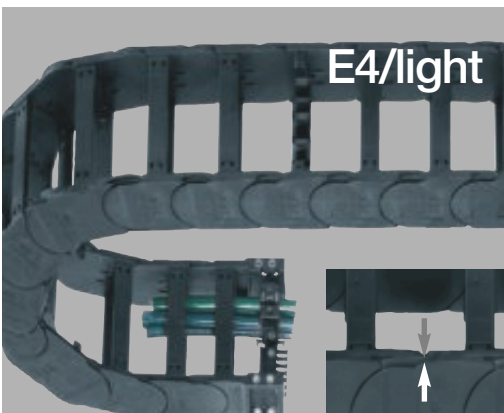

### E4/light - lighter sidelinks, low weight, cost-effective

- Special: Low weight, low cost
- Outer link with rear catch - high stability "side-mounted"
- Price saving with "light" design
- Optimized ratio of interior and exterior dimension
- Low weight
- Short travel with lighter loads
- Can be opened from two sides - reduce assembly time
- E-Tube for chip protection
- Maximum robustness and life
- Wide smooth interior surface - cable and hose friendly
- Excellent in all environments

E4/light ► from page 7.156

Whatever E-Chain® application you have, you can probably do it with the elements of the E4 modular family! Just let us know what you need, and we will build it for you within 24-72 hours. Choose your E4 system: E4/00 - the most versatile of the E4 E-ChainSystems® is a safe choice for most applications. By the "inner link - outer link" principle, the installation and dismantling are simple. Design features like the "brakes" in the chain stop dog clearly reduce the operation noise level. E4/4 - for extremely long travels and for unsupported, side-mounted application. The "tongue and groove" between two chain links enables this feature. Compression forces and stability are enhanced, and resistance against dirt and debris is increased. Special roller chain links make E4/4 real specialists for

long travels. The tongue and groove design similarly enables outstanding ESD/ATEX performance. The chain links are tightly linked to each other, so that electricity can flow through them when in contact with each other (Please note: This is valid only for the special conductive material igumid ESD and is not applicable for the standard reduced thickness of the side link (for all types) and a thinner crossbar (for some types: 14240, 14340, and 1640). Lower weight, larger inner space and lower price. E4/light E-Chain® attains solutions with an optimum price/performance ratio for many industrial applications. Especially good for short travels, hanging and small, standing designs. E4/light types are often the first choice.

## System E4 - Comparison of the main characteristics

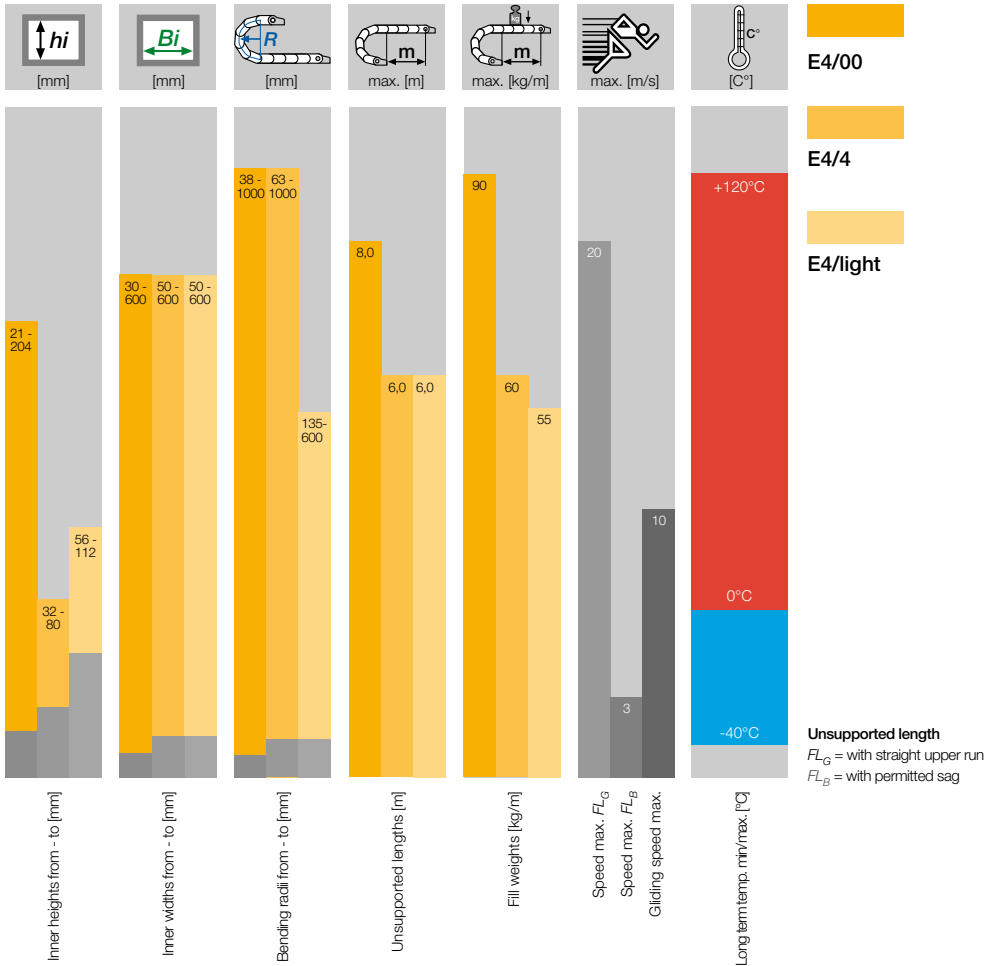



**Interior separations - various possibilities**



Vertical separators



Vertical separators, slotted

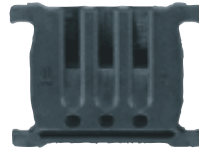

Side plates



Locking shelves



**Mounting brackets - various possibilities**



KMA with attachment capability on all sides

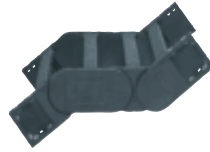

Mounting bracket KMA polymer pivoting with or without C-profile



Mounting bracket KMA polymer locking with or without C-profile



Mounting bracket made of steel



**Strain relief elements ▶ from chapter 10**

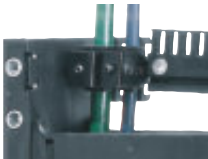

Integration with igus® KMA mounting brackets possible



Improved housing foot clamp for easy fit into C-profile

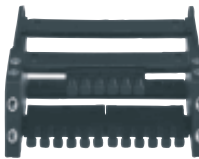

Clip-on tiwrap plates for snap-open crossbars



Tiwrap plates can be clipped directly into the C-profile



**Guide troughs - for long travels ▶ chapter 9**

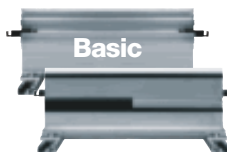

Aluminum "Super Trough"- modular trough system - Basic version and Heavy-Duty-version with add-on items

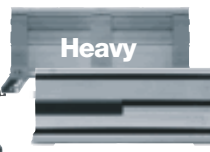

Steel guide troughs - very rugged, large selection



Aluminum guide troughs - simple assembly, light weight



**Additional features ▶ use product link on each page for details**

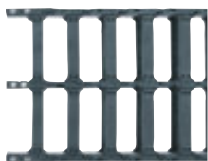

Widths up to 3000 mm due to extension links

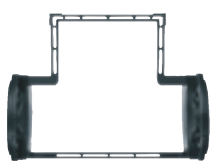

Extender crossbars for various E4 E-Chains® available



Hinged crossbars - 4 options available



SnapClip for E4 E-Chains® for attaching an additional conduit

**1 Rol E-Chain®** - Major reduction in drive power  
▶ **chapter 9**

**2 AUTO-GLIDE** for long travels without guide troughs  
▶ **chapter 9**

**3 E4/101** - optimal low-noise solution, with rubber pads, in the igus® System E4-program  
▶ **chapter 7**

**4 Extender Crossbar** - outer link suited for attaching an additional conduit ▶ **chapter 7**

**5 E4 ReadyChain®** - Plug-and-Play E-ChainSystems® - all inclusive  
▶ **page 1.41**

**Selecting a System E4 E-Chain®**

Application Profile	E4/00	E4/4	E4/light
<b>Application</b>			
High tensile forces	++	+	o
High shearing forces	++	++	o
Unsupported length, straight	++	++	++
Unsupported length, with sag	++	+	+
Unsupported, side-mounted	+	++	+
Gliding, side-mounted	++	++	+
High speeds	++	++	++
High accelerations	++	++	++
Ratio of inner dimension to outer dimension (space required)	+	+	++
Low fill weight required	+	+	++
Zig-zag applications	-	+	-
<b>Environment</b>			
Rolling noise generation	++	+	+
Gliding noise generation	++	++	+
High, constant humidity and temperature	+	++	-
Dirt resistance	++	++	+
Chip protection	++	++	+
Insensitivity to vibration and shock	++	++	-
Closed exterior and stop dogs	++	++	++
<b>Service life</b>			
Unsupported, straight	++	++	++
Unsupported, with sag	++	+	+
Gliding	++	++	+
<b>Installation</b>			
Opening/closing	++	++	++
Separating / joining	++	o	+

++ very well-suited      + well-suited      o conditionally suitable      - not suitable

- E4/00** ▶ Series 220, 280, 380, 400, 600, 640, 840, 800 and modified options
- E4/4** ▶ Series 2828, 3838, 4040, 5050 and modified options
- E4/light** ▶ Series 14040, 14240, 15050, 1640 and modified options







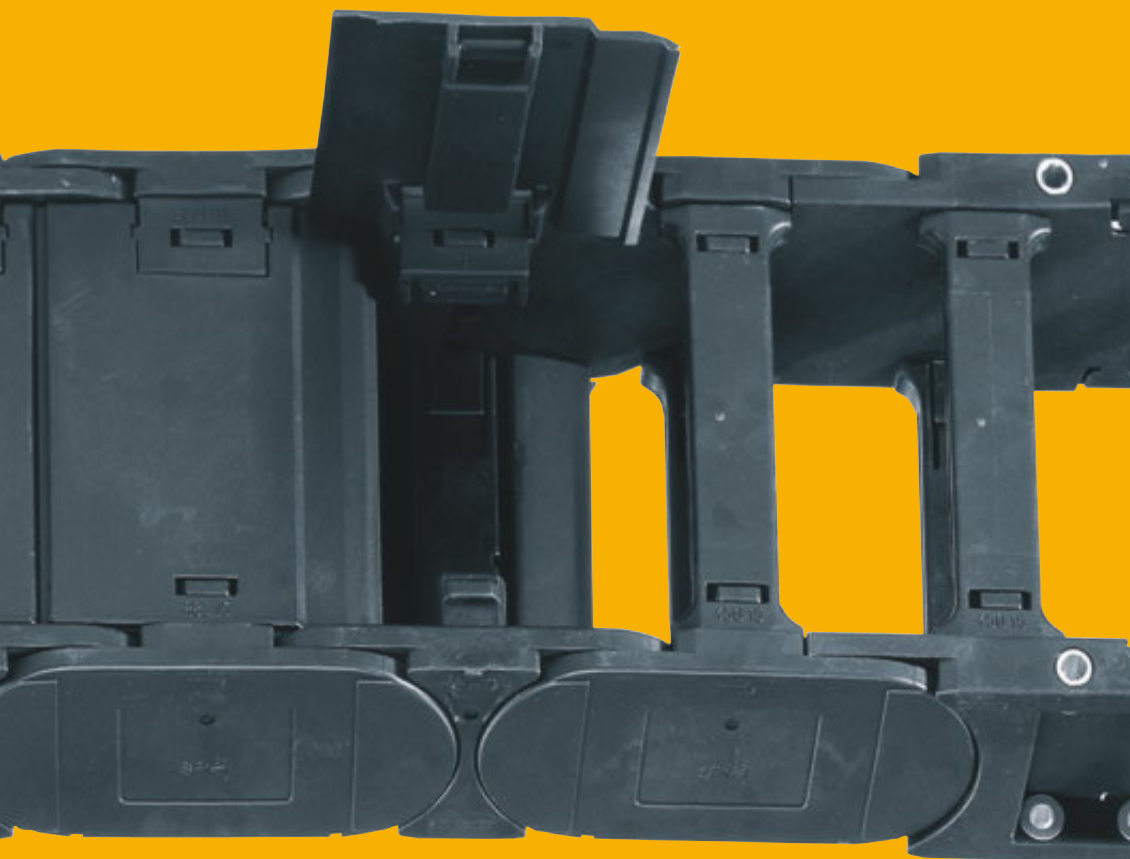

# E4/00

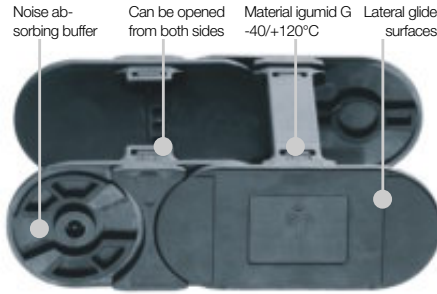

**E4/00: E-Chains® with a 4-piece design link**

- Lowest noise in its class
- Further noise reduction with rubber pads (Series E4/101)
- Broad application spectrum
- Numerous interior separation possibilities
- Broad system of modular accessories
- Widths up to 2000 mm using extension links
- Maximum stability in the igus® range
- Can be opened along both radii
- Max. travel: 200 - 400 m
- You can find more technical data about the material, chemical resistance, temperatures ► **Design, from page 1.38**

**Opening-principle**

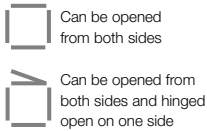

**Dimensioning**

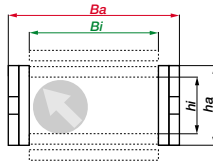

**Bending radius**

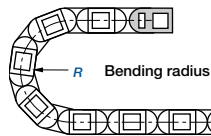

**Part No. structure**

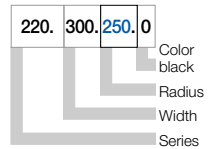

**Selection table**

Series	Inner height <i>hi</i> [mm]	Inner width <i>Bi</i> [mm]	Outer width <i>Ba</i> [mm]	Outer height <i>ha</i> [mm]	Bending radius <i>R</i> [mm]	Unsupported length max. [m]	page
<b>Crossbars every link, for particularly demanding applications</b>							
210	21	30 - 120	44 - 134	28	38 - 200	2,60	7.12
220	28	40 - 300	60 - 320	42	55 - 250	2,75	7.18
280	32	50 - 400	73 - 423	54	63 - 300	3,50	7.26
380	42	50 - 400	76 - 426	64	75 - 350	3,80	7.36
400	56	50 - 600	84 - 634	84	135 - 500	4,50	7.46
600	108	200 - 600	252 - 652	140	200 - 1000	7,00	7.56
640	112	87 - 562	139 - 614	140	200 - 1000	7,00	7.64
800	200	200 - 600	260 - 660	236	325 - 1000	8,00	7.74
840	204	100 - 563	160 - 623	236	325 - 1000	8,00	7.80

**Crossbars every other link, for almost all applications**

290	32	50 - 400	73 - 423	54	63 - 300	3,50	7.26
390	42	50 - 400	76 - 426	64	75 - 350	3,80	7.36
410	56	50 - 600	84 - 634	84	135 - 500	4,50	7.46
601	108	200 - 600	252 - 652	140	200 - 1000	7,00	7.56

**E-Tube - fully enclosed, excellent cable protection**

R760	28	50 - 300	70 - 320	42	63 - 250	2,75	7.18
R770	32	50 - 300	73 - 323	54	125 - 300	3,50	7.26
R780	42	50 - 300	76 - 326	64	125 - 350	3,80	7.36
R880	56	75 - 462	109 - 497	84	150 - 500	4,50	7.46
R608	108	200 - 400	252 - 452	140	250 - 1000	7,00	7.56

### Comparison of the main characteristics

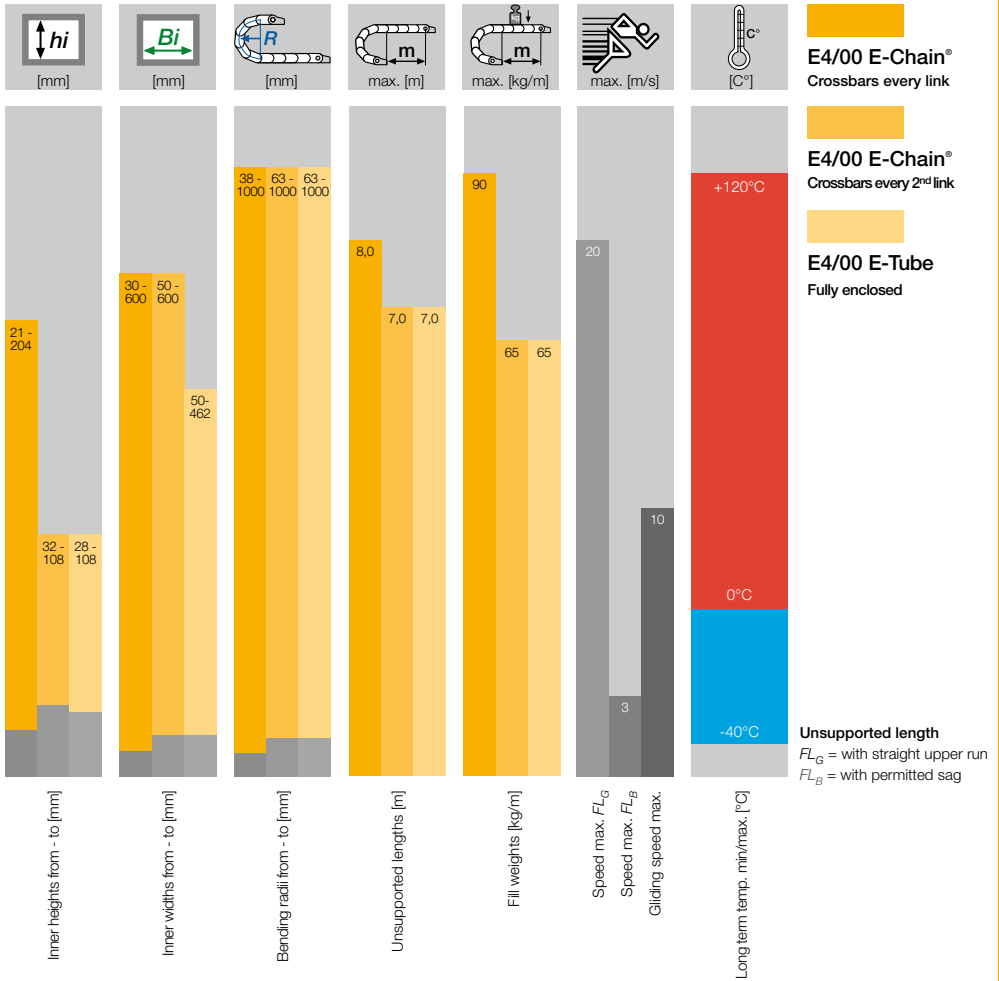

### Additional quality features - System E4/00

IPA Certificate, Cleanroom ISO Class 3 at  $v=1$  m/s and ISO Class 4 at  $v=2$  m/s for Series 280.10.100.0 tested with igus® Chainflex® cables

ESD/ATEX upon request

Low-noise due to special rubber pads design

System E4/00 proved for long travels

System E4 - 4-piece design link

**E4/00 (pronounced: E4-hundred) as the most versatile of the E4 chains is a safe choice in almost all applications** (Note: Choose E4/4 for travels > 150 m and for "on the side-unsupported"). Its "inner link - outer link" design makes it easy to assemble and disassemble on site. The "noise buffer" design feature reduces operating noises noticeably. Robustness pairs with elasticity, when external vibrations attack. As a **standard chain** with the broadest application spectrum, the version **E4/00** can be used almost everywhere without special knowledge of the respective application. **The E4/00 is available around the world from stock.**

### Typical industries & applications

- Robotics and handling ● Material handling ● Freezing environment ● Construction machinery ● Machine tools ● Woodworking machinery ● Machines of all kinds ● Semicon ● Cleanroom ● General machinery

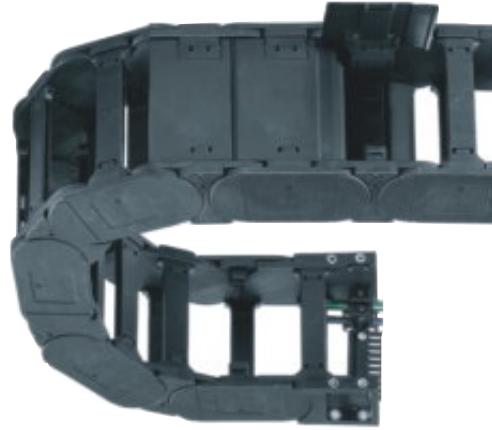

Robust, quiet, modular - E4/00 sets the benchmark



Quiet and strong - ideal for handling applications of all kinds



Robust engineering for construction equipment



Long unsupported spans, high stability

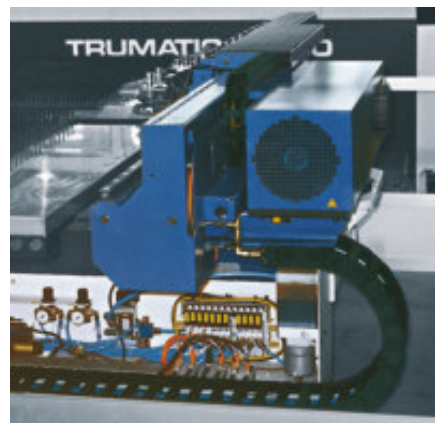

High accelerations, references with more than 50 Million cycles

System E4/00 | E-Chains® | **Opening**



1  
Remove crossbars - Insert screwdriver into the slot, push down, release by lever action



2  
Remove clips - Insert screwdriver into the slot and push down, release by lever action

System E4/00 | E-Tubes | **Opening**

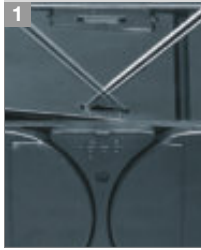

1  
Remove lids/bottoms - Insert screwdriver into the slot, release by lever action

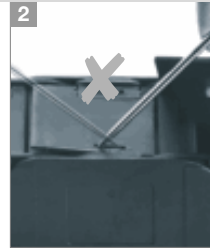

2  
Release **only one side** to swivel the lid

System E4/00 | E-Chains® and E-Tubes | **Assembling**



1  
Line up two inner side links, side by side. Attach an outer side link between



2  
Assemble crossbars - Push down and snap in by using a screwdriver



3  
Assemble clips (E-Chains® with crossbars every other link) - Push down and snap in



4  
Assemble E-Tube lids/bottoms - Attach to the connector at an angle - Snap in

System E4/00 | E-Chains® and E-Tubes | **Separating**



1  
Remove crossbars, clips, lids and bottoms at the outer links...



2  
...guide the screwdriver into the slot between side links and release it by levering ...



3  
...remove the outer links to the side...



4  
...and separate the E-Chain®



You can find an assembly video on the web ► [www.igus.de/en/video](http://www.igus.de/en/video)

●●● Price index

Low-noise

Cleanroom test upon request

ESD classification:  
Electrically conductive ESD/ATEX version upon request



Opening E-Chains\*: Remove crossbars and clips - Insert screwdriver into the slot, push down, release by lever action. Repeat action for the other side

When to use the Series 210:

- If a low-noise version is required
- At very high speeds and/or accelerations
- For long travels

When not to use it:

- If an extrem vibration-free E-Chain\* is necessary  
▶ Series E3.22, page 8.18
- When an E-Chain\* or E-Tube is required that snaps open only to one side, to realize cost savings  
▶ Series 1400/1450/1480/1500, page 5.84
- When E-Tubes that snap open to one side only are desired, at a lower cost  
▶ Series R117/R118, page 6.6

- 1 Crossbars are removable along both radii
- 2 Stop dog with "brake" for noise reduction
- 3 Wide, rounded plastic crossbars - cable friendly
- 4 Optimized glide pads
- 5 Interior separation with standard locking separator
- 6 Integrated strain relief possible
- 7 Mounting brackets pivoting on one side with all-round attachment option
- 8 Dirt-repellent exterior
- 9 E-Chains\* also available with reverse bending radius "RBR"
- 10 Tongue and groove for more stability
- 11 Strain relief separator - Separator with integrated strain relief for the use in the first or last chain link ▶ page 7.16

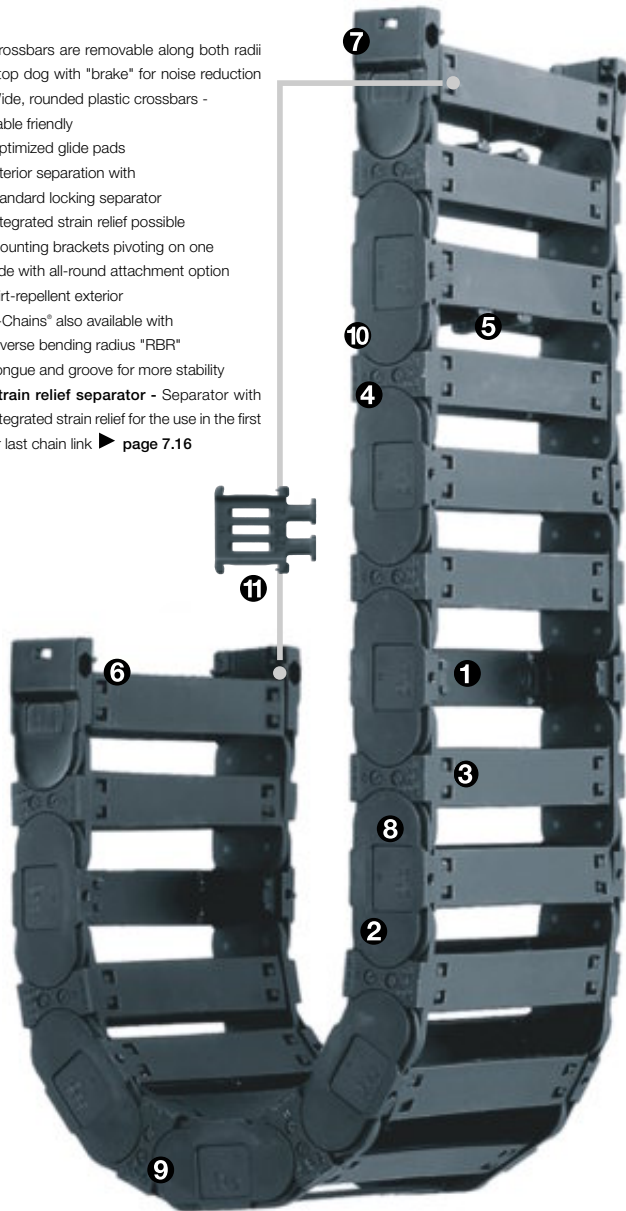

Order example complete E-Chain\*  
Please indicate chain-lengths or number of links Example: 2 m or 66 links

2 m 210.120.100.0	E-Chain*
with 2 separators T2112 assembled every 2nd link	Interior separation
1 set 21000.120.1.12	Mounting bracket

**Unsupported length**

$FL_G$  = with straight upper run

$FL_B$  = with permitted sag

Further information ► **Design, page 1.12**

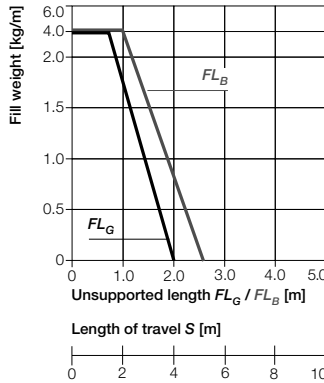
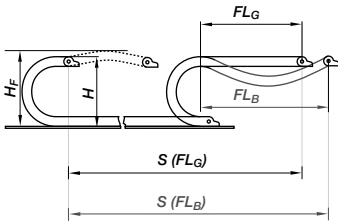

- $S$  = Length of travel
  - $R$  = Bending radius
  - $H$  = Nominal clearance height
  - $H_F$  = Required clearance height
  - $H_{in}$  = Trough inner height
  - $D$  = Overlength E-Chain® radius in final position
  - $K = \pi \cdot R + \text{"safety"}$
  - $D_2$  = Over length - long travels, gliding
  - $K_2$  = "Further add-on"
  - $H_2$  = "Mounting height"
- \*if the mounting bracket location is set lower

**Other installation methods**

- Vertical, hanging  $\leq 40$  m
- Vertical, standing  $\leq 3$  m
- Side mounted, un supp.  $\leq 1$  m
- Rotary requires further calculation
- Unsupported length of upper run = upon request

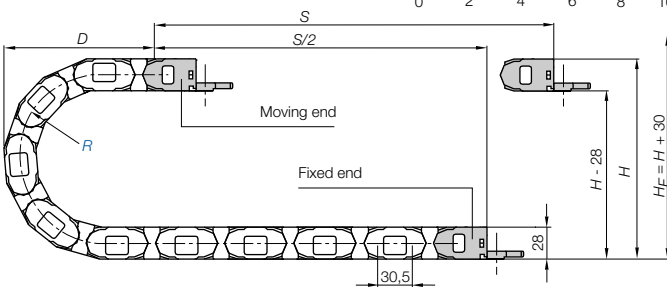

Pitch = 30,5 mm/link    Links/m = 33 (1007mm)    Chain length =  $S/2 + K$

R	038	048	063	075	100	150	200
H	104	124	154	178	228	328	428
D	085	095	110	120	145	195	245
K	185	215	260	300	380	535	690
$D_2^{+25}$	-	-	-	-	490	530	665
$K_2$	-	-	-	-	782	920	1104
$H_2$	-	-	-	-	135	135	135



**Short travels - unsupported**

Unsupported E-Chains® feature positive camber over short travels. This must be accounted for when specifying the clearance height  $H_F$ . Please consult igus® if space is particularly restricted.

The required clearance height:  
 $H_F = H + 30$  mm  
(with 1,5 kg/m fill weight)

**Long travel lengths from 10 m to max. 120 m    Chain length =  $S/2 + K_2$**

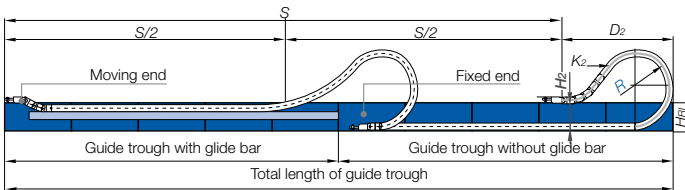

In case of travels between 4 and 10 m we recommend a longer unsupported length.



**Gliding, long travel applications (max. 120 m)**

In this case the E-Chain® upper run will be introduced in a guide trough on the lower run. We recommend to realize the engineering of such a plant by our technicians.

Speed / acceleration $FL_G$	max. 20 [m/s] / max. 200 [m/s <sup>2</sup> ]
Speed / acceleration $FL_B$	max. 3 [m/s] / max. 6 [m/s <sup>2</sup> ]
Gliding speed / acceleration (maximum)	max. 10 [m/s] / max. 50 [m/s <sup>2</sup> ]
Material - permitted temperature °C	igumid G / -40° up to +120° C
Flammability class, igumid G	VDE 0304 IIC UL94 HB

**Technical Data**



Details of material properties  
► page 1.38



System E4/00  
Inner height: 21 mm

Phone +49- (0) 22 03-96 49-800  
Fax +49- (0) 22 03-96 49-222



► page 7.11



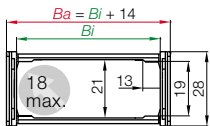

Part No. structure

210. 120. 100. 0



Series 210 - E-Chain® with crossbars every link

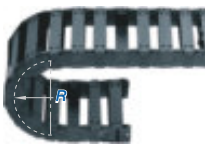

- Robust solution with crossbars every link
- Can be opened from two sides
- Removable crossbars



Part No.	<i>Bi</i> [mm]	<i>Ba</i> [mm]	Weight [kg/m]
210.030. <input type="text"/> .0	30	44	≈ 0,60
210.040. <input type="text"/> .0	40	54	≈ 0,64
210.050. <input type="text"/> .0	50	64	≈ 0,67
210.060. <input type="text"/> .0	60	74	≈ 0,71
210.070. <input type="text"/> .0	70	84	≈ 0,74
210.080. <input type="text"/> .0	80	94	≈ 0,78
210.100. <input type="text"/> .0	100	114	≈ 0,85
210.120. <input type="text"/> .0	120	134	≈ 0,92

The widths *Bi* 90 / 110 are available upon request. Time of delivery approx. 6-8 weeks after order.

Available bending radii

R [mm]  038  048  063  075  100  150  200

Supplement Part No. with required radius. Example: 210.120.  100 .0

0 = standard color, other colors ► page 1.39 · Pitch = 30,5 mm/link - Links/m = 33

Part No. E-Chain®  
links, single parts

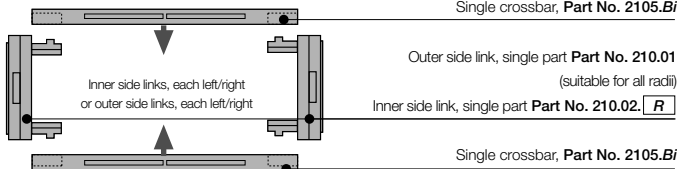
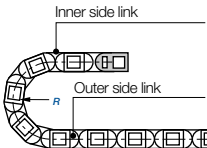

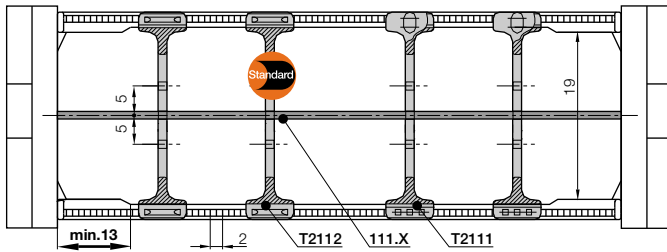

**Option 1**

- Vertical separators
- Full-width shelves

**Option 1: Vertical separators**

Vertical separators are used if a vertical subdivision of the E-Chain® interior is required - By standard vertical separators are assembled every other E-Chain® link. **Note:** Observe a lateral spacing of at least 13 mm!

● **Standard separator T2102 for E-Chains®** is used when vertical and horizontal separation is required. Due to its slot, it allows basic vertical/horizontal shelving arrangements.

● **Notch separator T2101 for E-Chains®** can be locked in 2 mm increments due to gaps on the crossbars. The separator cannot slide sideways during operation.

● **Strain relief separator T2103.Z** can be integrated into the mounting bracket and can be placed there at any point. It combines strain relief and interior separation.



<b>Vertical separator for E-Chains®</b>	
unassembled	T2102
assembled	T2112



<b>Notch separator for E-Chains®</b>	
unassembled	T2101
assembled	T2111



<b>Strain relief separator for E-Chains®</b>	
unassembled	T2103.Z
assembled	T2113.Z



Vertical separator T2102



Notch separator T2101



Strain relief separator T2103.Z



Full-width shelf 110.X

**Additionally:**

● **Full-width shelf 110.X** - this option makes sense in applications with many thin cables with similar diameters. It is based upon **vertical separator T2102** and **T2101**, with inserted full-width shelves.

Width X [mm]	Part No. unassembled	Part No. assembled	Width X [mm]	Part No. unassembled	Part No. assembled
30	110.30	111.30	80	110.80	111.80
40	110.40	111.40	90	110.90	111.90
50	110.50	111.50	100	110.100	111.100
60	110.60	111.60	110	110.110	111.110
70	110.70	111.70	120	110.120	111.120

Full-width shelf

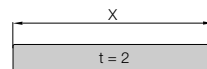

System E4/00  
Inner height: 21 mm

Phone +49- (0) 22 03-96 49-800  
Fax +49- (0) 22 03-96 49-222



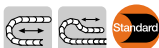

Moving end  
21000...1.1

**The Standard - option polymer, pivoting**

- Recommended for unsupported and gliding applications
- KMA mounting bracket with attachment capability on all sides
- Well suited for tight installation conditions
- Integrated strain relief possible
- Variable traverse angle for flexible assembly

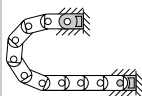
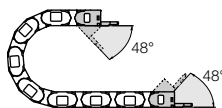

The attachment variants arising automatically by the choice of the KMA mounting bracket

Fixed end  
21000...1.2

**Dimensions and order configurations**

Moving end  
21000...1.1

Fixed end  
21000...1.2

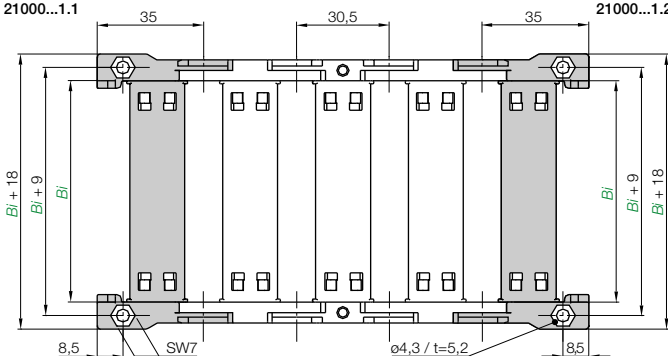

Part No. structure

21000.030.1.12



Full set, for both ends:

21000.030.1.12

Single-part order:

21000.030.1.1

Mounting bracket with bore

21000.030.1.2

Mounting bracket with pin

For	Part No.	Bi
E-Chain® full set		[mm]
.030. ▶	21000.030.1.12	30
.040. ▶	21000.040.1.12	40
.050. ▶	21000.050.1.12	50
.060. ▶	21000.060.1.12	60
.070. ▶	21000.070.1.12	70

For	Part No.	Bi
E-Chain® full set		[mm]
.080. ▶	21000.080.1.12	80
.090. ▶	21000.090.1.12	90
.100. ▶	21000.100.1.12	100
.110. ▶	21000.110.1.12	110
.120. ▶	21000.120.1.12	120

Phone +49- (0) 22 03-96 49-800  
Fax +49- (0) 22 03-96 49-222

igus® GmbH  
51147 Cologne

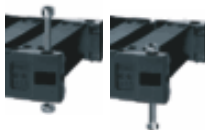

**Special feature mounting brackets KMA: Series 210**

- Mounting brackets with attachment points on all sides
- Special design of the counterbore as hexagon - the inlay of the nut (M4) and the counterboring of the hexagon socket head screw (M4), is consequently possible
- **Attention:** Mounting brackets always need to end with an inner plate (odd number of links)

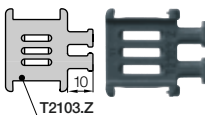

Other strain relief elements  
▶ chapter 10

System E4/00 | **Series 210** | **Accessories** | Strain Relief

**Strain relief separator**

Separator with integrated strain relief, for use in the first or last chain link. For manufacturing of switchgear cabinets or for the assembly of machines. Easy to assemble without any fastening device. Separator base T2103.Z is 8 mm wide. The possible number of separators per E-Chain® is defined by its inner width *Bi* and by the cable-diameter. **Details ▶ chapter 10**

Part No.	Number of teeth	For Series
T2103.Z	2 one side	210

Internet: [www.igus.de](http://www.igus.de)  
E-mail: [info@igus.de](mailto:info@igus.de)

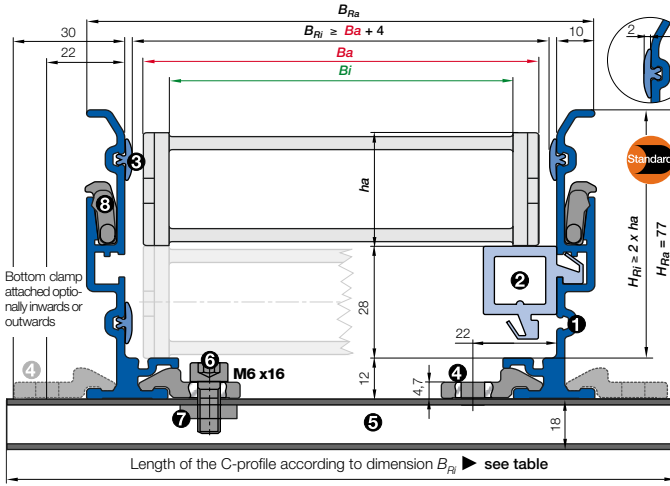

- $B_a$  = Outer width E-Chains\* / E-Tube
- $B_i$  = Inner width E-Chains\* / E-Tube
- $h_a$  = Outer height E-Chains\* / E-Tube
- $H_{Ri}$  = Inner trough height
- $H_{Ra}$  = Outer trough height
- $B_{Ri}$  = Inner trough width ► depends on dim.  $B_a$
- $B_{Ra}$  = Outer trough width
- $n_{Mon}$  = Number of installation sets (left/right)
- $n_{Ri}$  = Number of trough sets (left/right)
- $H_{Ri} \geq 2 \cdot h_a$
- $B_{Ri} \geq B_a + 4$
- = Guide trough set    ● = Glide bar
- = Installation set "Basic"    ● = C-profile

**Installation set "Basic" with C-profile**

Bottom Clamp attached optionally inwards or outwards

210.050.100.0 ► Order example

$B_{Ri}$ [mm]	Part No.	
	attached inwards	attached outwards
.030	48	960.30.150
.040	58	960.30.125
.050	68	960.30.125
.060	78	960.30.125
.070	88	960.30.150
.080	98	960.30.150
.090	108	960.30.175
.100	118	960.30.175
.110	128	960.30.175
.120	138	960.30.200



- **Components, trough "Basic":** ① Trough side parts, aluminum, 2 m ② Glide bar, plastic, 2 m ③ Glide strips, plastic, 2 m (without glide strips on request) ⑩ Optional: Silencer profile, rubber
- **Components, installation set "Basic":** ④ Bottom clamp, aluminum ⑤ C-profile, steel galvanized ⑥ Screw M6 x16 ⑦ Sliding nut M6 ⑧ Interface connector, plastic



**Order example: Length of travel 30 m - Center mounted for Series 210.050.100.0 with  $B_{Ri} = 68$**

- Guide trough set (set of 2 trough side parts, incl. glide strips) **without** glide bar  
 Order text: 16 m Guide trough without glide bar (8 x 2 m sections) **Part No. 970.30.SL**
- Guide trough set (set of 2 trough side parts, incl. glide strips) **with** glide bar  
 Order text: 16 m Guide trough with glide bar (8 x 2 m sections) **Part No. 970.32.SL**
- Installation set "Basic" complete (Guide trough-sets + 1)  
 Order text: 17 Installation sets "Basic" **Part No. 960.30.125**

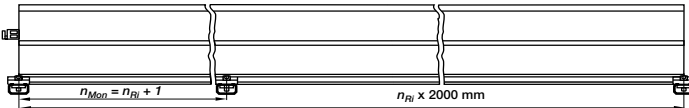

Principle sketch: Number of installation sets to be installed = **Number of trough sections + 1**

**Other guide trough systems**

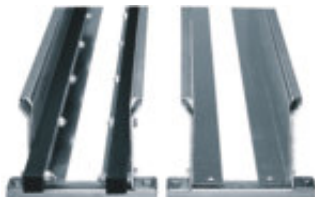

"Steel trough" very stable and robust guide trough out of steel, 2 pieces, adjustable on chain width



► chapter 10



► chapter 9



► page 7.11

Price index



Low noise version E4/101  
Series 221 available with  
special rubber pads design



Cleanroom test  
upon request



ESD classification:  
Electrically conductive ESD/ATEX  
version upon request



Opening E-Chains®: Remove crossbars and  
clips - Insert screwdriver into the slot, push  
down, release by lever action



Remove lids/bottoms (E-Tubes) - Insert screw-  
driver into the slot, release by lever action



When to use the Series 220/R760:

- If a low-noise version is required
- At very high speeds and/or accelerations
- For long travels
- For high additional loads



When not to use it:

- Zig-zag lift applications
  - ▶ System E4/4, from page 7.86
- For side-mounted applications
  - ▶ System E4/4, from page 7.86
- If an extrem vibration-free E-Chain® is necessary
  - ▶ Series E6.29/R6.29, page 8.40/8.46

- 1 Crossbars are removable along both radii
- 2 Wide, rounded plastic crossbars - cable friendly
- 3 Stop dog with "brake" for noise reduction
- 4 Closed and open styles can be combined
- 5 Hinged snap-open removable lids along outer radius of E-Tube
- 6 Optimized glide pads
- 7 Numerous interior separation possibilities
- 8 KMA mounting brackets with attachment points on all sides
- 9 Locking or pivoting mounting brackets available
- 10 Integrated strain relief possible
- 11 E-Chains® also available with reverse bending radius "RBR"



Also available as  
E4/00-NC without  
camber: 220-NC



Order example complete E-Chain®

Please indicate chain-lengths or number of links Example: 3 m or 66 links

3 m 220.300.250.0

E-Chain®

with 2 separators 2211 assembled every 2<sup>nd</sup> link

Interior separation

1 set 2200.300.1.12

Mounting bracket

### Unsupported length

$FL_G$  = with straight upper run  
 $FL_B$  = with permitted sag  
 Further information ► Design, page 1.12

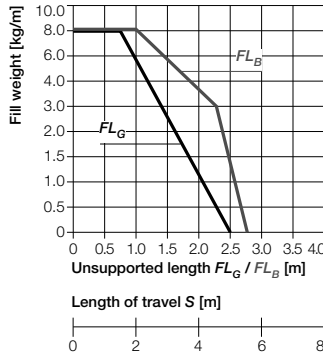
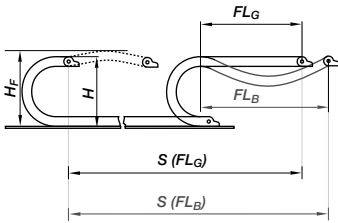

- $S$  = Length of travel
  - $R$  = Bending radius
  - $H$  = Nominal clearance height
  - $H_F$  = Required clearance height
  - $H_{in}$  = Trough inner height
  - $D$  = Overlength E-Chain® radius in final position
  - $K = \pi \cdot R + \text{"safety"}$
  - $D_2$  = Overlength - long travels, gliding
  - $K_2$  = "Further add-on"
  - $H_2$  = "Mounting height"
- \*if the mounting bracket location is set lower

#### Other installation methods

- Vertical, hanging  $\leq 80$  m
- Vertical, standing  $\leq 5$  m
- Side mounted, un supp.  $\leq 2$  m
- Rotary requires further calculation
- Unsupported length of upper run = upon request



### Short travels - unsupported

Unsupported E-Chains® feature positive camber over short travels. This must be accounted for when specifying the clearance height  $H_F$ . Please consult igus® if space is particularly restricted.

The required clearance height:  
 $H_F = H + 40$  mm  
 (with 1,0 kg/m fill weight)

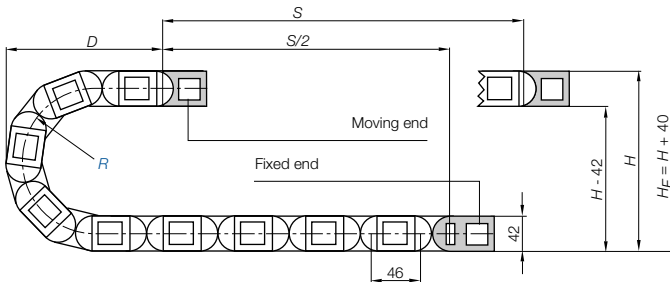

Pitch = 46 mm/link      Links/m = 22 (1012 mm)      Chain length =  $S/2 + K$

R	055	063	075	100	125	150	175	200	250
H	154	170	194	244	294	344	394	444	544
D	125	133	145	170	195	220	245	270	320
K	265	290	330	410	485	565	645	725	880
$D_2^{+25}$	-	-	-	350	490	530	665	730	935
$K_2$	-	-	-	598	782	920	1104	1242	1610
$H_2$	-	-	-	158	158	158	158	158	158

### Long travel lengths from 10 m to max. 200 m      Chain length = $S/2 + K_2$

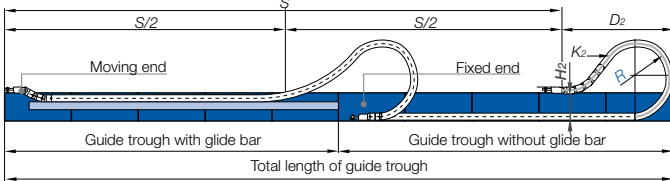

In case of travels between 4 and 10 m we recommend a longer unsupported length.



### Gliding, long travel applications (max. 200 m)

In this case the E-Chain® upper run will be introduced in a guide trough on the lower run. We recommend to realize the engineering of such a plant by our technicians.

Speed / acceleration $FL_G$	max. 20 [m/s] / max. 200 [m/s <sup>2</sup> ]
Speed / acceleration $FL_B$	max. 3 [m/s] / max. 6 [m/s <sup>2</sup> ]
Gliding speed / acceleration (maximum)	max. 10 [m/s] / max. 50 [m/s <sup>2</sup> ]
Material - permitted temperature °C	igumid G / -40° up to +120° C
Flammability class, igumid G	VDE 0304 IIC UL94 HB

### Technical Data



Details of material properties  
 ► page 1.38

28

System E4/00  
 Inner height: 28 mm

Phone +49- (0) 22 03-96 49-800  
 Fax +49- (0) 22 03-96 49-222



► page 7.11

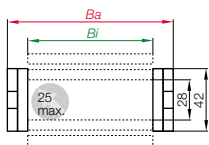

Part No. structure

220. 300. 250. 0



Color  
black  
Bending  
radius  
Width  
Series



Series 220 - E-Chain® with crossbars every link

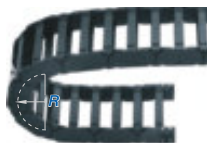

- Robust solution with crossbars every link
- Can be opened from two sides
- Removable crossbars

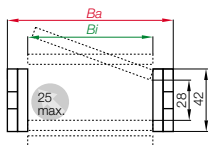

Part No. structure

760. 300. 250. 0



Color  
black  
Bending  
radius  
Width  
Series

Series R760 - Fully enclosed E-Tube



- Fully enclosed
- Excellent cable protection against dirt
- Protection against hot chips (up to 900°C)
- Lids along the entire inner radius are completely removable. Lids along the entire outer radius are single sided snap-open with a hinge on the other side to keep them attached to the chain or completely removable.



Unsupported application  
(with harnesses)  
E-Chain® Series E4/00





Part No.	<i>Bi</i>	<i>Ba</i>	220	R760
	[mm]	[mm]	[kg/m]	[kg/m]
220.040..... □.0	40	60	≈ 1,06	-
220/760.050. □.0	50	70	≈ 1,10	≈ 2,20
220.062..... □.0	62	82	≈ 1,14	-
220.070..... □.0	70	90	≈ 1,18	-
220/760.075. □.0	75	95	≈ 1,21	≈ 2,30
220.087..... □.0	87	107	≈ 1,27	-
220/760.100. □.0	100	120	≈ 1,32	≈ 2,54
220/760.125. □.0	125	145	≈ 1,43	≈ 2,78
220/760.150. □.0	150	170	≈ 1,54	≈ 3,02
220/760.175. □.0	175	195	≈ 1,65	≈ 3,26
220/760.200. □.0	200	220	≈ 1,76	≈ 3,50
220/760.225. □.0	225	245	≈ 1,87	≈ 3,74
220/760.250. □.0	250	270	≈ 1,98	≈ 3,98
220.275..... □.0	275	295	≈ 2,09	-
220/760.300. □.0	300	320	≈ 2,20	≈ 4,46

Available bending radii

R [mm] 055\* 063 075 100 125 150 175 200 250

Supplement Part No. with required radius. Example: 220.300. 250.0

0 = standard color, other colors ► page 1.39 · Pitch = 46 mm/link - Links/m = 22

\*not available for R760

TIP!

### Hot Chips up to 850°C

E-Tubes that repel hot chips, up to 850 °C

Some applications, depending on amount and size of the chips, can burn or melt the surface. That is no longer the case with the new igus® "Igmuid HT" material.

Further information: [www.igus.de/en/HT](http://www.igus.de/en/HT) or phone: +49-0 22 03-96 49-800



System E4/00  
Inner height: 28 mm

Phone +49- (0) 22 03-96 49-800  
Fax +49- (0) 22 03-96 49-222



► page 7.11

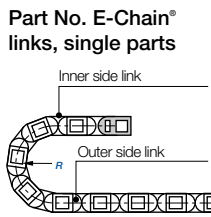
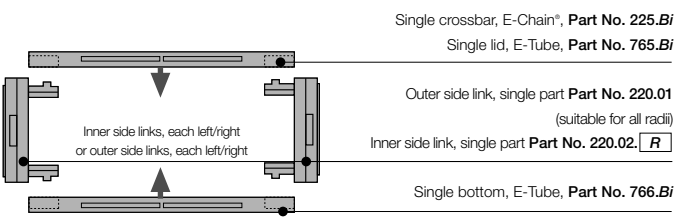

### Low-noise! Special low-noise version with rubber pads

Series 221 - Order example 221.100.250.0

Further information: [www.igus.de](http://www.igus.de) or phone +49-0 22 03-96 49-800

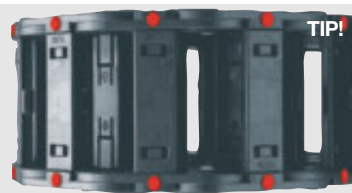



- Option 1**
- Vertical separators
  - Spacers
  - Side plate
  - Full-width shelves

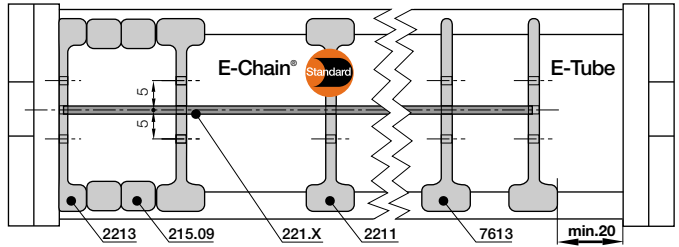

Vertical separator  
2201



Vertical separator  
7603



Spacer  
205.09



Side plate  
2203



Full-width shelf 220.X

Vertical separator for E-Chains®	
unassembled	2201
assembled	2211

Vertical separator for E-Tubes	
unassembled	7603
assembled	7613

Spacer* for E-Chains®	
unassembled	205.09
assembled	215.09

Side plate for E-Chains®	
unassembled	2203
assembled	2213

\*For side-mounted applications

### Option 1: Vertical separators and spacers

Vertical separators are used if a vertical subdivision of the E-Chain® interior is required - By standard vertical separators are assembled every other E-Chain® link. **Note:** Observe a lateral spacing of at least 20 mm for E-Tubes!

- **Standard separator 2201 for E-Chains®** is used when vertical and horizontal separation is required. Due to its slot, it allows basic vertical/horizontal shelving arrangements.

- **Vertical separator 7603 for E-Tubes R760.**

- Vertical separators in side-mounted applications, for instance, can be fixed in position by means of **spacer 205.09 for E-Chains®**. A wide range of intervals between the vertical separators is adjustable here.

- **Note on spacers:** The available interior height is reduced by 2 mm per spacer (4 mm when spacers are fitted on both sides). To avoid this, the parts can also be installed from the outside on the opening crossbar.

### Additionally:

- **Side plate 2203 and full-width shelf 220.X** - this option makes sense in applications with many thin cables with similar diameters. It is based upon **vertical separator 2201 (7603)** for the **Series R760 E-Tube** is put in place and the shelf is inserted into the separator's slots. If no separators are desired, **side plate 2203** must be used with the **Series 220 E-Chain®**. This solution is not available for E-Tubes.

Full-width shelf

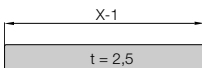

Width X [mm]	Part No. unassembled	Part No. assembled	Width X [mm]	Part No. unassembled	Part No. assembled
40	220.40	221.40	87	220.87	221.87
50	220.50	221.50	100	220.100	221.100
60	220.60	221.60	125	220.125	221.125
62	220.62	221.62	150	220.150	221.150
70	220.70	221.70	175	220.175	221.175
75	220.75	221.75	200	220.200	221.200

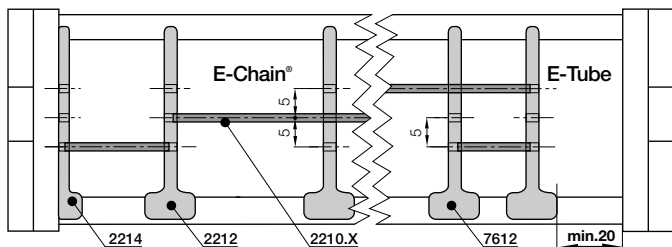

**Option 2**

- Side plates
- Middle plates

**Option 2: Shelves**

For applications involving many cables with different diameters. The shelves can be arranged elevator-shifted with different bottoms.

● Side plates 2204, middle plates 2202 and shelves 2200.X form the basic pattern of a shelf system. Shelves of various widths can be arranged at 3 different heights (in 5 mm increments).

● A middle plate 7602 is available for the E-Tube. Side plates are not available for the E-Tube.



Side plate for E-Chains®	
unassembled	2204
assembled	2214



Middle plate for E-Chains®	
unassembled	2202
assembled	2212



Middle plate for E-Tubes	
unassembled	7602
assembled	7612

Width X [mm]	Part No. unassembled	Part No. assembled
18	2200.18	2210.18
23	2200.23	2210.23
28	2200.28	2210.28
33	2200.33	2210.33
38	2200.38	2210.38
43	2200.43	2210.43
48	2200.48	2210.48

Width X [mm]	Part No. unassembled	Part No. assembled
58	2200.58	2210.58
68	2200.68	2210.68
73	2200.73	2210.73
88	2200.88	2210.88
99	2200.99	2210.99
124	2200.124	2210.124
149	2200.149	2210.149



Side plate 2204



Middle plate 2202



Middle plate 7602



Shelf 2200.X

Shelf

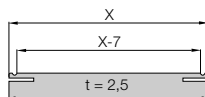

Machine tool gantry with various E4/00 E-Chains® - fast movements and high cycle counts

System E4/00  
Inner height: 28 mm

Phone +49- (0) 22 03-96 49-800  
Fax +49- (0) 22 03-96 49-222



▶ page 7.11

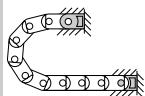

The attachment variants arising automatically by the choice of the KMA mounting bracket

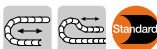

### The Standard - Option KMA\* - pivoting

- Recommended for unsupported and gliding applications
- Universal mountable with attachment capability on all sides
- Bolted connection outside of chain cross-section
- Confined installation conditions
- Corrosion resistant

\*KMA = Polymer Metal Mounting Bracket

Moving end  
2200/7600...2

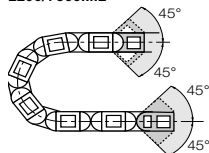

Fixed end  
2200/7600...1

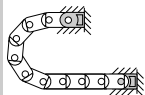

The attachment variants arising automatically by the choice of the KMA mounting bracket

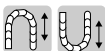

### Option KMA - locking

- Recommended for vertical hanging / standing applications
- Universally mountable
- Corrosion resistant
- Locked connections
- At very high acceleration

Moving end  
2300/7650...2

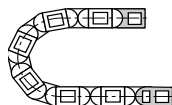

Fixed end  
2300/7650...1

## Dimensions and order configurations

### Part No. structure (pivoting)

2200.050.1.12  
7600.

Full set  
odd/even  
Width  
2200 = E-Chain\*  
7600 = E-Tube

### Part No. structure (locking)

2300.050.1.12  
7650.

Full set  
odd/even  
Width  
2300 = E-Chain\*  
7650 = E-Tube

**Note:** The E4/00 System may end with either an inner side or an outer side link. Keep in mind that an outer side link always forms the first chain link at the moving end. The Part No. depends on an even or odd numbers of links. Please insert: **1** for odd number of links or **2** for even number of links

### Full set, for both ends:

2200.040.2.12 (even)

### Single-part order:

2200.040.2.1 (even)

Mounting bracket with bore

2200.040.2.2 (even)

Mounting bracket with pin

### Fixed end

2200/7600...1 (pivoting)

2300/7650...1 (locking)

### Moving end

(pivoting) 2200/7600...2

(locking) 2300/7650...2

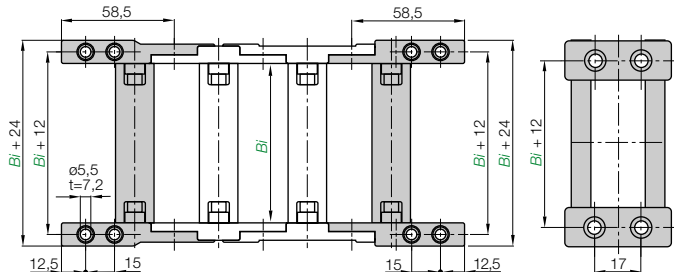

Width index	Part No. pivoting	Part No. locking	Full set	Bi [mm]	Width index	Part No. pivoting	Part No. locking	Full set	Bi [mm]
.040.	2200	2300	.040.□.12	40	.150.	2200/7600	2300/7650	.150.□.12	150
.050.	2200/7600	2300/7650	.050.□.12	50	.175.	2200/7600	2300/7650	.175.□.12	175
.062.	2200	2300	.062.□.12	62	.200.	2200/7600	2300/7650	.200.□.12	200
.070.	2200	2300	.070.□.12	70	.225.	2200/7600	2300/7650	.225.□.12	225
.075.	2200/7600	2300/7650	.075.□.12	75	.250.	2200/7600	2300/7650	.250.□.12	250
.087.	2200	2300	.087.□.12	87	.275.	2200	2300	.275.□.12	275
.100.	2200/7600	2300/7650	.100.□.12	100	.300.	2200/7600	2300/7650	.300.□.12	300
.125.	2200/7600	2300/7650	.125.□.12	125					

Please insert **1** for odd number of links or **2** for even number of links

## System E4/00 | Series 220-R760 | Accessories | Strain Relief



Strain relief tiewrap plate Part No. 2050.Z can be fixed on the last crossbar. **Details** ▶ chapter 10

Part No.	Width [mm]	Number of teeth
2050.Z	60	6

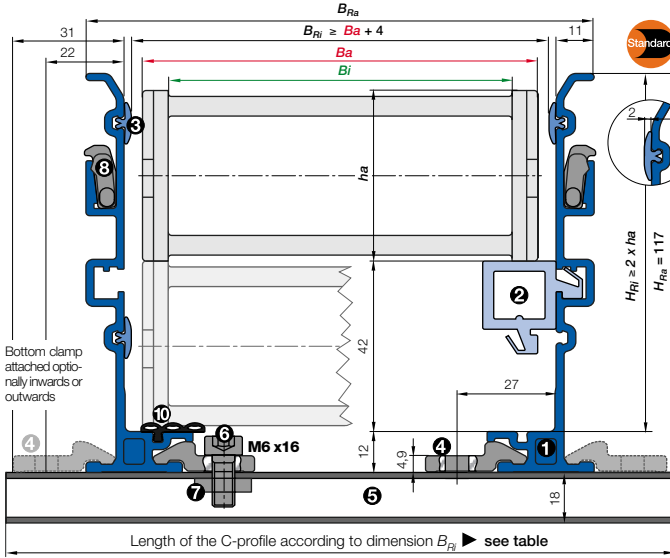

- $B_a$  = Outer width E-Chains\* / E-Tube
  - $B_i$  = Inner width E-Chains\* / E-Tube
  - $h_a$  = Outer height E-Chains\* / E-Tube
  - $H_{Ri}$  = Inner trough height
  - $H_{Ra}$  = Outer trough height
  - $B_{Ri}$  = Inner trough width ► depends on dim.  $B_a$
  - $B_{Ra}$  = Outer trough width
  - $n_{Mon}$  = Number of installation sets (left/right)
  - $n_{Ri}$  = Number of trough sets (left/right)
- $H_{Ri} \geq 2 \times h_a$   
 $B_{Ri} \geq B_a + 4$
- = Guide trough set
  - = Installation set "Basic"
  - = C-profile
  - = Glide bar
  - = C-profile

**Installation set "Basic" with C-profile**

Bottom Clamp attached optionally inwards or outwards

220.070.250.0 ► Order example

$B_{Ri}$ [mm]	Part No.	
	attached inwards	attached outwards
.040	64	960.30.175
.050	74	960.30.125
.060	84	960.30.150
.062	86	960.30.150
.070	94	960.30.150
.075	99	960.30.150
.087	111	960.30.175
.100	124	960.30.175
.125	149	960.30.200
.150	174	960.30.225
.175	199	960.30.250
.200	224	960.30.275
.225	249	960.30.300
.250	274	960.30.325
.275	299	960.30.350
.300	324	960.30.375

Phone +49- (0) 22 03-96 49-800  
 Fax +49- (0) 22 03-96 49-222

- **Components, trough "Basic":** ① Trough side parts, aluminum, 2 m ② Glide bar, plastic, 2 m ③ Glide strips, plastic, 2 m (without glide strips on request) ⑩ Optional: Silencer profile, rubber
- **Components, installation set "Basic":** ④ Bottom clamp, aluminum ⑤ C-profile, steel galvanized ⑥ Screw M6 x16 ⑦ Sliding nut M6 ⑧ Interface connector, plastic

**Order example: Length of travel 30 m - Center mounted for Series 220.070.250.0 with  $B_{Ri} = 94$**

- Guide trough set (set of 2 trough side parts, incl. glide strips) **without** glide bar  
 Order text: 16 m guide trough without glide bar (8 x 2 m sections) **Part No. 972.02.30.SL**
- Guide trough set (set of 2 trough side parts, incl. glide strips) **with** glide bar  
 Order text: 16 m guide trough with glide bar (8 x 2 m sections) **Part No. 972.02.31.SL**
- Installation set "Basic" complete (guide trough-sets + 1)  
 Order text: 17 installation sets "Basic" **Part No. 960.30.175**
- Module for the fixed end  
 Order text: 1 set **Part No. 972.82**
- Option:** For an additional noise dampening with silencer profile, please add Index A - Example: **Part No. 972.02.30.SLA**

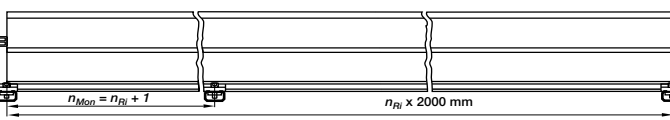

Principle sketch: Number of installation sets to be installed = **Number of trough sections + 1**

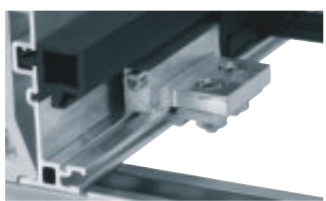

**NEW! A quick fix for mounting the stationary end of an E-Chain\***  
 With this new module for the fixed end, fast and easy mounting onto the Aluminum "SuperTrough" is now possible without any drilling. Fast mounting of the E-Chain\* by clamping onto the aluminum trough

- Quick relocation of the stationary end
- No drilling necessary

Insert for the installation set "Heavy-Duty": **972.50.XXX** instead of (960.30.XXX) on the right column "attached outwards"

- 
- 
- 
-

Price index



Low noise version E4/101  
Series 281 available with  
special rubber pads design



IPA Certificate, Cleanroom ISO  
Class 3 at v=1 m/s and ISO Class  
4 at v= 2 m/s for Series 280.10.100.0



ESD classification:  
Electrically conductive ESD/ATEX  
version upon request



Opening E-Chains\*: Remove crossbars and  
clips - Insert screwdriver into the slot, push  
down, release by lever action



Remove lids/bottoms (E-Tubes) - Insert screw-  
driver into the slot, release by lever action



When to use the Series 280/290/R770:

- If a low-noise version is required
- At very high speeds and/or accelerations
- For long travels
- For high additional loads
- Also available without camber



When not to use it:

- If long side-mounted, unsupported length is required  
▶ Series 2828/2928/R7728, page 7.82
- If an extrem vibration-free E-Chain® is necessary  
▶ Series E6.35, page 8.50

- 1 Crossbars on E-Chain® removable along both radii
- 2 Numerous interior separation possibilities
- 3 Closed and open styles can be combined
- 4 Stop dog with "brake" for noise reduction
- 5 Optimized glide pads
- 6 Wide, rounded plastic crossbars - cable friendly
- 7 Hinged snap-open removable lids along outer radius of E-Tube
- 8 KMA mounting brackets with attachment points on all sides
- 9 Locking or pivoting mounting brackets available
- 10 Integrated strain relief with C-profile option
- 11 E-Chains® also available with reverse bending radius "RBR"



Also available as  
E4/00-NC without  
camber: 280-NC

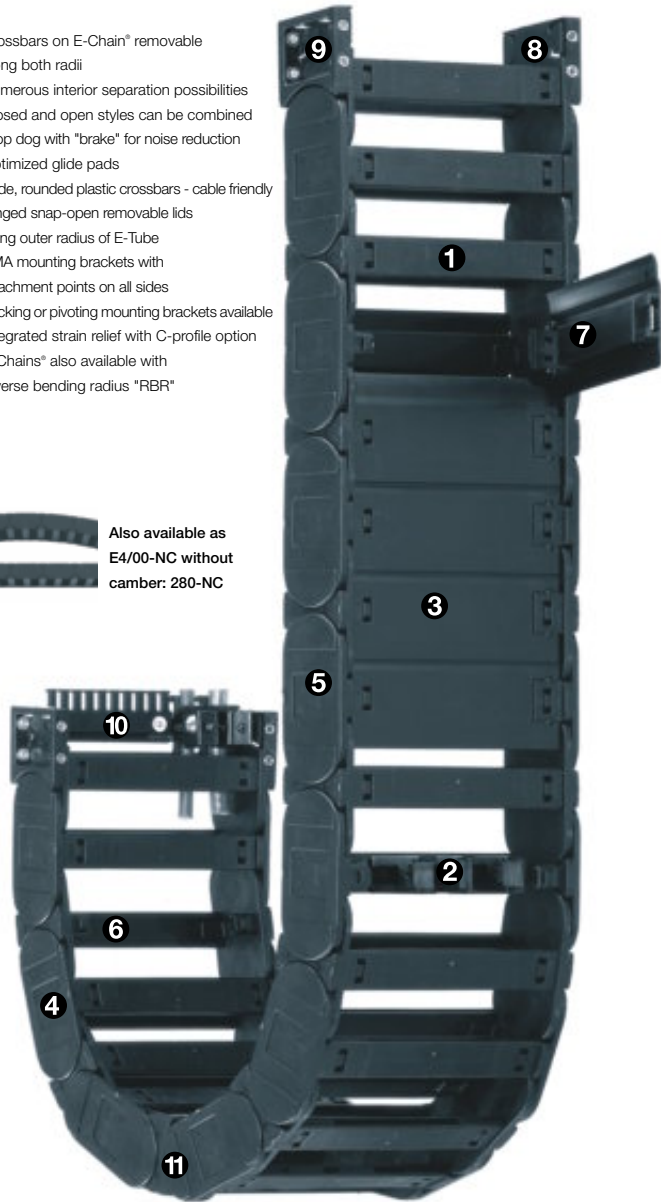

Order example complete E-Chain®

Please indicate chain-lengths or number of links Example: 4 m or 72 links

4 m 280.30.300.0

E-Chain®

with 2 separators 282 assembled every 2<sup>nd</sup> link

Interior separation

1 set 2800.30.1.12.C

Mounting bracket

### Unsupported length

$FL_G$  = with straight upper run

$FL_B$  = with permitted sag

Further information ► Design, page 1.12

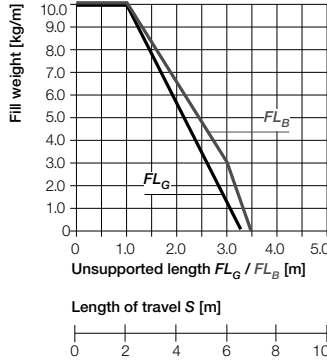
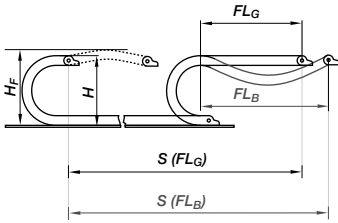

- $S$  = Length of travel
  - $R$  = Bending radius
  - $H$  = Nominal clearance height
  - $H_F$  = Required clearance height
  - $H_{in}$  = Trough inner height
  - $D$  = Overlength E-Chain<sup>®</sup> radius in final position
  - $K = \pi \cdot R + \text{"safety"}$
  - $D_2$  = Over length - long travels, gliding
  - $K_2$  = "Further add-on"
  - $H_2$  = "Mounting height"
- \*if the mounting bracket location is set lower

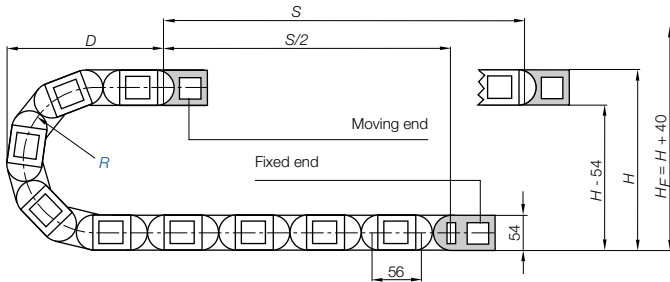

Pitch = 56 mm/link    Links/m = 18 (1008 mm)    Chain length =  $S/2 + K$

R	063	075	100	125	150	175	200	220	250	300
$H +^{+20}$	180	205	255	305	355	405	455	495	555	655
D	146	158	183	208	233	258	283	303	333	383
K	310	350	430	505	585	665	745	805	900	1055
$D_2 +^{+25}$	-	-	380	470	500	655	770	900	930	1100
$K_2$	-	-	616	784	896	1120	1288	1456	1568	1904
$H_2$	-	-	166	166	166	166	166	166	166	166

### Other installation methods

- Vertical, hanging  $\leq 80$  m
- Vertical, standing  $\leq 5$  m
- Side mounted, un supp.  $\leq 1,5$  m
- Rotary requires further calculation
- Unsupported length of upper run = upon request

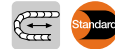

### Short travels - unsupported

Unsupported E-Chains<sup>®</sup> feature positive camber over short travels. This must be accounted for when specifying the clearance height  $H_F$ . Please consult igus<sup>®</sup> if space is particularly restricted.

The required clearance height:  
 $H_F = H + 40$  mm  
(with 2,0 kg/m fill weight)

### Long travel lengths from 10 m to max. 200 m    Chain length = $S/2 + K_2$

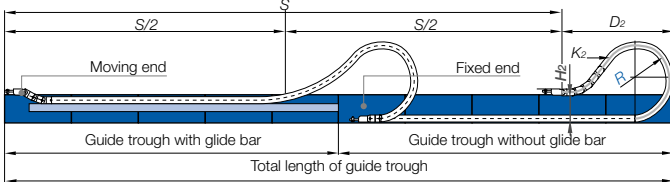

In case of travels between 4 and 10 m we recommend a longer unsupported length.



### Gliding, long travel applications (max. 200 m)

In this case the E-Chain<sup>®</sup> upper run will be introduced in a guide trough on the lower run. We recommend to realize the engineering of such a plant by our technicians.

Speed / acceleration $FL_G$	max. 20 [m/s] / max. 200 [m/s <sup>2</sup> ]
Speed / acceleration $FL_B$	max. 3 [m/s] / max. 6 [m/s <sup>2</sup> ]
Gliding speed / acceleration (maximum)	max. 10 [m/s] / max. 50 [m/s <sup>2</sup> ]
Material - permitted temperature °C	igumid G / -40° up to +120° C
Flammability class, igumid G	VDE 0304 IIC UL94 HB

### Technical Data



Details of material properties  
► page 1.38

32

System E4/00  
Inner height: 32 mm

Phone +49- (0) 22 03-96 49-800  
Fax +49- (0) 22 03-96 49-222



► page 7.11



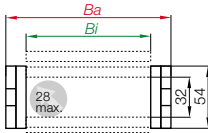

Part No. structure

280. 30. 300. 0



Series 280 - E-Chain® with crossbars every link

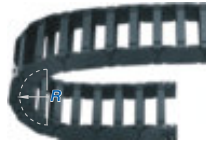

- Crossbars every link
- For rigid hydraulic hoses
- For applications particularly demanding
- Can be opened from two sides

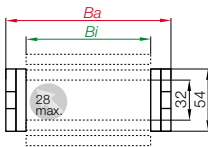

Part No. structure

290. 20. 300. 0



Series 290 - E-Chain® with crossbars every 2<sup>nd</sup> link

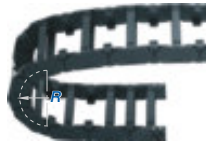

- Crossbars every 2<sup>nd</sup> link = Standard
- For nearly every situation
- Can be opened from two sides
- Easy assembly
- Stable
- Attractive price

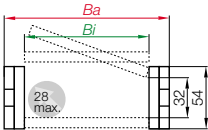

Part No. structure

770. 30. 300. 0



Series R770 - Fully enclosed E-Tube

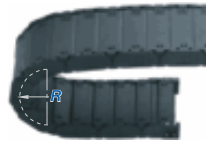

- Fully enclosed
- Excellent cable protection against dirt
- Protection against hot chips (up to 900°C)
- Lids along the entire inner radius are completely removable. Lids along the entire outer radius are single sided snap-open with a hinge on the other side to keep them attached to the chain or completely removable.



Low-noise! Special low-noise version with rubber pads

Series 281 - Order example 281.10.250.0

Further information:

[www.igus.de](http://www.igus.de) or phone +49-0 22 03-96 49-800

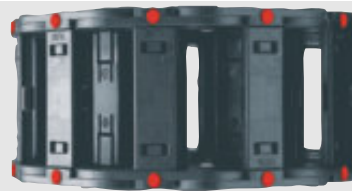

Part No.	<i>Bi</i> [mm]	<i>Ba</i> [mm]	280 [kg/m]	290 [kg/m]	R770 [kg/m]
280/290/770.05... [ ] .0*	50	73	≈ 1,73	≈ 1,64	≈ 2,63
280/290.06... [ ] .0	68	91	≈ 1,79	≈ 1,67	–
280/290/770.07... [ ] .0	75	98	≈ 1,84	≈ 1,69	≈ 2,75
280/290.087... [ ] .0	87	110	≈ 1,93	≈ 1,73	–
280/290/770.10... [ ] .0	100	123	≈ 2,02	≈ 1,78	≈ 2,83
280/290/770.11... [ ] .0	108	131	≈ 2,08	≈ 1,81	≈ 2,94
280/290.112... [ ] .0	112	136	≈ 2,15	≈ 1,84	–
280/290/770.12... [ ] .0	125	148	≈ 2,20	≈ 1,87	≈ 3,03
280/290.137... [ ] .0	137	161	≈ 2,29	≈ 1,91	–
280/290/770.15... [ ] .0	150	173	≈ 2,38	≈ 1,96	≈ 3,19
280/290.162... [ ] .0	162	186	≈ 2,44	≈ 1,99	–
280/290/770.17... [ ] .0	168	191	≈ 2,51	≈ 2,02	≈ 3,39
280/290.18... [ ] .0	175	198	≈ 2,56	≈ 2,05	–
280/290.187... [ ] .0	187	211	≈ 2,65	≈ 2,09	–
280/290/770.20... [ ] .0	200	223	≈ 2,74	≈ 2,14	≈ 3,59
280/290.212... [ ] .0	212	236	≈ 2,87	≈ 2,20	–
280/290.23... [ ] .0	225	248	≈ 2,92	≈ 2,22	–
280/290.237... [ ] .0	237	261	≈ 3,05	≈ 2,29	–
280/290/770.25... [ ] .0	250	273	≈ 3,10	≈ 2,32	≈ 4,04
280/290.262... [ ] .0	262	286	≈ 3,19	≈ 2,36	–
280/290.28... [ ] .0	275	298	≈ 3,28	≈ 2,41	–
280/290.29... [ ] .0	287	311	≈ 3,37	≈ 2,45	–
280/290/770.30... [ ] .0	300	323	≈ 3,46	≈ 2,50	≈ 4,43
280/290.312... [ ] .0	312	336	≈ 3,59	≈ 2,56	–
280/290.325... [ ] .0	325	348	≈ 3,68	≈ 2,60	–
280/290.337... [ ] .0	337	361	≈ 3,77	≈ 2,65	–
280/290.350... [ ] .0	350	373	≈ 3,86	≈ 2,69	–
280/290.362... [ ] .0	362	386	≈ 3,95	≈ 2,74	–
280/290.375... [ ] .0	375	398	≈ 4,04	≈ 2,79	–
280/290.387... [ ] .0	387	411	≈ 4,11	≈ 2,82	–
280/290.400... [ ] .0	400	423	≈ 4,18	≈ 2,86	–

Available bending radii

R [mm] 063\*\* 075\*\* 100\*\* 125 150 175 200 220 250 300

Supplement Part No. with required radius. Example: 280.30.300.0

0 = standard color, other colors ▶ page 1.39 · Pitch = 56 mm/link - Links/m = 18

\*Removable lid only, no hinged option · \*\*not available for R770

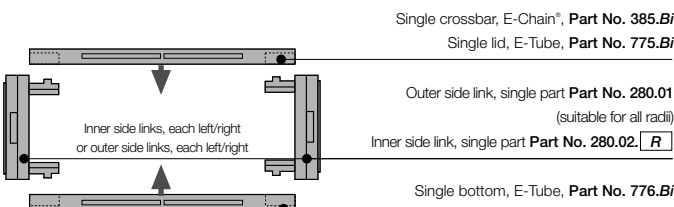

**TIP!**

## Hot Chips up to 850°C

E-Tubes that repel hot chips, up to 850 °C  
Some applications, depending on amount and size of the chips, can burn or melt the surface. That is no longer the case with the new igus® "Igmid HT" material.

Further information:  
www.igus.de/en/HT or phone:  
+49-0 22 03-96 49-800

**Increased inner height (program extension)**

The Series Part No. 28022 E-Chain®, with an increased inner height of 40 mm is available for unsupported applications. Please consult igus® for delivery time and availability. We recommend the use of steel mounting brackets for this series.

**Extender crossbar for large diameter hoses ▶ page 7.32**

System E4/00  
Inner height: 32 mm

Phone +49- (0) 22 03-96 49-800  
Fax +49- (0) 22 03-96 49-222

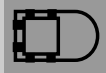

▶ page 7.11

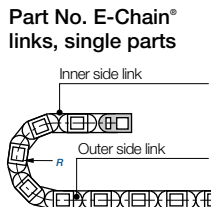



**Option 1**

- Vertical separators
- Spacers
- Locking separators
- Asymmetric separators

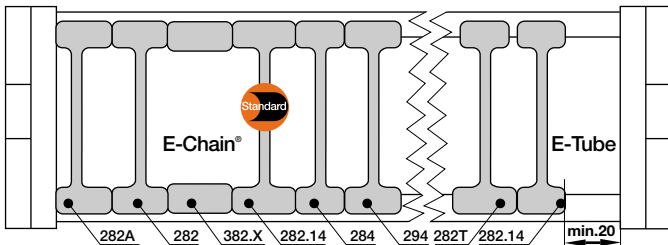

Vertical separator  
281



Vertical separator  
281T



Vertical separator  
281.14



Vertical separator  
283



Spacer  
381.10



Spacer  
381.15



Spacer  
381.20



Locking separator  
293



Asymmetric  
separator 281A

**Vertical separator  
for E-Chains®**

unassembled	281
assembled	282



**Vertical separator  
for E-Tubes**

unassembled	281T
assembled	282T



**Vertical separator  
for E-Chains®/E-Tubes**

unassembled	281.14
assembled	282.14



**Vertical separator  
for E-Chains®**

unassembled	283
assembled	284



**Spacer®  
for E-Chains®**

unassembled	381.10
assembled	382.10



**Spacer®  
for E-Chains®**

unassembled	381.15
assembled	382.15



**Spacer®  
for E-Chains®**

unassembled	381.20
assembled	382.20



**Locking separator  
for E-Chains®**

unassembled	293
assembled	294



**Asymmetric separator  
for E-Chains®**

unassembled	281A
assembled	282A



\*For side-mounted applications

**Option 1: Vertical separators and spacers**

Vertical separators are used if a vertical subdivision of the E-Chain® interior is required - By standard vertical separators are assembled every other E-Chain® link. Observe a lateral spacing of at least 20 mm for E-Tubes!

● **Standard separator 281 for E-Chains®** offers safe stability due to its wide base design, also when used with thick cables or hoses. If the distance needed between separators is greater than this separator's dimension, we offer the **vertical separator 281.14**.

● The **vertical separator 281T for E-Tubes** clamps to the fixed radius and remains free along the other radius to facilitate lid removal. If installing these yourself, please ensure that they are identically aligned. If the distance needed between separators is greater than this separator's dimension, we offer the **vertical separator 281.14**.

● **Vertical separator 283 with a narrow base for E-Chains®** with applications where a large number of small cables need to be individually separated.

● Vertical separators in side-mounted applications, for instance, can be fixed in position by means of **spacer 381.X for E-Chains®**. A wide range of intervals between the vertical separators is adjustable here.

● **Note on spacers:** The available interior height is reduced by 2 mm per spacer (4 mm when spacers are fitted on both sides). To avoid this, the parts can also be installed from the outside on the opening crossbar.

**Additionally:**

● **Locking separator 293 for E-Chains®** - with increased retention force for applications exposed to very high humidity or extreme loads. The extra retention force is achieved by asymmetric claws for the crossbar. Ensure proper alignment.

● **Asymmetric separator 281A for E-Chains®** (not for E-Tubes) with an 12-mm base, for combinations between spacers of different widths and vertical separators in side-mounted applications, for instance.

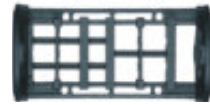
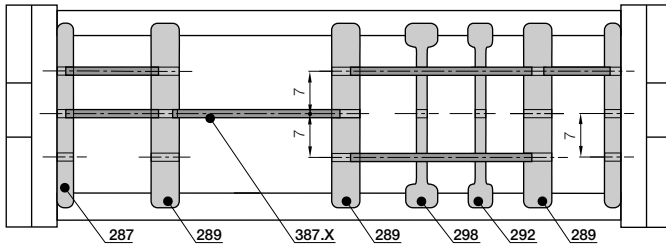

**Option 2**

- Side plates
- Middle plates
- Vertical separators
- Slotted separators
- Open slotted separators

**Option 2: Shelves**

For applications involving many cables with different diameters. The shelves can be arranged elevator-shifted with different bottoms.

● Side plates 286, middle plates 288 und shelves 386.X form the basic pattern of a shelf system. Shelves of various widths can be arranged at 3 different heights (in 7 mm increments).

● For special applications: **Vertical separator with injection moulded shelf 281.S.57** (57,5 mm) or **281.S.45** (45 mm).

● **Slotted separators 291** (not for E-Tubes), are used for very fine subdivisions. However, they cannot be retrofitted into an existing separation system without dismantling the interior separators first.

● The unilateral **open, slotted separator 297** can be retrofitted into an existing interior separation system without a need for dismantling the interior separators. During an installation of open slotted separators, the top and bottom notches cannot be occupied by shelves.



Side plate for E-Chains®/E-Tubes		
unassembled	286	
assembled		287



Middle plate for E-Chains®/E-Tubes		
unassembled	288	
assembled		289



Vertical separator for E-Chains®/E-Tubes		
unassembled	281.S.57	
assembled		282.S.57



Vertical separator for E-Chains®/E-Tubes		
unassembled	281.S.45	
assembled		282.S.45



Slotted separator for E-Chains®		
unassembled	291	
assembled		292



Open slotted separator for E-Chains®/E-Tubes		
unassembled	297	
assembled		298

Width X [mm]	Part No.	Part No.
	unassembled	assembled
18	386.18	387.18
23	386.23	387.23
25	386.25	387.25
28	386.28	387.28
33	386.33	387.33
43	386.43	387.43
50	386.50	387.50
54	386.54	387.54
62	386.62	387.62
75	386.75	387.75

Width X [mm]	Part No.	Part No.
	unassembled	assembled
87	386.87	387.87
100	386.100	387.100
108	386.108	387.108
125	386.125	387.125
150	386.150	387.150
175	386.175	387.175
200	386.200	387.200
208	386.208	387.208
225	386.225	387.225



Side plate 286



Middle plate 288



Vertical separator 281.S.57



Vertical separator 281.S.45



Slotted separator 291



Open slotted separator 297



Shelf 386.X

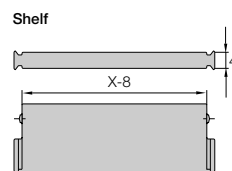

Shelf

System E4/00  
Inner height: 32 mm

Phone +49- (0) 22 03-96 49-800  
Fax +49- (0) 22 03-96 49-222



▶ page 7.11



### Extension links - for extremely wide E-Chains® up to 3,0 m

- For applications in which particularly high fill weights necessitate extremely wide E-Chains® (up to 3000 mm)
- The extension link design allows virtually limitless side-by-side attachment of chains
- The unsupported length of a chain can be increased when additional loads are required
- Extension links can be used with E-Chains®, E-Tubes or as a combination of both
- They are suitable for unsupported and gliding applications in a guide trough
- E-Chains® with extension links are attached with KMA or steel mounting brackets



Part No. structure  
280.10 /20 /10. [200].0  
280.Bi1/Bi2/Bi3. [R].0

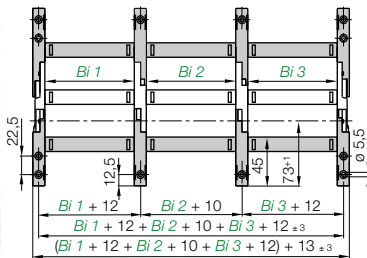

### Extender crossbars - careful guide of hoses applications

- Suitable for hoses with a maximum outer diameter of 115 mm
- Gliding operation with crossbars assembled along the outer radius and a special guide trough
- Gliding operation not guaranteed with crossbars assembled along the inner radius
- The extender crossbar can either be attached to the side links directly or can be used in combination with two stranded snap-open crossbars

Consult igus® for your extender crossbar applications. We are happy to assist you with your design layout

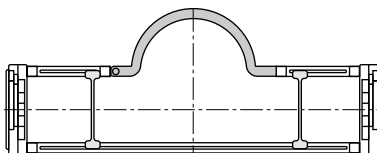

385.15RHD115 round extender crossbar combined with snap-open crossbars

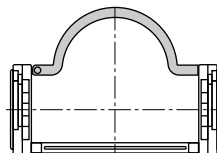

385.18RD115 round strap attached directly on the side link

Part No.	Max Ø [mm] hose	Form	Installation side link	Combination with
				snap-open crossb.
385.15.RHD115	115	○	-	+
385.18.RD115	115	○	+	-

○ = round + = yes / - = no



### Hinged crossbars

- Typically E-Chain® crossbars are completely removable. In cases where the snap-open crossbars have to remain at the open link of the E-Chain®, a hinged design has been developed
- Length: 37,5 mm **Part No. 385.02** / snap-open crossbar (shortened): Bi-37,5 mm **Part No. 385.03**
- Please consult igus® for design assistance

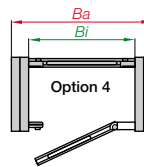
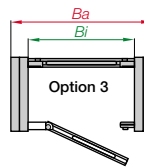
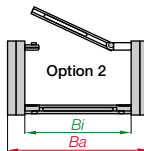
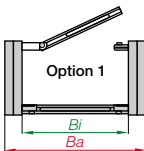
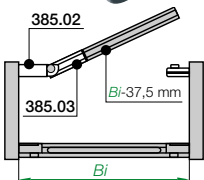

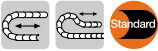

### The Standard - Option KMA\* - pivoting

- Recommended for unsupported and gliding applications
- Confined installation conditions
- Option - integrated C-profile strain relief device with Chainfix clip or strain relief tiwrap plates
- Corrosion resistant
- Universal mountable with attachment capability on all sides

\*KMA = Polymer Metal Mounting Bracket

Moving end  
2800/7700...1

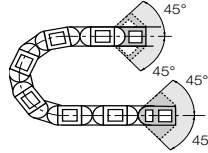

Fixed end  
2800/7700...2



The attachment variants arising automatically by the choice of the KMA mounting bracket

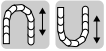
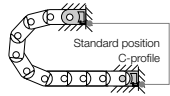

### Option KMA - locking

- Recommended for vertical hanging / standing applications

**Additionally:**

- Universal mountable
- C-profile option
- Corrosion resistant
- Locked connections
- At very high acceleration

Moving end  
2900/7750...1

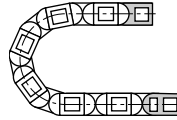

Fixed end  
2900/7750...2



The attachment variants arising automatically by the choice of the KMA mounting bracket

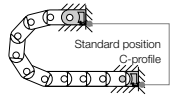

**Fixed end**

2800/7700...2 (pivoting)

2900/7750...2 (locking)

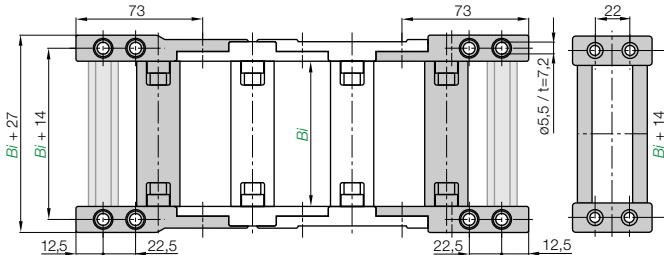

**Moving end**

(pivoting) 2800/7700...1

(locking) 2900/7750...1

### Dimensions and order configurations

**Part No. structure (pivoting)**

2800. 7700. 05. 1. 12. C



**Part No. structure (locking)**

2900. 7750. 05. 1. 12. C



**Note:** The E4/00 System may end with either an inner side or an outer side link. Keep in mind that an outer side link always forms the first chain link at the moving end. The Part No. depends on an even or odd numbers of links. Please insert: **1** for odd number of links or **2** for even number of links

**Full set, for both ends:**

2900. 05. 2. 1. 12. C (even)

**Single-part order:**

2900. 05. 2. 1. C (even)

Mounting bracket with bore

2900. 05. 1. 2. C (even)

Mounting bracket with pin

Width index	Part No. full set		C-profile <i>Bi</i> option [mm]		Width index	Part No. full set		C-profile <i>Bi</i> option [mm]	
	pivoting	locking				pivoting	locking		
.05.	2800/7700	2900/7750 .05.	.12. C	50	.23.	2800	2900	.23.	.12. C 225
.06.	2800	2900 .06.	.12. C	68	.237.	2800	2900	.237.	.12. C 237
.07.	2800/7700	2900/7750 .07.	.12. C	75	.25.	2800/7700	2900/7750 .25.	.12. C	250
.087.	2800	2900 .087.	.12. C	87	.262.	2800	2900	.262.	.12. C 262
.10.	2800/7700	2900/7750 .10.	.12. C	100	.28.	2800	2900	.28.	.12. C 275
.11.	2800/7700	2900/7750 .11.	.12. C	108	.29.	2800	2900	.29.	.12. C 287
.112.	2800	2900 .112.	.12. C	112	.30.	2800/7700	2900/7750 .30.	.12. C	300
.12.	2800/7700	2900/7750 .12.	.12. C	125	.312.	2800	2900	.312.	.12. C 312
.137.	2800	2900 .137.	.12. C	137	.325.	2800	2900	.325.	.12. C 325
.15.	2800/7700	2900/7750 .15.	.12. C	150	.337.	2800	2900	.337.	.12. C 337
.162.	2800	2900 .162.	.12. C	162	.350.	2800	2900	.350.	.12. C 350
.17.	2800/7700	2900/7750 .17.	.12. C	168	.362.	2800	2900	.362.	.12. C 362
.18.	2800	2900 .18.	.12. C	175	.375.	2800	2900	.375.	.12. C 375
.187.	2800	2900 .187.	.12. C	187	.387.	2800	2900	.387.	.12. C 387
.20.	2800/7700	2900/7750 .20.	.12. C	200	.400.	2800	2900	.400.	.12. C 400
.212.	2800	2900 .212.	.12. C	212					

Please insert **1** for odd number of links or **2** for even number of links



igus® Chainfix steel clamps and Chainfix stainless-steel clamps - max. pull forces, adjustable with hexagon socket. Available as single, double or triple clamps.

Details ► chapter 10

### Chainfix clamps for the C-profile

Part No. single clamps		Part No. double clamps		Part No. triple clamps		Cable
steel	stainless steel	steel	stainless steel	steel	stainless steel	ø [mm]
CFX12.1	CFX12.1.E	CFX12.2	CFX12.2.E	CFX12.3	-	06 - 12
CFX14.1	CFX14.1.E	CFX14.2	CFX14.2.E	CFX14.3	-	12 - 14
CFX16.1	CFX16.1.E	CFX16.2	CFX16.2.E	CFX16.3	-	14 - 16
CFX18.1	CFX18.1.E	CFX18.2	CFX18.2.E	CFX18.3	-	16 - 18
CFX20.1	CFX20.1.E	CFX20.2	CFX20.2.E	CFX20.3	-	18 - 20
CFX22.1	CFX22.1.E	CFX22.2	CFX22.2.E	CFX22.3	-	20 - 22
CFX26.1	CFX26.1.E	CFX26.2	CFX26.2.E	-	-	22 - 26
CFX30.1	CFX30.1.E	CFX30.2	CFX30.2.E	-	-	26 - 30
CFX34.1	CFX34.1.E	CFX34.2	CFX34.2.E	-	-	30 - 34
CFX38.1	CFX38.1.E	-	-	-	-	34 - 38
CFX42.1	CFX42.1.E	-	-	-	-	38 - 42



### Chainfix Clip - Modular snap-on strain relief device for C-profile

Available for all igus® E-ChainSystems® with C-profiles and also suitable for assembly in the KMA mounting brackets and clip-on strain relief for crossbars. High pull forces, plug-in modular snap-on strain relief device. Details ► chapter 10

Cable ø [mm]	Part No. clamp	Part No. bottom part
04 - 08	CFC-08-M	CFC-08-C
08 - 12	CFC-12-M	CFC-12-C
12 - 16	CFC-16-M	CFC-16-C
16 - 20	CFC-20-M	CFC-20-C
20 - 24	CFC-24-M	CFC-24-C



### Chainfix Nugget for the C-Profile

Strain relief for the fixation of cables up to a diameter of Ø 20 mm. Easy to assemble, without any screws and tools. Easy strain relief due to fixation with pre-harnessed cable strap, very small space requirement.

Details ► chapter 10

Part No.	ø max. conduit [mm]	Width [mm]
CFN.20	20	10,8

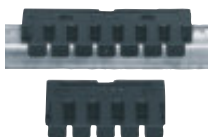

### Chainfix tiwrap plates with clip-on connection for the C-profile

Can be plugged into the KMA C-profile. Easy to assemble without any screws. Easily solvable with screwdriver nevertheless safe stop. For all E-Chains® with KMA and integrated C-profile. Details ► chapter 10

Part No.	Width of strain relief [mm]	Number of teeth
3050.ZC	50	5
3075.ZC	75	7



### Tiewrap plate as individual part

As individual component screwed on KMA. Can be plugged in the mounting brackets. Details ► chapter 10

Tiewrap plate	No. of teeth n	Dim. C [mm]	Dim. B [mm]	Center bore
3050.ZB	5	50	30	-
3075.ZB	7	75	55	-
3100.ZB	10	100	80	-
3115.ZB	11	115	95	-
3125.ZB	12	125	105	-
3150.ZB	15	150	130	-
3175.ZB	17	175	155	-
3200.ZB	20	200	180	+
3225.ZB	22	225	205	+
3250.ZB	25	250	230	+

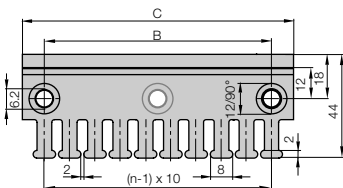
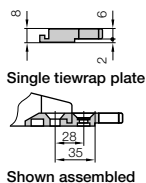

(- = no / + = yes)



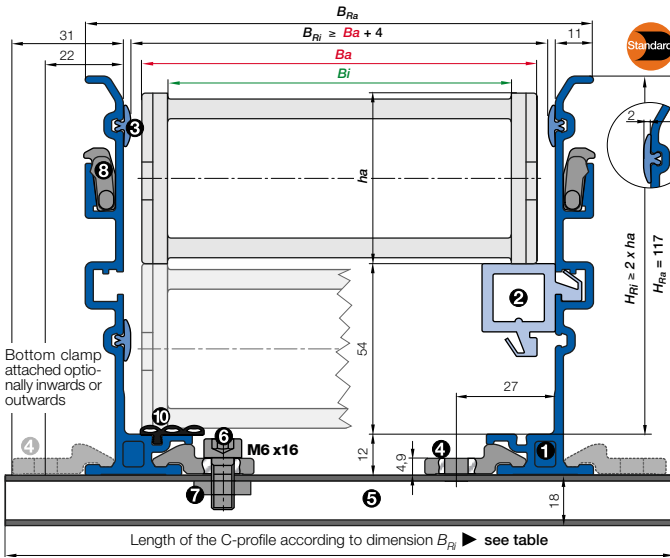

- $B_a$  = Outer width E-Chains\* / E-Tube
  - $B_i$  = Inner width E-Chains\* / E-Tube
  - $h_a$  = Outer height E-Chains\* / E-Tube
  - $H_{Ri}$  = Inner trough height
  - $H_a$  = Outer trough height
  - $B_{Ri}$  = Inner trough width ► depends on dim.  $B_a$
  - $B_{Ra}$  = Outer trough width
  - $n_{Mon}$  = Number of installation sets (left/right)
  - $n_{Ri}$  = Number of trough sets (left/right)
- $H_{Ri} \geq 2 \cdot h_a$   
 $B_{Ri} \geq B_a + 4$
- = Guide trough set
  - = Installation set "Basic"
  - = Glide bar
  - = C-profile

**Installation set "Basic" with C-profile**

Bottom Clamp attached optionally inwards or outwards

280.05.200.0 ► Order example

$B_{Ri}$ [mm]	Order example	
	$B_{Ri}$ attached inwards	$B_{Ri}$ attached outwards
.05	77 960.30.125	960.30.175
.06	95 960.30.150	960.30.200
.07	102 960.30.150	960.30.200
.08	114 960.30.175	960.30.225
.10	127 960.30.175	960.30.225
.11	135 960.30.200	960.30.250
.112	140 960.30.200	960.30.250
.12	152 960.30.200	960.30.250
.137	165 960.30.225	960.30.275
.15	177 960.30.225	960.30.275
.162	190 960.30.250	960.30.300
.17	195 960.30.250	960.30.300
.18	202 960.30.250	960.30.300
.187	215 960.30.275	960.30.325
.20	227 960.30.275	960.30.325
.212	240 960.30.300	960.30.350
.23	252 960.30.300	960.30.350
.237	265 960.30.325	960.30.375
.25	277 960.30.325	960.30.375
.262	290 960.30.350	960.30.400
.28	302 960.30.350	960.30.400
.29	315 960.30.375	960.30.425
.30	327 960.30.375	960.30.425
.312	340 960.30.400	960.30.450
.325	352 960.30.400	960.30.450
.337	365 960.30.425	960.30.475
.350	377 960.30.425	960.30.475
.362	390 960.30.450	960.30.500
.375	402 960.30.450	960.30.500
.387	415 960.30.475	960.30.525
.400	427 960.30.475	960.30.525

- **Components, trough "Basic":** ① Trough side parts, aluminum, 2 m ② Glide bar, plastic, 2 m ③ Glide strips, plastic, 2 m (without glide strips on request) ⑩ Optional: Silencer profile, rubber
- **Components, installation set "Basic":** ④ Bottom clamp, aluminum ⑤ C-profile, steel galvanized ⑥ Screw M6 x16 ⑦ Sliding nut M6 ⑧ Interface connector, plastic



**Order example: Length of travel 30 m - Center mounted for Series 280.30.300.0 with  $B_{Ri} = 327$**

Guide trough set (set of 2 trough side parts, incl. glide strips) <b>without</b> glide bar	Part No.	972.30.SL
Order text: 16 m guide trough without glide bar (8 x 2 m sections)		
Guide trough set (set of 2 trough side parts, incl. glide strips) <b>with</b> glide bar	Part No.	972.31.SL
Order text: 16 m guide trough with glide bar (8 x 2 m sections)		
Installation set "Basic" complete (guide trough-sets + 1)	Part No.	960.30.150
Order text: 17 installation sets "Basic"		
Module for the fixed end	Part No.	972.80
Order text: 1 set		
Option: For an additional noise dampening with silencer profile, please add Index A - Example:	Part No.	972.30.SLA

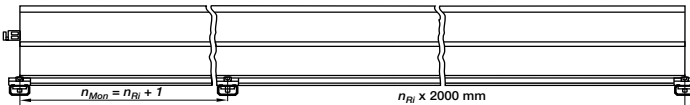

Principle sketch: Number of installation sets to be installed = Number of trough sections + 1

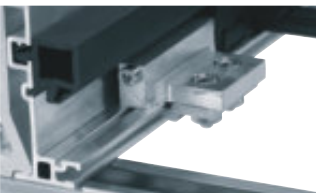

**NEW! A quick fix for mounting the stationary end of an E-Chain\***

With this new module for the fixed end, fast and easy mounting onto the Aluminum "SuperTrough" is now possible without any drilling. Fast mounting of the E-Chain\* by clamping onto the aluminum trough

- Quick relocation of the stationary end
- No drilling necessary ► page 9.16

Insert for the installation set "Heavy-Duty": **972.50.XXX** instead of (960.30.XXX) on the right column "attached outwards"



Price index



Low noise version E4/101  
Series 381 available with  
special rubber pads design



Cleanroom test  
upon request



ESD classification:  
Electrically conductive ESD/ATEX  
version upon request



Opening E-Chains®: Remove crossbars and  
clips - Insert screwdriver into the slot, push  
down, release by lever action



Remove lids/bottoms (E-Tubes) - Insert screw-  
driver into the slot, release by lever action



When to use the Series 380/390/R780:

- If a low-noise version is required
- At very high speed and/or acceleration
- For long travels
- For high additional loads
- Also available without camber



When not to use it:

- If long side-mounted, unsupported  
length is required  
▶ Series 3838/3938/R7838, page 7.104
- For increased inner height of 52 mm  
▶ Series 38022, page 12.42
- If an extrem vibration-free E-Chain® is necessary  
▶ Series E6.40/R6.40, page 8.56

- ❶ Crossbars on E-Chain® removable  
along both radii
- ❷ Stop dog with "brake" for noise reduction
- ❸ Closed and open styles can be combined
- ❹ Hinged snap-open removable lids  
along outer radius of E-Tube
- ❺ Numerous interior separation possibilities
- ❻ Optimized glide pads  
with lateral wear allowance
- ❼ Wide, rounded plastic crossbars - cable friendly
- ❽ Integrated strain relief possible
- ❾ KMA mounting brackets with  
attachment points on all sides
- ❿ Locking or pivoting mounting brackets available
- ⓫ E-Chains® also available with  
reverse bending radius "RBR"



Also available as  
E4/00-NC without  
camber: 380-NC



Order example complete E-Chain®

Please indicate chain-lengths or number of links Example: 5 m or 75 links

5 m 380.20.300.0

E-Chain®

with 2 separators 382 assembled every 2<sup>nd</sup> link

Interior separation

1 set 3800.20.1.12.C

Mounting bracket

### Unsupported length

$FL_G$  = with straight upper run

$FL_B$  = with permitted sag

Further information ► Design, page 1.12

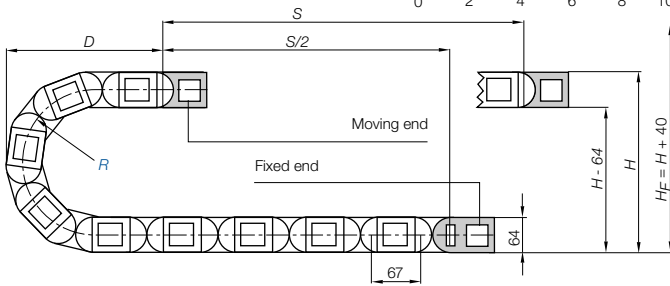
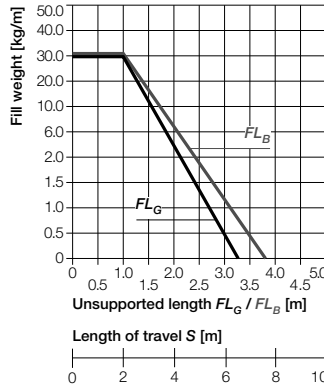
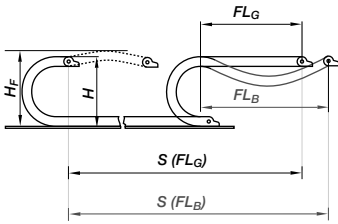

Pitch = 67 mm/link    Links/m = 15 (1005 mm)    Chain length =  $S/2 + K$

R	075	100	115	125	150	170	200	215	250	300	350
$H_{25}^{90}$	215	265	295	315	365	405	465	495	565	665	765
D	174	199	214	224	249	269	299	314	349	399	449
K	370	450	500	530	610	670	765	810	920	1080	1235
$D_2^{+25}$	-	-	-	475	570	620	780	865	1030	1150	1500
$K_2$	-	-	-	804	938	1072	1340	1407	1675	1943	2412
$H_2$	-	-	-	186	186	186	186	186	186	186	186

- S = Length of travel
  - R = Bending radius
  - H = Nominal clearance height
  - $H_F$  = Required clearance height
  - $H_{in}$  = Trough inner height
  - D = Overlength E-Chain<sup>®</sup> radius in final position
  - $K = \pi \cdot R + \text{"safety"}$
  - $D_2$  = Over length - long travels, gliding
  - $K_2$  = "Further add-on"
  - $H_2$  = "Mounting height"
- \*if the mounting bracket location is set lower

### Other installation methods

- Vertical, hanging  $\leq 100$  m
- Vertical, standing  $\leq 6$  m
- Side mounted, un supp.  $\leq 2$  m
- Rotary requires further calculation
- Unsupported length of upper run = upon request

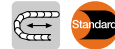

### Short travels - unsupported

Unsupported E-Chains<sup>®</sup> feature positive camber over short travels. This must be accounted for when specifying the clearance height  $H_F$ . Please consult igus<sup>®</sup> if space is particularly restricted.

The required clearance height:  
 $H_F = H + 40$  mm  
(with 2,0 kg/m fill weight)

### Long travel lengths from 10 m to max. 300 m    Chain length = $S/2 + K_2$

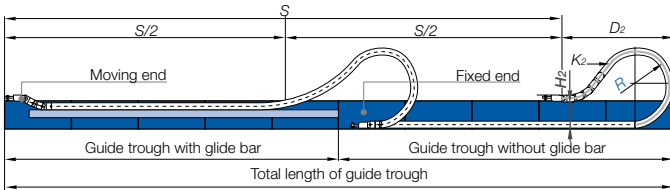

In case of travels between 4 and 10 m we recommend a longer unsupported length.



### Gliding, long travel applications (max. 300 m)

In this case the E-Chain<sup>®</sup> upper run will be introduced in a guide trough on the lower run. We recommend to realize the engineering of such a plant by our technicians.

Speed / acceleration $FL_G$	max. 20 [m/s] / max. 200 [m/s <sup>2</sup> ]
Speed / acceleration $FL_B$	max. 3 [m/s] / max. 6 [m/s <sup>2</sup> ]
Gliding speed / acceleration (maximum)	max. 10 [m/s] / max. 50 [m/s <sup>2</sup> ]
Material - permitted temperature °C	igumid G / -40° up to +120° C
Flammability class, igumid G	VDE 0304 IIC UL94 HB

### Technical Data



Details of material properties  
► page 1.38

42

System E4/00  
Inner height: 42 mm

Phone +49- (0) 22 03-96 49-800  
Fax +49- (0) 22 03-96 49-222



► page 7.11

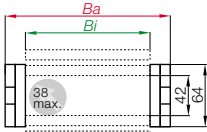

Part No. structure

380. 400. 300. 0



**Series 380 - E-Chain® with crossbars every link**

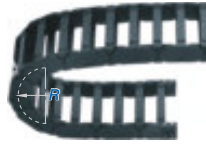

- Crossbars every link
- For rigid hydraulic hoses
- For applications particularly demanding
- Can be opened from two sides

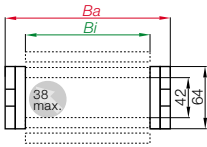

Part No. structure

390. 400. 300. 0



**Series 390 - E-Chain® with crossbars every 2<sup>nd</sup> link**

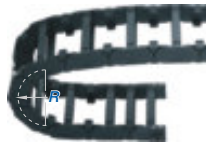

- Crossbars every 2<sup>nd</sup> link = Standard
- For nearly every situation
- Can be opened from two sides
- Easy assembly
- Stable
- Attractive price

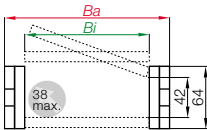

Part No. structure

780. 25. 300. 0



**Series R780 - Fully enclosed E-Tube**



- Fully enclosed
- Excellent cable protection against dirt
- Protection against hot chips (up to 900°C)
- Lids along the entire inner radius are completely removable. Lids along the entire outer radius are single sided snap-open with a hinge on the other side to keep them attached to the chain or completely removable.



**Low-noise! Special low-noise version with rubber pads**

Series 381 - Order example: 381.15.250.0

Further information:

[www.igus.de](http://www.igus.de) or phone +49-0 22 03-96 49-800

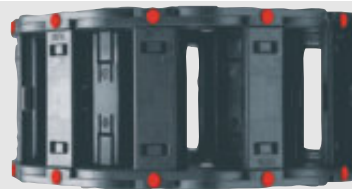

Part No.	Bi [mm]	Ba [mm]	380 [kg/m]	390 [kg/m]	R780 [kg/m]
380/390/780.05. [ ] .0*	50	76	≈ 2,06	≈ 1,98	≈ 2,25
380/390.06. [ ] .0	68	94	≈ 2,09	≈ 1,99	–
380/390/780.07. [ ] .0	75	101	≈ 2,12	≈ 2,01	≈ 2,38
380/390.087. [ ] .0	87	114	≈ 2,18	≈ 2,04	–
380/390/780.10. [ ] .0	100	126	≈ 2,25	≈ 2,08	≈ 2,60
380/390/780.11. [ ] .0	108	134	≈ 2,30	≈ 2,10	≈ 2,65
380/390.112. [ ] .0	112	139	≈ 2,30	≈ 2,10	–
380/390/780.12. [ ] .0	125	151	≈ 2,40	≈ 2,15	≈ 2,81
380/390.137. [ ] .0	137	164	≈ 2,44	≈ 2,17	–
380/390/780.15. [ ] .0	150	176	≈ 2,53	≈ 2,21	≈ 3,07
380/390.162. [ ] .0	162	189	≈ 2,55	≈ 2,22	–
380/390/780.17. [ ] .0	168	194	≈ 2,62	≈ 2,26	≈ 3,24
380/390.18. [ ] .0	175	201	≈ 2,62	≈ 2,26	–
380/390.187. [ ] .0	187	214	≈ 2,69	≈ 2,30	–
380/390/780.20. [ ] .0	200	226	≈ 2,77	≈ 2,33	≈ 3,53
380/390.212. [ ] .0	212	239	≈ 2,84	≈ 2,37	–
380/390.23. [ ] .0	225	251	≈ 2,92	≈ 2,41	–
380/390.237. [ ] .0	237	264	≈ 2,96	≈ 2,43	–
380/390/780.25. [ ] .0	250	276	≈ 3,05	≈ 2,47	≈ 4,33
380/390.262. [ ] .0	262	289	≈ 3,06	≈ 2,48	–
380/390.28. [ ] .0	275	301	≈ 3,17	≈ 2,53	–
380/390.29. [ ] .0	287	314	≈ 3,19	≈ 2,54	–
380/390/780.30. [ ] .0	300	326	≈ 3,32	≈ 2,61	≈ 4,89
380/390.312. [ ] .0	312	339	≈ 3,34	≈ 2,62	–
380/390.325. [ ] .0	325	351	≈ 3,41	≈ 2,66	–
380/390.337. [ ] .0	337	364	≈ 3,46	≈ 2,68	–
380/390.350. [ ] .0	350	376	≈ 3,68	≈ 2,79	–
380/390.362. [ ] .0	362	389	≈ 3,74	≈ 2,82	–
380/390.375. [ ] .0	375	402	≈ 3,79	≈ 2,84	–
380/390.387. [ ] .0	387	414	≈ 3,85	≈ 2,87	–
380/390.400. [ ] .0	400	426	≈ 3,90	≈ 2,90	–

Available bending radii  
 R [mm] 075\*\* 100\*\* 115\*\* 125 150 170 200 215 250 300 350

Supplement Part No. with required radius. Example: 380.400. [300].0  
 0 = standard color, other colors ▶ page 1.39 · Pitch = 67 mm/link · Links/m = 15  
 \*Removable lid only, no hinged option · \*\*not available for R780

**TIP!**  
**Hot Chips up to 850°C**  
 E-Tubes that repel hot chips, up to 850 °C  
 Some applications, depending on amount and size of the chips, can burn or melt the surface. That is no longer the case with the new igus® "igumid HT" material.  
 Further information: [www.igus.de/en/HT](http://www.igus.de/en/HT) or phone: +49-0 22 03-96 49-800

**TIP!**  
**igus® Line Extension**  
 Increased inner height 52 mm  
 The Series Part No. 38022 E-Chain®, with an increased inner height of 52 mm, is available for unsupported applications  
 ▶ page 12.42

**i**  
 Extender crossbar for large diameter hoses ▶ page 7.38

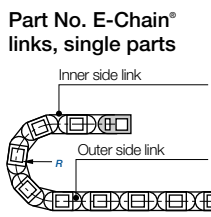
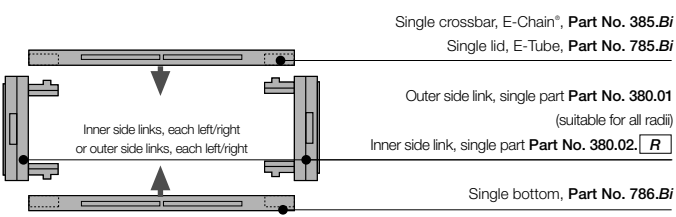

System E4/00  
 Inner height: 42 mm

Phone +49- (0) 22 03-96 49-800  
 Fax +49- (0) 22 03-96 49-222

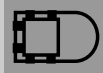

▶ page 7.11



**Option 1**

- Vertical separators
- Spacers
- Locking separators
- Asymmetric separators

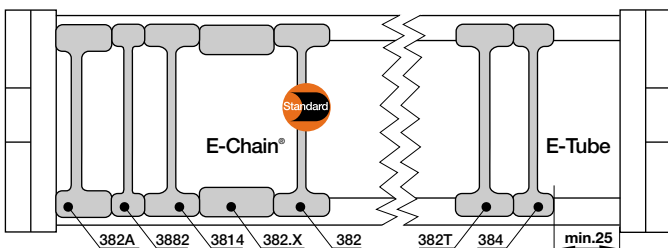

Vertical separator  
381

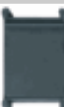

Vertical separator  
with a narrow base  
3881



Vertical separator  
381T



Spacer  
381.10



Spacer  
381.15



Spacer  
381.20



Locking separator  
3804



Locking separator  
383



Asymmetric  
separator 381A

**Vertical separator  
for E-Chains®**

unassembled	381
assembled	382



**Vertical separator\*  
for E-Chains®**

unassembled	3881
assembled	3882



**Vertical separator  
for E-Tubes**

unassembled	381T
assembled	382T



**Spacer\*  
for E-Chains®**

unassembled	381.10
assembled	382.10



**Spacer\*  
for E-Chains®**

unassembled	381.15
assembled	382.15



**Spacer\*  
for E-Chains®**

unassembled	381.20
assembled	382.20



**Locking separator  
for E-Chains®**

unassembled	3804
assembled	3814



**Locking separator  
for E-Tubes**

unassembled	383
assembled	384



**Asymmetric separator  
for E-Chains®**

unassembled	381A
assembled	382A



\*For side-mounted applications

**Option 1: Vertical separators and spacers**

Vertical separators are used if a vertical subdivision of the E-Chain® interior is required - By standard vertical separators are assembled every other E-Chain® link. **Note:** Observe a lateral spacing of at least 20 mm for E-Tubes!

● **Standard separator 381 for E-Chains®** offers safe stability due to its wide base design, also when used with thick cables or hoses.

● **Vertical separator 3881 with a narrow base (7 mm) for E-Chains®** with applications where a large number of small cables need to be individually separated.

● The **vertical separator 381T for E-Tubes** clamps to the fixed radius and remains free along the other radius to facilitate lid removal. If installing these yourself, please ensure that they are identically aligned.

● Vertical separators in side-mounted applications, for instance, can be fixed in position by means of **spacer 381.X for E-Chains®**. A wide range of intervals between the vertical separators is adjustable here.

● **Note on spacers:** The available interior height is reduced by 2 mm per spacer (4 mm when spacers are fitted on both sides). To avoid this, the parts can also be installed from the outside on the opening crossbar.

**Additionally:**

● **Locking separator 3804 for E-Chains®** - with increased retention force for applications exposed to very high humidity or extreme loads. The extra retention force is achieved by asymmetric claws for the crossbar. Ensure proper alignment.

● **Locking separator 393 for E-Chains®** - with increased retention force for applications exposed to very high humidity or extreme loads. The extra retention force is achieved by asymmetric claws for the crossbar. Ensure proper alignment.

● **Asymmetric separator 381A for E-Chains®** (not for E-Tubes) with an 14-mm base, for combinations between spacers of different widths and vertical separators in side-mounted applications, for instance.



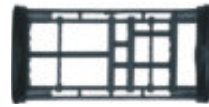
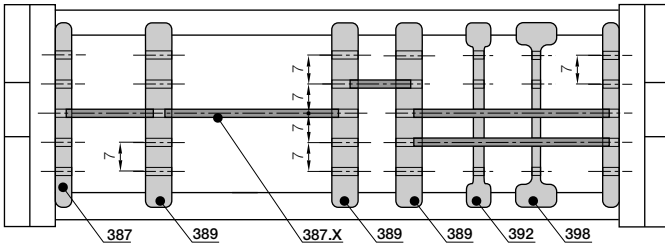

**Option 2**

- Side plates
- Middle plates
- Slotted separators
- Open slotted separators

**Option 2: Shelves**

For applications involving many cables with different diameters. The shelves can be arranged elevator-shifted with different bottoms.

- Side plates 386, middle plates 388 and shelves 386.X form the basic pattern of a shelf system. Shelves of various widths can be arranged at 5 different heights (in 7 mm increments).

- Slotted separators 391, are used for very fine subdivisions. However, they cannot be retrofitted into an existing separation system without dismantling the interior separators first.

- The unilateral open slotted separator 397 can be retrofitted into an existing interior separation system without a need for dismantling the interior separators. During an installation of open slotted separators, the top and bottom notches cannot be occupied by shelves.

	Side plate for E-Chains®/E-Tubes
	unassembled 386 assembled 387

	Middle plate for E-Chains®/E-Tubes
	unassembled 388 assembled 389

	Slotted separator for E-Chains®/E-Tubes
	unassembled 391 assembled 392

	Open slotted separator for E-Chains®/E-Tubes
	unassembled 397 assembled 398

Width X [mm]	Part No. unassembled	Part No. assembled
18	386.18	387.18
23	386.23	387.23
25	386.25	387.25
28	386.28	387.28
33	386.33	387.33
43	386.43	387.43
50	386.50	387.50
54	386.54	387.54
62	386.62	387.62

Width X [mm]	Part No. unassembled	Part No. assembled
75	386.75	387.75
87	386.87	387.87
100	386.100	387.100
108	386.108	387.108
125	386.125	387.125
150	386.150	387.150
175	386.175	387.175
200	386.200	387.200
208	386.208	387.208



Side plate 386



Middle plate 388

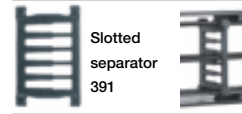

Slotted separator 391



Open slotted separator 397



Shelf 386.X

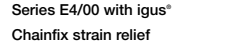
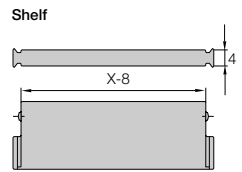

Series E4/00 with igus® Chainflex strain relief

System E4/00  
Inner height: 42 mm

Phone +49- (0) 22 03-96 49-800  
Fax +49- (0) 22 03-96 49-222

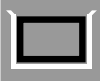

▶ page 7.11



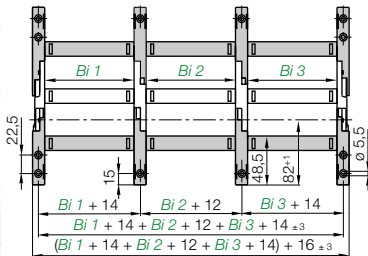

380.10 /20 /10. 200.0

380.Bi1/Bi2/Bi3. R.0

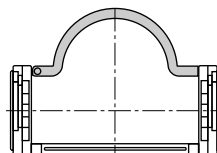
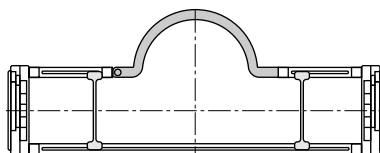

385.15.RHD115	115	○	-	+
385.18.RD115	115	○	+	-

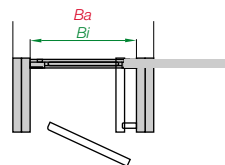
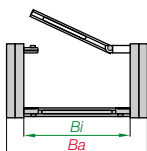
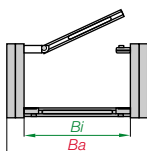

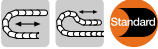

### The Standard - Option KMA\* - pivoting

- Recommended for unsupported and gliding applications
- Confined installation conditions
- Option - integrated C-profile strain relief device with Chainfix clip or strain relief tiwrap plates
- Corrosion resistant
- Universal mountable with attachment capability on all sides

\*KMA = Polymer Metal Mounting Bracket

Moving end  
3800/7800...1

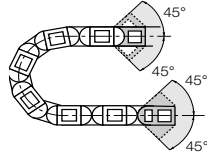

Fixed end  
3800/7800...2



The attachment variants arising automatically by the choice of the KMA mounting bracket

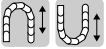
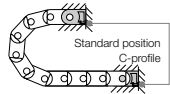

### Option KMA - locking

- Recommended for vertical hanging / standing applications

**Additionally:**

- Universal mountable
- C-profile option
- Corrosion resistant
- Locked connections
- At very high acceleration

Moving end  
3900/7900...1

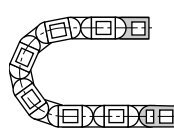

Fixed end  
3900/7900...2



The attachment variants arising automatically by the choice of the KMA mounting bracket

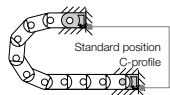

**Fixed end**

3800/7800...2 (pivoting)

3900/7900...2 (locking)

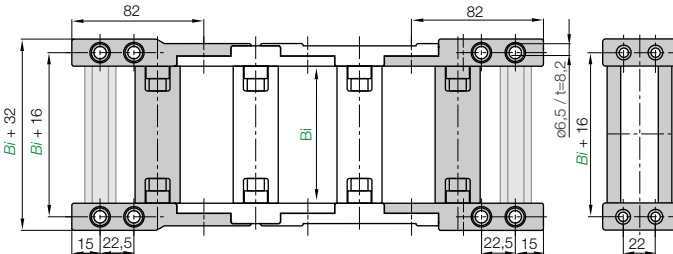

**Moving end**

(pivoting) 3800/7800...1

(locking) 3900/7900...1

### Dimensions and order configurations

**Part No. structure (pivoting)**

3800, 7800, 05, 1, 12, C



**Part No. structure (locking)**

3900, 7900, 05, 1, 12, C

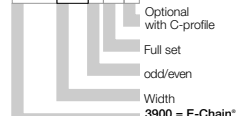

**Note:** The E4/00 System may end with either an inner side or an outer side link. Keep in mind that an outer side link always forms the first chain link at the moving end. The Part No. depends on an even or odd numbers of links. Please insert: **1** for odd number of links or **2** for even number of links

**Full set, for both ends:**  
3800, 05, 2, 12, C (even)

**Single-part order:**  
3800, 05, 2, 1, C (even)

Mounting bracket **with bore**  
3800, 05, 2, 2, C (even)

Mounting bracket **with pin**

Width index	Part No. full set		C-profile <i>Bi</i>		Width index	Part No. full set		C-profile <i>Bi</i>	
	pivoting	locking	option	[mm]		pivoting	locking	option [mm]	[mm]
.05.	3800/7800	3900/7900 .05.	.12, C	50	.23.	3800	3900	.23.	.12, C 225
.06.	3800	3900	.06.	.12, C 68	.237	3800	3900	.237.	.12, C 237
.07.	3800/7800	3900/7900 .07.	.12, C	75	.25.	3800/7800	3900/7900 .25.	.12, C	250
.087.	3800	3900	.087.	.12, C 87	.262	3800	3900	.262.	.12, C 262
.10.	3800/7800	3900/7900 .10.	.12, C	100	.28.	3800	3900	.28.	.12, C 275
.11.	3800/7800	3900/7900 .11.	.12, C	108	.29.	3800	3900	.29.	.12, C 287
.112.	3800	3900	.112.	.12, C 112	.30.	3800/7800	3900/7900 .30.	.12, C	300
.12.	3800/7800	3900/7900 .12.	.12, C	125	.312.	3800	3900	.312.	.12, C 312
.137.	3800	3900	.137.	.12, C 137	.325.	3800	3900	.325.	.12, C 325
.15.	3800/7800	3900/7900 .15.	.12, C	150	.337.	3800	3900	.337.	.12, C 337
.162.	3800	3900	.162.	.12, C 162	.350.	3800	3900	.350.	.12, C 350
.17.	3800/7800	3900/7900 .17.	.12, C	168	.362.	3800	3900	.362.	.12, C 362
.18.	3800	3900	.18.	.12, C 175	.375.	3800	3900	.375.	.12, C 375
.187.	3800	3900	.187.	.12, C 187	.387.	3800	3900	.387.	.12, C 387
.20.	3800/7800	3900/7900 .20.	.12, C	200	.400.	3800	3900	.400.	.12, C 400
.212.	3800	3900	.212.	.12, C 212					

Please insert **1** for odd number of links or **2** for even number of links



igus® Chainfix steel clamps and Chainfix stainless-steel clamps - max. pull forces, adjustable with hexagon socket. Available as single, double or triple clamps.

Details ► chapter 10

### Chainfix clamps for C-profile

Part No. single clamps		Part No. double clamps		Part No. triple clamps		Cable
steel	stainless steel	steel	stainless steel	steel	stainless steel	ø [mm]
CFX12.1	CFX12.1.E	CFX12.2	CFX12.2.E	CFX12.3	-	06 - 12
CFX14.1	CFX14.1.E	CFX14.2	CFX14.2.E	CFX14.3	-	12 - 14
CFX16.1	CFX16.1.E	CFX16.2	CFX16.2.E	CFX16.3	-	14 - 16
CFX18.1	CFX18.1.E	CFX18.2	CFX18.2.E	CFX18.3	-	16 - 18
CFX20.1	CFX20.1.E	CFX20.2	CFX20.2.E	CFX20.3	-	18 - 20
CFX22.1	CFX22.1.E	CFX22.2	CFX22.2.E	CFX22.3	-	20 - 22
CFX26.1	CFX26.1.E	CFX26.2	CFX26.2.E	-	-	22 - 26
CFX30.1	CFX30.1.E	CFX30.2	CFX30.2.E	-	-	26 - 30
CFX34.1	CFX34.1.E	CFX34.2	CFX34.2.E	-	-	30 - 34
CFX38.1	CFX38.1.E	-	-	-	-	34 - 38
CFX42.1	CFX42.1.E	-	-	-	-	38 - 42



### Chainfix Clip - Modular snap-on strain relief device for C-profile

Available for all igus® E-ChainSystems® with C-profiles and also suitable for assembly in the KMA mounting brackets and clip-on strain relief for crossbars. High pull forces, plug-in modular snap-on strain relief device. Details ► chapter 10

Cable ø [mm]	Part No. clamp	Part No. bottom part
04 - 08	CFC-08-M	CFC-08-C
08 - 12	CFC-12-M	CFC-12-C
12 - 16	CFC-16-M	CFC-16-C
16 - 20	CFC-20-M	CFC-20-C
20 - 24	CFC-24-M	CFC-24-C



### Chainfix Nugget for the C-Profile

Strain relief for the fixation of cables up to a diameter of Ø 20 mm. Easy to assemble, without any screws and tools. Easy strain relief due to fixation with pre-hammessed cable strap, very small space requirement. Details ► chapter 10

Part No.	ø max. conduit [mm]	Width [mm]
CFN.20	20	10,8

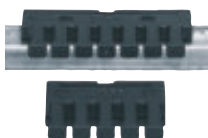

### Chainfix tiwrap plates with clip-on connection for the C-profile

Can be plugged into the KMA C-profile. Easy to assemble without any screws. Easily solvable with screwdriver nevertheless safe stop. For all E-Chains® with KMA and integrated C-profile. Details ► chapter 10

Part No.	Width of strain relief [mm]	Number of teeth
3050.ZC	50	5
3075.ZC	75	7



### Tiwrap plate as individual part

As individual component screwed on KMA. Can be plugged in the mounting brackets. Details ► chapter 10

Tiwrap plate	No. of teeth n	Dim. C [mm]	Dim. B [mm]	Center bore
3050.ZB	5	50	30	-
3075.ZB	7	75	55	-
3100.ZB	10	100	80	-
3115.ZB	11	115	95	-
3125.ZB	12	125	105	-
3150.ZB	15	150	130	-
3175.ZB	17	175	155	-
3200.ZB	20	200	180	+
3225.ZB	22	225	205	+
3250.ZB	25	250	230	+

(- = no / + = yes)

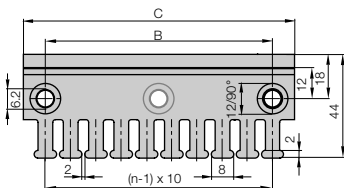
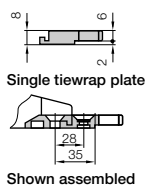

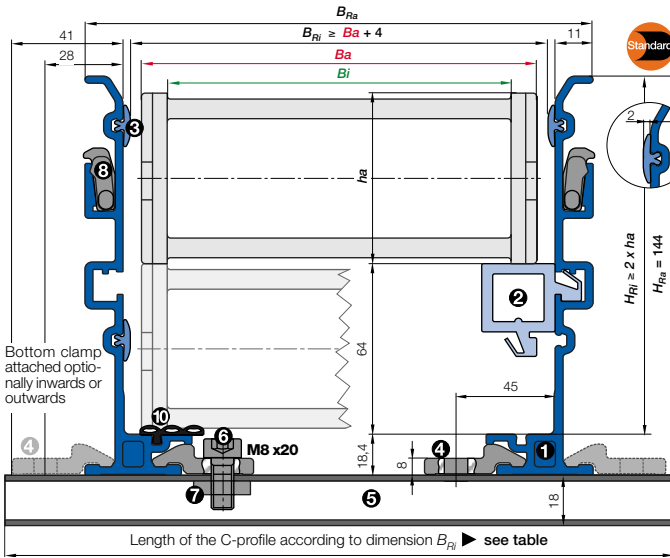

- $B_a$  = Outer width E-Chains\* / E-Tube
  - $B_i$  = Inner width E-Chains\* / E-Tube
  - $h_a$  = Outer height E-Chains\* / E-Tube
  - $H_{Ri}$  = Inner trough height
  - $H_{Ra}$  = Outer trough height
  - $B_{Ri}$  = Inner trough width ► depends on dim.  $B_a$
  - $B_{Ra}$  = Outer trough width
  - $n_{Mon}$  = Number of installation sets (left/right)
  - $n_{Ri}$  = Number of trough sets (left/right)
  - $H_{Ri} \geq 2 \cdot h_a$
  - $B_{Ri} \geq B_a + 4$
- = Guide trough set
  - = Installation set "Basic"
  - = Glide bar
  - = C-profile

**Installation set "Basic" with C-profile**

Bottom Clamp attached optionally inwards or outwards

380.05.300.0 ► Order example

$B_{Ri}$ [mm]	Order example	
	$B_{Ri}$ attached inwards	$B_{Ri}$ attached outwards
.06 80	-	960.40.200
.06 98	-	960.40.225
.07 105	-	960.40.225
.087 118	960.40.175	960.40.250
.10 130	960.40.200	960.40.250
.11 138	960.40.200	960.40.275
.112 143	960.40.200	960.40.275
.12 155	960.40.225	960.40.275
.137 168	960.40.225	960.40.300
.15 180	960.40.250	960.40.300
.162 193	960.40.250	960.40.325
.17 198	960.40.250	960.40.325
.18 205	960.40.275	960.40.325
.187 218	960.40.275	960.40.350
.20 230	960.40.300	960.40.350
.212 243	960.40.300	960.40.375
.23 255	960.40.325	960.40.375
.237 268	960.40.325	960.40.400
.25 280	960.40.350	960.40.400
.262 293	960.40.350	960.40.425
.28 305	960.40.375	960.40.425
.29 318	960.40.375	960.40.450
.30 330	960.40.400	960.40.450
.312 343	960.40.400	960.40.475
.325 355	960.40.425	960.40.475
.337 368	960.40.425	960.40.500
.360 380	960.40.450	960.40.500
.362 393	960.40.450	960.40.525
.375 406	960.40.475	960.40.525
.387 418	960.40.475	960.40.550
400 430	960.40.500	960.40.550



- **Components, trough "Basic":** ① Trough side parts, aluminum, 2 m ② Glide bar, plastic, 2 m ③ Glide strips, plastic, 2 m (without glide strips on request) ⑩ Optional: Silencer profile, rubber
- **Components, installation set "Basic":** ④ Bottom clamp, aluminum ⑤ C-profile, steel galvanized ⑥ Screw M8 x 20 ⑦ Sliding nut M8 ⑧ Interface connector, plastic



**Order example: Length of travel 30 m - Center mounted for Series 380.20.300.0 with  $B_{Ri} = 230$**

- Guide trough set (set of 2 trough side parts, incl. glide strips) **without** glide bar  
**Order text: 16 m guide trough without glide bar (8 x 2 m sections)** Part No. **973.30.SL**
- Guide trough set (set of 2 trough side parts, incl. glide strips) **with** glide bar  
**Order text: 16 m guide trough with glide bar (8 x 2 m sections)** Part No. **973.31.SL**
- Installation set "Basic" complete (guide trough-sets + 1)  
**Order text: 17 installation sets "Basic"** Part No. **960.40.175**
- Module for the fixed end  
**Order text: 1 set** Part No. **973.81**
- Option:** For an additional noise dampening with silencer profile, please add Index A - Example: Part No. **973.30.SLA**

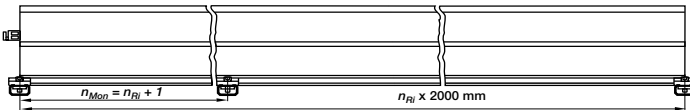

Prinzipzeichnung: Anzahl der zu montierenden Montagesets "Basic" = Anzahl der Rinnenstücke + 1

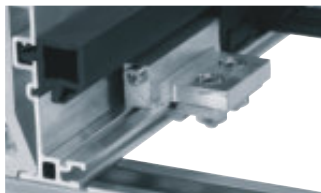

**NEW! A quick fix for mounting the stationary end of an E-Chain\***

With this new module for the fixed end, fast and easy mounting onto the Aluminum "SuperTrough" is now possible without any drilling. Fast mounting of the E-Chain\* by clamping onto the aluminum trough

- Quick relocation of the stationary end
- No drilling necessary ► page 9.16

Insert for the installation set "Heavy-Duty": **973.50.XXX** instead of (960.40.XXX) on the right column "attached outwards"



Price index



Low noise version E4/101  
Series 401 available with  
special rubber pads design



Cleanroom test  
upon request



ESD classification:  
Electrically conductive ESD/ATEX  
version upon request



Opening E-Chains\*: Remove crossbars and  
clips - Insert screwdriver into the slot, push  
down, release by lever action



Remove lids/bottoms (E-Tubes) - Insert screw-  
driver into the slot, release by lever action



When to use the Series 400/410/R880:

- If a low-noise version is required
- At very high speeds and/or accelerations
- For long travels
- For high additional loads
- Also available without camber



When not to use it:

- If long side-mounted, unsupported  
length is required  
▶ Series 4040/4140/R8840, page 7.116
- If an extrem vibration-free E-Chain® is necessary  
▶ Series E6.52, page 8.66

- ❶ Crossbars on E-Chain® removable  
along both radii
- ❷ Closed and open styles can be combined
- ❸ Numerous interior separation possibilities
- ❹ Hinged snap-open removable lids  
along outer radius
- ❺ Stop dog with "brake" for noise reduction
- ❻ Wide, rounded plastic crossbars
- ❼ Optimized glide pads  
with lateral wear allowance
- ❽ KMA mounting brackets with  
attachment points on all sides
- ❾ Locking or pivoting mounting brackets available
- ❿ Integrated strain relief possible
- ⓫ Dirt-repellent exterior
- ⓬ E-Chains® also available with  
reverse bending radius "RBR"



Also available as  
E4/00-NC without  
camber: 400-NC



Order example complete E-Chain®

Please indicate chain-lengths or number of links **Example: 3 m or 33 links**

3 m 400.30.300.0

E-Chain®

with 2 separators 411 assembled every 2<sup>nd</sup> link

Interior separation

1 set 4000.30.1.12.C

Mounting bracket

### Unsupported length

$FL_G$  = with straight upper run

$FL_B$  = with permitted sag

Further information ► Design, page 1.12

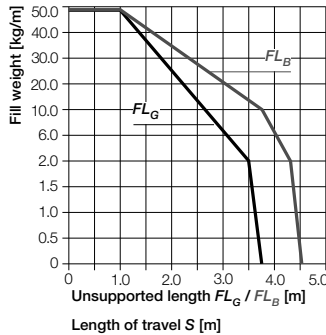
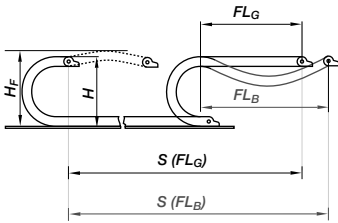

- $S$  = Length of travel
  - $R$  = Bending radius
  - $H$  = Nominal clearance height
  - $H_F$  = Required clearance height
  - $H_{in}$  = Trough inner height
  - $D$  = Overlength E-Chain® radius in final position
  - $K = \pi \cdot R + \text{"safety"}$
  - $D_2$  = Over length - long travels, gliding
  - $K_2$  = "Further add-on"
  - $H_2$  = "Mounting height"
- \*if the mounting bracket location is set lower

### Other installation methods

- Vertical, hanging  $\leq 100$  m
- Vertical, standing  $\leq 6$  m
- Side mounted, un supp.  $\leq 2,5$  m
- Rotary requires further calculation
- Unsupported length of upper run = upon request

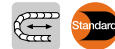

### Short travels - unsupported

Unsupported E-Chains® feature positive camber over short travels. This must be accounted for when specifying the clearance height  $H_F$ . Please consult igus® if space is particularly restricted.

The required

clearance height:

$$H_F = H + 50 \text{ mm}$$

(with 3,0 kg/m fill weight)

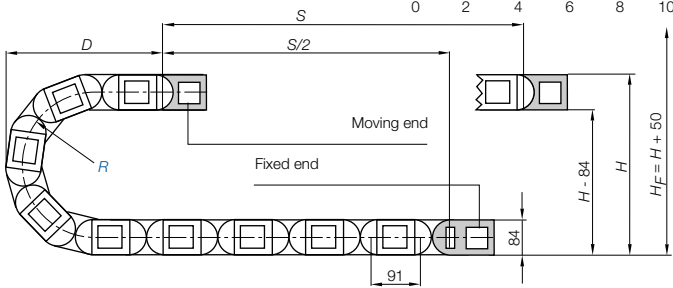

Pitch = 91 mm/link    Links/m = 11 (1001 mm)    Chain length =  $S/2 + K$

R	135	150	175	200	240	250	300	350	400	500
$H_{25}^0$	360	385	435	485	565	585	685	785	885	1085
D	270	285	310	335	375	385	435	485	535	635
K	650	750	825	900	1020	1050	1225	1340	1450	1775
$D_2^{+25}$	-	480	600	730	920	950	1180	1440	1530	1900
$K_2$	-	819	1092	1274	1547	1547	2002	2275	2548	3276
$H_2$	-	266	266	266	266	266	266	266	266	266

### Long travel lengths from 10 m to max. 400 m    Chain length = $S/2 + K_2$

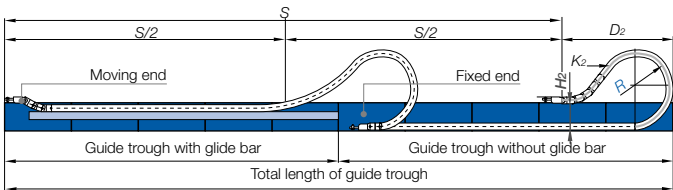

In case of travels between 4 and 10 m we recommend a longer unsupported length.



### Gliding, long travel applications (max. 400 m)

In this case the E-Chain® upper run will be introduced in a guide trough on the lower run. We recommend to realize the engineering of such a plant by our technicians.

Speed / acceleration $FL_G$	max. 20 [m/s] / max. 200 [m/s <sup>2</sup> ]
Speed / acceleration $FL_B$	max. 3 [m/s] / max. 6 [m/s <sup>2</sup> ]
Gliding speed / acceleration (maximum)	max. 10 [m/s] / max. 50 [m/s <sup>2</sup> ]
Material - permitted temperature °C	igumid G / -40° up to +120° C
Flammability class, igumid G	VDE 0304 IIC UL94 HB

### Technical Data



Details of material properties

► page 1.38



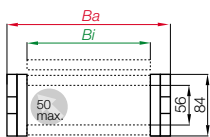

Part No. structure

400. 13. 250. 0



Series 400 - E-Chain® with crossbars every link

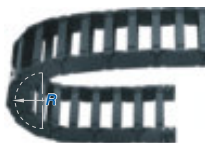

- Crossbars every link
- For rigid hydraulic hoses
- For applications particularly demanding
- Can be opened from two sides

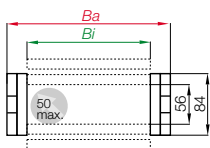

Part No. structure

410. 13. 250. 0



Series 410 - E-Chain® with crossbars every 2<sup>nd</sup> link



- Crossbars every 2<sup>nd</sup> link = Standard
- For nearly every situation
- Can be opened from two sides
- Easy assembly
- Stable
- Attractive price

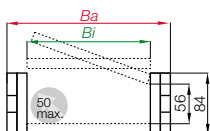

Part No. structure

880. 25. 250. 0



Series R880 - Fully enclosed E-Tube



- Fully enclosed
- Excellent cable protection against dirt
- Protection against hot chips (up to 900°C)
- Lids along the entire inner radius are completely removable. Lids along the entire outer radius are single sided snap-open with a hinge on the other side to keep them attached to the chain or completely removable.



Low-noise! Special low-noise version with rubber pads

Series 401 - Order example: 401.22.250.0

Further information:

[www.igus.de](http://www.igus.de) or phone +49-0 22 03-96 49-800





Part No.	<i>Bi</i> [mm]	<i>Ba</i> [mm]	400 [kg/m]	410 [kg/m]	R880 [kg/m]
400/410.05.....	50	84	≈ 3,44	≈ 3,12	-
400/410.06.....	65	99	≈ 3,50	≈ 3,20	-
400/410/880.07.....	75	109	≈ 3,53	≈ 3,44	≈ 3,98
400/410/880.10.....	100	134	≈ 3,71	≈ 3,53	≈ 4,27
400/410.11.....	112	147	≈ 3,84	≈ 3,60	-
400/410/880.12.....	125	159	≈ 3,91	≈ 3,63	≈ 4,63
400/410.13.....	137	172	≈ 4,04	≈ 3,70	-
400/410/880.15.....	150	184	≈ 4,10	≈ 3,73	≈ 5,06
400/410.16.....	162	197	≈ 4,21	≈ 3,78	-
400/410.17.....	175	209	≈ 4,32	≈ 3,84	-
400/410.18.....	187	222	≈ 4,43	≈ 3,89	-
400/410/880.20.....	200	234	≈ 4,46	≈ 3,91	≈ 5,63
400/410.21.....	212	247	≈ 4,57	≈ 3,96	-
400/410.22.....	225	259	≈ 4,63	≈ 3,99	-
400/410.23.....	237	272	≈ 4,76	≈ 4,06	-
400/410/880.25.....	250	284	≈ 4,85	≈ 4,10	≈ 6,36
400/410.26.....	262	297	≈ 4,94	≈ 4,15	-
400/410/880.27.....	275	309	≈ 5,05	≈ 4,20	≈ 6,72
400/410.28.....	287	322	≈ 5,07	≈ 4,21	-
400/410/880.30.....	300	334	≈ 5,29	≈ 4,32	≈ 7,02
400/410.31.....	312	347	≈ 5,29	≈ 4,32	-
400/410.32.....	325	359	≈ 5,38	≈ 4,37	-
400/410.33.....	337	372	≈ 5,56	≈ 4,46	-
400/410/880.35.....	350	384	≈ 5,71	≈ 4,53	≈ 7,72
400/410.36.....	362	397	≈ 5,71	≈ 4,53	-
400/410.37.....	375	409	≈ 5,73	≈ 4,54	-
400/410.38.....	387	422	≈ 5,82	≈ 4,59	-
400/410/880.40.....	400	434	≈ 6,02	≈ 4,69	≈ 8,72
400/410.41.....	412	447	≈ 6,17	≈ 4,76	-
400/410.42.....	425	459	≈ 6,33	≈ 4,84	-
400/410.43.....	437	472	≈ 6,39	≈ 4,87	-
400/410.45.....	450	484	≈ 6,46	≈ 4,91	-
400/410/880.46.....	462	497	≈ 6,48	≈ 4,92	≈ 9,19
400/410.47.....	475	509	≈ 6,61	≈ 4,98	-
400/410.48.....	487	522	≈ 6,65	≈ 5,01	-
400/410.50.....	500	534	≈ 6,74	≈ 5,05	-
400/410.51.....	512	547	≈ 6,77	≈ 5,06	-
400/410.52.....	525	559	≈ 6,81	≈ 5,08	-
400/410.53.....	537	572	≈ 6,96	≈ 5,16	-
400/410.55.....	550	584	≈ 7,45	≈ 5,40	-
400/410.60.....	600	634	≈ 7,65	≈ 5,50	-

Available bending radii

R [mm] 135\*\* 150 175 200 240 250 300 350 400 500

Supplement Part No. with required radius. Example: 400.30.300.0

0 = standard color, other colors ▶ page 1.39 · Pitch = 91 mm/link - Links/m = 11

\*Removable lid only, no hinged option · \*\*not available for R880

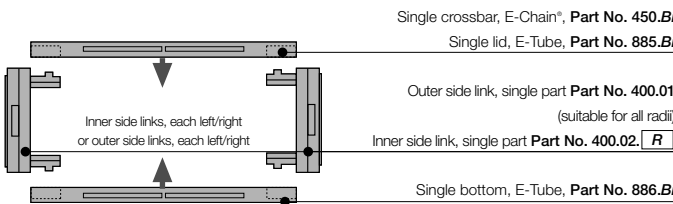

Part No. E-Chain® links, single parts

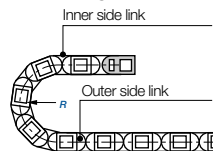

TIP!  
**Hot Chips up to 850°C**

E-Tubes that repel hot chips, up to 850 °C  
Some applications, depending on amount and size of the chips, can burn or melt the surface. That is no longer the case with the new igus® "Igmuid HT" material.

Further information:  
[www.igus.de/en/HT](http://www.igus.de/en/HT)  
or phone:  
+49-0 22 03-96 49-800



System E4/00  
Inner height: 56 mm

Phone +49- (0) 22 03-96 49-800  
Fax +49- (0) 22 03-96 49-222



▶ page 7.11



Option 1

- Vertical separators
- Spacers
- Locking separators
- Asymmetric separators

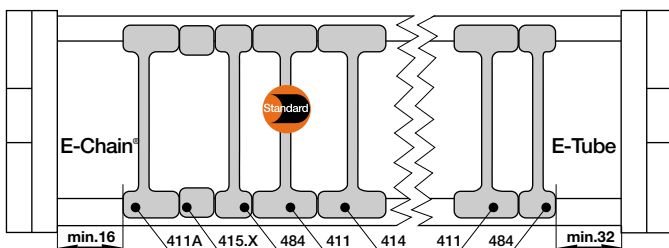

Vertical separator  
401



Vertical separator  
483



Spacer  
405.10



Spacer  
405.15



Spacer  
405.20



Spacer  
405.30



Spacer  
405.40



Locking separator  
404



Asymmetric  
separator 401A

Vertical separator for E-Chains®/E-Tubes	
unassembled	401
assembled	411



Vertical separator for E-Chains®/E-Tubes	
unassembled	483
assembled	484



Spacer* for E-Chains®	
unassembled	405.10
assembled	415.10



Spacer* for E-Chains®	
unassembled	405.15
assembled	415.15



Spacer* for E-Chains®	
unassembled	405.20
assembled	415.20



Spacer* for E-Chains®	
unassembled	405.30
assembled	415.30



Spacer* for E-Chains®	
unassembled	405.40
assembled	415.40



Locking separator for E-Chains®	
unassembled	404
assembled	414



Asymmetric separator for E-Chains®	
unassembled	401A
assembled	411A



\*For side-mounted applications

Option 1: Vertical separators and spacers

Vertical separators are used if a vertical subdivision of the E-Chain® interior is required - By standard vertical separators are assembled every other E-Chain® link. **Note:** Observe a lateral spacing of at least 32 mm (E-Tube) and for the E-Chain® 16 mm! Exception: No minimum spacing is needed for side plates.

● Standard separator 401 for E-Chains® and E-Tubes offers safe stability due to its wide base design, also when used with thick cables or hoses.

● Vertical separator 483 with a narrow base for E-Chains® and E-Tubes with applications where a large number of small cables need to be individually separated.

● Vertical separators in side-mounted applications, for instance, can be fixed in position by means of spacer 405.X for E-Chains®. A wide range of intervals between the vertical separators is adjustable here.

● Note on spacers: The available interior height is reduced by 2 mm per spacer (4 mm when spacers are fitted on both sides). To avoid this, the parts can also be installed from the outside on the opening crossbar.

Additionally:

● Locking separator for E-Chains® 404 - with increased retention force for applications exposed to very high humidity or extreme loads. The extra retention force is achieved by asymmetric claws for the crossbar. Ensure proper alignment

● Locking separator 406 for E4-Tubes - safe fitting locked on lid or bottom of the Tube and sideways slideable. The opposing lid or bottom can easily be opened and closed. Especially capable if many separators need to be assembled on a tight inner width. **Part No. not assembled 406 - Part No. assembled 416.** For illustration, refer to vertical separator 404.

● Asymmetric separator 401A for E-Chains® with an 18-mm base, for combinations between spacers of different widths and vertical separators in side-mounted applications, for instance.

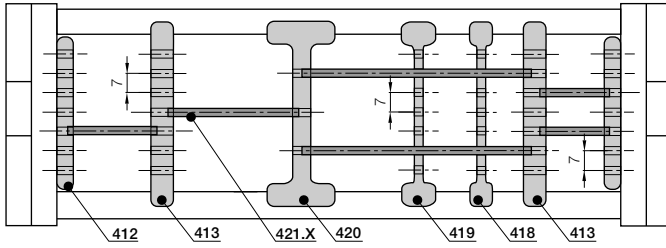

**Option 2**

- Side plates
- Middle plates
- Locking vertical separators
- Slotted separators
- Open slotted separators

**Option 2: Shelves**

For applications involving many cables with different diameters. The shelves can be arranged elevator-shifted with different bottoms.

- Side plates 402, middle plates 403 and shelves 420.X form the basic pattern of a shelf system. Shelves of various widths can be arranged at 7 different heights (in 7 mm increments).
- Locking vertical separator 410, slotted combined with shelves.
- Slotted separators 408, are used for very fine subdivisions. However, they cannot be retrofitted into an existing separation system without dismantling the interior separators first.
- The unilateral open slotted separator 409 can be retrofitted into an existing interior separation system without a need for dismantling the interior separators. During an installation of open slotted separators, the top and bottom notches cannot be occupied by shelves.



Side plate for E-Chains®/E-Tubes		
unassembled	402	
assembled	412	



Middle plate for E-Chains®/E-Tubes		
unassembled	403	
assembled	413	

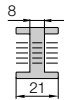

Locking vertical separator for E-Chains®/E-Tubes		
unassembled	410	
assembled	420	



Slotted separator for E-Chains®/E-Tubes		
unassembled	408	
assembled	418	

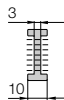

Open slotted separator for E-Chains®/E-Tubes		
unassembled	409	
assembled	419	

Width X [mm]	Part No. unassembled	Part No. assembled
18	420.18	421.18
23	420.23	421.23
25	420.25	421.25
28	420.28	421.28
33	420.33	421.33
43	420.43	421.43
50	420.50	421.50
62	420.62	421.62

Width X [mm]	Part No. unassembled	Part No. assembled
75	420.75	421.75
88	420.88	421.88
100	420.100	421.100
125	420.125	421.125
150	420.150	421.150
175	420.175	421.175
187	420.187	421.187
200	420.200	421.200



Side plate 402



Middle plate 403



Locking vertical separator 410



Slotted separator 408



Open slotted separator 409



Shelf 420.X

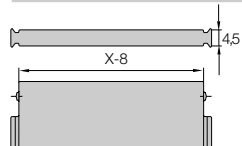

**Additional elements for interior separation**

	<b>Center crossbar</b>	
	unassembled	405
	assembled	415

**Center crossbar** - was developed for applications with a large number of thin cables. The center crossbar offers the option of subdividing the E-Chain® independently into upper and lower halves.

	<b>Rollclip</b>	
	unassembled	489.27
	assembled	490.27

**Rollclip** - minimizes abrasion of particularly sensitive hoses. The Rollclip is simply clamped onto the opening crossbar. The movable rollers compensate for relative movement between the chain and hose.

	<b>Roller separator</b>	
	unassembled	429
	assembled	430

**Roller separator** - performs a similar function to the Rollclip, but doubles as a separator.

System E4/00  
Inner height: 56 mm

Phone +49- (0) 22 03-96 49-800  
Fax +49- (0) 22 03-96 49-222



▶ page 7.11



Part No. structure  
400.10 /20 /10. 200.0  
400.B11/B12/B13. R.0

### Extension links - for extremely wide E-Chains® up to 3,0 m

- For applications in which particularly high fill weights necessitate extremely wide E-Chains® (up to 3000 mm)
- The extension link design allows virtually limitless side-by-side attachment of chains
- The unsupported length of a chain can be increased when additional loads are required
- Extension links can be used with E-Chains®, E-Tubes or as a combination of both
- They are suitable for unsupported and gliding applications in a guide trough
- E-Chains® with extension links are attached with KMA or steel mounting brackets

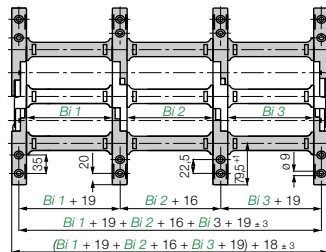

Consult igus® for your extender crossbar applications. We are happy to assist you with your design layout

### Extender crossbars - careful guide of hoses applications

- Suitable for hoses with a maximum outer diameter of 300 mm
- Gliding operation with crossbars assembled along the outer radius and a special guide trough
- Gliding operation not guaranteed with crossbars assembled along the inner radius
- The extender crossbar can either be attached to the side links directly or can be used in combination with two stranded snap-open crossbars

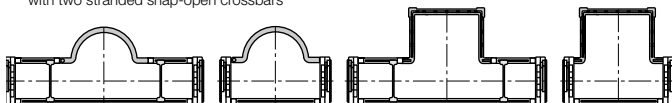

Round extender crossbar with snap-open crossbars    Attached directly to the side link    Square extender crossbar with snap-open crossbars    Attached directly to the side link

Part No.	Max Ø [mm] hose	Form	Installation side link	Combination with snap-open crossb.
450.15.RHD115	115	○	-	+
450.17.RD115	115	○	+	-
450.25.D150	150	□	+	-
450.30.D200	180	□	+	-
450.35.D250	195	□	+	-
450.40.D300	245	□	+	-
450.20.HD150	150	□	-	+
450.25.HD200	180	□	-	+
450.30.HD250	195	□	-	+

○ = round    □ = square    + = yes / - = no



### E4 clip-on cable binder

- For side-mounted applications    ● Serves as a clip-on, lateral guide for hoses and cables on E-Chains®
- The loops can be adjusted as required    ● Compatible with many E4 E-Chains®    ● Stylish and economical
- One clip and one locking band are needed for each chain link    ● Call us if you have any questions on project planning

Part No.	Form
450.B12	Locking clip, comprising a locking element
450.B12.200	Locking band, comprising a locking element and band; 12 x 1,5 x 200 mm

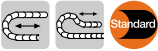

### The Standard - Option KMA\* - pivoting

- Recommended for unsupported and gliding applications
- Confined installation conditions
- Option - integrated C-profile strain relief device with Chainfix clip or strain relief tiwrap plates
- Corrosion resistant
- Universal mountable with attachment capability on all sides

\*KMA = Polymer Metal Mounting Bracket

Moving end  
4000/8800...1

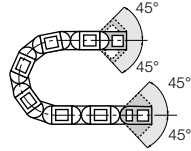

Fixed end  
4000/8800...2



The attachment variants arising automatically by the choice of the KMA mounting bracket

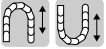
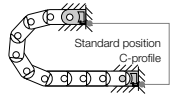

### Option KMA - locking

- Recommended for vertical hanging / standing applications

#### Additionally:

- Universal mountable
- C-profile option
- Corrosion resistant
- Locked connections
- At very high acceleration

Moving end  
4100/8900...1

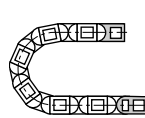

Fixed end  
4100/8900...2



The attachment variants arising automatically by the choice of the KMA mounting bracket

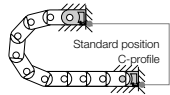

Fixed end  
4000/8800...2 (pivoting)  
4100/8900...2 (locking)

Moving end  
(pivoting) 4000/8800...1  
(locking) 4100/8900...1

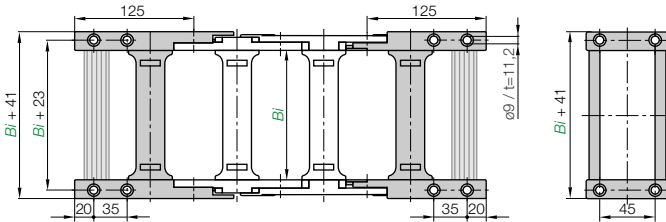

Width index	Part No. full set		C-profile option [mm]		Width index	Part No. full set		C-profile option [mm]	
	pivoting	locking		Bi		pivoting	locking		Bi
.05.	4000	4100	.05.	50	.32.	4000	4100	.32.	325
.06.	4000	4100	.06.	65	.33.	4000	4100	.33.	337
.07.	4000/8800	4100/8900	.07.	75	.35.	4000/8800	4100/8900	.35.	350
.10.	4000/8800	4100/8900	.10.	100	.36.	4000	4100	.36.	362
.11.	4000	4100	.11.	112	.37.	4000	4100	.37.	375
.12.	4000/8800	4100/8900	.12.	125	.38.	4000	4100	.38.	387
.13.	4000	4100	.13.	137	.40.	4000/8800	4100/8900	.40.	400
.15.	4000/8800	4100/8900	.15.	150	.41.	4000	4100	.41.	412
.16.	4000	4100	.16.	162	.42.	4000	4100	.42.	425
.17.	4000	4100	.17.	175	.43.	4000	4100	.43.	437
.18.	4000	4100	.18.	187	.45.	4000	4100	.45.	450
.20.	4000/8800	4100/8900	.20.	200	.46.	4000/8800	4100/8900	.46.	462
.21.	4000	4100	.21.	212	.47.	4000	4100	.47.	475
.22.	4000	4100	.22.	225	.48.	4000	4100	.48.	487
.23.	4000	4100	.23.	237	.50.	4000	4100	.50.	500
.25.	4000/8800	4100/8900	.25.	250	.51.	4000	4100	.51.	512
.26.	4000	4100	.26.	262	.52.	4000	4100	.52.	525
.27.	4000/8800	4100/8900	.27.	275	.53.	4000	4100	.53.	537
.28.	4000	4100	.28.	287	.55.	4000	4100	.55.	550
.30.	4000/8800	4100/8900	.30.	300	.60.	4000	4100	.60.	600
.31.	4000	4100	.31.	312					

Please insert [1] for odd number of links or [2] for even number of links

### Dimensions and order configurations

#### Part No. structure (pivoting)

4000, 8800, 07, 1, 12, C

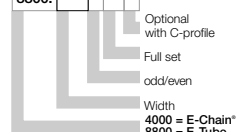

#### Part No. structure (locking)

4100, 8900, 07, 1, 12, C

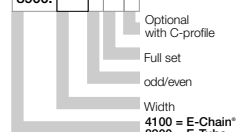

**Note:** The E4/00 System may end with either an inner side or an outer side link. Keep in mind that an outer side link always forms the first chain link at the moving end. The Part No. depends on an even or odd numbers of links. Please insert: [1] for odd number of links or [2] for even number of links

**Full set, for both ends:**  
[4000, 05, 1, 2, 12, C] (even)

**Single-part order:**  
[4000, 05, 1, 2, 1, C] (even)

Mounting bracket with bore  
[4000, 05, 1, 2, 2, C] (even)

Mounting bracket with pin





igus® Chainfix steel clamps and Chainfix stainless-steel clamps - max. pull forces, adjustable with hexagon socket. Available as single, double or triple clamps.

Details ► chapter 10

### Chainfix clamps for the C-profile

Part No. single clamps		Part No. double clamps		Part No. triple clamps		Cable
steel	stainless steel	steel	stainless steel	steel	stainless steel	ø [mm]
CFX12.1	CFX12.1.E	CFX12.2	CFX12.2.E	CFX12.3	-	06 - 12
CFX14.1	CFX14.1.E	CFX14.2	CFX14.2.E	CFX14.3	-	12 - 14
CFX16.1	CFX16.1.E	CFX16.2	CFX16.2.E	CFX16.3	-	14 - 16
CFX18.1	CFX18.1.E	CFX18.2	CFX18.2.E	CFX18.3	-	16 - 18
CFX20.1	CFX20.1.E	CFX20.2	CFX20.2.E	CFX20.3	-	18 - 20
CFX22.1	CFX22.1.E	CFX22.2	CFX22.2.E	CFX22.3	-	20 - 22
CFX26.1	CFX26.1.E	CFX26.2	CFX26.2.E	-	-	22 - 26
CFX30.1	CFX30.1.E	CFX30.2	CFX30.2.E	-	-	26 - 30
CFX34.1	CFX34.1.E	CFX34.2	CFX34.2.E	-	-	30 - 34
CFX38.1	CFX38.1.E	-	-	-	-	34 - 38
CFX42.1	CFX42.1.E	-	-	-	-	38 - 42



### Chainfix Clip - Modular snap-on strain relief device for C-profile

Available for all igus® E-ChainSystems® with C-profiles and also suitable for assembly in the KMA mounting brackets and clip-on strain relief for crossbars. High pull forces, plug-in modular snap-on strain relief device. Details ► chapter 10

Cable ø [mm]	Part No. clamp	Part No. bottom part
04 - 08	CFC-08-M	CFC-08-C
08 - 12	CFC-12-M	CFC-12-C
12 - 16	CFC-16-M	CFC-16-C
16 - 20	CFC-20-M	CFC-20-C
20 - 24	CFC-24-M	CFC-24-C



### Chainfix Nugget for the C-Profile

Strain relief for the fixation of cables up to a diameter of Ø 20 mm. Easy to assemble, without any screws and tools. Easy strain relief due to fixation with pre-hammessed cable strap, very small space requirement.

Details ► chapter 10

Part No.	ø max. conduit [mm]	Width [mm]
CFN.20	20	10,8

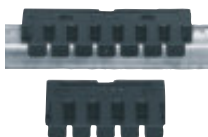

### Chainfix tiwrap plates with clip-on connection for the C-profile

Can be plugged into the KMA C-profile. Easy to assemble without any screws. Easily solvable with screwdriver nevertheless safe stop. For all E-Chains® with KMA and integrated C-profile. Details ► chapter 10

Part No.	Width of strain relief [mm]	Number of teeth
3050.ZC	50	5
3075.ZC	75	7



### Tiewrap plate as individual part

As individual component screwed on KMA. Can be plugged in the mounting brackets. Details ► chapter 10

Tiewrap plate	No. of teeth n	Dim. C [mm]	Dim. B [mm]	Center bore
3050.ZB	5	50	30	-
3075.ZB	7	75	55	-
3100.ZB	10	100	80	-
3115.ZB	11	115	95	-
3125.ZB	12	125	105	-
3150.ZB	15	150	130	-
3175.ZB	17	175	155	-
3200.ZB	20	200	180	+
3225.ZB	22	225	205	+
3250.ZB	25	250	230	+

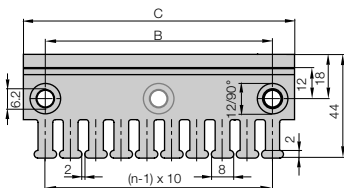
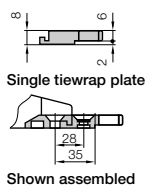

(- = no / + = yes)

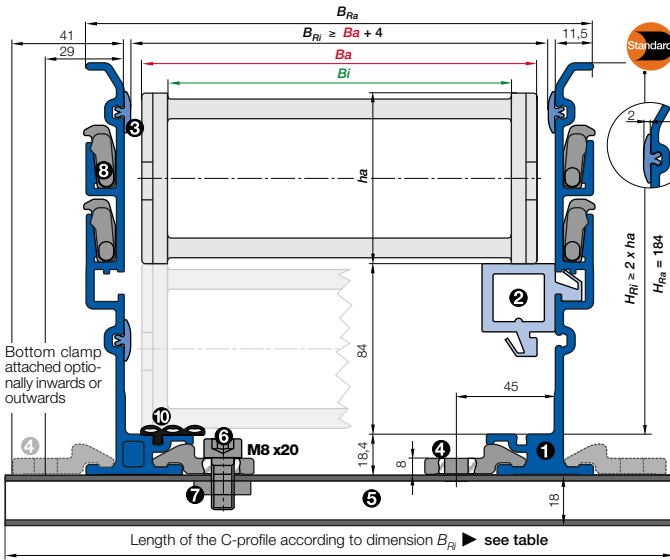

- $B_a$  = Outer width E-Chains / E-Tube
  - $B_i$  = Inner width E-Chains / E-Tube
  - $h_a$  = Outer height E-Chains / E-Tube
  - $H_{Ri}$  = Inner trough height
  - $H_{Ra}$  = Outer trough height
  - $B_{Ri}$  = Inner trough width ► depends on dim.  $B_a$
  - $B_{Ra}$  = Outer trough width
  - $n_{Mon}$  = Number of installation sets (left/right)
  - $n_{Ri}$  = Number of trough sets (left/right)
- $H_{Ri} \geq 2 \cdot h_a$   
 $B_{Ri} \geq B_a + 4$
- = Guide trough set
  - = Installation set "Basic"
  - = Glide bar
  - = C-profile

### Installation set "Basic" with C-profile

Bottom Clamp attached optionally inwards or outwards

400.05.200.0 ► Order example

Part No.	Order example		
	$B_{Ri}$ [mm]	attached	attached
.05	88	-	960.50.225
.06	103	-	960.50.225
.07	113	-	960.50.250
.10	138	960.50.200	960.50.275
.11	151	960.50.200	960.50.275
.12	163	960.50.225	960.50.300
.13	176	960.50.225	960.50.300
.15	188	960.50.250	960.50.325
.16	201	960.50.250	960.50.325
.17	213	960.50.275	960.50.350
.18	226	960.50.275	960.50.350
.20	238	960.50.300	960.50.375
.21	251	960.50.300	960.50.375
.22	263	960.50.325	960.50.400
.23	276	960.50.325	960.50.400
.25	288	960.50.350	960.50.425
.26	301	960.50.350	960.50.425
.27	313	960.50.375	960.50.450
.28	326	960.50.375	960.50.450
.30	338	960.50.400	960.50.475
.31	351	960.50.400	960.50.475
.32	363	960.50.425	960.50.500
.33	376	960.50.425	960.50.500
.35	388	960.50.450	960.50.525
.36	401	960.50.450	960.50.525
.37	413	960.50.475	960.50.550
.38	426	960.50.475	960.50.550
.40	438	960.50.500	960.50.575
.41	451	960.50.500	960.50.575
.42	463	960.50.525	960.50.600
.43	476	960.50.525	960.50.600
.45	488	960.50.550	960.50.625
.46	501	960.50.550	960.50.625
.47	513	960.50.575	960.50.650
.48	526	960.50.575	960.50.650
.50	538	960.50.600	960.50.675
.51	551	960.50.600	960.50.675
.52	563	960.50.625	960.50.700
.53	576	960.50.625	960.50.700
.55	588	960.50.650	960.50.725
.60	638	960.50.700	960.50.775



- Components, trough "Basic": ① Trough side parts, aluminum, 2 m ② Glide bar, plastic, 2 m ③ Glide strips, plastic, 2 m (without glide strips on request) ⑩ Optional: Silencer profile, rubber
- Components, installation set "Basic": ④ Bottom clamp, aluminum ⑤ C-profile, steel galvanized ⑥ Screw M8 x 20 ⑦ Sliding nut M8 ⑧ Interface connector, plastic



Order example: Length of travel 30 m - Center mounted for Series 400.10.200.0 with  $B_{Ri} = 138$

Guide trough set (set of 2 trough side parts, incl. glide strips) <b>without</b> glide bar	Part No.	974.30.SL
Order text: 16 m guide trough without glide bar (8 x 2 m sections)		
Guide trough set (set of 2 trough side parts, incl. glide strips) <b>with</b> glide bar	Part No.	974.31.SL
Order text: 16 m guide trough with glide bar (8 x 2 m sections)		
Installation set "Basic" complete (guide trough-sets + 1)	Part No.	960.50.200
Order text: 17 installation sets "Basic"		
Module for the fixed end	Part No.	974.80
Order text: 1 set		
Option: For an additional noise dampening with silencer profile, please add Index A - Example:	Part No.	974.30.SLA

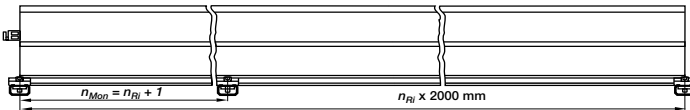

Principle sketch: Number of installation sets to be installed = Number of trough sections + 1

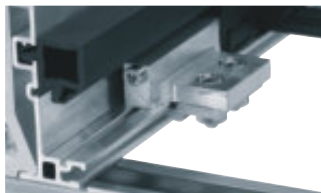

### NEW! A quick fix for mounting the stationary end of an E-Chain®

With this new module for the fixed end, fast and easy mounting onto the Aluminum "SuperTrough" is now possible without any drilling. Fast mounting of the E-Chain® by clamping onto the aluminum trough

- Quick relocation of the stationary end
- No drilling necessary ► page 9.16

Insert for the installation set "Heavy-Duty": 974.50.XXX instead of (960.50.XXX) on the right column "attached outwards"



► chapter 10



► chapter 9



► page 7.11



Price Index



This E4 Series is a  
"Low-noise-Version"



Cleanroom test  
upon request



ESD classification:  
Electrically conductive ESD/ATEX  
version upon request



Opening E-Chains®: Remove crossbars and clips - Insert screwdriver into the slot, push down, release by lever action



Remove lids/bottoms (E-Tubes) - Insert screwdriver into the slot, release by lever action



When to use the Series 600/601/R608:

- If a low-noise version is required
- At very high speeds and/or accelerations
- For long travels
- For high additional loads



When not to use it:

- If a simple and low-cost solution is required  
▶ Series 1640, page 7.194
- If an increased inner height is required  
▶ Series 640, page 7.64

- 1 Crossbars on E-Chain® removable along both radii
- 2 Hinged snap-open removable lids along outer radius
- 3 Stop dog with "brake" for noise reduction
- 4 Wide, rounded plastic crossbars - cable friendly
- 5 Optimized glide pads with lateral wear allowance
- 6 Numerous interior separation possibilities
- 7 Closed and open styles can be combined
- 8 Dirt-repellent exterior
- 9 E-Chains® also available with reverse bending radius "RBR"

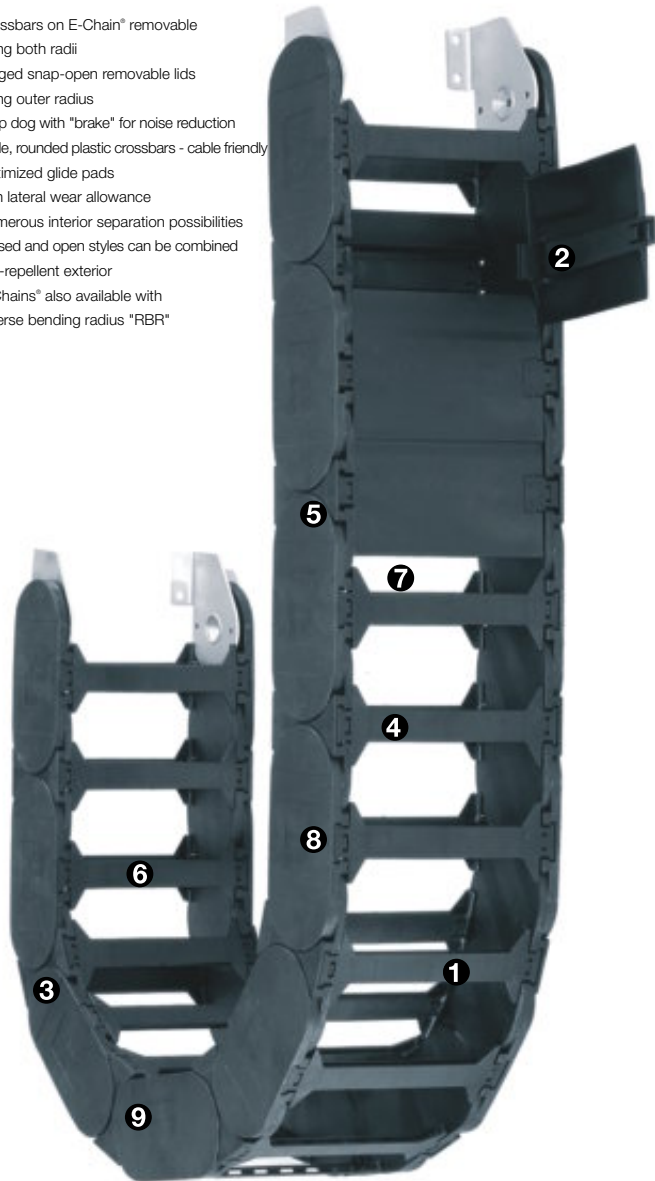

Order example complete E-Chain®

Please indicate chain-lengths or number of links Example: 6 m or 42 links

6 m 600.30.300.0

E-Chain®

with 2 separators 6011 assembled every 2<sup>nd</sup> link

Interior separation

1 set 6000.1.12

Mounting bracket

### Unsupported length

$FL_G$  = with straight upper run

$FL_B$  = with permitted sag

Further information ► Design, page 1.12

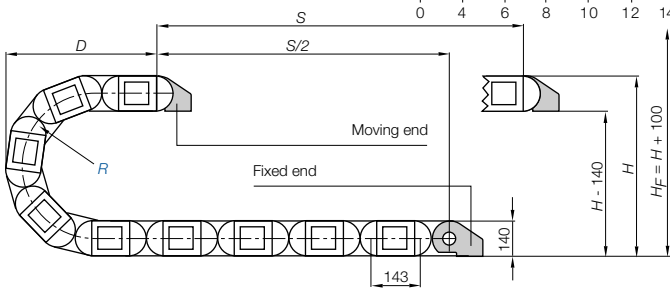
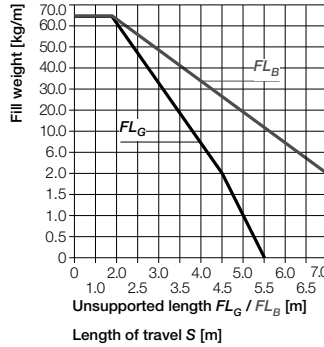
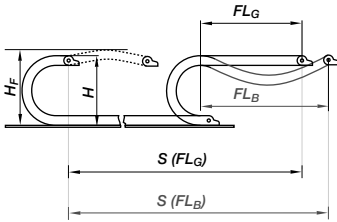

Pitch = 143 mm/link    Links/m = 7 (1001 mm)    Chain length =  $S/2 + K$

	200	250	300	350	400	450	500	550	600	750	1000
$H$	545	645	745	845	945	1045	1145	1245	1345	1645	2145
$D$	415	465	515	565	615	665	715	765	815	965	1215
$K$	920	1080	1240	1400	1560	1720	1870	2020	2175	2660	3435
$D_2^{+25}$	800	900	1100	1200	1430	1580	1700	1850	2050	2850	-
$K_2$	1287	1430	1859	2145	2574	2860	3146	3432	3861	5005	-
$H_2$	325	325	325	325	325	325	325	325	325	325	-

- $S$  = Length of travel
  - $R$  = Bending radius
  - $H$  = Nominal clearance height
  - $H_F$  = Required clearance height
  - $H_{in}$  = Trough inner height
  - $D$  = Overlength E-Chain® radius in final position
  - $K = \pi \cdot R + \text{"safety"}$
  - $D_2$  = Over length - long travels, gliding
  - $K_2$  = "Further add-on"
  - $H_2$  = "Mounting height"
- \*if the mounting bracket location is set lower

### Other installation methods

- Vertical, hanging  $\leq 120$  m
- Vertical, standing  $\leq 6$  m
- Side mounted, un supp.  $\leq 6$  m
- Rotary requires further calculation
- Unsupported length of upper run = upon request



### Short travels - unsupported

Unsupported E-Chains® feature positive camber over short travels. This must be accounted for when specifying the clearance height  $H_F$ . Please consult igus® if space is particularly restricted.

The required clearance height:  
 $H_F = H + 100$  mm  
(with 5,0 kg/m fill weight)

### Long travel lengths from 10 m to max. 450 m    Chain length = $S/2 + K_2$

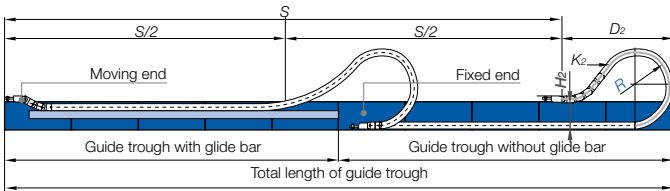

In case of travels between 4 and 10 m we recommend a longer unsupported length.



### Gliding, long travel applications (max. 450 m)

In this case the E-Chain® upper run will be introduced in a guide trough on the lower run. We recommend to realize the engineering of such a plant by our technicians.

Speed / acceleration $FL_G$	max. 20 [m/s] / max. 200 [m/s²]
Speed / acceleration $FL_B$	max. 3 [m/s] / max. 6 [m/s²]
Gliding speed / acceleration (maximum)	max. 10 [m/s] / max. 50 [m/s²]
Material - permitted temperature °C	igumid G / -40° up to +120° C
Flammability class, igumid G	VDE 0304 IIC UL94 HB

### Technical Data



Details of material properties  
► page 1.38

108

System E4/00  
Inner height: 108 mm

Phone +49- (0) 22 03-96 49-800  
Fax +49- (0) 22 03-96 49-222



► page 7.11

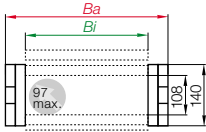

Part No. structure

600. 30. 300. 0

Color black  
Bending radius  
Width  
Series

**Series 600 - E-Chain® with crossbars every link**

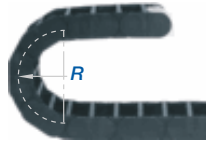

- Crossbars every link
- For rigid hydraulic hoses
- For applications particularly demanding
- Can be opened from two sides

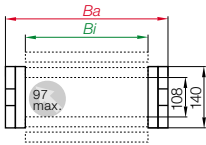

Part No. structure

601. 30. 300. 0

Color black  
Bending radius  
Width  
Series



**Series 601 - E-Chain® with crossbars every 2<sup>nd</sup> link**

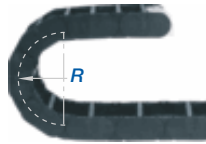

- Crossbars every 2<sup>nd</sup> link = Standard
- For nearly every situation
- Can be opened from two sides
- Easy assembly
- Stable
- Attractive price

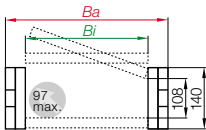

Part No. structure

608. 30. 300. 0

Color black  
Bending radius  
Width  
Series

**Series R608 - Fully enclosed E-Tube**

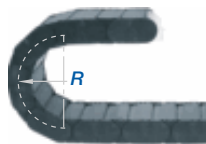

- Fully enclosed
- Excellent cable protection against dirt
- Protection against hot chips (up to 900°C)
- Lids along the entire inner radius are completely removable. Lids along the entire outer radius are single sided snap-open with a hinge on the other side to keep them attached to the chain or completely removable.



## Hot Chips up to 850°C

E-Tubes that repel hot chips, up to 850 °C

Some applications, depending on amount and size of the chips, can burn or melt the surface. That is no longer the case with the new igus® "igumid HT" material.

Further Information: [www.igus.de/en/HT](http://www.igus.de/en/HT)

TIP!

Part No.	<i>Bi</i> [mm]	<i>Ba</i> [mm]	600 [kg/m]	601 [kg/m]	R608 [kg/m]
600/601/608.20... <input type="text"/> .0	200	252	≈ 8,75	≈ 7,99	**
600/601/608.25... <input type="text"/> .0	250	302	≈ 9,11	≈ 8,17	**
600/601/608.30... <input type="text"/> .0	300	352	≈ 9,45	≈ 8,34	**
600/601.32... <input type="text"/> .0	320	372	≈ 9,59	≈ 8,41	-
600/601/608.35... <input type="text"/> .0	350	402	≈ 9,74	≈ 8,48	**
600/601/608.40... <input type="text"/> .0	400	452	≈ 10,19	≈ 8,71	**
600/601.45... <input type="text"/> .0	450	502	≈ 10,32	≈ 8,77	-
600/601.50... <input type="text"/> .0	500	552	≈ 10,63	≈ 8,93	-
600/601.55... <input type="text"/> .0	550	602	≈ 10,98	≈ 9,10	-
600/601.60... <input type="text"/> .0	600	652	≈ 11,47	≈ 9,35	-

Available bending radii

R [mm]

Supplement Part No. with required radius. Example: 600.30..0

0 = standard color, other colors ▶ page 1.39 · Pitch = 143 mm/link - Links/m = 7

\*not available for R608 \*\*upon request

System E4/00  
Inner height: 108 mm

Phone +49- (0) 22 03-96 49-800  
Fax +49- (0) 22 03-96 49-222

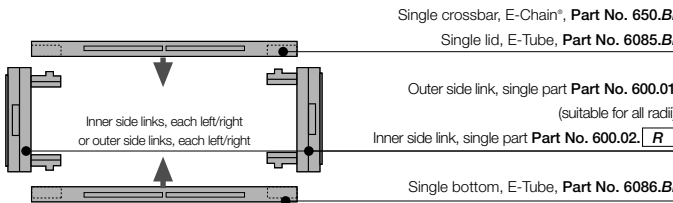

Part No. E-Chain® links, single parts

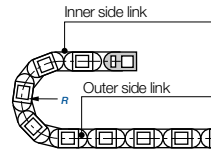

igus® E-Chains® in use on construction equipment under heavily soiled, adverse conditions



▶ page 7.11

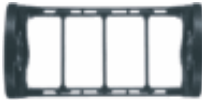

**Option 1**

- Vertical separators
- Spacers
- Locking separators

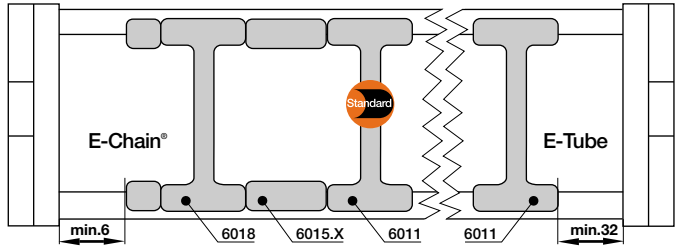

Vertical separator  
6001



Spacer  
6005.10



Spacer  
6005.15



Spacer  
6005.20



Locking separator  
6008

**Vertical separator  
for E-Chains®/E-Tubes**

unassembled	6001
assembled	6011



**Spacer\*,  
for E-Chains®**

unassembled	6005.10
assembled	6015.10



**Spacer\*,  
for E-Chains®**

unassembled	6005.15
assembled	6015.15



**Spacer\*,  
for E-Chains®**

unassembled	6005.20
assembled	6015.20



**Locking separator  
for E-Chains®**

unassembled	6008
assembled	6018



\*For side-mounted applications

**Option 1: Vertical separators and spacers**

Vertical separators are used if a vertical subdivision of the E-Chain® interior is required - By standard vertical separators are assembled every other E-Chain® link. **Note:** Observe a lateral spacing of at least 32 mm (E-Tube) and for the E-Chain® 6 mm! (Exception: No minimum spacing is needed for side plates. Minimum spacing Locking separator 6008 = 23 mm)

● **Standard separator 6001 for E-Chains® and E-Tubes** offers safe stability due to its wide base design, also when used with thick cables or hoses.

● Vertical separators in side-mounted applications, for instance, can be fixed in position by means of **spacer 6005.X for E-Chains®**. A wide range of intervals between the vertical separators is adjustable here.

● **Note on spacers:** The available interior height is reduced by 2 mm per spacer (4 mm when spacers are fitted on both sides). To avoid this, the parts can also be installed from the outside on the opening crossbar.

**Additionally:**

● **Locking separator 6008 for E-Chains®** - with increased retention force for applications exposed to very high humidity or extreme loads. The extra retention force is achieved by asymmetric claws for the crossbar. Ensure proper alignment.

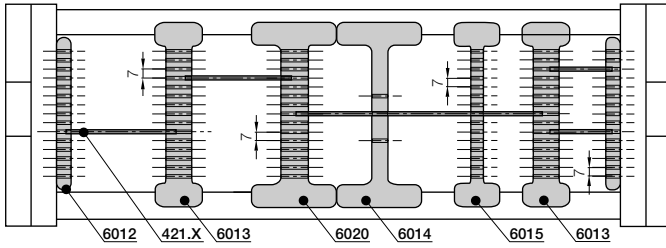

**Option 2**

- Side plates
- Middle plates
- Locking vertical separator
- Slotted separators
- Open slotted separators

**Option 2: Shelves**

For applications involving many cables with different diameters. The shelves can be arranged elevator-shifted with different bottoms.

● Side plates 6002, middle plates 6003 and shelves 420.X form the basic pattern of a shelf system. Shelves of various widths can be arranged at 15 different heights (in 7 mm increments).

● Locking vertical separator 6010 combined with shelves. Triple slots.

● Slotted separators 6004 are used for very fine subdivisions. However, they cannot be retrofitted into an existing separation system without dismantling the interior separators first.

● The unilateral open slotted separator 6005 can be retrofitted into an existing interior separation system without a need for dismantling the interior separators. During an installation of open slotted separators, the top and bottom notches cannot be occupied by shelves.

	<b>Side plate for E-Chains®/E-Tubes</b>	
	unassembled	6002
	assembled	6012

	<b>Middle plate for E-Chains®/E-Tubes</b>	
	unassembled	6003
	assembled	6013

	<b>Locking vertical separator for E-Chains®/E-Tubes</b>	
	unassembled	6010
	assembled	6020

	<b>Slotted separator for E-Chains®/E-Tubes</b>	
	unassembled	6004
	assembled	6014

	<b>Open slotted separator for E-Chains®/E-Tubes</b>	
	unassembled	6005
	assembled	6015



Side plate  
6002



Middle plate  
6003

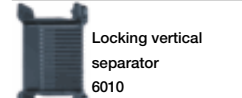

Locking vertical separator  
6010

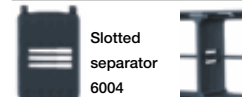

Slotted separator  
6004

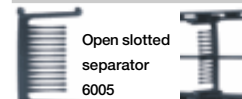

Open slotted separator  
6005



Shelf 420.X

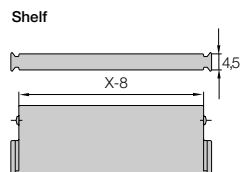

Shelf

Width X [mm]	Part No. unassembled	Part No. assembled
18	420.18	421.18
23	420.23	421.23
25	420.25	421.25
28	420.28	421.28
33	420.33	421.33
43	420.43	421.43
50	420.50	421.50
62	420.62	421.62

Width X [mm]	Part No. unassembled	Part No. assembled
75	420.75	421.75
100	420.100	421.100
125	420.125	421.125
150	420.150	421.150
175	420.175	421.175
187	420.187	421.187
200	420.200	421.200

System E4/00

Inner height: 108 mm

Phone +49- (0) 22 03-96 49-800

Fax +49- (0) 22 03-96 49-222





**Option steel - pivoting**

- For pivoting connections
- One part (two-piece) for all chain widths
- Electrically conductive

Moving end  
6000.1

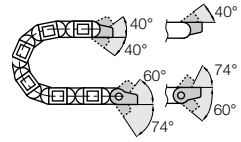

Fixed end  
6000.2

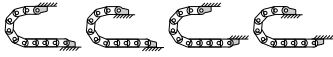

Possible installation conditions -  
Further installation angles ► installation sketch

**Dimensions and order configurations**

Moving end  
6000.1

Fixed end  
6000.2

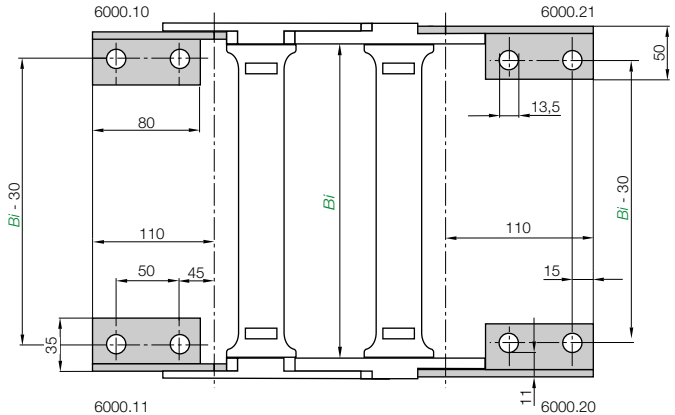

**Note mounting brackets:**

Depending on the E-Chain® length, the carrier will end with outer or inner side links. For the best appearance, make sure the chain ends with outer side link whenever possible. An odd number of links will always end with outer side links.

**Part No. Mounting bracket**

- 6000.1,12** Full attachment set (both sides) for E-Chain®, ending with outer side link
- 6000.3,12** Full attachment set (both sides) for E-Chain®, beginning with outer side link (moving end), ending with inner side link (fixed end)
- 6000.1** Mounting bracket set (one side) for outer side link
- 6000.2** Mounting bracket set (one side) for inner side link

Phone +49- (0) 22 03-96 49-800  
Fax +49- (0) 22 03-96 49-222

igus® GmbH  
51147 Cologne

System E4/00 | Series 600·601·R608 | Accessories | Strain Relief

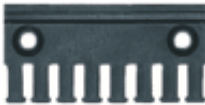

**Tie-wrap plate as individual part**

As individual component screwed on KMA. Can be plugged in the mounting brackets. **Details ► chapter 10**

Tie-wrap plate	No. of teeth	Dim. C [mm]	Dim. B [mm]	Center bore
3050.ZB	5	50	30	-
3075.ZB	7	75	55	-
3100.ZB	10	100	80	-
3115.ZB	11	115	95	-
3125.ZB	12	125	105	-
3150.ZB	15	150	130	-
3175.ZB	17	175	155	-
3200.ZB	20	200	180	+
3225.ZB	22	225	205	+
3250.ZB	25	250	230	+

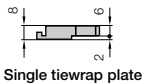

Single tie-wrap plate

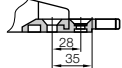

Shown assembled

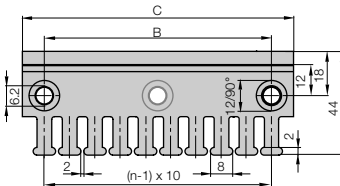

(- = no / + = yes)

Internet: [www.igus.de](http://www.igus.de)  
E-mail: [info@igus.de](mailto:info@igus.de)



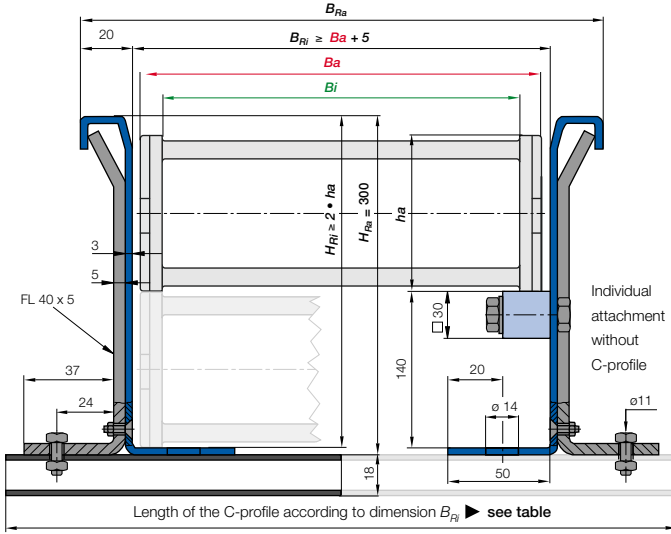

Guide troughs are used with applications where the upper run of the E-Chain® glides on the lower run. If using igus® steel guide troughs, the following components are required:

- **Guide trough without glide bars**  
Part No. 98.30
- **Guide trough with glide bars**  
Part No. 98.31
- **Installation sets as end connectors**  
Part No. 98.50.XX

.XX indicates the length of the C-profile on which the guide trough is mounted. The values and part numbers are specified in the table on the left. Standard length of the trough components and glide bars is 2 m. The required overall length of the guide trough directly correlates to the length of travel. Special dimensions are available for confined spaces.



Illustration top: Guide trough with and without glide bar. Illustration bottom: installation set

- $B_a$  = Outer width E-Chains® / E-Tube
- $B_i$  = Inner width E-Chains® / E-Tube
- $h_a$  = Outer height E-Chains® / E-Tube
- $H_{Ri}$  = Inner trough height
- $H_{Ra}$  = Outer trough height
- $B_{Ri}$  = Inner trough width ▶ depends on dim.  $B_a$
- $B_{Ra}$  = Outer trough width
- $n_{Mon}$  = Number of installation sets (left/right)
- $n_{Ri}$  = Number of trough sets (left/right)
- $H_{Ri} \geq 2 \cdot h_a$
- $B_{Ri} \geq B_a + 5$
- = Guide trough set
- = Installation set
- = Glide bar
- = C-profile

**Installation set with C-profile**

600.20.300.0 ▶ Order example

$B_{Ri}$	Part No.	Installation set
.20	257	98.50.375
.25	307	98.50.425
.30	357	98.50.475
.32	377	98.50.500
.35	407	98.50.525
.40	457	98.50.575
.45	507	98.50.625
.50	557	98.50.675
.55	607	98.50.725
.60	657	98.50.775

**Order example: Length of travel 30 m - Center mounted for Series 600.30.300.0 with  $B_{Ri} = 357$**

Guide trough set (set of 2 trough side parts, incl. glide strips) <b>without</b> glide bar	
Order text: 16 m Guide trough without glide bar (8 x 2 m sections)	<b>Part No. 98.30</b>
Guide trough set (set of 2 trough side parts, incl. glide strips) <b>with</b> glide bar	
Order text: 16 m Guide trough with glide bar (8 x 2 m sections)	<b>Part No. 98.31</b>
Installation set "Basic" complete (Guide trough-sets + 1)	
Order text: 17 Installation sets (with C-profile)	<b>Part No. 98.50.475</b>

Principle sketch: Number of installation sets to be installed = **Number of trough sections + 1**

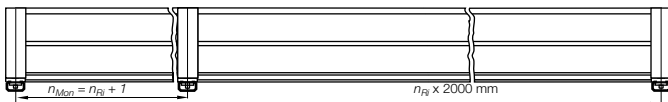

Phone +49- (0) 22 03-96 49-800  
 Fax +49- (0) 22 03-96 49-222

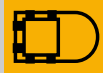



Price index



This E4 Series is a  
"Low-noise-Version"



Cleanroom test  
upon request



ESD classification:  
Electrically conductive ESD/ATEX  
version upon request



Opening E-Chains\*: Remove crossbars and clips - Insert screwdriver into the slot, push down, release by lever action. Repeat action for the other side



When to use the Series 640:

- If a low-noise version is required
- At very high speeds and/or accelerations
- For long travels
- For high additional loads



When not to use it:

- If a simple and low-cost solution is required
  - ▶ Series 1640, page 7.194
- If higher stability is required
  - ▶ Series 600/601/R608, page 7.56
- If an enclosed solution is required
  - ▶ Series R608, page 7.56

- 1 Optimum ratio of inner height to outer height
- 2 Numerous interior separation possibilities
- 3 Stop dog with "brake" for noise reduction
- 4 Wide, rounded plastic crossbars - cable friendly
- 5 Optimized glide pads with lateral wear allowance
- 6 Dirt-repellent exterior
- 7 E-Chains\* also available with reverse bending radius "RBR"
- 8 Crossbars are removable along both radii



Order example complete E-Chain®

Please indicate chain-lengths or number of links Example: 4 m or 28 links

4 m 640.33.300.0

E-Chain®

with 2 separators 6411 assembled every 2<sup>nd</sup> link Interior separation

1 set 6000.1.12

Mounting bracket

**Unsupported length**

$FL_G$  = with straight upper run

$FL_B$  = with permitted sag

Further information ► **Design, page 1.12**

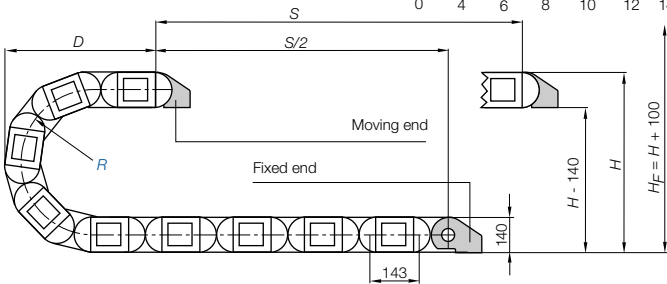
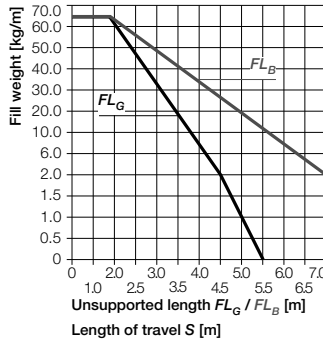
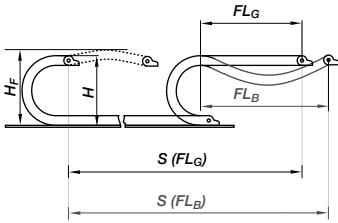

Pitch = 143 mm/link    Links/m = 7 (1001 mm)    Chain length =  $S/2 + K$

R	200	250	300	350	400	450	500	550	600	750	1000
H	545	645	745	845	945	1045	1145	1245	1345	1645	2145
D	415	465	515	565	615	665	715	765	815	965	1215
K	920	1080	1240	1400	1560	1720	1870	2020	2175	2660	3435
$D_2^{+25}$	800	900	1100	1200	1430	1580	1700	1850	2050	2850	-
$K_2$	1287	1430	1859	2145	2574	2860	3146	3432	3861	5005	-
$H_2$	325	325	325	325	325	325	325	325	325	325	-

- S = Length of travel
  - R = Bending radius
  - H = Nominal clearance height
  - $H_F$  = Required clearance height
  - $H_{in}$  = Trough inner height
  - D = Overlength E-Chain® radius in final position
  - $K = \pi \cdot R + \text{"safety"}$
  - $D_2$  = Over length - long travels, gliding
  - $K_2$  = "Further add-on"
  - $H_2$  = "Mounting height"
- \*if the mounting bracket location is set lower

**Other installation methods**

- Vertical, hanging  $\leq 120$  m
- Vertical, standing  $\leq 6$  m
- Side mounted, un supp.  $\leq 4$  m
- Rotary requires further calculation
- Unsupported length of upper run = upon request

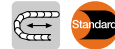

**Short travels - unsupported**

Unsupported E-Chains® feature positive camber over short travels. This must be accounted for when specifying the clearance height  $H_F$ . Please consult igus® if space is particularly restricted.

The required clearance height:  
 $H_F = H + 100$  mm  
(with 5,0 kg/m fill weight)

**Long travel lengths from 10 m to max. 450 m    Chain length =  $S/2 + K_2$**

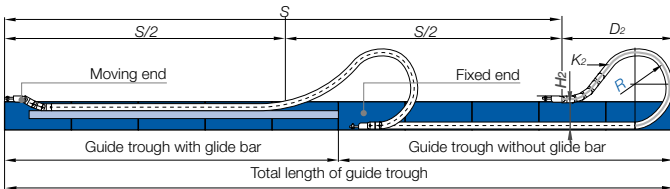

In case of travels between 4 and 10 m we recommend a longer unsupported length.



**Gliding, long travel applications (max. 450 m)**

In this case the E-Chain® upper run will be introduced in a guide trough on the lower run. We recommend to realize the engineering of such a plant by our technicians.

Speed / acceleration $FL_G$	max. 20 [m/s] / max. 200 [m/s²]
Speed / acceleration $FL_B$	max. 3 [m/s] / max. 6 [m/s²]
Gliding speed / acceleration (maximum)	max. 10 [m/s] / max. 50 [m/s²]
Material - permitted temperature °C	igumid G / -40° up to +120° C
Flammability class, igumid G	VDE 0304 IIC UL94 HB

**Technical Data**



Details of material properties  
► page 1.38

System E4/00  
Inner height: 112 mm

Phone +49- (0) 22 03-96 49-800  
Fax +49- (0) 22 03-96 49-222



► page 7.11

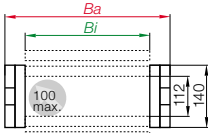

Part No. structure

640. 33. 300. 0



Series 640 - E-Chain® with crossbars every link

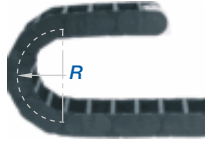

- Crossbars every link
- For rigid hydraulic hoses
- For applications particularly demanding
- Can be opened from two sides



Phone +49- (0) 22 03-96 49-800  
Fax +49- (0) 22 03-96 49-222

igus® GmbH  
51147 Cologne

Long travels with guide troughs - System E4/00 harnessed with hydraulic-hoses and Chainflex® cables



Internet: [www.igus.de](http://www.igus.de)  
E-mail: [info@igus.de](mailto:info@igus.de)

Part No.	<i>Bi</i> [mm]	<i>Ba</i> [mm]	Weight [kg/m]
640.12. <input type="text"/> .0	87	139	≈ 7,57
640.13. <input type="text"/> .0	99	152	≈ 7,66
640.15. <input type="text"/> .0	112	164	≈ 7,70
640.16. <input type="text"/> .0	124	177	≈ 7,77
640.17. <input type="text"/> .0	137	189	≈ 7,84
640.18. <input type="text"/> .0	149	202	≈ 7,91
640.20. <input type="text"/> .0	162	214	≈ 7,92
640.21. <input type="text"/> .0	174	227	≈ 7,99
640.22. <input type="text"/> .0	187	239	≈ 8,04
640.23. <input type="text"/> .0	199	252	≈ 8,12
640.25. <input type="text"/> .0	212	264	≈ 8,18
640.26. <input type="text"/> .0	224	277	≈ 8,23
640.27. <input type="text"/> .0	237	289	≈ 8,30
640.28. <input type="text"/> .0	249	302	≈ 8,32
640.30. <input type="text"/> .0	262	314	≈ 8,39
640.31. <input type="text"/> .0	274	327	≈ 8,46
640.32. <input type="text"/> .0	287	339	≈ 8,51
640.33. <input type="text"/> .0	300	352	≈ 8,62
640.35. <input type="text"/> .0	312	364	≈ 8,68
640.36. <input type="text"/> .0	324	377	≈ 8,72
640.37. <input type="text"/> .0	337	389	≈ 8,74
640.38. <input type="text"/> .0	349	402	≈ 8,79
640.40. <input type="text"/> .0	362	414	≈ 8,92
640.41. <input type="text"/> .0	374	427	≈ 9,02
640.42. <input type="text"/> .0	387	439	≈ 9,11
640.43. <input type="text"/> .0	399	452	≈ 9,16
640.45. <input type="text"/> .0	412	464	≈ 9,20
640.46. <input type="text"/> .0	424	477	≈ 9,21
640.47. <input type="text"/> .0	437	489	≈ 9,26
640.48. <input type="text"/> .0	449	502	≈ 9,30
640.50. <input type="text"/> .0	462	514	≈ 9,38
640.51. <input type="text"/> .0	474	527	≈ 9,39
640.52. <input type="text"/> .0	487	539	≈ 9,42
640.53. <input type="text"/> .0	499	552	≈ 9,52
640.55. <input type="text"/> .0	512	564	≈ 9,83
640.60. <input type="text"/> .0	562	614	≈ 9,95

Available bending radii

R [mm]

Supplement Part No. with required radius. Example: 640.33..0

0 = standard color, other colors ▶ page 1.39 · Pitch = 143 mm/link - Links/m = 7

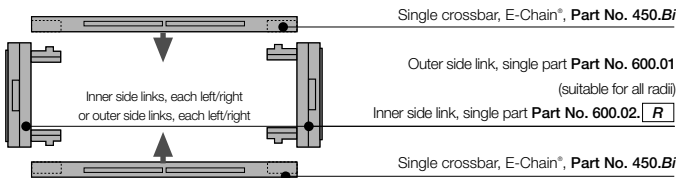

Part No. E-Chain® links, single parts

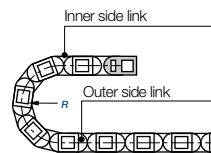

System E4/00  
Inner height: 112 mm

Phone +49- (0) 22 03-96 49-800  
Fax +49- (0) 22 03-96 49-222



▶ page 7.11

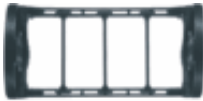

Option 1

- Vertical separators
- Spacers
- Locking separators

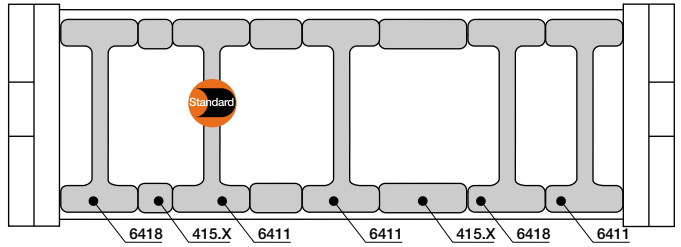

Vertical separator  
6401



Spacer  
405.10



Spacer  
405.15



Spacer  
405.20



Spacer  
405.30



Spacer  
405.40



Locking separator  
6408

Vertical separator for E-Chains®	
unassembled	6401
assembled	6411



Spacer* for E-Chains®	
unassembled	405.10
assembled	415.10



Spacer* for E-Chains®	
unassembled	405.15
assembled	415.15



Spacer* for E-Chains®	
unassembled	405.20
assembled	415.20



Spacer* for E-Chains®	
unassembled	405.30
assembled	415.30



Spacer* for E-Chains®	
unassembled	405.40
assembled	415.40



Locking separator for E-Chains®	
unassembled	6408
assembled	6418



\*For side-mounted applications

Option 1: Vertical separators and spacers

Vertical separators are used if a vertical subdivision of the E-Chain® interior is required - By standard vertical separators are assembled every other E-Chain® link.

● Standard separator 6401 for E-Chains® offers safe stability due to its wide base design, also when used with thick cables or hoses.

● Vertical separators in side-mounted applications, for instance, can be fixed in position by means of spacer 405.X for E-Chains®. A wide range of intervals between the vertical separators is adjustable here.

● Note on spacers: The available interior height is reduced by 2 mm per spacer (4 mm when spacers are fitted on both sides). To avoid this, the parts can also be installed on the outside on the opening crossbar.

Additionally:

● The Locking separator for E-Chains® 6408 is designed for applications exposed to extremely high humidity, for example, at composting plants. The lateral cam serves for uniform alignment of the vertical separators; if these separators are misaligned, they will inevitably get damaged on an attempt to open the E-Chain®.

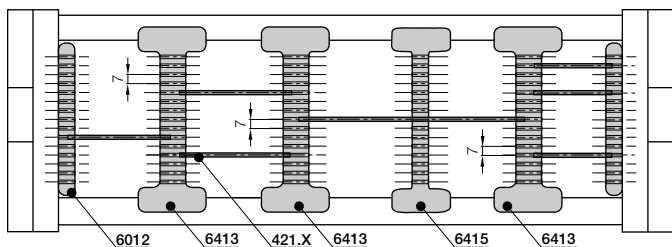

**Option 2**

- Side plates
- Middle plates
- Open slotted separators

**Option 2: Shelves**

For applications involving many cables with different diameters. The shelves can be arranged elevator-shifted with different bottoms.

● Side plates 6002, middle plates 6403 and shelves 420.X form the basic pattern of a shelf system. Shelves of various widths can be arranged at 15 different heights (in 7 mm increments).

● The unilateral open slotted separator 6405 can be retrofitted into an existing interior separation system without a need for dismantling the interior separators. During an installation of open slotted separators, the top and bottom notches cannot be occupied by shelves.

	Side plate for E-Chains®	
	unassembled	6002
	assembled	6012

	Middle plate for E-Chains®	
	unassembled	6403
	assembled	6413

	Open slotted separator for E-Chains®	
	unassembled	6405
	assembled	6415



Side plate  
6002



Middle plate  
6403

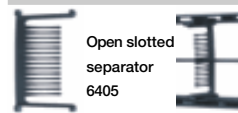

Open slotted separator  
6405

Width X [mm]	Part No. unassembled	Part No. assembled
18	420.18	421.18
23	420.23	421.23
25	420.25	421.25
28	420.28	421.28
33	420.33	421.33
43	420.43	421.43
50	420.50	421.50
62	420.62	421.62

Width X [mm]	Part No. unassembled	Part No. assembled
75	420.75	421.75
100	420.100	421.100
125	420.125	421.125
150	420.150	421.150
175	420.175	421.175
187	420.187	421.187
200	420.200	421.200



Shelf 420.X

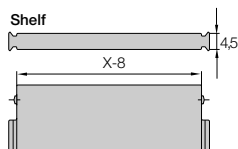

**Additional elements for interior separation**

	Rollclip	
	unassembled	489.27
	assembled	490.27

**Rollclip** - minimizes abrasion of particularly sensitive hoses. The Rollclip is simply clamped onto the opening crossbar. The movable rollers compensate for relative movement between the chain and hose.



System E4/00  
Inner height: 112 mm

Phone +49- (0) 22 03-96 49-800  
Fax +49- (0) 22 03-96 49-222







Consult igus® for your extender crossbar applications. We are happy to assist you with your design layout

### Extender crossbars - careful guide of hoses applications

- Suitable for hoses with a maximum outer diameter of 300 mm
- Gliding operation with crossbars assembled along the outer radius and a special guide trough
- Gliding operation not guaranteed with crossbars assembled along the inner radius
- The extender crossbar can either be attached to the side links directly or can be used in combination with two stranded snap-open crossbars

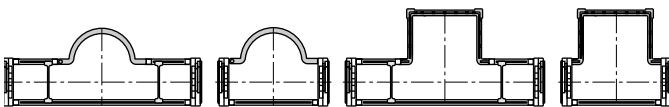

Round extender crossbar with snap-open crossbars

Attached directly to the side link

Square extender crossbar with snap-open crossbars

Attached directly to the side link

Part No.	Max Ø [mm] hose	Form	Installation side link	Combination with snap-open crossb.
450.15.RHD115	115	○	-	+
450.17.RD115	115	○	+	-
450.25.D150	150	□	+	-
450.30.D200	200	□	+	-
450.35.D250	250	□	+	-
450.40.D300	300	□	+	-
450.20.HD150	150	□	-	+
450.25.HD200	200	□	-	+
450.30.HD250	250	□	-	+

○ = round □ = square + = yes / - = no



### E4 clip-on cable binder

- For side-mounted applications
- Serves as a clip-on, lateral guide for hoses and cables on E-Chains®
- The loops can be adjusted as required
- Compatible with many E4 E-Chains®
- Stylish and economical
- One clip and one locking band are needed for each chain link
- Call us if you have any questions on project planning

Part No.	Form
450.B12	Locking clip, comprising a locking element
450.B12.200	Locking band, comprising a locking element and band; 12 x 1,5 x 200 mm



**Option steel - pivoting**

- For pivoting connections
- One part (two-piece) for all chain widths
- Electrically conductive

Moving end  
6000.1

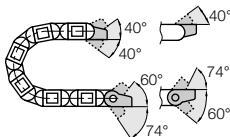

Fixed end  
6000.2

Possible installation conditions -  
Further installation angles ► installation sketch

Moving end  
6000.1

Fixed end  
6000.2

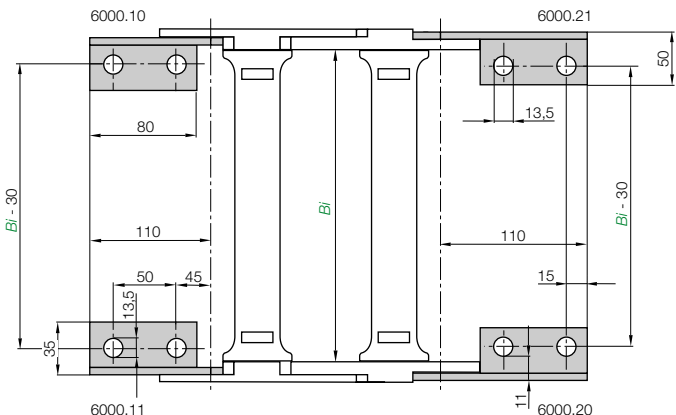

**Dimensions and order configurations**

Part No.	Mounting bracket
6000.1.12	Full attachment set (both sides) for E-Chain®, ending with outer side link
6000.3.12	Full attachment set (both sides) for E-Chain®, beginning with outer side link (moving end), ending with inner side link (fixed end)
6000.1	Mounting bracket set (one side) for outer side link
6000.2	Mounting bracket set (one side) for inner side link

**Note mounting brackets:**

Depending on the E-Chain® length, the carrier will end with outer or inner side links. For the best appearance, make sure the chain ends with outer side link whenever possible. An odd number of links will always end with outer side links.

**System E4/00 | Series 640 | Accessories | Strain Relief**

Tiewrap plate	No. of teeth n	Dim. C [mm]	Dim. B [mm]	Center bore
3050.ZB	5	50	30	-
3075.ZB	7	75	55	-
3100.ZB	10	100	80	-
3115.ZB	11	115	95	-
3125.ZB	12	125	105	-
3150.ZB	15	150	130	-
3175.ZB	17	175	155	-
3200.ZB	20	200	180	+
3225.ZB	22	225	205	+
3250.ZB	25	250	230	+

**Tiewrap plate as individual part**

As individual component screwed on KMA. Can be plugged in the mounting brackets. **Details ► chapter 10**

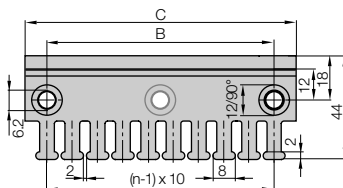

Single tiewrap plate

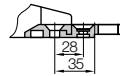

Shown assembled



► chapter 10



► page 7.11

- Ba** = Outer width E-Chains® / E-Tube
- Bi** = Inner width E-Chains® / E-Tube
- ha** = Outer height E-Chains® / E-Tube
- H<sub>Ri</sub>** = Inner trough height
- H<sub>Ra</sub>** = Outer trough height
- B<sub>Ri</sub>** = Inner trough width ▶ depends on dim. Ba
- B<sub>Ra</sub>** = Outer trough width
- n<sub>Mon</sub>** = Number of installation sets (left/right)
- n<sub>Ri</sub>** = Number of trough sets (left/right)
- ▶ **H<sub>Ri</sub> ≥ 2 • ha**
- ▶ **B<sub>Ri</sub> ≥ Ba + 5**

- = Guide trough set
- = Installation set
- = Glide bar
- = C-profile

**Installation set with C-profile**

640.12.300.0 ▶ Order example

<b>B<sub>Ri</sub></b>	<b>Part No.</b>	<b>Installation set</b>
.12	144	98.50.275
.13	157	98.50.275
.15	169	98.50.300
.16	182	98.50.300
.17	194	98.50.325
.18	207	98.50.325
.20	219	98.50.350
.21	232	98.50.350
.22	244	98.50.375
.23	257	98.50.375
.25	269	98.50.400
.26	282	98.50.400
.27	294	98.50.425
.28	307	98.50.425
.30	319	98.50.450
.31	332	98.50.450
.32	344	98.50.475
.33	357	98.50.475
.35	369	98.50.500
.36	382	98.50.500
.37	394	98.50.525
.38	407	98.50.525
.40	419	98.50.550
.41	432	98.50.550
.42	444	98.50.575
.43	457	98.50.575
.45	469	98.50.600
.46	482	98.50.600
.47	494	98.50.625
.48	507	98.50.625
.50	519	98.50.650
.51	532	98.50.650
.52	544	98.50.675
.53	557	98.50.675
.55	569	98.50.700
.60	619	98.50.750

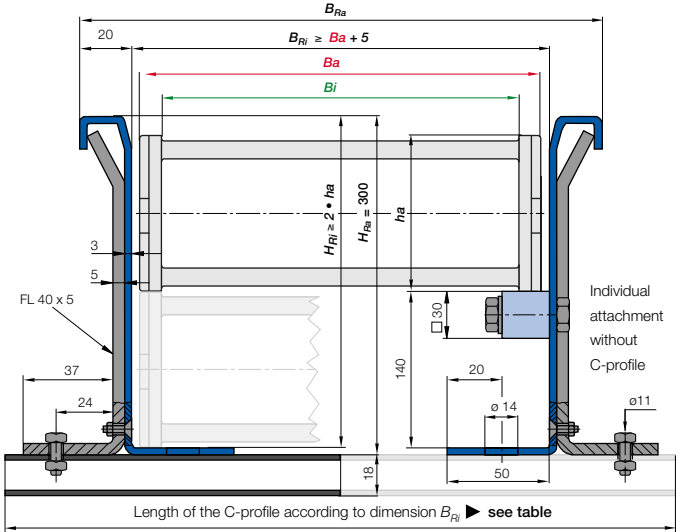

Guide troughs are used with applications where the upper run of the E-Chain® glides on the lower run. If using igus® steel guide troughs, the following components are required:

- **Guide trough without glide bars**  
Part No. 98.30
- **Guide trough with glide bars**  
Part No. 98.31
- **Installation sets as end connectors**  
Part No. 98.50.XX

.XX indicates the length of the C-profile on which the guide trough is mounted. The values and part numbers are specified in the table on the left. Standard length of the trough components and glide bars is 2 m. The required overall length of the guide trough directly correlates to the length of travel. Special dimensions are available for confined spaces.

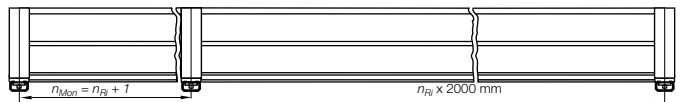

Illustration top: Guide trough with and without glide bar. Illustration bottom: installation set

**Order example: Length of travel 30 m - Center mounted for Series 640.33.300.0 with B<sub>Ri</sub> = 357**

Guide trough set (set of 2 trough side parts, incl. glide strips) <b>without</b> glide bar	
<b>Order text:</b> 16 m Guide trough without glide bar (8 x 2 m sections)	<b>Part No. 98.30</b>
Guide trough set (set of 2 trough side parts, incl. glide strips) <b>with</b> glide bar	
<b>Order text:</b> 16 m Guide trough with glide bar (8 x 2 m sections)	<b>Part No. 98.31</b>
Installation set "Basic" complete (Guide trough-sets + 1)	
<b>Order text:</b> 17 Installation sets (with C-profile)	<b>Part No. 98.50.475</b>

Principle sketch: Number of installation sets to be installed = **Number of trough sections + 1**



Phone +49- (0) 22 03-96 49-800  
Fax +49- (0) 22 03-96 49-222

igus® GmbH  
51147 Cologne

Internet: www.igus.de  
E-mail: info@igus.de

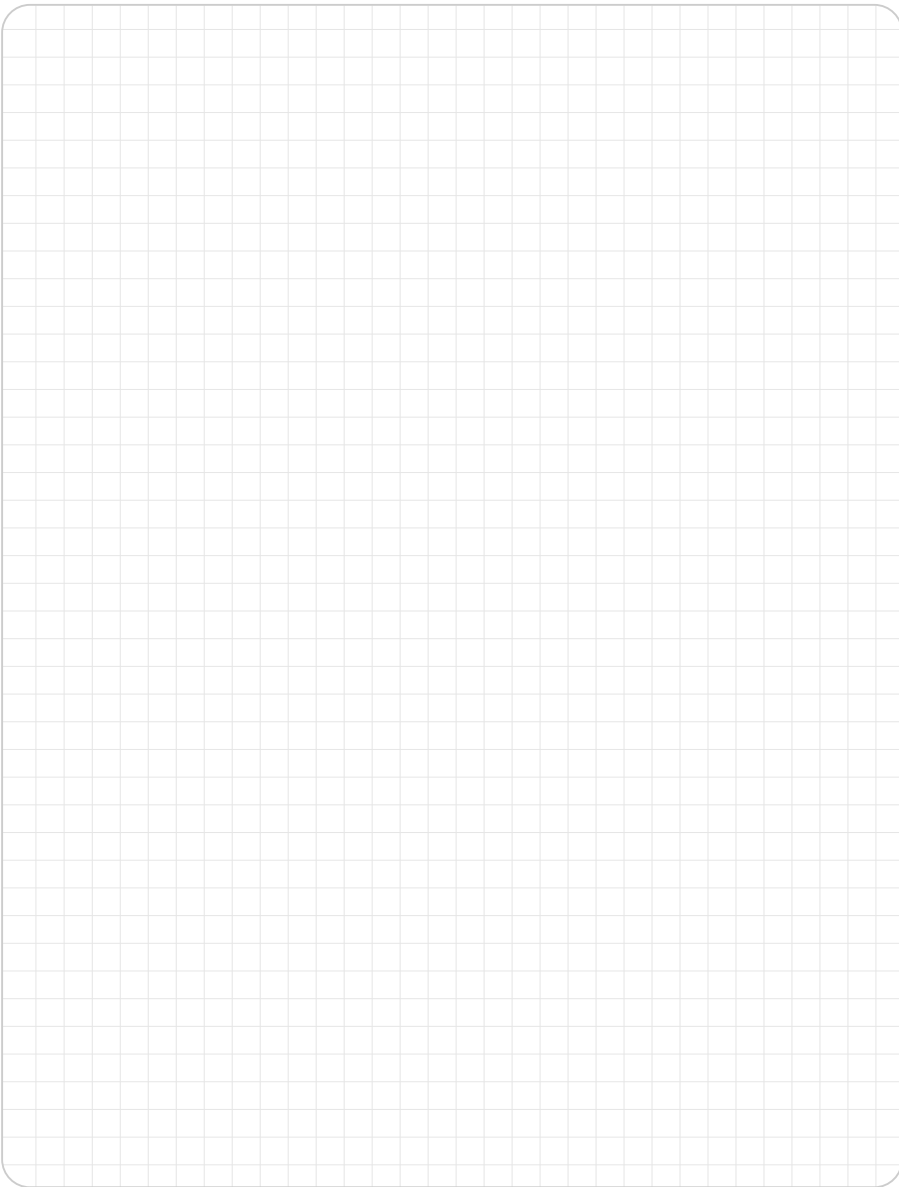

System E4/00

Inner height: 112 mm

Phone +49- (0) 22 03-96 49-800

Fax +49- (0) 22 03-96 49-222



chapter 9



page 7.11

# Single-wire for high performance. Up to 185 mm<sup>2</sup> cross-section - Chainflex® CF310.UL

TIP!

TPE-outer jacket, flame retardant, oil and bio-oil-resistant, shielded  
Further information: [www.igus.de/en/CF310](http://www.igus.de/en/CF310)

CHAINFLEX® CF310.UL





Price index



This E4 Series is a  
"Low-noise-Version"



Cleanroom test  
upon request



ESD classification:  
Electrically conductive ESD/ATEX  
version upon request



Opening E-Chains®: Remove crossbars and clips - Insert screwdriver into the slot, push down, release by lever action. Repeat action for the other side



You can find an assembly video on the  
web ► [www.igus.de/en/800\\_assembly](http://www.igus.de/en/800_assembly)



When to use the Series 800:

- If a particularly big and stable E-Chain® is required
- At very high speeds and/or accelerations
- For long travels
- For high additional loads



When not to use it:

- If a lighter, less stable E-Chain® with identical inner height is required  
► Series 840, page 7.80

- 1 Each chain link is made more rigid due to four opening crossbars, and consequently provides a great unsupported length
- 2 Crossbars are removable along both radii
- 3 Stop dog with "brake" for noise reduction
- 4 Optimized glide pads with lateral wear allowance
- 5 Wide, rounded plastic crossbars - cable friendly
- 6 The biggest igus® polymer E-Chain®
- 7 Dirt-repellent exterior
- 8 E-Chains® also available with reverse bending radius "RBR"
- 9 Tongue and groove for more stability

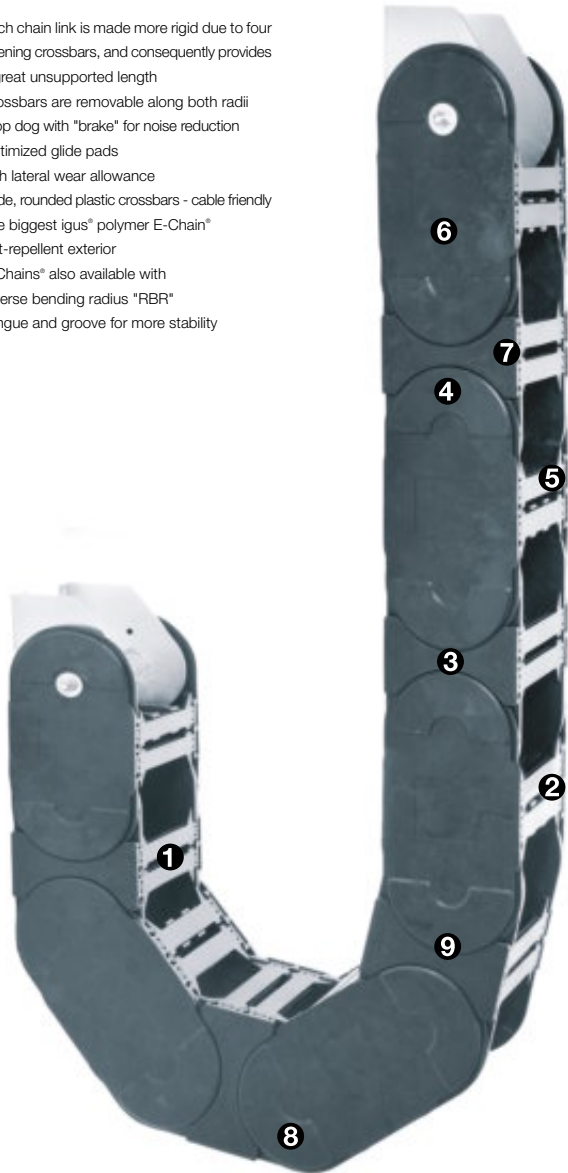

Order example complete E-Chain®

Please indicate chain-lengths or number of links Example: 5 m or 20 links

5 m 800.30.350.0

E-Chain®

with 2 separators 8011 assembled every 2<sup>nd</sup> link

Interior separation

1 set 8000.1.12

Mounting bracket

**Unsupported length**

$FL_G$  = with straight upper run

$FL_B$  = with permitted sag

Further information ► **Design, page 1.12**

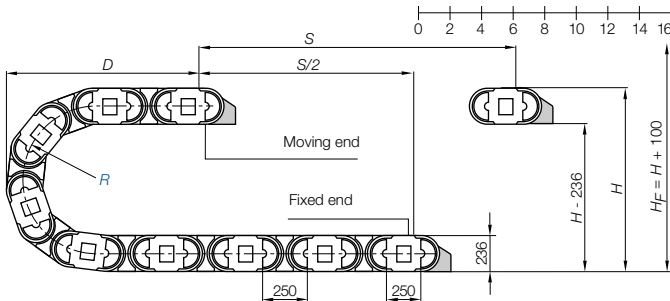
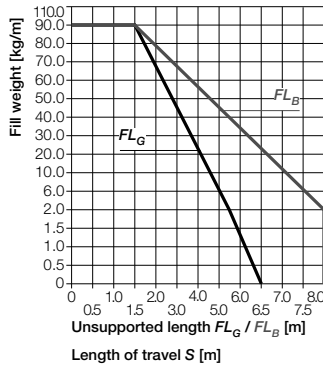
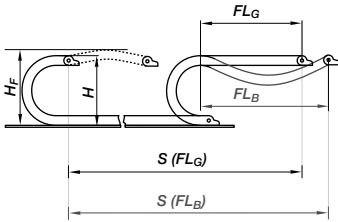

Pitch = 250 mm/link    Links/m = 4 (1000 mm)    Chain length =  $S/2 + K$

R	325	350	400	450	500	600	750	1000
H	886	936	1036	1136	1236	1436	1736	2236
D	725	750	800	850	900	1000	1150	1400
K	1525	1600	1760	1915	2075	2385	2860	3645
$D_2^{+25}$	*	*	*	*	*	*	*	*
$K_2$	*	*	*	*	*	*	*	*
$H_2$	*	*	*	*	*	*	*	*

\*upon request

- S = Length of travel
- R = Bending radius
- H = Nominal clearance height
- $H_F$  = Required clearance height
- $H_{in}$  = Trough inner height
- D = Overlength E-Chain® radius in final position
- $K = \pi \cdot R + \text{"safety"}$
- $D_2$  = Over length - long travels, gliding
- $K_2$  = "Further add-on"
- $H_2$  = "Mounting height"

**Other installation methods**

- Vertical, hanging  $\leq 120$  m
- Vertical, standing  $\leq 6$  m
- Side mounted, unupp.  $\leq 6$  m
- Rotary requires further calculation
- Unsupported length of upper run = upon request

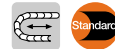

**Short travels - unsupported**

Unsupported E-Chains® feature positive camber over short travels. This must be accounted for when specifying the clearance height  $H_F$ . Please consult igus® if space is particularly restricted.

The required clearance height:  
 $H_F = H + 100$  mm  
(with 5,0 kg/m fill weight)

**Long travel lengths from 10 m to max. 450 m    Chain length =  $S/2 + K_2$**

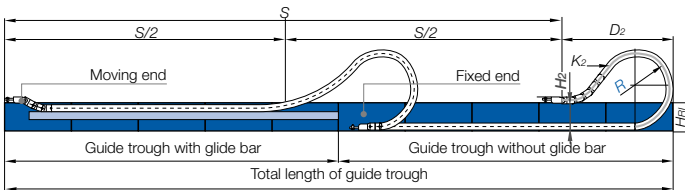

In case of travels between 4 and 10 m we recommend a longer unsupported length.



**Gliding, long travel applications (max. 450 m)**

In this case the E-Chain® upper run will be introduced in a guide trough on the lower run. We recommend to realize the engineering of such a plant by our technicians.

Speed / acceleration $FL_G$	max. 20 [m/s] / max. 200 [m/s²]
Speed / acceleration $FL_B$	max. 3 [m/s] / max. 6 [m/s²]
Gliding speed / acceleration (maximum)	max. 10 [m/s] / max. 50 [m/s²]
Material - permitted temperature °C	igumid G / -40° up to +120° C
Flammability class, igumid G	VDE 0304 IIC UL94 HB

**Technical Data**



Details of material properties  
► page 1.38

System E4/00  
Inner height: 200 mm

Phone +49- (0) 22 03-96 49-800  
Fax +49- (0) 22 03-96 49-222



► page 7.11

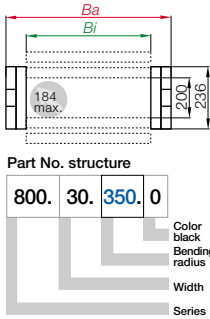

Series 800 - E-Chain® with crossbars every link

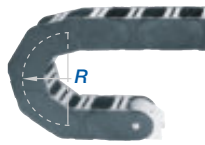

- E-Chains® of this size are basically used with crossbars every link
- Robust version
- Can be opened from two sides
- Removable crossbars



Part No.	<i>Bi</i> [mm]	<i>Ba</i> [mm]	Weight [kg/m]
800.20. <input type="text"/> .0	200	260	≈ 15,09
800.25. <input type="text"/> .0	250	310	≈ 15,50
800.30. <input type="text"/> .0	300	360	≈ 15,89
800.32. <input type="text"/> .0	325	385	≈ 16,05
800.35. <input type="text"/> .0	350	410	≈ 16,22
800.40. <input type="text"/> .0	400	460	≈ 16,74
800.45. <input type="text"/> .0	450	510	≈ 16,88
800.50. <input type="text"/> .0	500	560	≈ 17,23
800.55. <input type="text"/> .0	550	610	≈ 17,63
800.60. <input type="text"/> .0	600	660	≈ 18,19

Available bending radii

R [mm]

Supplement Part No. with required radius. Example: 800.30..0

0 = standard color, other colors ▶ page 1.39 · Pitch = 250 mm/link - Links/m = 4

Phone +49- (0) 22 03-96 49-800  
Fax +49- (0) 22 03-96 49-222

igus® GmbH  
51147 Cologne

Part No. E-Chain® links, single parts

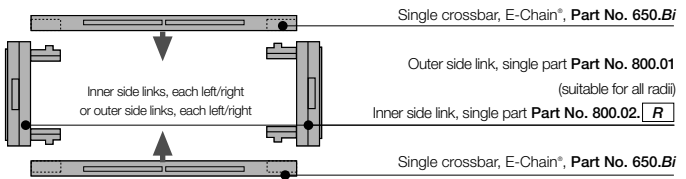
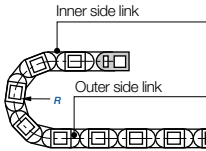

Internet: [www.igus.de](http://www.igus.de)  
E-mail: [info@igus.de](mailto:info@igus.de)

Assembling of an E4/00  
E-Chain® Series 800 in  
an igus® steel-guidetrough





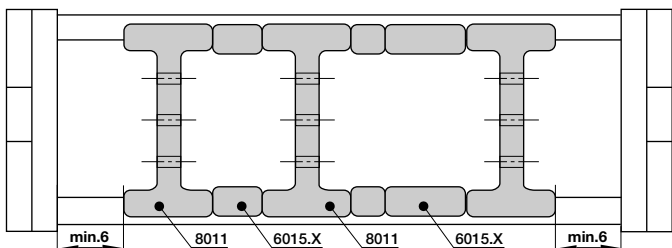

**Option 1**

- Vertical separators
- Spacers

**Option 1: Vertical separators and spacers**

Vertical separators are used if a vertical subdivision of the E-Chain® interior is required - By standard vertical separators are assembled every other E-Chain® link. **Note:** Observe a lateral spacing of at least 6 mm!

● **Standard separator 8001 for E-Chains®** offers safe stability due to its wide base design, also when used with thick cables or hoses.

● Vertical separators in side-mounted applications, for instance, can be fixed in position by means of **spacer 6005.X for E-Chains®**. A wide range of intervals between the vertical separators is adjustable here.

● **Note on spacers:** The available interior height is reduced by 2 mm per spacer (4 mm when spacers are fitted on both sides). To avoid this, the parts can also be installed from the outside on the opening crossbar.



<b>Vertical separator for E-Chains®</b>	
unassembled	8001
assembled	8011

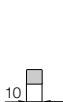

<b>Spacer* for E-Chains®</b>	
unassembled	6005.10
assembled	6015.10



<b>Spacer* for E-Chains®</b>	
unassembled	6005.15
assembled	6015.15



<b>Spacer* for E-Chains®</b>	
unassembled	6005.20
assembled	6015.20

\*For side-mounted applications



Vertical separator 8001



Spacer 6005.10



Spacer 6005.15



Spacer 6005.20

System E4/00  
Inner height: 200 mm

Phone +49- (0) 22 03-96 49-800  
Fax +49- (0) 22 03-96 49-222



▶ page 7.11

**Modular E4 shelving system safeguides large cables - Series 800**

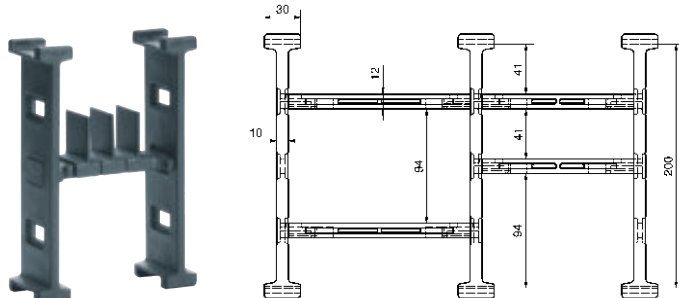

Part No. unassembled	Part No. assembled	Snap in tab	Part No. separator	Part No. crossbar	Width [mm]
8001H1	8011H1	single-sided	8001	450.XX	50-600
8001H2	8011H2	double-sided	8001	450.XX	50-600

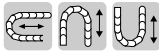

**Option steel - pivoting**

- For pivoting connections
- One part (two-piece) for all chain widths
- Electrically conductive

Moving end  
8000.1

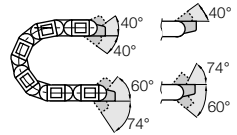

Fixed end  
8000.2

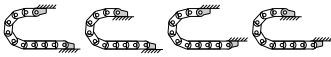

Possible installation conditions -  
Further installation angles ► installation sketch

Phone +49- (0) 22 03-96 49-800  
Fax +49- (0) 22 03-96 49-222

igus® GmbH  
51147 Cologne

Moving end  
8000.1

Fixed end  
8000.2

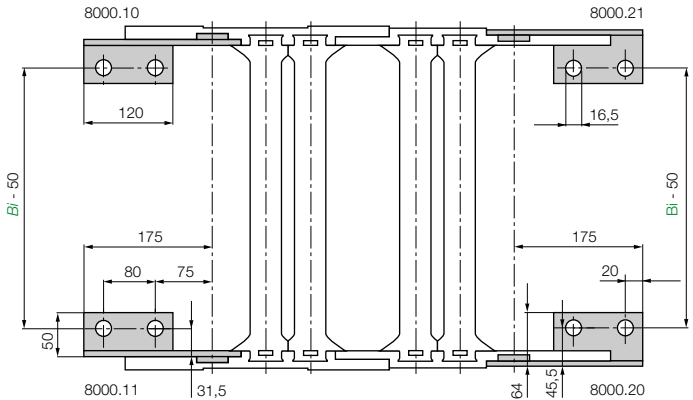

**Note mounting brackets:**  
Depending on the E-Chain® length, the carrier will end with outer or inner side links. For the best appearance, make sure the chain ends with outer side link whenever possible. An odd number of links will always end with outer side links.

**Part No. Mounting bracket**

- 8000.1,12** Full attachment set (both sides) for E-Chain®, ending with outer side link
- 8000.3,13** Full attachment set (both sides) for E-Chain®, beginning with outer side link (moving end), ending with inner side link (fixed end)
- 8000.1** Mounting bracket set (one side) for outer side link
- 8000.2** Mounting bracket set (one side) for inner side link

System E4/00 | Series 800 | Accessories | Strain Relief

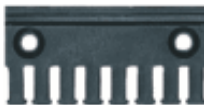

**Tiewrap plate as individual part**

As individual component screwed on KMA. Can be plugged in the mounting brackets. **Details ► chapter 10**

Tiewrap plate	No. of teeth	Dim. C [mm]	Dim. B [mm]	Center bore
3050.ZB	5	50	30	-
3075.ZB	7	75	55	-
3100.ZB	10	100	80	-
3115.ZB	11	115	95	-
3125.ZB	12	125	105	-
3150.ZB	15	150	130	-
3175.ZB	17	175	155	-
3200.ZB	20	200	180	+
3225.ZB	22	225	205	+
3250.ZB	25	250	230	+

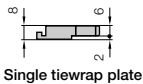

Single tie-wrap plate

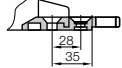

Shown assembled

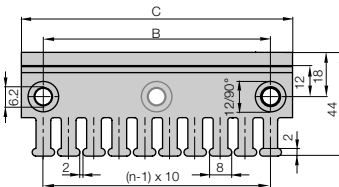

Internet: [www.igus.de](http://www.igus.de)  
E-mail: [info@igus.de](mailto:info@igus.de)





Price index



This E4 Series is a  
"Low-noise-Version"



Cleanroom test  
upon request



ESD classification:  
Electrically conductive ESD/ATEX  
version upon request



Opening E-Chains®: Remove crossbars and clips - Insert screwdriver into the slot, push down, release by lever action. Repeat action for the other side



You can find an assembly video on the  
web ► [www.igus.de/en/800\\_assembly](http://www.igus.de/en/800_assembly)



When to use the Series 840:

- If a particularly big and stable E-Chain® is required
- At very high speeds and/or accelerations
- For long travels
- For high additional loads



When not to use it:

- If a more stable E-Chain® with identical inner height is required  
► Series 800, page 7.74

- 1 Each chain link is made more rigid due to four opening crossbars, and consequently provides a great unsupported length
- 2 Crossbars are removable along both radii
- 3 Stop dog with "brake" for noise reduction
- 4 Optimized glide pads with lateral wear allowance
- 5 Wide, rounded plastic crossbars - cable friendly
- 6 Dirt-repellent exterior
- 7 E-Chains® also available with reverse bending radius "RBR"
- 8 E-Chain® available with reverse bending radii
- 9 Tongue and groove for more stability

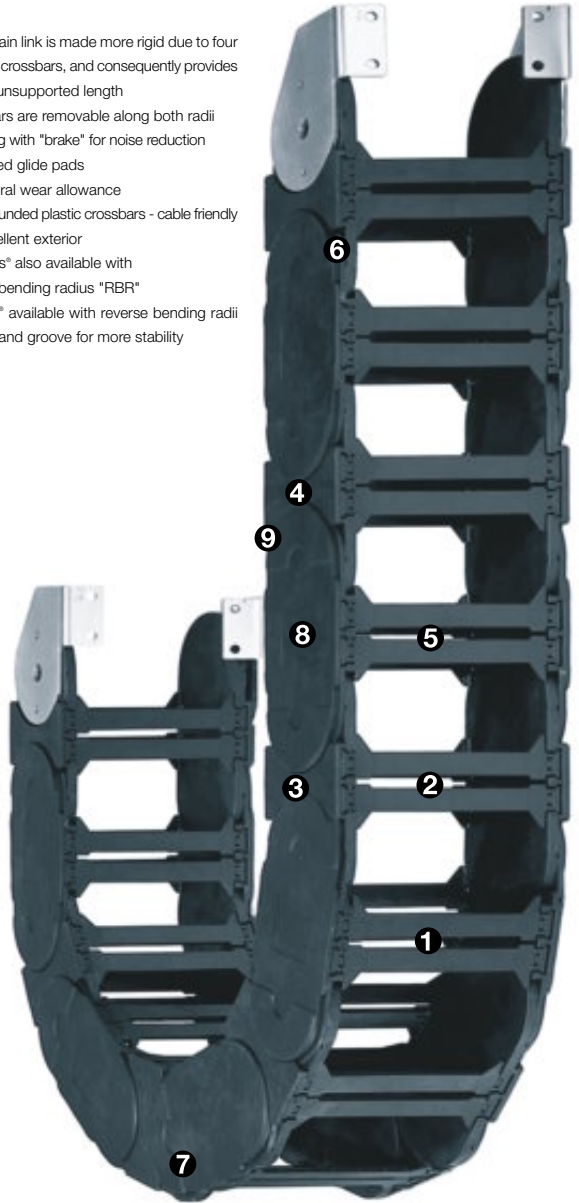

Order example complete E-Chain®

Please indicate chain-lengths or number of links **Example: 7 m or 28 links**

7 m **840.30.350.0**

E-Chain®

with 2 separators **8411** assembled every 2<sup>nd</sup> link

Interior separation

1 set **8000.1.12**

Mounting bracket

**Unsupported length**

$FL_G$  = with straight upper run

$FL_B$  = with permitted sag

Further information ► **Design, page 1.12**

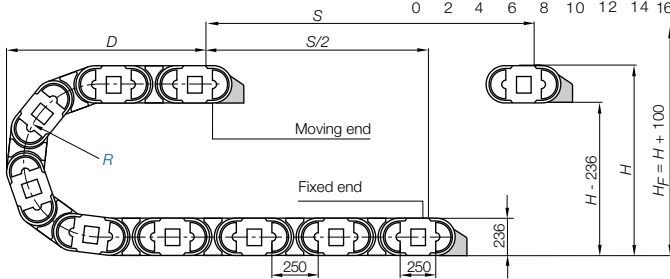
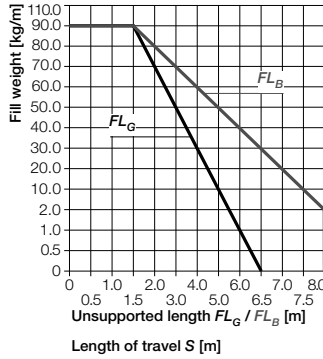
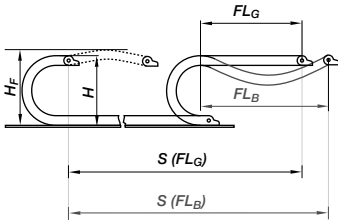

Pitch = 250 mm/link      Links/m = 4 (1000 mm)      Chain length =  $S/2 + K$

R	325	350	400	450	500	600	750	1000
H	886	936	1036	1136	1236	1436	1736	2236
D	725	750	800	850	900	1000	1150	1400
K	1525	1600	1760	1915	2075	2385	2860	3645
$D_2^{+25}$	*	*	*	*	*	*	*	*
$K_2$	*	*	*	*	*	*	*	*
$H_2$	*	*	*	*	*	*	*	*

\*upon request

- S = Length of travel
- R = Bending radius
- H = Nominal clearance height
- $H_F$  = Required clearance height
- $H_{in}$  = Trough inner height
- D = Overlength E-Chain® radius in final position
- $K = \pi \cdot R + \text{"safety"}$
- $D_2$  = Over length - long travels, gliding
- $K_2$  = "Further add-on"
- $H_2$  = "Mounting height"

**Other installation methods**

- Vertical, hanging  $\leq 120$  m
- Vertical, standing  $\leq 6$  m
- Side mounted, unupp.  $\leq 6$  m
- Rotary requires further calculation
- Unsupported length of upper run = upon request

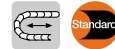

**Short travels - unsupported**

Unsupported E-Chains® feature positive camber over short travels. This must be accounted for when specifying the clearance height  $H_F$ . Please consult igus® if space is particularly restricted.

The required clearance height:  
 $H_F = H + 100$  mm  
(with 5,0 kg/m fill weight)

**Long travel lengths from 10 m to max. 450 m**      Chain length =  $S/2 + K_2$

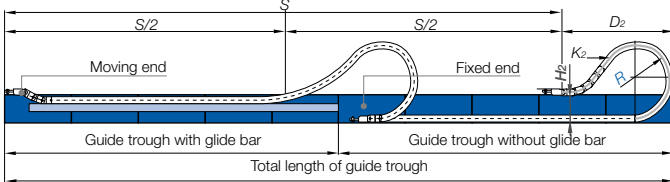

In case of travels between 4 and 10 m we recommend a longer unsupported length.



**Gliding, long travel applications (max. 450 m)**

In this case the E-Chain® upper run will be introduced in a guide trough on the lower run. We recommend to realize the engineering of such a plant by our technicians.

Speed / acceleration $FL_G$	max. 20 [m/s] / max. 200 [m/s²]
Speed / acceleration $FL_B$	max. 3 [m/s] / max. 6 [m/s²]
Gliding speed / acceleration (maximum)	max. 10 [m/s] / max. 50 [m/s²]
Material - permitted temperature °C	igumid G / -40° up to +120° C
Flammability class, igumid G	VDE 0304 IIC UL94 HB

**Technical Data**



Details of material properties  
► page 1.38



System E4/00  
Inner height: 204 mm

Phone +49- (0) 22 03-96 49-800  
Fax +49- (0) 22 03-96 49-222



► page 7.11

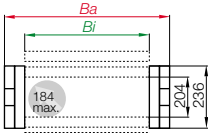

Part No. structure

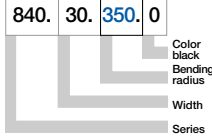

Series 840 - E-Chain® with crossbars every link

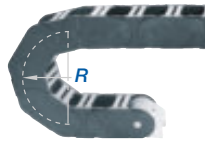

- E-Chains® of this size are basically used with crossbars every link
- Robust version
- Can be opened from two sides
- Removable crossbars



Part No.	Bi [mm]	Ba [mm]	Weight [kg/m]
840.13. <input type="text"/> .0	100	160	≈ 13,84
840.15. <input type="text"/> .0	113	173	≈ 13,87
840.16. <input type="text"/> .0	125	185	≈ 13,95
840.17. <input type="text"/> .0	138	198	≈ 14,04
840.18. <input type="text"/> .0	150	210	≈ 14,13
840.20. <input type="text"/> .0	163	223	≈ 14,17
840.21. <input type="text"/> .0	175	235	≈ 14,22
840.22. <input type="text"/> .0	188	248	≈ 14,27
840.23. <input type="text"/> .0	200	260	≈ 14,35
840.25. <input type="text"/> .0	213	273	≈ 14,43
840.26. <input type="text"/> .0	225	285	≈ 14,49
840.27. <input type="text"/> .0	238	298	≈ 14,57
840.28. <input type="text"/> .0	250	310	≈ 14,61
840.30. <input type="text"/> .0	263	323	≈ 14,72
840.31. <input type="text"/> .0	275	335	≈ 14,75
840.32. <input type="text"/> .0	288	348	≈ 14,82
840.33. <input type="text"/> .0	300	360	≈ 14,91
840.35. <input type="text"/> .0	313	373	≈ 15,06
840.36. <input type="text"/> .0	325	385	≈ 15,09
840.37. <input type="text"/> .0	338	398	≈ 15,11
840.38. <input type="text"/> .0	350	410	≈ 15,15
840.40. <input type="text"/> .0	363	423	≈ 15,34
840.41. <input type="text"/> .0	375	435	≈ 15,39
840.42. <input type="text"/> .0	388	448	≈ 15,50
840.43. <input type="text"/> .0	400	460	≈ 15,57
840.45. <input type="text"/> .0	413	473	≈ 15,63
840.46. <input type="text"/> .0	425	485	≈ 15,69
840.47. <input type="text"/> .0	438	498	≈ 15,72
840.48. <input type="text"/> .0	450	510	≈ 15,80
840.50. <input type="text"/> .0	463	523	≈ 15,87
840.51. <input type="text"/> .0	475	535	≈ 15,91
840.52. <input type="text"/> .0	488	548	≈ 15,93
840.53. <input type="text"/> .0	500	560	≈ 16,00
840.55. <input type="text"/> .0	513	573	≈ 16,31
840.60. <input type="text"/> .0	563	623	≈ 16,47

Available bending radii  
R [mm]  325  350  400  450  500  600  750  1000

Supplement Part No. with required radius. Example: 840.30.  350.0

0 = standard color, other colors ▶ page 1.39 · Pitch = 250 mm/link - Links/m = 4

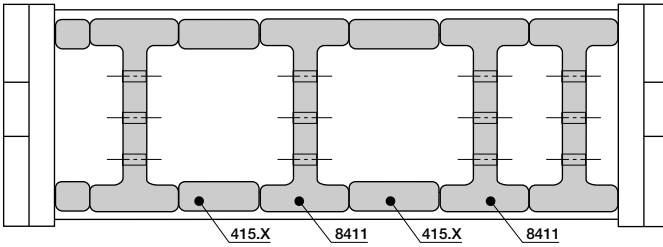

**Option 1**

- Vertical separators
- Spacers

**Option 1: Vertical separators and spacers**

Vertical separators are used if a vertical subdivision of the E-Chain® interior is required - By standard vertical separators are assembled every other E-Chain® link.

- **Standard separator 8401 for E-Chains®** offers safe stability due to its wide base design, also when used with thick cables or hoses.

- Vertical separators in side-mounted applications, for instance, can be fixed in position by means of **spacer 405.X for E-Chains®**. A wide range of intervals between the vertical separators is adjustable here.

- **Note on spacers:** The available interior height is reduced by 2 mm per spacer (4 mm when spacers are fitted on both sides). To avoid this, the parts can also be installed from the outside on the opening crossbar.



<b>Vertical separator for E-Chains®</b>	
unassembled	8401
assembled	8411



<b>Spacer* for E-Chains®</b>	
unassembled	405.10
assembled	415.10



<b>Spacer* for E-Chains®</b>	
unassembled	405.15
assembled	415.15



<b>Spacer* for E-Chains®</b>	
unassembled	405.20
assembled	415.20



<b>Spacer* for E-Chains®</b>	
unassembled	405.30
assembled	415.30



<b>Spacer* for E-Chains®</b>	
unassembled	405.40
assembled	415.40

\*For side-mounted applications

Single crossbar, E-Chain®, **Part No. 450.Bi**

Right side link\*, single part, **Part No. 800.02. R**

Right side link\*, single part, **Part No. 800.01. R**

Single crossbar, E-Chain®, **Part No. 450.Bi**



Vertical separator  
8401



Spacer  
405.10



Spacer  
405.15



Spacer  
405.20



Spacer  
405.30



Spacer  
405.40

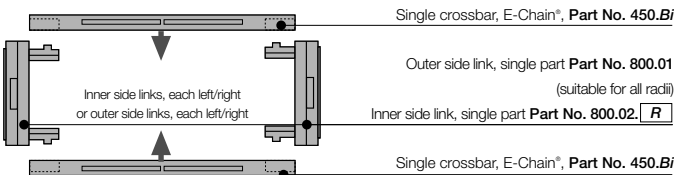

**Part No. E-Chain® links, single parts**

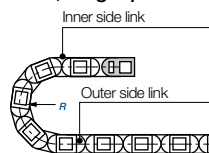





**Option steel - pivoting**

- For pivoting connections
- One part (two-piece) for all chain widths
- Electrically conductive

Moving end  
8000.1

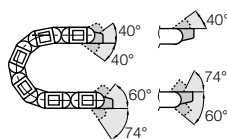

Fixed end  
8000.2



Possible installation conditions -  
Further installation angles ► installation sketch

Phone +49- (0) 22 03-96 49-800  
Fax +49- (0) 22 03-96 49-222

igus® GmbH  
51147 Cologne

Moving end  
8000.1

Fixed end  
8000.2

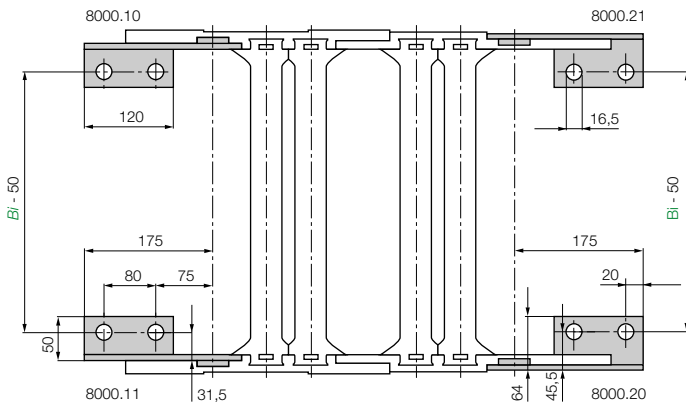

**Note mounting brackets:**

Depending on the E-Chain® length, the carrier will end with outer or inner side links. For the best appearance, make sure the chain ends with outer side link whenever possible. An odd number of links will always end with outer side links.

**Part No. Mounting bracket**

- 8000.1,12** Full attachment set (both sides) for E-Chain®, ending with outer side link
- 8000.3,12** Full attachment set (both sides) for E-Chain®, beginning with outer side link (moving end), ending with inner side link (fixed end)
- 8000.1** Mounting bracket set (one side) for outer side link
- 8000.2** Mounting bracket set (one side) for inner side link

System E4/00 | Series 840 | Accessories | Strain Relief



**Tiewrap plate as individual part**

As individual component screwed on KMA. Can be plugged in the mounting brackets. **Details ► chapter 10**

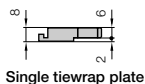

Single tiewrap plate

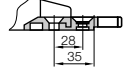

Shown assembled

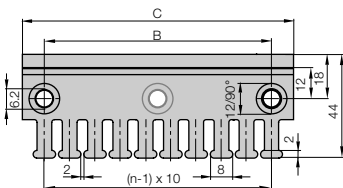

Tiewrap plate	No. of teeth $n$	Dim. C [mm]	Dim. B [mm]	Center bore
3050.ZB	5	50	30	-
3075.ZB	7	75	55	-
3100.ZB	10	100	80	-
3115.ZB	11	115	95	-
3125.ZB	12	125	105	-
3150.ZB	15	150	130	-
3175.ZB	17	175	155	-
3200.ZB	20	200	180	+
3225.ZB	22	225	205	+
3250.ZB	25	250	230	+

(- = no / + = yes)

Internet: [www.igus.de](http://www.igus.de)  
E-mail: [info@igus.de](mailto:info@igus.de)

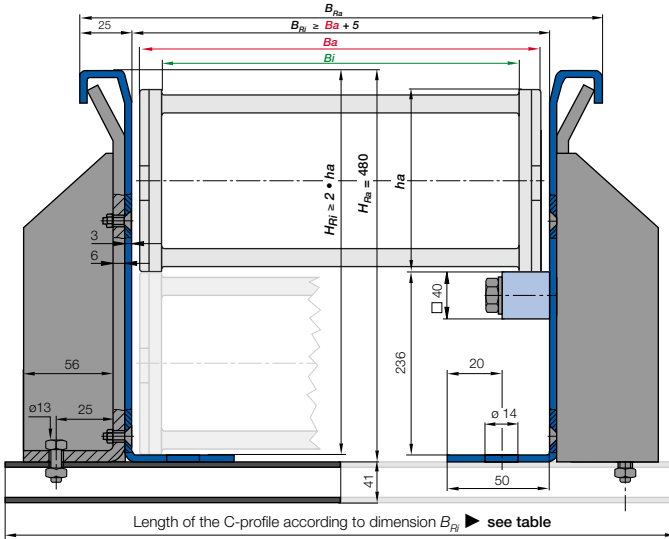

Guide troughs are used with applications where the upper run of the E-Chain® glides on the lower run. If using igus® steel guide troughs, the following components are required:

- Guide trough without glide bars  
Part No. 90.30
- Guide trough with glide bars  
Part No. 90.31
- Installation sets as end connectors  
Part No. 90.50.XX

.XX indicates the length of the C-profile on which the guide trough is mounted. The values and part numbers are specified in the table on the left. Standard length of the trough components and glide bars is 2 m. The required overall length of the guide trough directly correlates to the length of travel. Special dimensions are available for confined spaces.

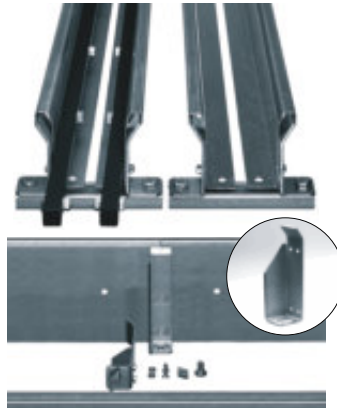

Illustration top: Guide trough with and without glide bar.  
Illustration bottom: assembly kit with specially strengthened installation angle bracket for 90.30 and 90.31

- $Ba$  = Outer width E-Chains® / E-Tube
- $Bi$  = Inner width E-Chains® / E-Tube
- $ha$  = Outer height E-Chains® / E-Tube
- $H_{Ri}$  = Inner trough height
- $H_{Ra}$  = Outer trough height
- $B_{Ri}$  = Inner trough width ▶ depends on dim.  $Ba$
- $B_{Ra}$  = Outer trough width
- $n_{Mon}$  = Number of installation sets (left/right)
- $n_{Ri}$  = Number of trough sets (left/right)
- $H_{Ri} \geq 2 \cdot ha$
- $B_{Ri} \geq Ba + 5$
- = Guide trough set
- = Installation set
- = Glide bar
- = C-profile

## Installation set with C-profile

840.13.325.0 ▶ Order example

	Part No.	Installation set
.13	165	90.50.350
.15	178	90.50.350
.16	190	90.50.375
.17	203	90.50.375
.18	215	90.50.400
.20	228	90.50.400
.21	240	90.50.425
.22	253	90.50.425
.23	265	90.50.450
.25	278	90.50.450
.26	290	90.50.475
.27	303	90.50.475
.28	315	90.50.500
.30	328	90.50.500
.31	340	90.50.525
.32	353	90.50.525
.33	365	90.50.550
.35	378	90.50.550
.36	390	90.50.575
.37	403	90.50.575
.38	415	90.50.600
.40	428	90.50.600
.41	440	90.50.625
.42	453	90.50.625
.43	465	90.50.650
.45	478	90.50.650
.46	490	90.50.675
.47	503	90.50.675
.48	515	90.50.700
.50	528	90.50.700
.51	540	90.50.725
.52	553	90.50.725
.53	565	90.50.750
.55	578	90.50.750
.60	628	90.50.800

### Order example: Length of travel 30 m - Center mounted for Series 840.13.325.0 with $B_{Ri} = 165$

Guide trough set (set of 2 trough side parts, incl. glide strips) <b>without</b> glide bar	
Order text: 16 m Guide trough without glide bar (8 x 2 m sections)	<b>Part No. 90.30</b>
Guide trough set (set of 2 trough side parts, incl. glide strips) <b>with</b> glide bar	
Order text: 16 m Guide trough with glide bar (8 x 2 m sections)	<b>Part No. 90.31</b>
Installation set "Basic" complete (Guide trough-sets + 1)	
Order text: 17 Installation sets (with C-profile)	<b>Part No. 90.50.350</b>

Principle sketch: Number of installation sets to be installed = Number of trough sections + 1

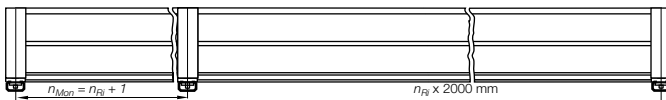





# E4/4

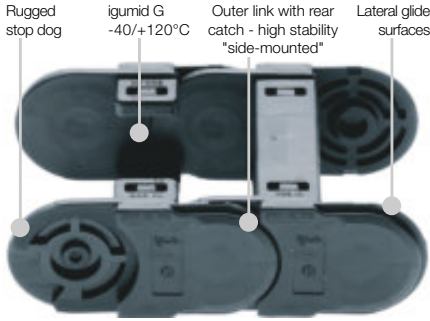

- Best unsupported lengths "side-mounted"
- RoI E-Chain™ links available
- For very long travels up to 200 - 800 m
- High torsional rigidity
- Good for tough environments with dirt and debris
- ESD Version available
- Interior separation possibilities
- You can find more technical data about the material, chemical resistance, temperatures ► **Design, from page 1.38**

### Opening-principle

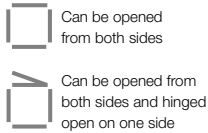

### Dimensioning

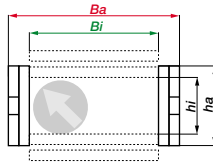

### Bending radius

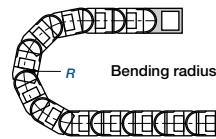

### Part No. structure

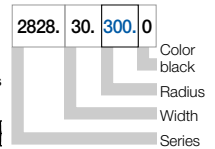

### Selection table

Series	Inner height <i>hi</i> [mm]	Inner width <i>Bi</i> [mm]	Outer width <i>Ba</i> [mm]	Outer height <i>ha</i> [mm]	Bending radius <i>R</i> [mm]	Unsupported length max. [m]	page
<b>Crossbars every link - for particularly demanding applications</b>							
2828	32	50 - 400	73 - 423	54	63 - 300	3,50	7.92
3838	42	50 - 400	77 - 427	64	75 - 350	3,80	7.104
4040	56	50 - 600	86 - 636	84	135 - 500	4,50	7.116
4040HD	56	50 - 600	104 - 654	84	135 - 500	4,50	7.128
5050	80	50 - 600	100 - 650	108	150 - 1000	6,00	7.136
5050HD	80	50 - 600	110 - 660	108	300 - 500	6,00	7.148
<b>Crossbars every other link - for almost all applications</b>							
2928	32	50 - 400	73 - 423	54	63 - 300	3,50	7.92
3938	42	50 - 400	77 - 427	64	75 - 350	3,80	7.104
4140	56	50 - 600	86 - 636	84	135 - 500	4,50	7.116
5150	80	50 - 600	100 - 650	108	150 - 1000	6,00	7.136
<b>E-Tube - fully enclosed, excellent cable protection</b>							
R7728	32	50 - 300	73 - 323	54	125 - 300	3,50	7.92
R7838	42	50 - 300	77 - 327	64	125 - 350	3,80	7.104
R8840	56	75 - 462	111 - 499	84	150 - 500	4,50	7.116
R8840HD	56	75 - 462	129 - 529	84	150 - 300	4,50	7.128
R9850	80	75 - 462	125 - 513	108	200 - 1000	6,00	7.136
R9850HD	80	75 - 462	135 - 5122	108	200 - 500	6,00	7.148

Comparison of the main characteristics

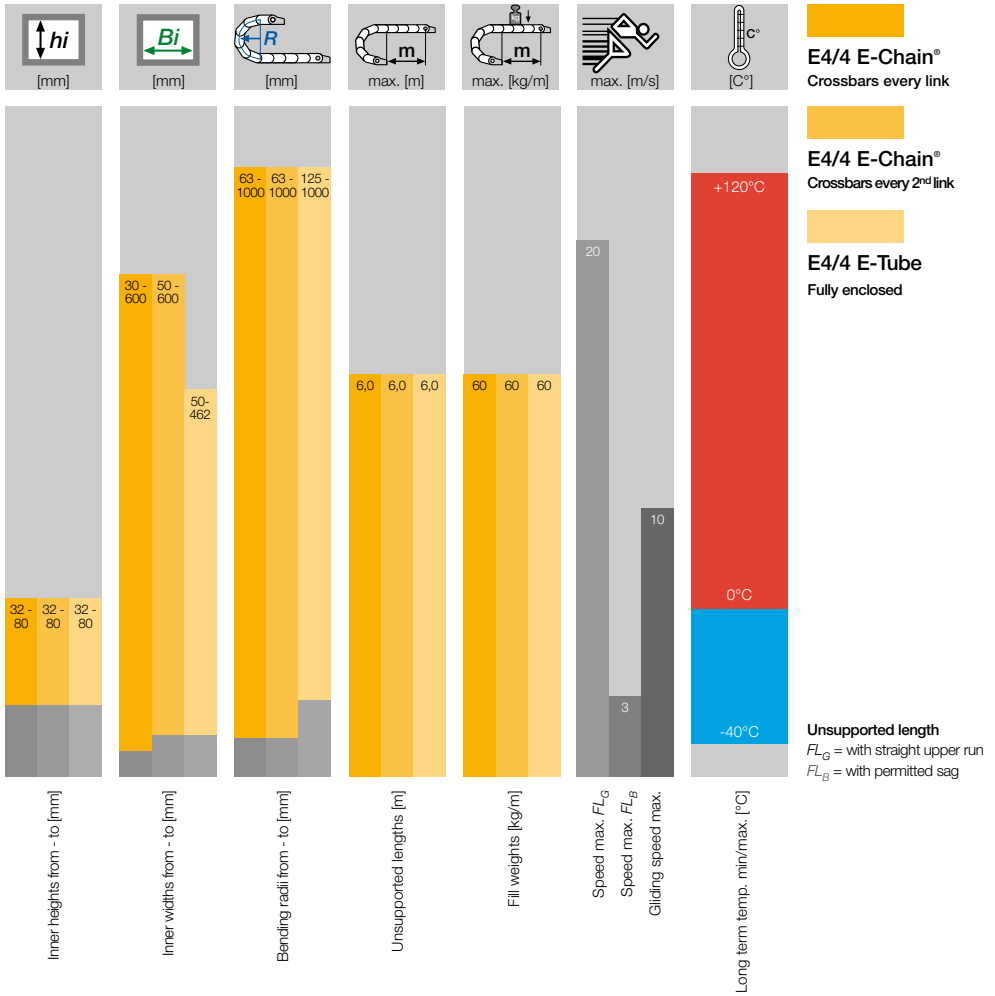

Additional quality features - System E4/4

Side-mounted - unsupported

ATEX/ESD: Excellent performance with the special material igumid ESD (upon request) "Rear grip" achieves long-term electrical conductivity

High torsional rigidity

System E4 - 4-piece E-Chain® links

System E4/4 proved with long travels

**System E4/4** (pronounced: E-4-4) come out to solve applications in two areas: **The extreme long travels and the free-hanging side mounted situations.** The famous tongue and groove between two links is one feature to make that possible. **Push-forces and rigidity are increased - tolerance against dirt and debris rises. Special "Roller-links"** establishes E4/4 as the true long-travel specialist. The tongue and groove design also enables the **excellent ESD/ATEX performance.** The chain links are tightly linked to each other, so that electricity can flow through them when in contact with each other (Please note: This is valid only for the special conductive material igumid ESD and is not applicable for the standard series in this catalog)

### Typical industries & applications

- Cranes: RTG, Quay cranes, many more
- Compost plants
- Gypsum plants, concrete plants, chemical plants
- Agricultural plants
- Mineral plants
- Machine tools: free-hanging-on-the-side applications
- Construction machinery
- ESD applications
- Heavy machinery
- Steel plants
- Shipyards
- Welding plants
- General machinery



E4/4 - The "tongue-and-groove" design makes it the Series for "special cases"



Special case: Side-mounted, unsupported - "tongue and groove" design offers stability



Many successful RoI E-Chain® applications, i.e. one of the igus® longest travels at the moment on 2 ship unloaders in Malaysia, both equipped with a RoI E-Chain® at 441,3 m travel length



Special case: High lateral accelerations



200 m travels and more possible



System E4/4 | E-Chains® and E-Tubes | **Assembling**



Remove crossbars at connection point. Slide side links into each other - Press together



Join the side links - join the second side link by pressing from the top



Join the side links together on the opposite side by applying pressure to the outer link



Assemble crossbars - Push down and snap in by using a screwdriver



Assemble clips (E-Chains®) with crossbars every other link - Push down and snap in



Assemble E-Tube lids/bottoms - Attach to the connector at an angle - Snap in

System E4/4 | E-Chains® and E-Tubes | **Separating**



Remove crossbars, clips, and lids on two adjacent chain links. Guide the screwdriver into the slot between side links and release it by levering it and separate the E-Chain®



**E-Chains® | Opening**



Remove crossbars - Insert screwdriver into the slot, push down, release by lever action



Remove clips - Insert screwdriver into the slot and push down, release by lever action

**E-Tube | Opening**



Remove lids/bottoms - Insert screwdriver into the slot, release by lever action

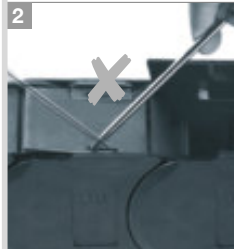

Release only **one side** to swivel the lid



You can find an assembly video on the web ► [www.igus.de/en/video](http://www.igus.de/en/video)

Price index



Side-mounted - unsupported



ESD classification:  
Electrically conductive ESD/ATEX version upon request



High torsional rigidity



Opening E-Chains®: Remove crossbars and clips - Insert screwdriver into the slot, push down, release by lever action



Remove lids/bottoms (E-Tubes) - Insert screwdriver into the slot, release by lever action



When to use the Series 2828/2928/R7728:

- When high torsional or shearing forces are expected
- For side-mounted applications involving large unsupported lengths
- For long-term operation in very moist environments
- Also available as Rol E-Chain®



When not to use it:

- If a quieter version is required  
▶ Series 280/290/R770, page 7.28

- 1 High side-mount stability due to tongue and groove
- 2 High torsional rigidity
- 3 Crossbars on E-Chains® are removable along both radii
- 4 Closed and open styles can be combined
- 5 Removable lids along inner radius
- 6 Hinged snap-open removable lids along outer radius of E-Tube
- 7 Lateral glide surfaces for side-mounted operation
- 8 Wide, rounded plastic crossbars - cable friendly
- 9 KMA mounting brackets with attachment points on all sides
- 10 Locking or pivoting mounting brackets available
- 11 E-Chain® also available with reverse bending radii



Rol E-Chain® Series 2828R/7728R available upon request

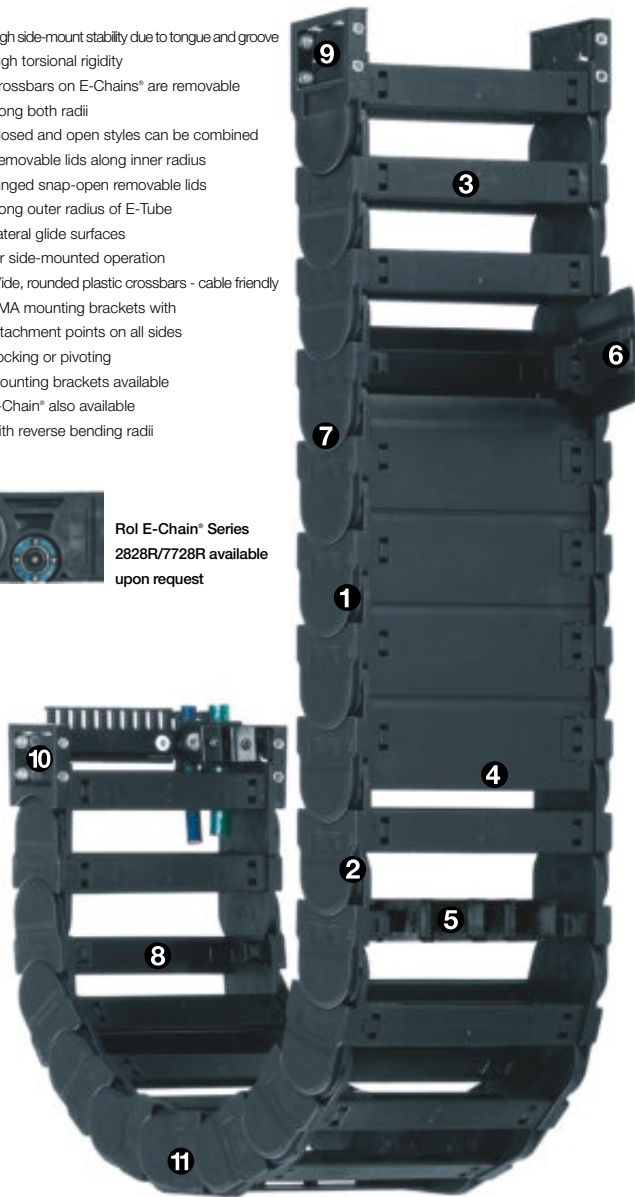

Order example complete E-Chain®

Please indicate chain-lengths or number of links Example: 3 m or 54 links

3 m 2828.30.300.0

E-Chain®

with 2 separators 282 assembled every 2<sup>nd</sup> link

Interior separation

1 set 28280.30.12C

Mounting bracket

**Unsupported length**

$FL_G$  = with straight upper run

$FL_B$  = with permitted sag

Further information ► **Design, page 1.12**

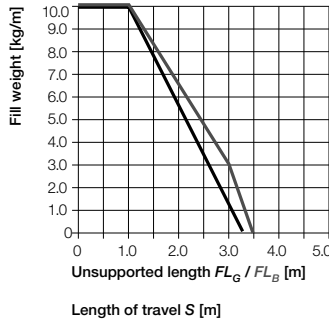
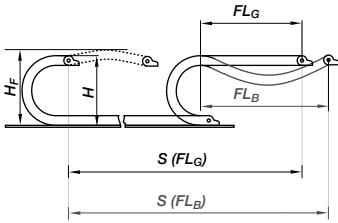

- $S$  = Length of travel
  - $R$  = Bending radius
  - $H$  = Nominal clearance height
  - $H_F$  = Required clearance height
  - $H_{in}$  = Trough inner height
  - $D$  = Overlength E-Chain® radius in final position
  - $K = \pi \cdot R + \text{"safety"}$
  - $D_2$  = Overlength - long travels, gliding
  - $K_2$  = "Further add-on"
  - $H_2$  = "Mounting height"
- \*if the mounting bracket location is set lower

**Other installation methods**

- Vertical, hanging  $\leq 70$  m
- Vertical, standing  $\leq 5$  m
- Side mounted, un supp.  $\leq 2$  m
- Rotary requires further calculation
- Unsupported length of upper run = upon request

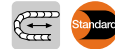

**Short travels - unsupported**

Unsupported E-Chains® feature positive camber over short travels. This must be accounted for when specifying the clearance height  $H_F$ . Please consult igus® if space is particularly restricted.

The required clearance height:  
 $H_F = H + 40$  mm  
(with 2,0 kg/m fill weight)

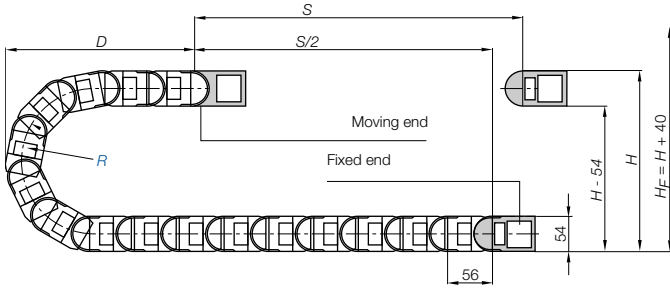

Pitch = 56 mm/link    Links/m = 18 (1008 mm)    Chain length =  $S/2 + K$

R	063	075	100	125	150	175	200	220	250	300
$H_{20}^{+0}$	180	205	255	305	355	405	455	495	555	655
D	130	150	175	200	225	250	275	295	325	375
K	340	380	465	550	620	700	780	850	940	1110
$D_2^{+20}$	-	-	370	445	625	655	770	870	930	1240
$K_2$	-	-	616	784	1008	1064	1288	1456	1568	1960
$H_2$	-	-	166	166	166	166	166	166	166	166

**Long travel lengths from 10 m to max. 200 m    Chain length =  $S/2 + K_2$**

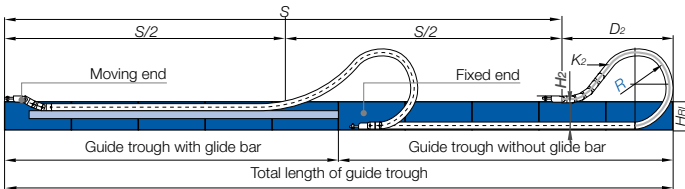

In case of travels between 4 and 10 m we recommend a longer unsupported length.



**Gliding, long travel applications (max. 200 m)**

In this case the E-Chain® upper run will be introduced in a guide trough on the lower run. We recommend to realize the engineering of such a plant by our technicians.

Speed / acceleration $FL_G$	max. 20 [m/s] / max. 200 [m/s]
Speed / acceleration $FL_B$	max. 3 [m/s] / max. 6 [m/s]
Gliding speed / acceleration (maximum)	max. 10 [m/s] / max. 50 [m/s]
Material - permitted temperature °C	igumid G / -40° up to +120° C
Flammability class, igumid G	VDE 0304 IIC UL94 HB

**Technical Data**



Details of material properties  
► page 1.38



igus® E-ChainSystems®

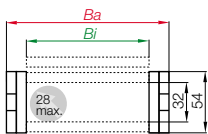

Part No. structure

2828. 30. 300. 0



Series 2828 - E-Chain® with crossbars every link

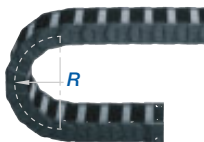

- Crossbars every link
- For rigid hydraulic hoses
- For applications particularly demanding
- Can be opened from two sides



Phone +49- (0) 22 03-96 49-800  
Fax +49- (0) 22 03-96 49-222

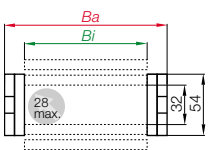

Part No. structure

2928. 30. 300. 0

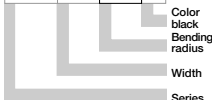

Series 2928 - E-Chain® with crossbars every 2<sup>nd</sup> link

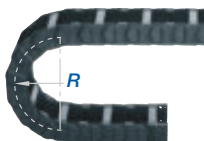

- Crossbars every 2<sup>nd</sup> link = Standard
- For nearly every situation
- Can be opened from two sides
- Easy assembly
- Stable
- Attractive price



igus® GmbH  
51147 Cologne

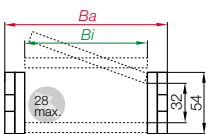

Part No. structure

7728. 30. 300. 0



Series R7728 - Fully enclosed E-Tube

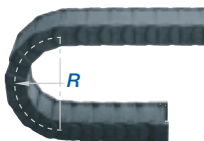

- Fully enclosed
- Excellent cable protection against dirt
- Protection against hot chips (up to 900°C)
- Lids along the entire inner radius are completely removable. Lids along the entire outer radius are single sided snap-open with a hinge on the other side to keep them attached to the chain or completely removable.



Internet: [www.igus.de](http://www.igus.de)  
E-mail: [info@igus.de](mailto:info@igus.de)

**Roll instead of gliding: Rol E-Chain®**

Special solution for long travels. 75% less drive power (gliding application) with igus® Rol E-Chain®.

Series 2828R - Order example 2828R.30.220.0

Further information: [www.igus.de/en/rol](http://www.igus.de/en/rol)  
or phone: +49-0 22 03-96 49-800



TIP!

Part No.		Bi [mm]	Ba [mm]	2828 [kg/m]	2928 [kg/m]	R7728 [kg/m]
2828/2928/7728.05	<input type="checkbox"/> .0*	50	74	≈ 1,73	≈ 1,64	≈ 2,63
2828/2928.06	<input type="checkbox"/> .0	68	92	≈ 1,79	≈ 1,67	-
2828/2928/7728.07	<input type="checkbox"/> .0	75	99	≈ 1,84	≈ 1,69	≈ 2,75
2828/2928.087	<input type="checkbox"/> .0	87	111	≈ 1,93	≈ 1,73	-
2828/2928/7728.10	<input type="checkbox"/> .0	100	124	≈ 2,02	≈ 1,78	≈ 2,83
2828/2928/7728.11	<input type="checkbox"/> .0	108	132	≈ 2,08	≈ 1,81	≈ 2,94
2828/2928.112	<input type="checkbox"/> .0	112	137	≈ 2,15	≈ 1,84	-
2828/2928/7728.12	<input type="checkbox"/> .0	125	149	≈ 2,20	≈ 1,87	≈ 3,03
2828/2928.137	<input type="checkbox"/> .0	137	162	≈ 2,29	≈ 1,91	-
2828/2928/7728.15	<input type="checkbox"/> .0	150	174	≈ 2,38	≈ 1,96	≈ 3,19
2828/2928.162	<input type="checkbox"/> .0	162	187	≈ 2,44	≈ 1,99	-
2828/2928/7728.17	<input type="checkbox"/> .0	168	192	≈ 2,51	≈ 2,02	≈ 3,39
2828/2928.18	<input type="checkbox"/> .0	175	199	≈ 2,56	≈ 2,05	-
2828/2928.187	<input type="checkbox"/> .0	187	212	≈ 2,65	≈ 2,09	-
2828/2928/7728.20	<input type="checkbox"/> .0	200	224	≈ 2,74	≈ 2,14	≈ 3,59
2828/2928.212	<input type="checkbox"/> .0	212	237	≈ 2,87	≈ 2,20	-
2828/2928.23	<input type="checkbox"/> .0	225	249	≈ 2,92	≈ 2,22	-
2828/2928.237	<input type="checkbox"/> .0	237	262	≈ 3,05	≈ 2,29	-
2828/2928/7728.25	<input type="checkbox"/> .0	250	274	≈ 3,10	≈ 2,32	≈ 4,04
2828/2928.262	<input type="checkbox"/> .0	262	286	≈ 3,19	≈ 2,36	-
2828/2928.28	<input type="checkbox"/> .0	275	299	≈ 3,28	≈ 2,41	-
2828/2928.29	<input type="checkbox"/> .0	287	312	≈ 3,37	≈ 2,45	-
2828/2928/7728.30	<input type="checkbox"/> .0	300	324	≈ 3,46	≈ 2,50	≈ 4,43
2828/2928.312	<input type="checkbox"/> .0	312	337	≈ 3,59	≈ 2,56	-
2828/2928.325	<input type="checkbox"/> .0	325	349	≈ 3,68	≈ 2,60	-
2828/2928.337	<input type="checkbox"/> .0	337	362	≈ 3,77	≈ 2,65	-
2828/2928.350	<input type="checkbox"/> .0	350	374	≈ 3,86	≈ 2,69	-
2828/2928.362	<input type="checkbox"/> .0	362	387	≈ 3,95	≈ 2,74	-
2828/2928.375	<input type="checkbox"/> .0	375	399	≈ 4,04	≈ 2,79	-
2828/2928.387	<input type="checkbox"/> .0	387	412	≈ 4,11	≈ 2,82	-
2828/2928.400	<input type="checkbox"/> .0	400	424	≈ 4,18	≈ 2,86	-

Available bending radii

R [mm] 063\*\* 075\*\* 100\*\* 125 150 175 200 220 250 300

Supplement Part No. with required radius. Example: 2828.30.300.0

0 = standard color, other colors ► page 1.39 · Pitch = 56 mm/link - Links/m = 18

\*Removable lid only, no hinged option · \*\*not available for R7728

**TIP!**

## Hot Chips up to 850°C

E-Tubes that repel hot chips, up to 850 °C  
Some applications, depending on amount and size of the chips, can burn or melt the surface. That is no longer the case with the new igus® "Iguamid HT" material.

Further information:  
www.igus.de/en/HT  
or phone:  
+49-0 22 03-96 49-800

Extender crossbar for large diameter hoses ► page 7.92

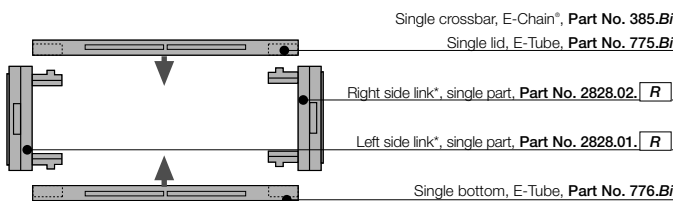

**Part No. E-Chain® - links, single parts**  
\*View from the fixed point of the E-Chain®/E-Tube

System E4/4  
Inner height: 32 mm

Phone +49- (0) 22 03-96 49-800  
Fax +49- (0) 22 03-96 49-222

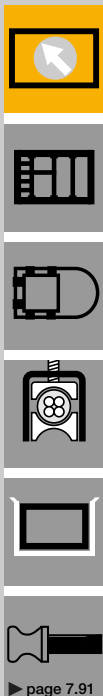

► page 7.91



**Option 1**

- Vertical separators
- Spacers
- Locking separators
- Asymmetric separators

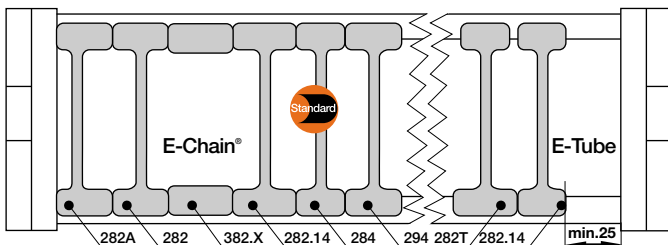

Vertical separator  
281



Vertical separator  
281T



Vertical separator  
281.14



Vertical separator  
283



Spacer  
381.10



Spacer  
381.15



Spacer  
381.20



Locking separator  
293



Asymmetric  
separator 281A

**Vertical separator  
for E-Chains®**

unassembled	281
assembled	282



**Vertical separator  
for E-Tubes**

unassembled	281T
assembled	282T



**Vertical separator  
for E-Chains®/E-Tubes**

unassembled	281.14
assembled	282.14



**Vertical separator  
for E-Chains®**

unassembled	283
assembled	284



**Spacer®  
for E-Chains®**

unassembled	381.10
assembled	382.10



**Spacer®  
for E-Chains®**

unassembled	381.15
assembled	382.15



**Spacer®  
for E-Chains®**

unassembled	381.20
assembled	382.20



**Locking separator  
for E-Chains®**

unassembled	293
assembled	294



**Asymmetric separator  
for E-Chains®**

unassembled	281A
assembled	282A



\*For side-mounted applications

**Option 1: Vertical separators and spacers**

Vertical separators are used if a vertical subdivision of the E-Chain® interior is required - By standard vertical separators are assembled every other E-Chain® link. **Note:** Observe a lateral spacing of at least 25 mm for E-Tubes!

● **Standard separator 281 for E-Chains®** offers safe stability due to its wide base design, also when used with thick cables or hoses. If the distance needed between separators is greater than this separator's dimension, we offer the **vertical separator 281.14**.

● **The vertical separator 281T for E-Tubes** clamps to the fixed radius and remains free along the other radius to facilitate lid removal. If installing these yourself, please ensure that they are identically aligned. If the distance needed between separators is greater than this separator's dimension, we offer the **vertical separator 281.14**.

● **Vertical separator 283 with a narrow base for E-Chains®** with applications where a large number of small cables need to be individually separated.

● Vertical separators in side-mounted applications, for instance, can be fixed in position by means of **spacer 381.X for E-Chains®**. A wide range of intervals between the vertical separators is adjustable here.

● **Note on spacers:** The available interior height is reduced by 2 mm per spacer (4 mm when spacers are fitted on both sides). To avoid this, the parts can also be installed from the outside on the opening crossbar.

**Additionally:**

● **Locking separator 293 for E-Chains®** - with increased retention force for applications exposed to very high humidity or extreme loads. The extra retention force is achieved by asymmetric claws for the crossbar. Ensure proper alignment.

● **Asymmetric separator 281A for E-Chains®** (not for E-Tubes) with an 12-mm base, for combinations between spacers of different widths and vertical separators in side-mounted applications, for instance.

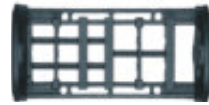
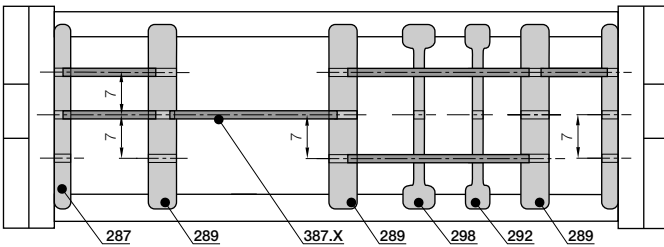

**Option 2**

- Side plates
- Middle plates
- Vertical separators
- Slotted separators
- Open slotted separators

**Option 2: Shelves**

For applications involving many cables with different diameters. The shelves can be arranged elevator-shifted with different bottoms.

- Side plates 286, middle plates 288 and shelves 386.X form the basic pattern of a shelf system. Shelves of various widths can be arranged at 3 different heights (in 7 mm increments).

- For special applications: **Vertical separator with injection moulded shelf 281.S.57** (57,5 mm) or **281.S.45** (45 mm)

- **Slotted separators 291** (not for E-Tubes), are used for very fine subdivisions. However, they cannot be retrofitted into an existing separation system without dismantling the interior separators first.

- The unilateral **open slotted separator 297** can be retrofitted into an existing interior separation system without a need for dismantling the interior separators. During an installation of open slotted separators, the top and bottom notches cannot be occupied by shelves.



Side plate for E-Chains®/E-Tubes		
un assembled	286	
assembled		287



Middle plate for E-Chains®/E-Tubes		
un assembled	288	
assembled		289

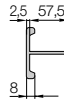

Vertical separator for E-Chains®/E-Tubes		
un assembled	281.S.57	
assembled		282.S.57



Vertical separator for E-Chains®/E-Tubes		
un assembled	281.S.45	
assembled		282.S.45

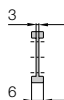

Slotted separator for E-Chains®		
un assembled	291	
assembled		292



Open slotted separator for E-Chains®/E-Tubes		
un assembled	297	
assembled		298

Width X [mm]	Part No. un assembled	Part No. assembled
18	386.18	387.18
23	386.23	387.23
25	386.25	387.25
28	386.28	387.28
33	386.33	387.33
43	386.43	387.43
50	386.50	387.50
54	386.54	387.54
62	386.62	387.62

Width X [mm]	Part No. un assembled	Part No. assembled
75	386.75	387.75
87	386.87	387.87
100	386.100	387.100
108	386.108	387.108
125	386.125	387.125
150	386.150	387.150
175	386.175	387.175
200	386.200	387.200
208	386.208	387.208



Side plate 286



Middle plate 288



Vertical separator 281.S.57



Vertical separator 281.S.45



Slotted separator 291



Open slotted separator 297



Shelf 386.X



Shelf

System E4/4  
Inner height: 32 mm

Phone +49- (0) 22 03-96 49-800  
Fax +49- (0) 22 03-96 49-222







### Extension links - for extremely wide E-Chains® up to 3,0 m

- For applications in which particularly high fill weights necessitate extremely wide E-Chains® (up to 3000 mm)
- The extension link design allows virtually limitless side-by-side attachment of chains
- The unsupported length of a chain can be increased when additional loads are required
- Extension links can be used with E-Chains®, E-Tubes or as a combination of both
- They are suitable for unsupported and gliding applications in a guide trough
- E-Chains® with extension links are attached with KMA or steel mounting brackets



Part No. structure  
2828.10 /20 /10. 200.0  
2828.Bi1/Bi2/Bi3. R 1.0

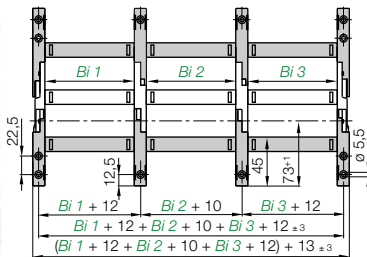

### Extender crossbars - careful guide of hoses applications

- Suitable for hoses with a maximum outer diameter of 115 mm
- Gliding operation with crossbars assembled along the outer radius and a special guide trough
- Gliding operation not guaranteed with crossbars assembled along the inner radius
- The extender crossbar can either be attached to the side links directly or can be used in combination with two stranded snap-open crossbars

Consult igus® for your extender crossbar applications. We are happy to assist you with your design layout

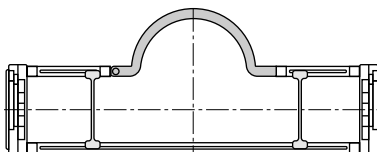

385.15.RHD115 round extender crossbar combined with snap-open crossbars

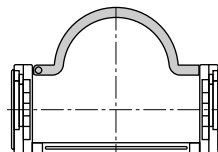

385.18.RD115 round strap assembled directly on the side section

Part No.	Max Ø [mm] hose	Form	Installation	Combination with
			side link	snap-open crossb.
385.15.RHD115	115	○	-	+
385.18.RD115	115	○	+	-

○ = round + = yes / - = no



### Hinged crossbars

- Typically E-Chain® crossbars are completely removable. In cases where the snap-open crossbars have to remain at the open link of the E-Chain®, a hinged design has been developed
- Length: 37,5 mm **Part No. 385.02** / snap-open crossbar (shortened): Bi-37,5 mm **Part No. 385.03**
- Please consult igus® for design assistance

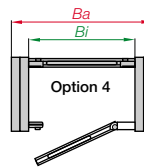
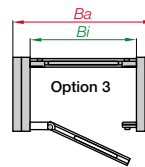
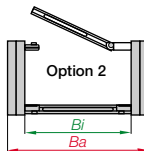
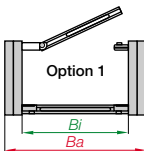
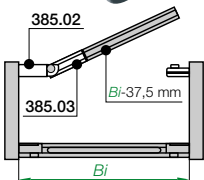

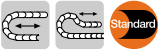

### The Standard - Option KMA\* - pivoting

- Recommended for unsupported and gliding applications
- Confined installation conditions
- Option - integrated C-profile strain relief device with Chainfix clip or strain relief tiwrap plates
- Corrosion resistant
- Universal mountable with attachment capability on all sides

\*KMA = Polymer Metal Mounting Bracket

Moving end  
28280/77280...1

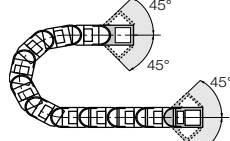

Fixed end  
28280/77280...2



The attachment variants arising automatically by the choice of the KMA mounting bracket

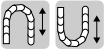
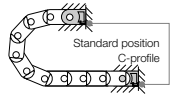

### Option KMA - locking

- Recommended for vertical hanging / standing applications

**Additionally:**

- Universal mountable
- C-profile option
- Corrosion resistant
- Locked connections
- At very high acceleration

Moving end  
29280/78280...1

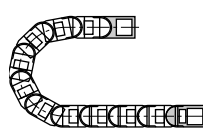

Fixed end  
29280/78280...2



The attachment variants arising automatically by the choice of the KMA mounting bracket

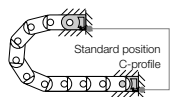

**Fixed end**

28280/77280...2 (pivoting)

29280/78280...2 (locking)

**Moving end**

(pivoting) 28280/77280...1

(locking) 29280/78280...1

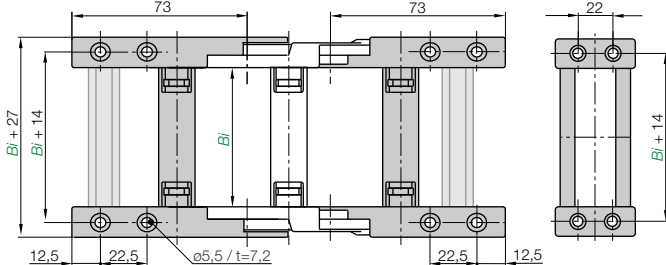

### Dimensions and order configurations

**Part No. structure (pivoting)**

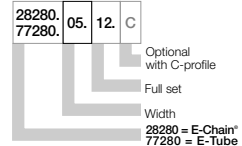

**Part No. structure (locking)**

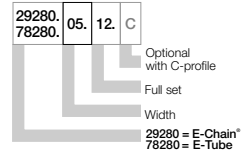

Width index	Part No. pivoting	Part No. locking	C-profile option [mm]	Width index	Part No. pivoting	Part No. locking	C-profile option [mm]
.05.	28280/77280	29280/78280	.05.12.C 50	.23.	28280	29280	.23.12.C 225
.06.	28280	29280	.06.12.C 68	.237.	28280	29280	.237.12.C 237
.07.	28280/77280	29280/78280	.07.12.C 75	.25.	28280/77280	29280/78280	.25.12.C 250
.087.	28280	29280	.087.12.C 87	.262.	28280	29280	.262.12.C 262
.10.	28280/77280	29280/78280	.10.12.C 100	.28.	28280	29280	.28.12.C 275
.11.	28280/77280	29280/78280	.11.12.C 108	.29.	28280	29280	.29.12.C 287
.112.	28280	29280	.112.12.C 112	.30.	28280/77280	29280/78280	.30.12.C 300
.12.	28280/77280	29280/78280	.12.12.C 125	.312.	28280	29280	.312.12.C 312
.137.	28280	29280	.137.12.C 137	.325.	28280	29280	.325.12.C 325
.15.	28280/77280	29280/78280	.15.12.C 150	.337.	28280	29280	.337.12.C 337
.162.	28280	29280	.162.12.C 162	.350.	28280	29280	.350.12.C 350
.17.	28280/77280	29280/78280	.17.12.C 168	.362.	28280	29280	.362.12.C 362
.18.	28280	29280	.18.12.C 175	.375.	28280	29280	.375.12.C 375
.187.	28280	29280	.187.12.C 187	.387.	28280	29280	.387.12.C 387
.20.	28280/77280	29280/78280	.20.12.C 200	.400.	28280	29280	.400.12.C 400
.212.	28280	29280	.212.12.C 212				

Full set, for both ends:

28280.05.12

Single-part order:

28280.05.1

Mounting bracket with bore

28280.05.1.2

Mounting bracket with pin

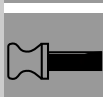



**Option steel - pivoting**

- For pivoting connections
- One part (two-piece) for all chain widths
- Electrically conductive

Moving end  
28280.1

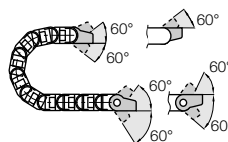

Fixed end  
28280.2

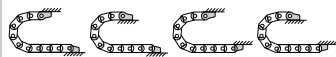

Possible installation conditions -

Further installation angles ► installation sketch

Phone +49- (0) 22 03-96 49-800  
Fax +49- (0) 22 03-96 49-222

igus® GmbH  
51147 Cologne

Internet: [www.igus.de](http://www.igus.de)  
E-mail: [info@igus.de](mailto:info@igus.de)

Moving end  
28280.1

Fixed end  
28280.2

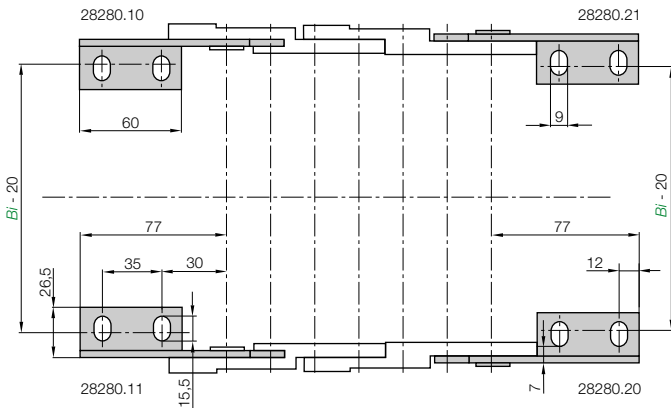

For E-Chain®	Part No. full set	Bi [mm]	For E-Chain®	Part No. full set	Bi [mm]
2828-2928-7728.05 ►	28280.12	50	2828-2928.23 ►	28280.12	225
2828-2928.06 ►	28280.12	68	2828-2928.237 ►	28280.12	237
2828-2928-7728.07 ►	28280.12	75	2828-2928-7728.25 ►	28280.12	250
2828-2928.087 ►	28280.12	87	2828-2928.262 ►	28280.12	262
2828-2928-7728.10 ►	28280.12	100	2828-2928.28 ►	28280.12	275
2828-2928-7728.11 ►	28280.12	108	2828-2928.29 ►	28280.12	287
2828-2928.112 ►	28280.12	112	2828-2928-7728.30 ►	28280.12	300
2828-2928-7728.12 ►	28280.12	125	2828-2928.312 ►	28280.12	312
2828-2928.137 ►	28280.12	137	2828-2928.325 ►	28280.12	325
2828-2928-7728.15 ►	28280.12	150	2828-2928.337 ►	28280.12	337
2828-2928.162 ►	28280.12	162	2828-2928.350 ►	28280.12	350
2828-2928-7728.17 ►	28280.12	168	2828-2928.362 ►	28280.12	362
2828-2928.18 ►	28280.12	175	2828-2928.375 ►	28280.12	375
2828-2928.187 ►	28280.12	187	2828-2928.387 ►	28280.12	387
2828-2928-7728.20 ►	28280.12	200	2828-2928.400 ►	28280.12	400
2828-2928.212 ►	28280.12	212			

28280.12 Full set, 4 parts

2 with pin / 2 with bore

Single-part order:

28280.1 Mounting bracket with bore, 1 part left / right

28280.2 Mounting bracket with pin, 1 part left / right

Other strain relief elements

► chapter 10

**Chainfix clamps for the C-profile**

Part No. single clamps		Part No. double clamps		Part No. triple clamps		Cable
steel	stainless steel	steel	stainless steel	steel	stainless steel	ø [mm]
CFX12.1	CFX12.1.E	CFX12.2	CFX12.2.E	CFX12.3	-	06 - 12
CFX14.1	CFX14.1.E	CFX14.2	CFX14.2.E	CFX14.3	-	12 - 14
CFX16.1	CFX16.1.E	CFX16.2	CFX16.2.E	CFX16.3	-	14 - 16
CFX18.1	CFX18.1.E	CFX18.2	CFX18.2.E	CFX18.3	-	16 - 18
CFX20.1	CFX20.1.E	CFX20.2	CFX20.2.E	CFX20.3	-	18 - 20
CFX22.1	CFX22.1.E	CFX22.2	CFX22.2.E	CFX22.3	-	20 - 22
CFX26.1	CFX26.1.E	CFX26.2	CFX26.2.E	-	-	22 - 26
CFX30.1	CFX30.1.E	CFX30.2	CFX30.2.E	-	-	26 - 30
CFX34.1	CFX34.1.E	CFX34.2	CFX34.2.E	-	-	30 - 34
CFX38.1	CFX38.1.E	-	-	-	-	34 - 38
CFX42.1	CFX42.1.E	-	-	-	-	38 - 42



igus® Chainfix steel clamps and Chainfix stainless-steel clamps - max. pull forces, adjustable with hexagon socket. Available as single, double or triple clamps.

**Details ▶ chapter 10**

System E4/4  
Inner height: 32 mm

Cable ø [mm]	Part No. clamp	Part No. bottom part
04 - 08	CFC-08-M	CFC-08-C
08 - 12	CFC-12-M	CFC-12-C
12 - 16	CFC-16-M	CFC-16-C
16 - 20	CFC-20-M	CFC-20-C
20 - 24	CFC-24-M	CFC-24-C

**Chainfix Clip - Modular snap-on strain relief device for C-profile**

Available for all igus® E-ChainSystems® with C-profiles and also suitable for assembly in the KMA mounting brackets and clip-on strain relief for crossbars. High pull forces, plug-in modular snap-on strain relief device. **Details ▶ chapter 10**



Part No.	ø max. conduit [mm]	Width [mm]
CFN.20	20	10,8

**Chainfix Nugget for the C-Profile**

Strain relief for the fixation of cables up to a diameter of Ø 20 mm. Easy to assemble, without any screws and tools. Easy strain relief due to fixation with pre-harnessed cable strap, very small space requirement. **Details ▶ chapter 10**



Part No.	Width of strain relief [mm]	Number of teeth
3050.ZC	50	5
3075.ZC	75	7

**Chainfix tiwrap plates with clip-on connection for the C-profile**

Can be plugged into the KMA C-profile. Easy to assemble without any screws. Easily solvable with screwdriver nevertheless safe stop. For all E-Chains® with KMA and integrated C-profile. **Details ▶ chapter 10**

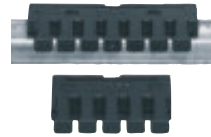

Tiwrap plate	No. of teeth n	Dim. C [mm]	Dim. B [mm]	Center bore
3050.ZB	5	50	30	-
3075.ZB	7	75	55	-
3100.ZB	10	100	80	-
3115.ZB	11	115	95	-
3125.ZB	12	125	105	-
3150.ZB	15	150	130	-
3175.ZB	17	175	155	-
3200.ZB	20	200	180	+
3225.ZB	22	225	205	+
3250.ZB	25	250	230	+

(- = no / + = yes)

**Tiwrap plate as individual part**

As individual component screwed on KMA. Can be plugged in the mounting brackets. **Details ▶ chapter 10**

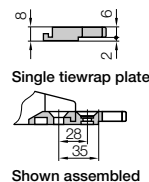
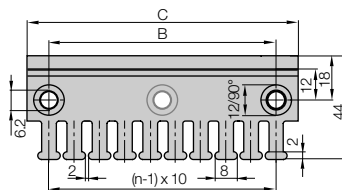

Details about all strain relief option for this series ▶ chapter 10

Phone +49- (0) 22 03-96 49-800  
Fax +49- (0) 22 03-96 49-222



▶ page 7.91

- $B_a$  = Outer width E-Chains® / E-Tube
- $B_i$  = Inner width E-Chains® / E-Tube
- $h_a$  = Outer height E-Chains® / E-Tube
- $H_{Ri}$  = Inner trough height
- $H_{Ra}$  = Outer trough height
- $B_{Ri}$  = Inner trough width ▶ depends on dim.  $B_a$
- $B_{Ra}$  = Outer trough width
- $n_{Mon}$  = Number of installation sets (left/right)
- $n_{Ri}$  = Number of troughs sets (left/right)
- $H_{Ri} \geq 2 \cdot h_a$
- $B_{Ri} \geq B_a + 4$
- = Guide trough set    ● = Glide bar
- = Installation set "Basic"    ● = C-profile

### Installation set "Basic" with C-profile

Bottom Clamp attached optionally inwards or outwards

2828.05.200.0 ▶ Order example

	$B_{Ri}$ [mm]	Part No.	
		attached inwards	attached outwards
.05	78	960.30.125	960.30.175
.06	96	960.30.150	960.30.200
.07	103	960.30.150	960.30.200
.087	115	960.30.175	960.30.225
.10	128	960.30.175	960.30.225
.11	136	960.30.200	960.30.225
.112	141	960.30.200	960.30.250
.12	153	960.30.200	960.30.250
.137	166	960.30.225	960.30.275
.15	178	960.30.225	960.30.275
.162	191	960.30.250	960.30.300
.17	196	960.30.250	960.30.300
.18	203	960.30.250	960.30.300
.187	216	960.30.275	960.30.325
.20	228	960.30.275	960.30.325
.212	241	960.30.300	960.30.350
.23	253	960.30.300	960.30.350
.237	266	960.30.325	960.30.375
.25	278	960.30.325	960.30.375
.262	291	960.30.350	960.30.400
.28	303	960.30.350	960.30.400
.29	316	960.30.375	960.30.425
.30	328	960.30.375	960.30.425
.312	341	960.30.400	960.30.450
.325	353	960.30.400	960.30.450
.337	366	960.30.425	960.30.475
.350	378	960.30.425	960.30.475
.362	391	960.30.450	960.30.500
.375	403	960.30.450	960.30.500
.387	416	960.30.475	960.30.525
.400	428	960.30.475	960.30.525

Insert for the installation set "Heavy-Duty": **972.50.XXX** instead of **960.30.XXX** on the right column "attached outwards"

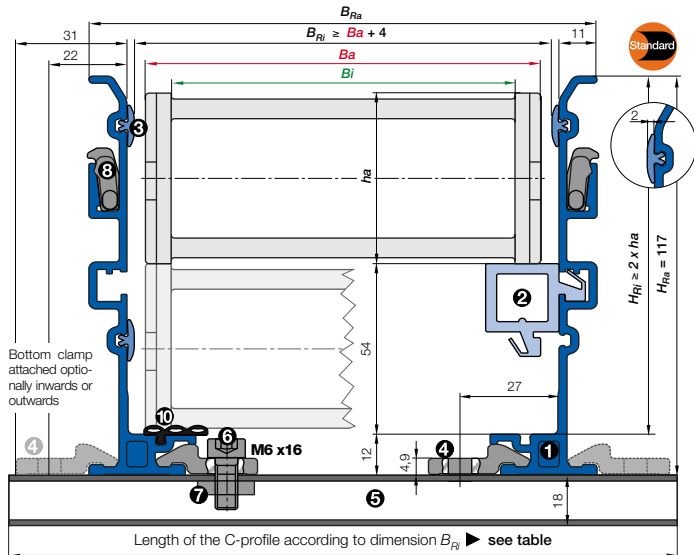

- Components, trough "Basic": ① Trough side parts, aluminum, 2 m ② Glide bar, plastic, 2 m ③ Glide strips, plastic, 2 m (without glide strips on request) ⑩ Optional: Silencer profile, rubber
- Components, installation set "Basic": ④ Bottom clamp, aluminum ⑤ C-profile, steel galvanized ⑥ Screw M6 x16 ⑦ Sliding nut M6 ⑧ Interface connector, plastic



### Order example: Length of travel 30 m - Center mounted for Series 2828.30.300.0 with $B_{Ri} = 328$

- Guide trough set (set of 2 trough side parts, incl. glide strips) **without** glide bar  
Order text: 16 m guide trough without glide bar (8 x 2 m sections) **Part No. 972.30.SL**
- Guide trough set (set of 2 trough side parts, incl. glide strips) **with** glide bar  
Order text: 16 m guide trough with glide bar (8 x 2 m sections) **Part No. 972.31.SL**
- Installation set "Basic" complete (guide trough-sets + 1)  
Order text: 17 installation sets "Basic" **Part No. 960.30.150**
- Module for the fixed end  
Order text: 1 set **Part No. 972.80**
- Option: For an additional noise dampening with silencer profile, please add Index A - Example: **Part No. 972.30.SLA**

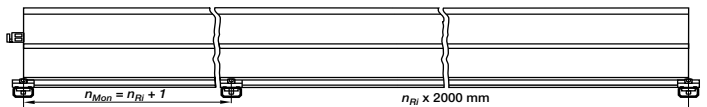

Principle sketch: Number of installation sets to be installed = Number of trough sections + 1

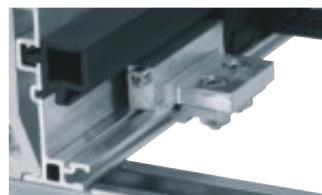

### NEW! A quick fix for mounting the stationary end of an E-Chain®

With this new module for the fixed end, fast and easy mounting onto the Aluminum "SuperTrough" is now possible without any drilling. Fast mounting of the E-Chain" by clamping onto the aluminum trough ● Quick relocation of the stationary end ● No drilling necessary ▶ page 9.16

Phone +49- (0) 22 03-96 49-800  
Fax +49- (0) 22 03-96 49-222

igus® GmbH  
51147 Cologne

Internet: www.igus.de  
E-mail: info@igus.de

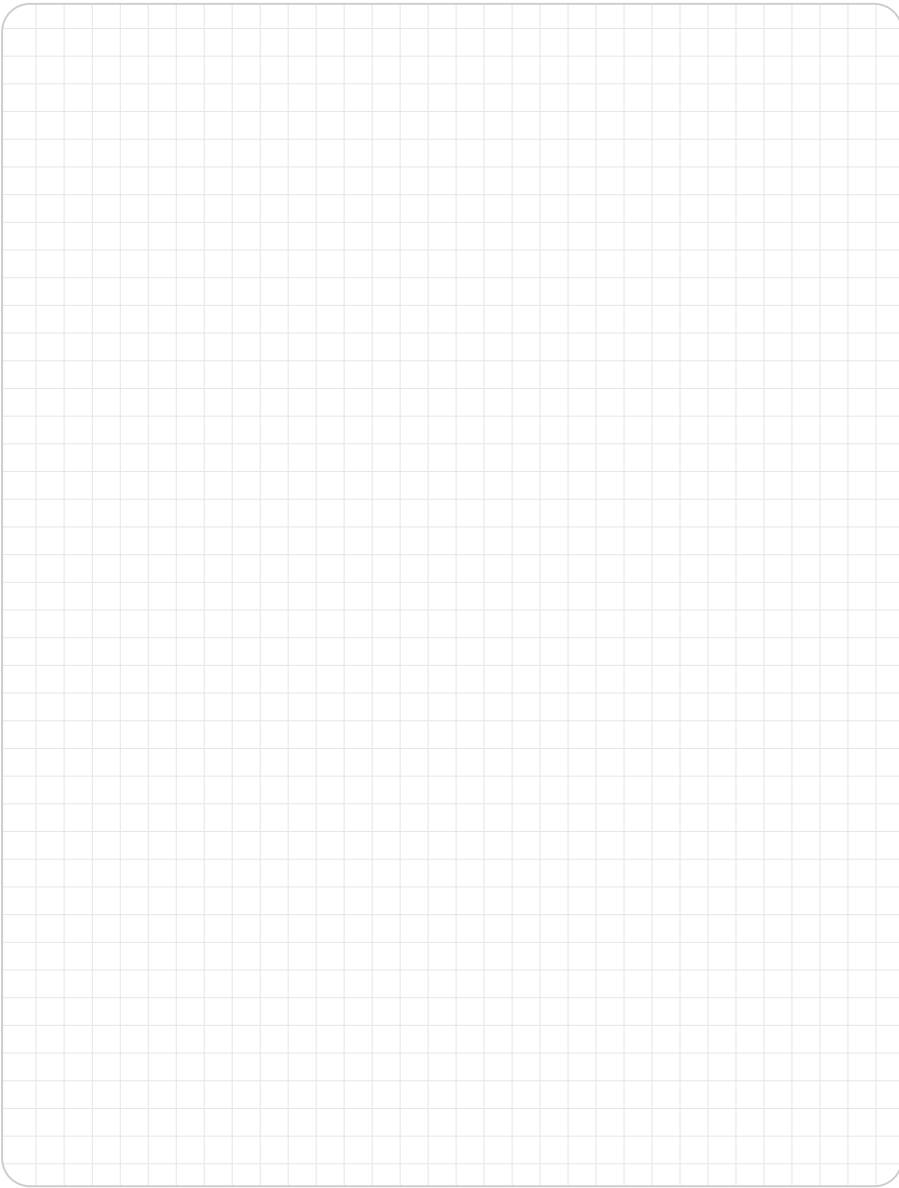

System E4/4  
Inner height: 32 mm

Phone +49- (0) 22 03-96 49-800  
Fax +49- (0) 22 03-96 49-222



▶ Chapter 9



▶ page 7.91

## TPE-Power cable for high dynamic - Chainflex® CF35

TIP!

TPE-Outer jacket, oil- and bio-oil-resistant, flame retardant, shielded  
Further information: [www.igus.de/en/CF35](http://www.igus.de/en/CF35)

IGUS® CHAINFLEX® CF35

Price index



Side-mounted -  
unsupported



ESD classification:  
Electrically conductive ESD/ATEX  
version upon request



High torsional  
rigidity



Opening E-Chains®: Remove crossbars and clips - Insert screwdriver into the slot, push down, release by lever action



Remove lids/bottoms (E-Tubes) - Insert screwdriver into the slot, release by lever action



When to use the Series 3838/3938/R7838:

- When high torsional or shearing forces are expected
- For side-mounted applications involving large unsupported lengths
- For long-term operation in very moist environments
- Also available as Rol E-Chain®



When not to use it:

- If a quieter version is required  
▶ Series 380/390/ R780, page 7.36
- For increased inner height of 52 mm  
▶ Series 383822, page 12.44

- 1 High side-mount stability due to tongue and groove
- 2 High torsional rigidity
- 3 Closed and open styles can be combined
- 4 Hinged snap-open removable lids along outer radius of E-Tube
- 5 Removable lids along inner radius
- 6 Crossbars on E-Chains® are removable along both radii
- 7 Lateral glide surfaces for side-mounted operation
- 8 Wide, rounded plastic crossbars - cable friendly
- 9 KMA mounting brackets with attachment points on all sides
- 10 Locking or pivoting mounting brackets available
- 11 E-Chain® also available with reverse bending radii



Rol E-Chain® Series  
3838R/7838R available  
upon request

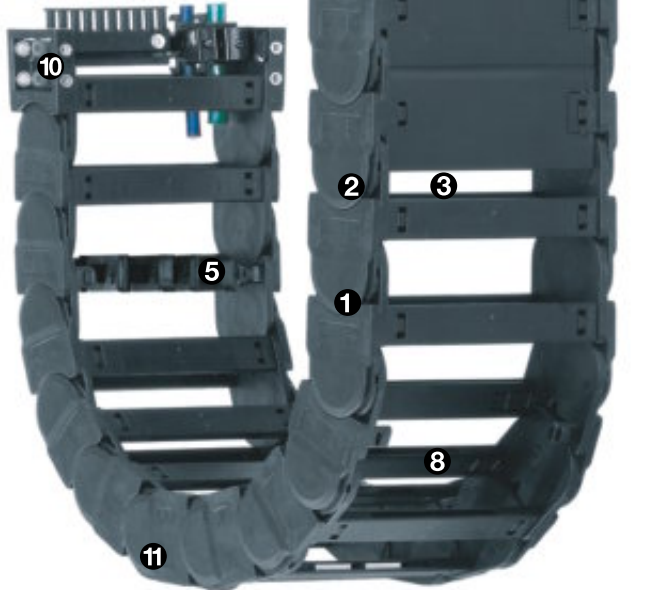

Order example complete E-Chain®

Please indicate chain-lengths or number of links Example: 4 m or 60 links

4 m 3838.30.300.0



E-Chain®

with 2 separators 382 assembled every 2<sup>nd</sup> link



Interior separation

1 set 38380.30.12C



Mounting bracket



### Unsupported length

$FL_G$  = with straight upper run

$FL_B$  = with permitted sag

Further information ► Design, page 1.12

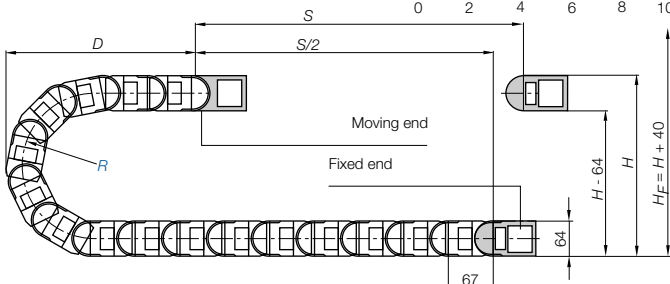
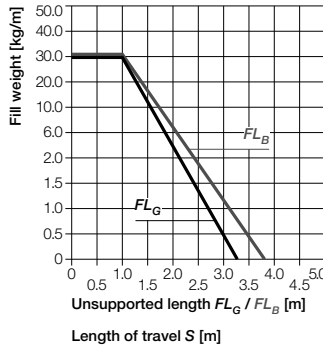
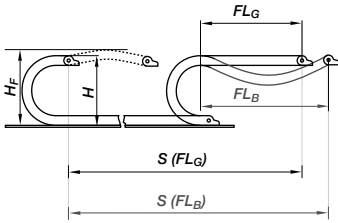

Pitch = 67 mm/link    Links/m = 15 (1005 mm)    Chain length =  $S/2 + K$

R	075	100	115	125	150	170	200	215	250	300	350
$H_{25}^{+0.25}$	215	265	295	315	365	405	465	495	565	665	765
D	174	199	214	224	249	269	299	314	349	399	449
K	370	450	500	530	610	670	765	810	920	1080	1235
$D_2^{+25}$	-	-	435	475	570	690	780	865	1010	1150	1500
$K_2$	-	-	737	804	1005	1139	1340	1407	1675	1943	2412
$H_2$	-	-	186	186	186	186	186	186	186	186	186

- S = Length of travel
  - R = Bending radius
  - H = Nominal clearance height
  - $H_F$  = Required clearance height
  - $H_{in}$  = Trough inner height
  - D = Overlength E-Chain" radius in final position
  - $K = \pi \cdot R + \text{"safety"}$
  - $D_2$  = Over length - long travels, gliding
  - $K_2$  = "Further add-on
  - $H_2$  = "Mounting height
- \*if the mounting bracket location is set lower

### Other installation methods

- Vertical, hanging  $\leq 100$  m
- Vertical, standing  $\leq 6$  m
- Side mounted, un supp.  $\leq 2,5$  m
- Rotary requires further calculation
- Unsupported length of upper run = upon request

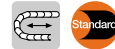

### Short travels - unsupported

Unsupported E-Chains® feature positive camber over short travels. This must be accounted for when specifying the clearance height  $H_F$ . Please consult igus® if space is particularly restricted.

The required clearance height:  
 $H_F = H + 40$  mm  
(with 2,0 kg/m fill weight)

### Long travel lengths from 10 m to max. 280 m    Chain length = $S/2 + K_2$

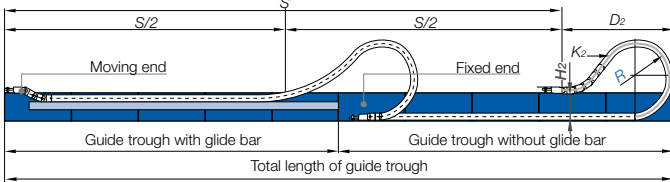

In case of travels between 4 and 10 m we recommend a longer unsupported length.



### Gliding, long travel applications (max. 280 m)

In this case the E-Chain® upper run will be introduced in a guide trough on the lower run. We recommend to realize the engineering of such a plant by our technicians.

Speed / acceleration $FL_G$	max. 20 [m/s] / max. 200 [m/s <sup>2</sup> ]
Speed / acceleration $FL_B$	max. 3 [m/s] / max. 6 [m/s <sup>2</sup> ]
Gliding speed / acceleration (maximum)	max. 10 [m/s] / max. 50 [m/s <sup>2</sup> ]
Material - permitted temperature °C	igumid G / -40° up to +120° C
Flammability class, igumid G	VDE 0304 IIC UL94 HB

### Technical Data



Details of material properties  
► page 1.38

42

System E4/4  
Inner height: 42 mm

Phone +49- (0) 22 03-96 49-800  
Fax +49- (0) 22 03-96 49-222



► page 7.91

igus® E-ChainSystems®

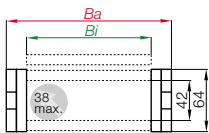

Part No. structure

3838. 400. 300. 0



Series 3838 - E-Chain® with crossbars every link

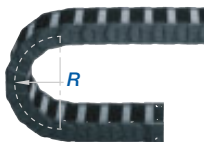

- Crossbars every link
- For rigid hydraulic hoses
- For applications particularly demanding
- Can be opened from two sides



Phone +49- (0) 22 03-96 49-800  
Fax +49- (0) 22 03-96 49-222

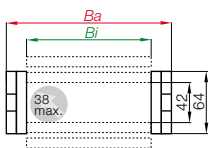

Part No. structure

3938. 400. 300. 0



Series 3938 - E-Chain® with crossbars every 2<sup>nd</sup> link

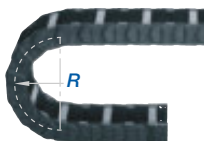

- Crossbars every 2<sup>nd</sup> link = Standard
- For nearly every situation
- Can be opened from two sides
- Easy assembly
- Stable
- Attractive price



igus® GmbH  
51147 Cologne

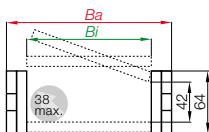

Part No. structure

7838. 25. 300. 0



Series R7838 - Fully enclosed E-Tube

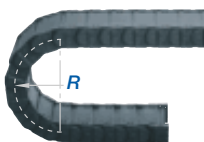

- Fully enclosed
- Excellent cable protection against dirt
- Protection against hot chips (up to 900°C)
- Lids along the entire inner radius are completely removable. Lids along the entire outer radius are single sided snap-open with a hinge on the other side to keep them attached to the chain or completely removable.



Internet: [www.igus.de](http://www.igus.de)  
E-mail: [info@igus.de](mailto:info@igus.de)

Rol instead of gliding: Rol E-Chain®

Special solution for long travels. 75% less drive power (gliding application) with igus® Rol E-Chain®.

Series 3838R - Order example - 3838R.30.250.0

Further information: [www.igus.de/en/rol](http://www.igus.de/en/rol)  
or phone: +49-0 22 03-96 49-800



TIP!

Part No.	Bi [mm]	Ba [mm]	3838 [kg/m]	3938 [kg/m]	R7838 [kg/m]
3838/3938/7838.05. [ ] .0*	50	77	≈ 2,06	≈ 1,98	≈ 2,25
3838/3938.06. [ ] .0	68	95	≈ 2,09	≈ 1,99	-
3838/3938/7838.07. [ ] .0	75	102	≈ 2,12	≈ 2,01	≈ 2,38
3838/3938.087. [ ] .0	87	115	≈ 2,18	≈ 2,04	-
3838/3938/7838.10. [ ] .0	100	127	≈ 2,25	≈ 2,08	≈ 2,60
3838/3938/7838.11. [ ] .0	108	135	≈ 2,30	≈ 2,10	≈ 2,65
3838/3938.112. [ ] .0	112	140	≈ 2,30	≈ 2,10	-
3838/3938/7838.12. [ ] .0	125	152	≈ 2,40	≈ 2,15	≈ 2,81
3838/3938.137. [ ] .0	137	165	≈ 2,44	≈ 2,17	-
3838/3938/7838.15. [ ] .0	150	177	≈ 2,53	≈ 2,21	≈ 3,07
3838/3938.162. [ ] .0	162	190	≈ 2,55	≈ 2,22	-
3838/3938/7838.17. [ ] .0	168	195	≈ 2,62	≈ 2,26	≈ 3,24
3838/3938.18. [ ] .0	175	202	≈ 2,62	≈ 2,26	-
3838/3938.187. [ ] .0	187	215	≈ 2,69	≈ 2,30	-
3838/3938/7838.20. [ ] .0	200	227	≈ 2,77	≈ 2,33	≈ 3,53
3838/3938.212. [ ] .0	212	240	≈ 2,84	≈ 2,37	-
3838/3938.23. [ ] .0	225	252	≈ 2,92	≈ 2,41	-
3838/3938.237. [ ] .0	237	265	≈ 2,96	≈ 2,43	-
3838/3938/7838.25. [ ] .0	250	277	≈ 3,05	≈ 2,47	≈ 4,33
3838/3938.262. [ ] .0	262	290	≈ 3,06	≈ 2,48	-
3838/3938.28. [ ] .0	275	302	≈ 3,17	≈ 2,53	-
3838/3938.29. [ ] .0	287	315	≈ 3,19	≈ 2,54	-
3838/3938/7838.30. [ ] .0	300	327	≈ 3,32	≈ 2,61	≈ 4,89
3838/3938.312. [ ] .0	312	340	≈ 3,34	≈ 2,62	-
3838/3938.325. [ ] .0	325	352	≈ 3,41	≈ 2,66	-
3838/3938.337. [ ] .0	337	365	≈ 3,46	≈ 2,68	-
3838/3938.350. [ ] .0	350	377	≈ 3,68	≈ 2,79	-
3838/3938.362. [ ] .0	362	390	≈ 3,74	≈ 2,82	-
3838/3938.375. [ ] .0	375	402	≈ 3,79	≈ 2,84	-
3838/3938.387. [ ] .0	387	415	≈ 3,85	≈ 2,87	-
3838/3938.400. [ ] .0	400	427	≈ 3,90	≈ 2,90	-

Available bending radii

R [mm] 075\*\* 100\*\* 115\*\* 125 150 170 200 215 250 300 350

Supplement Part No. with required radius. Example: 3838.400.[300].0

0 = standard color, other colors ▶ page 1.39 · Pitch = 67 mm/link · Links/m = 15

\*Removable lid only, no hinged option · \*\*not available for R7838

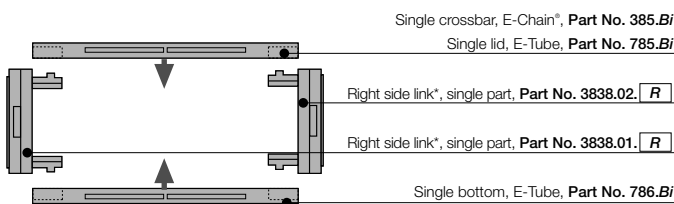

**TIP!**  
**Hot Chips up to 850°C**  
 E-Tubes that repel hot chips, up to 850 °C  
 Some applications, depending on amount and size of the chips, can burn or melt the surface. That is no longer the case with the new igus® "igumid HT" material.  
 Further information: [www.igus.de/en/HT](http://www.igus.de/en/HT) or phone: +49-0 22 03-96 49-800

**TIP!**  
**igus® Line Extension**  
 Increased inner height 52 mm  
 The Series Part No. 383822 E-Chain\*, with an increased inner height of 52 mm, is available for unsupported applications  
 ▶ page 12.44

**i**  
 Extender crossbar for large diameter hoses ▶ page 7.102

**Part No. E-Chain®-links, single parts**  
 \*View from the fixed point of the E-Chain\*/E-Tube

System E4/4  
 Inner height: 42 mm

Phone +49- (0) 22 03-96 49-800  
 Fax +49- (0) 22 03-96 49-222



▶ page 7.91



**Option 1**

- Vertical separators
- Spacers
- Locking separators
- Asymmetric separators

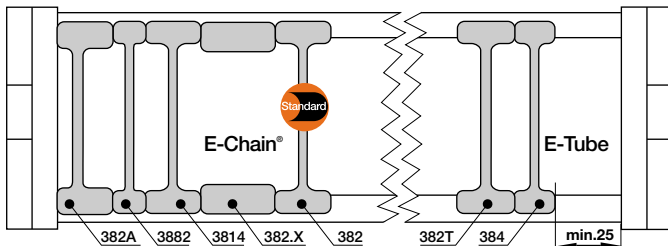

Vertical separator  
381

Vertical separator for E-Chains®	2,5
unassembled	381
assembled	382



Vertical separator  
with a narrow base  
3881

Vertical separator for E-Chains®	2,5
unassembled	3881
assembled	3882



Vertical separator  
381T

Vertical separator for E-Tubes	3
unassembled	381T
assembled	382T



Spacer  
381.10

Spacer* for E-Chains®	10
unassembled	381.10
assembled	382.10



Spacer  
381.15

Spacer* for E-Chains®	16
unassembled	381.15
assembled	382.15



Spacer  
381.20

Spacer* for E-Chains®	20
unassembled	381.20
assembled	382.20



Locking separator  
3804

Locking separator for E-Chains®	2,5
unassembled	3804
assembled	3814



Locking separator  
383

Locking separator for E-Tubes	2,5
unassembled	383
assembled	384



Asymmetric  
separator 381A

Asymmetric separator for E-Chains®	2,5
unassembled	381A
assembled	382A



\*For side-mounted applications

**Option 1: Vertical separators and spacers**

Vertical separators are used if a vertical subdivision of the E-Chain® interior is required - By standard vertical separators are assembled every other E-Chain® link. **Note:** Observe a lateral spacing of at least 25 mm for E-Tubes!

● **Standard separator 381 for E-Chains®** offers safe stability due to its wide base design, also when used with thick cables or hoses.

● **Vertical separator 3881 with a narrow base (7 mm) for E-Chains®** with applications where a large number of small cables need to be individually separated.

● **Vertical separator 381T for E-Tubes** clamps to the fixed radius and remains free along the other radius to facilitate lid removal. If installing these yourself, please ensure that they are identically aligned.

● Vertical separators in side-mounted applications, for instance, can be fixed in position by means of **spacer 381.X for E-Chains®**. A wide range of intervals between the vertical separators is adjustable here.

● **Note on spacers:** The available interior height is reduced by 2 mm per spacer (4 mm when spacers are fitted on both sides). To avoid this, the parts can also be installed from the outside on the opening crossbar.

**Additionally:**

● **Locking separator 3804 for E-Chains®** - with increased retention force for applications exposed to very high humidity or extreme loads. The extra retention force is achieved by asymmetric claws for the crossbar. Ensure proper alignment.

● **Locking separator 383 for E-Tubes** - This vertical separator is suitable for use in extremely moist environments.

● **Asymmetric separator 381A for E-Chains®** (not for E-Tubes) with an 14-mm base, for combinations between spacers of different widths and vertical separators in side-mounted applications, for instance.

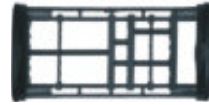
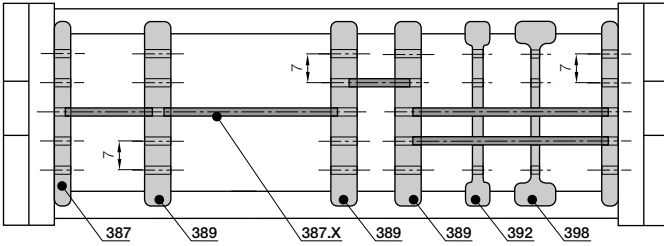

**Option 2**

- Side plates
- Middle plates
- Slotted separators
- Open slotted separators

**Option 2: Shelves**

For applications involving many cables with different diameters. The shelves can be arranged elevator-shifted with different bottoms.

- Side plates 386, middle plates 388 and shelves 386.X from the basic pattern of a shelf system. Shelves of various widths can be arranged at 5 different heights (in 7 mm increments).

- Slotted separators 391 are used for very fine subdivisions. However, they cannot be retrofitted into an existing separation system without dismantling the interior separators first.

- The unilateral open slotted separator 397 can be retrofitted into an existing interior separation system without a need for dismantling the interior separators. During an installation of open slotted separators, the top and bottom notches cannot be occupied by shelves.



Side plate for E-Chains®/E-Tubes		
unassembled	386	
assembled		387



Middle plate for E-Chains®/E-Tubes		
unassembled	388	
assembled		389



Slotted separator for E-Chains®/E-Tubes		
unassembled	391	
assembled		392



Open slotted separator for E-Chains®/E-Tubes		
unassembled	397	
assembled		398

Width X [mm]	Part No. unassembled	Part No. assembled
18	386.18	387.18
23	386.23	387.23
25	386.25	387.25
28	386.28	387.28
33	386.33	387.33
43	386.43	387.43
50	386.50	387.50
54	386.54	387.54
62	386.62	387.62

Width X [mm]	Part No. unassembled	Part No. assembled
75	386.75	387.75
87	386.87	387.87
100	386.100	387.100
108	386.108	387.108
125	386.125	387.125
150	386.150	387.150
175	386.175	387.175
200	386.200	387.200
208	386.208	387.208



Side plate 386



Middle plate 388



Slotted separator 391



Open slotted separator 397



Shelf 386.X

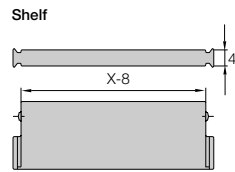

Shelf

System E4/4  
Inner height: 42 mm

Phone +49- (0) 22 03-96 49-800  
Fax +49- (0) 22 03-96 49-222





### Extension links - for extremely wide E-Chains® up to 3,0 m

- For applications in which particularly high fill weights necessitate extremely wide E-Chains® (up to 3000 mm)
- The extension link design allows virtually limitless side-by-side attachment of chains
- The unsupported length of a chain can be increased when additional loads are required
- Extension links can be used with E-Chains®, E-Tubes or as a combination of both
- They are suitable for unsupported and gliding applications in a guide trough
- E-Chains® with extension links are attached with KMA or steel mounting brackets



Part No. structure  
3838.10 /20 /10. 200.0  
3838.Bi1/Bi2/Bi3. R 1.0

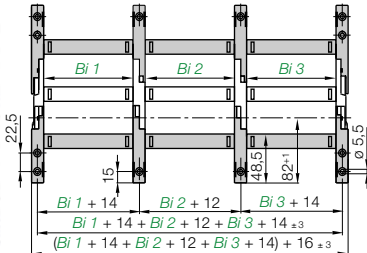

### Extender crossbars - careful guide of hoses applications

- Suitable for hoses with a maximum outer diameter of 115 mm
- Gliding operation with crossbars assembled along the outer radius and a special guide trough
- Gliding operation not guaranteed with crossbars assembled along the inner radius
- The extender crossbar can either be attached to the side links directly or can be used in combination with two stranded snap-open crossbars

Consult igus® for your extender crossbar applications. We are happy to assist you with your design layout

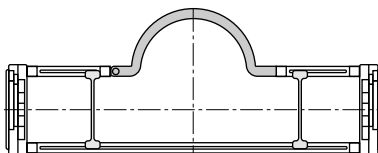

385.15RHD115 round extender crossbar combined with snap-open crossbars

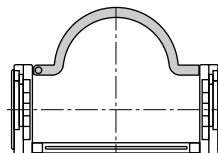

385.18RD115 round strap assembled directly on the side section

Part No.	Max Ø [mm]	Form	Installation side link	Combination with snap-open crossb.
	hose			
385.15.RHD115	115	○	-	+
385.18.RD115	115	○	+	-

○ = round + = yes / - = no



### Hinged crossbars

- Typically E-Chain® crossbars are completely removable. In cases where the snap-open crossbars have to remain at the open link of the E-Chain®, a hinged design has been developed
- Length: 37,5 mm **Part No. 385.02** / snap-open crossbar (shortened): Bi-37,5 mm **Part No. 385.03**
- Please consult igus® for design assistance

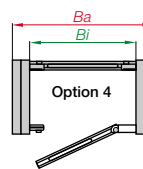
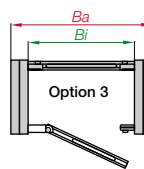
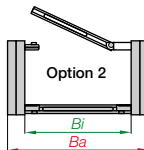
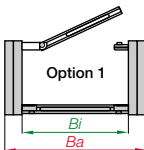
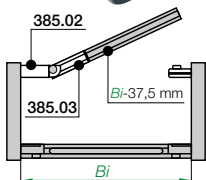

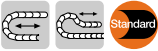

### The Standard - Option KMA\* - pivoting

- Recommended for unsupported and gliding applications
- Confined installation conditions
- Option - integrated C-profile strain relief device with Chainfix clip or strain relief tiwrap plates
- Corrosion resistant
- Universal mountable with attachment capability on all sides

\*KMA = Polymer Metal Mounting Bracket

Moving end  
38380/78380...1

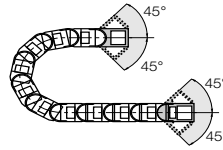

Fixed end  
38380/78380...2



The attachment variants arising automatically by the choice of the KMA mounting bracket

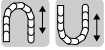
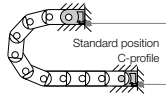

### Option KMA - locking

- Recommended for vertical hanging / standing applications

**Additionally:**

- Universal mountable
- C-profile option
- Corrosion resistant
- Locked connections
- At very high acceleration

Moving end  
39380/79380...1

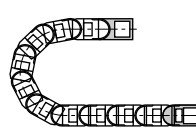

Fixed end  
39380/79380...2



The attachment variants arising automatically by the choice of the KMA mounting bracket

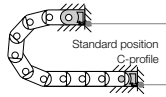

Fixed end 38380/78380...2 (pivoting) 39380/79380...2 (locking) Moving end (pivoting) 38380/78380...1 (locking) 39380/79380...1

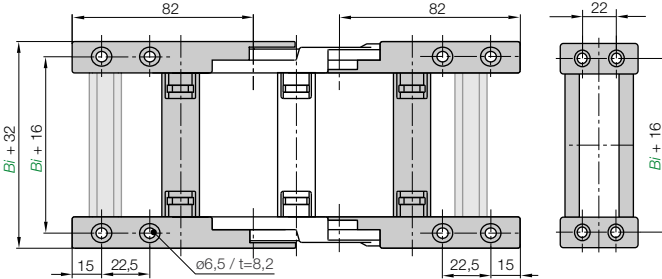

Width index	Part No. pivoting	Part No. locking	C-profile option [mm]	Width [mm]	Part No. pivoting	Part No. locking	C-profile option [mm]	Width [mm]
.05.	38380/78380	39380/79380	.05.12 [C] 50	23.	38380	39380	.23.12 [C] 225	23.
.06.	38380	39380	.06.12 [C] 68	.237.	38380	39380	.237.12 [C] 237	.237.
.07.	38380/78380	39380/79380	.07.12 [C] 75	.25.	38380/78380	39380/79380	.25.12 [C] 250	.25.
.087.	38380	39380	.087.12 [C] 87	.262.	38380	39380	.262.12 [C] 262	.262.
.10.	38380/78380	39380/79380	.10.12 [C] 100	.28.	38380	39380	.28.12 [C] 275	.28.
.11.	38380/78380	39380/79380	.11.12 [C] 108	.29.	38380	39380	.29.12 [C] 287	.29.
.112.	38380	39380	.112.12 [C] 112	.30.	38380/78380	39380/79380	.30.12 [C] 300	.30.
.12.	38380/78380	39380/79380	.12.12 [C] 125	.312.	38380	39380	.312.12 [C] 312	.312.
.137.	38380	39380	.137.12 [C] 137	.325.	38380	39380	.325.12 [C] 325	.325.
.15.	38380/78380	39380/79380	.15.12 [C] 150	.337.	38380	39380	.337.12 [C] 337	.337.
.162.	38380	39380	.162.12 [C] 162	.350.	38380	39380	.350.12 [C] 350	.350.
.17.	38380/78380	39380/79380	.17.12 [C] 168	.362.	38380	39380	.362.12 [C] 362	.362.
.18.	38380	39380	.18.12 [C] 175	.375.	38380	39380	.375.12 [C] 375	.375.
.187.	38380	39380	.187.12 [C] 187	.387.	38380	39380	.387.12 [C] 387	.387.
.20.	38380/78380	39380/79380	.20.12 [C] 200	.400.	38380	39380	.400.12 [C] 400	.400.
.212.	38380	39380	.212.12 [C] 212					

### Dimensions and order configurations

**Part No. structure (pivoting)**

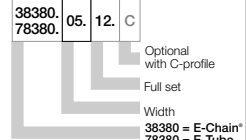

**Part No. structure (locking)**

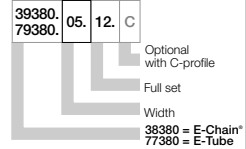

Full set, for both ends:

38380.05.12

Single-part order:

38380.05.1

Mounting bracket with bore

38380.05.1.2

Mounting bracket with pin

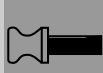



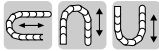

**Option steel - pivoting**

- For pivoting connections
- One part (two-piece) for all chain widths
- Electrically conductive

Moving end  
38380.1

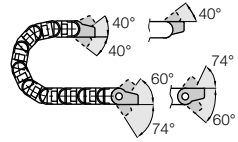

Fixed end  
38380.2

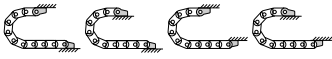

Possible installation conditions -

Further installation angles ► installation sketch

Moving end  
38380.1

Fixed end  
38380.2

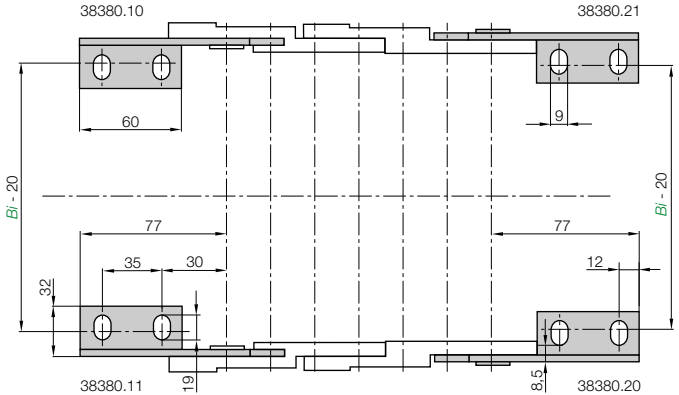

Phone +49- (0) 22 03-96 49-800  
Fax +49- (0) 22 03-96 49-222

igus® GmbH  
51147 Cologne

Internet: [www.igus.de](http://www.igus.de)  
E-mail: [info@igus.de](mailto:info@igus.de)

**38380.12** Full set, 4 parts

2 with pin / 2 with bore

**Single-part order:**

**38380.1** Mounting bracket

with bore, 1 part left / right

**38380.2** Mounting bracket

with pin, 1 part left / right

For E-Chain®	Part No.	full set	Bi [mm]	For E-Chain®	Part No.	full set	Bi [mm]
3838-3938-7838.05	▶ 38380.12		50	3838-3938.23	▶ 38380.12		225
3838-3938.06	▶ 38380.12		68	3838-3938.237	▶ 38380.12		237
3838-3938-7838.07	▶ 38380.12		75	3838-3938-7838.25	▶ 38380.12		250
3838-3938.087	▶ 38380.12		87	3838-3938.262	▶ 38380.12		262
3838-3938-7838.10	▶ 38380.12		100	3838-3938.28	▶ 38380.12		275
3838-3938-7838.11	▶ 38380.12		108	3838-3938.29	▶ 38380.12		287
3838-3938.112	▶ 38380.12		112	3838-3938-7838.30	▶ 38380.12		300
3838-3938-7838.12	▶ 38380.12		125	3838-3938.312	▶ 38380.12		312
3838-3938.137	▶ 38380.12		137	3838-3938.325	▶ 38380.12		325
3838-3938-7838.15	▶ 38380.12		150	3838-3938.337	▶ 38380.12		337
3838-3938.162	▶ 38380.12		162	3838-3938.350	▶ 38380.12		350
3838-3938-7838.17	▶ 38380.12		168	3838-3938.362	▶ 38380.12		362
3838-3938.18	▶ 38380.12		175	3838-3938.375	▶ 38380.12		375
3838-3938.187	▶ 38380.12		187	3838-3938.387	▶ 38380.12		387
3838-3938-7838.20	▶ 38380.12		200	3838-3938.400	▶ 38380.12		400
3838-3938.212	▶ 38380.12		212				

Other strain relief elements

► chapter 10

### Chainfix clamps for the C-profile

Part No. single clamps		Part No. double clamps		Part No. triple clamps		Cable
steel	stainless steel	steel	stainless steel	steel	stainless steel	ø [mm]
CFX12.1	CFX12.1.E	CFX12.2	CFX12.2.E	CFX12.3	-	06 - 12
CFX14.1	CFX14.1.E	CFX14.2	CFX14.2.E	CFX14.3	-	12 - 14
CFX16.1	CFX16.1.E	CFX16.2	CFX16.2.E	CFX16.3	-	14 - 16
CFX18.1	CFX18.1.E	CFX18.2	CFX18.2.E	CFX18.3	-	16 - 18
CFX20.1	CFX20.1.E	CFX20.2	CFX20.2.E	CFX20.3	-	18 - 20
CFX22.1	CFX22.1.E	CFX22.2	CFX22.2.E	CFX22.3	-	20 - 22
CFX26.1	CFX26.1.E	CFX26.2	CFX26.2.E	-	-	22 - 26
CFX30.1	CFX30.1.E	CFX30.2	CFX30.2.E	-	-	26 - 30
CFX34.1	CFX34.1.E	CFX34.2	CFX34.2.E	-	-	30 - 34
CFX38.1	CFX38.1.E	-	-	-	-	34 - 38
CFX42.1	CFX42.1.E	-	-	-	-	38 - 42



igus® Chainfix steel clamps and Chainfix stainless-steel clamps - max. pull forces, adjustable with hexagon socket. Available as single, double or triple clamps.

Details ► chapter 10

System E4/4  
Inner height: 42 mm

Cable ø [mm]	Part No. clamp	Part No. bottom part
04 - 08	CFC-08-M	CFC-08-C
08 - 12	CFC-12-M	CFC-12-C
12 - 16	CFC-16-M	CFC-16-C
16 - 20	CFC-20-M	CFC-20-C
20 - 24	CFC-24-M	CFC-24-C

### Chainfix Clip - Modular snap-on strain relief device for C-profile

Available for all igus® E-ChainSystems® with C-profiles and also suitable for assembly in the KMA mounting brackets and clip-on strain relief for crossbars. High pull forces, plug-in modular snap-on strain relief device. Details ► chapter 10



Part No.	ø max. conduit [mm]	Width [mm]
CFN.20	20	10,8

### Chainfix Nugget for the C-Profile

Strain relief for the fixation of cables up to a diameter of Ø 20 mm. Easy to assemble, without any screws and tools. Easy strain relief due to fixation with pre-harnessed cable strap, very small space requirement. Details ► chapter 10



Part No.	Width of strain relief [mm]	Number of teeth
3050.ZC	50	5
3075.ZC	75	7

### Chainfix tiwrap plates with clip-on connection for the C-profile

Can be plugged into the KMA C-profile. Easy to assemble without any screws. Easily solvable with screwdriver nevertheless safe stop. For all E-Chains® with KMA and integrated C-profile. Details ► chapter 10

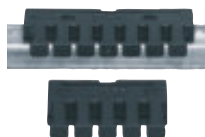

Tiewrap plate	No. of teeth n	Dim. C [mm]	Dim. B [mm]	Center bore
3050.ZB	5	50	30	-
3075.ZB	7	75	55	-
3100.ZB	10	100	80	-
3115.ZB	11	115	95	-
3125.ZB	12	125	105	-
3150.ZB	15	150	130	-
3175.ZB	17	175	155	-
3200.ZB	20	200	180	+
3225.ZB	22	225	205	+
3250.ZB	25	250	230	+

(- = no / + = yes)

### Tiewrap plate as individual part

As individual component screwed on KMA. Can be plugged in the mounting brackets. Details ► chapter 10

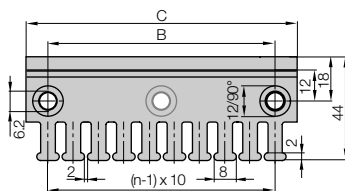

Single tiewrap plate

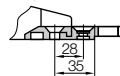

Shown assembled

Details about all strain relief option for this series ► chapter 10

Phone +49- (0) 22 03-96 49-800  
Fax +49- (0) 22 03-96 49-222



► Chapter 10



► page 7.91

- $B_a$  = Outer width E-Chains® / E-Tube
- $B_i$  = Inner width E-Chains® / E-Tube
- $h_a$  = Outer height E-Chains® / E-Tube
- $H_{Ri}$  = Inner trough height
- $H_{Ra}$  = Outer trough height
- $B_{Ri}$  = Inner trough width ▶ depends on dim.  $B_a$
- $B_{Ra}$  = Outer trough width
- $n_{Mon}$  = Number of installation sets (left/right)
- $n_{Ri}$  = Number of troughs sets (left/right)
- $H_{Ri} \geq 2 \cdot h_a$
- $B_{Ri} \geq B_a + 4$
- = Guide trough set      ● = Glide bar
- = Installation set "Basic"      ● = C-profile

### Installation set "Basic" with C-profile

Bottom Clamp attached optionally inwards or outwards

3838.05.300.0 ▶ Order example

	Part No.		Part No.	
	$B_{Ri}$ attached inwards [mm]	attached outwards	attached inwards	attached outwards
.05	81	-	960.40.200	
.06	99	-	960.40.225	
.07	106	-	960.40.225	
.087	119	960.40.175	960.40.250	
.10	131	960.40.200	960.40.250	
.11	139	960.40.200	960.40.275	
.112	144	960.40.200	960.40.275	
.12	156	960.40.225	960.40.275	
.137	169	960.40.225	960.40.300	
.15	181	960.40.250	960.40.300	
.162	194	960.40.250	960.40.325	
.17	199	960.40.250	960.40.325	
.18	206	960.40.275	960.40.325	
.187	219	960.40.275	960.40.350	
.20	231	960.40.300	960.40.350	
.212	244	960.40.300	960.40.375	
.23	256	960.40.325	960.40.375	
.237	269	960.40.325	960.40.400	
.25	281	960.40.350	960.40.400	
.262	294	960.40.350	960.40.425	
.28	306	960.40.375	960.40.425	
.29	319	960.40.375	960.40.450	
.30	331	960.40.400	960.40.450	
.312	344	960.40.400	960.40.475	
.325	356	960.40.425	960.40.475	
.337	369	960.40.425	960.40.500	
.350	381	960.40.450	960.40.500	
.362	394	960.40.450	960.40.525	
.375	406	960.40.475	960.40.525	
.387	419	960.40.475	960.40.550	
.400	431	960.40.500	960.40.550	

Insert for the installation set "Heavy-Duty": **973.50.XXX** instead of (960.40.XXX) on the right column "attached outwards"

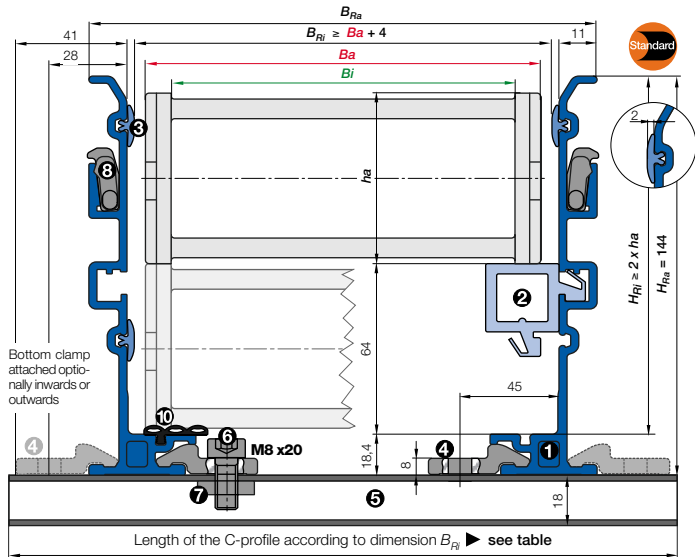

- Components, trough "Basic": ① Trough side parts, aluminum, 2 m ② Glide bar, plastic, 2 m ③ Glide strips, plastic, 2 m (without glide strips on request) ⑩ Optional: Silencer profile, rubber
- Components, installation set "Basic": ④ Bottom clamp, aluminum ⑤ C-profile, steel galvanized ⑥ Screw M8 x20 ⑦ Sliding nut M8 ⑧ Interface connector, plastic



### Order example: Length of travel 30 m - Center mounted for Series 3838.20.300.0 with $B_{Ri} = 231$

- Guide trough set (set of 2 trough side parts, incl. glide strips) **without** glide bar  
Order text: 16 m guide trough without glide bar (8 x 2 m sections) **Part No. 973.30.SL**
- Guide trough set (set of 2 trough side parts, incl. glide strips) **with** glide bar  
Order text: 16 m guide trough with glide bar (8 x 2 m sections) **Part No. 973.31.SL**
- Installation set "Basic" complete (guide trough-sets + 1)  
Order text: 17 installation sets "Basic" **Part No. 960.40.175**
- Module for the fixed end  
Order text: 1 set **Part No. 973.81**
- Option: For an additional noise dampening with silencer profile, please add Index A - Example: **Part No. 973.30.SLA**

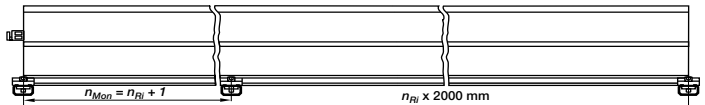

Principle sketch: Number of installation sets to be installed = Number of trough sections + 1

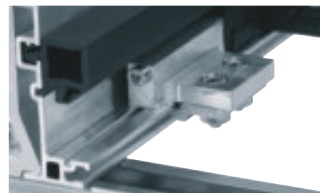

### NEW! A quick fix for mounting the stationary end of an E-Chain®

With this new module for the fixed end, fast and easy mounting onto the Aluminum "SuperTrough" is now possible without any drilling. Fast mounting of the E-Chain" by clamping onto the aluminum trough ● Quick relocation of the stationary end ● No drilling necessary ▶ page 9.16

Phone +49- (0) 22 03-96 49-800  
Fax +49- (0) 22 03-96 49-222

igus® GmbH  
51147 Cologne

Internet: www.igus.de  
E-mail: info@igus.de

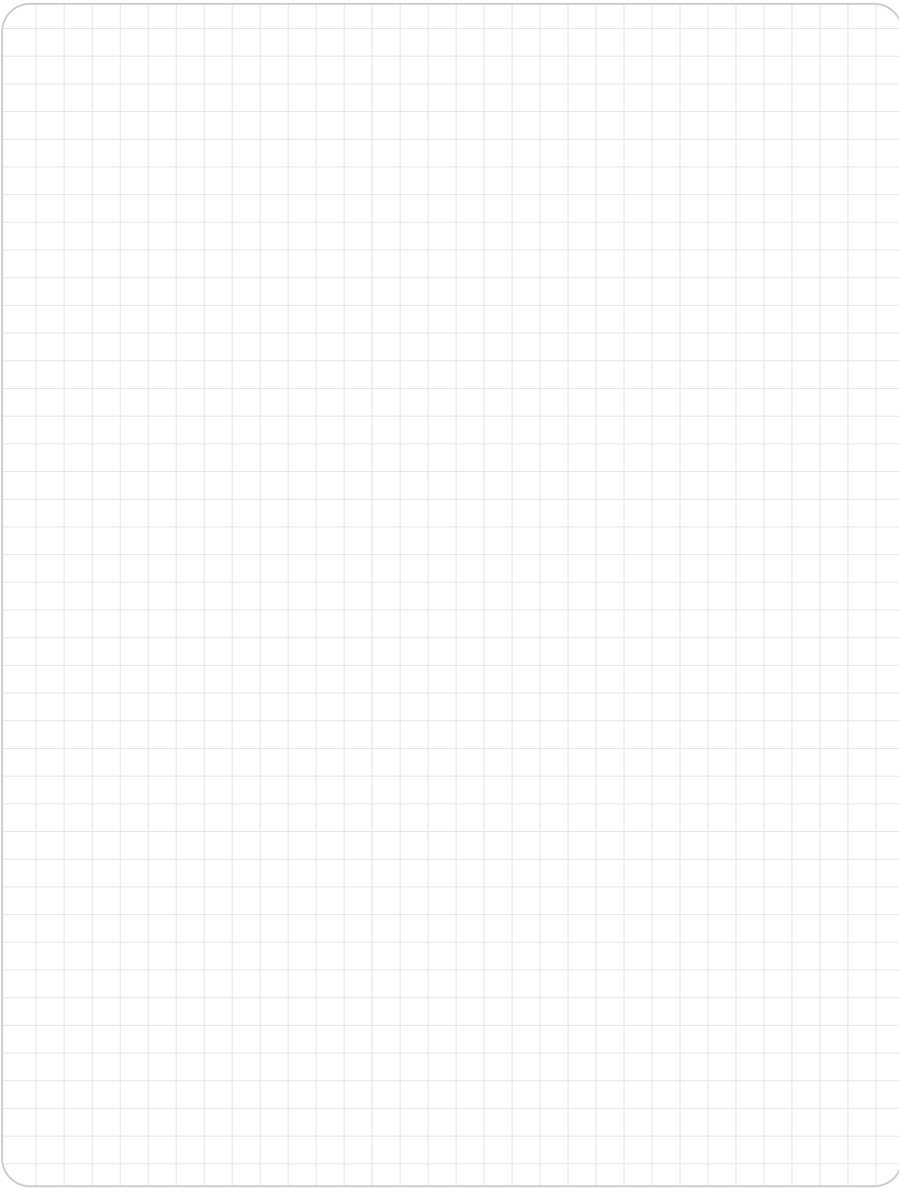

System E4/4  
Inner height: 42 mm

Phone +49- (0) 22 03-96 49-800  
Fax +49- (0) 22 03-96 49-222



▶ Chapter 9



▶ page 7.91

## TPE-Control cable for low-temperature applications - Chainflex® CF10

TIP!

TPE-outer jacket, oil- and bio-oil-resistant, PVC- and halogen-free, low-temperature-flexible  
Further information: [www.igus.de/en/CF10](http://www.igus.de/en/CF10)

IGUS® CHAINFLEX® CF10



Price index



Side-mounted -  
unsupported



ESD classification:  
Electrically conductive ESD/ATEX  
version upon request



High torsional  
rigidity



Opening E-Chains®: Remove crossbars and clips - Insert screwdriver into the slot, push down, release by lever action



Remove lids/bottoms (E-Tubes) - Insert screwdriver into the slot, release by lever action



When to use the Series 4040/4140/R8840:

- When high torsional forces are expected
- For side-mounted applications involving large unsupported lengths
- For long-term operation in very moist environments
- Also available as Rol E-Chain®



When not to use it:

- If a quieter version is required
  - ▶ Series 400/410/R880, page 7.48
- If a simple and low-cost solution is required
  - ▶ Series 14040/R18840, page 7.162
- When very long travels or high additional loads are involved
  - ▶ Series 4040HD, page 7.128

- 1 High side-mount stability due to tongue and groove
- 2 High torsional rigidity
- 3 Closed and open styles can be combined
- 4 Hinged snap-open removable lids of E-Tube
- 5 Numerous interior separation possibilities
- 6 Crossbars on E-Chains® are removable along both radii
- 7 Lateral glide surfaces for side-mounted operation
- 8 Wide, rounded plastic crossbars - cable friendly
- 9 KMA mounting brackets with attachment points on all sides
- 10 Mounting brackets with integrated strain relief available, locking or pivoting
- 11 E-Chains® also available with reverse bending radius "RBR"

! New "Heavy-Duty" size available. Greater unsupported length for higher loads and travels. Also available as Rol E-Chain® version



Rol E-Chain® Series  
4040R/8840R available  
upon request

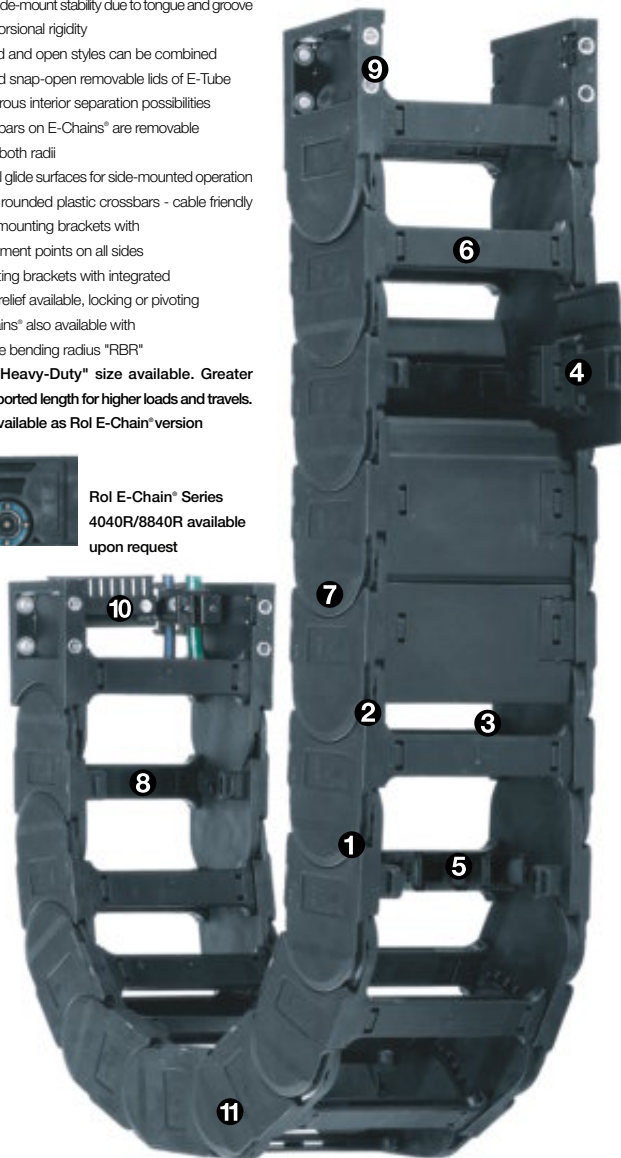

Order example complete E-Chain®

Please indicate chain-lengths or number of links Example: 5 m or 55 links

5 m 4040.30.300.0

E-Chain®

with 2 separators 411 assembled every 2<sup>nd</sup> link

Interior separation

1 set 40400.30.12C

Mounting bracket

**Unsupported length**

$FL_G$  = with straight upper run

$FL_B$  = with permitted sag

Further information ► **Design, page 1.12**

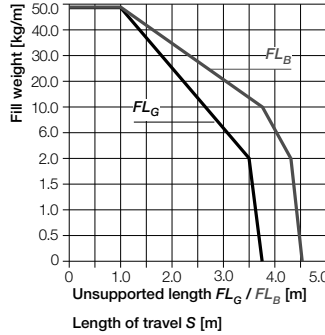
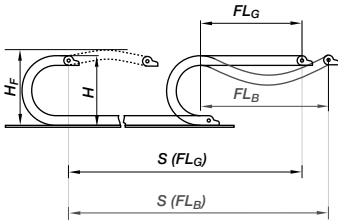

- $S$  = Length of travel
  - $R$  = Bending radius
  - $H$  = Nominal clearance height
  - $H_F$  = Required clearance height
  - $H_{in}$  = Trough inner height
  - $D$  = Overlength E-Chain" radius in final position
  - $K = \pi \cdot R + \text{"safety"}$
  - $D_2$  = Over length - long travels, gliding
  - $K_2$  = "Further add-on
  - $H_2$  = "Mounting height
- \*if the mounting bracket location is set lower

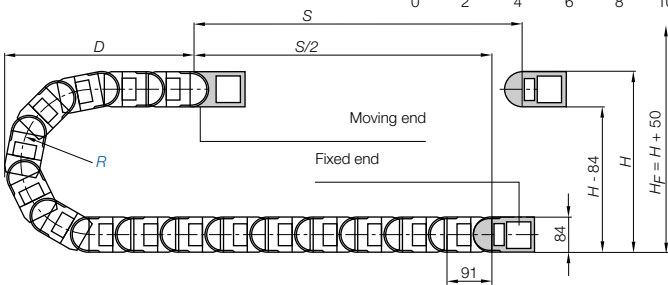

Pitch = 91 mm/link    Links/m = 11 (1001 mm)    Chain length =  $S/2 + K$

R	135	150	175	200	240	250	300	350	400	500
$H_{25}^0$	360	385	435	485	565	585	685	785	885	1085
D	270	285	310	335	375	385	435	485	535	635
K	650	750	825	900	1020	1050	1225	1340	1450	1775
$D_2^{+25}$	-	480	600	730	930	940	1200	1440	1530	1850
$K_2$	-	819	1092	1274	1547	1638	2002	2366	2548	3185
$H_2$	-	266	266	266	266	266	266	266	266	266

**Other installation methods**

- Vertical, hanging  $\leq 100$  m
- Vertical, standing  $\leq 6$  m
- Side mounted, unupp.  $\leq 3$  m
- Rotary requires further calculation
- Unsupported length of upper run = upon request

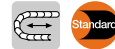

**Short travels - unsupported**

Unsupported E-Chains® feature positive camber over short travels. This must be accounted for when specifying the clearance height  $H_F$ . Please consult igus® if space is particularly restricted.

The required clearance height:  
 $H_F = H + 50$  mm  
(with 3,0 kg/m fill weight)

**Long travel lengths from 10 m to max. 300 m    Chain length =  $S/2 + K_2$**

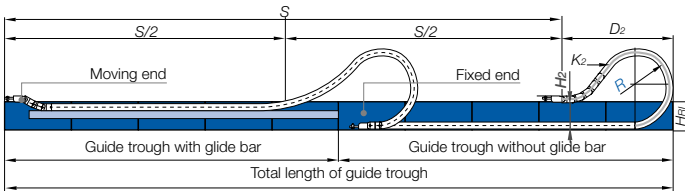

In case of travels between 4 and 10 m we recommend a longer unsupported length.



**Gliding, long travel applications (max. 300 m)**

In this case the E-Chain® upper run will be introduced in a guide trough on the lower run. We recommend to realize the engineering of such a plant by our technicians.

Speed / acceleration $FL_G$	max. 20 [m/s] / max. 200 [m/s <sup>2</sup> ]
Speed / acceleration $FL_B$	max. 3 [m/s] / max. 6 [m/s <sup>2</sup> ]
Gliding speed / acceleration (maximum)	max. 10 [m/s] / max. 50 [m/s <sup>2</sup> ]
Material - permitted temperature °C	igumid G / -40° up to +120° C
Flammability class, igumid G	VDE 0304 IIC UL94 HB

**Technical Data**



Details of material properties  
► page 1.38



► page 7.91



## Series 4040- E-Chain®

Crossbars every link  
For rigid hydraulic hoses  
For applications particularly demanding  
Can be opened from two sides

Part No. structure

4040. 30. 250. 0



Color

black

Bending

radius

Width

Series

## Series 41406- E-Chain® with crossbars every 2<sup>nd</sup> link

Crossbars every 2<sup>nd</sup> link = Standard  
For nearly every situation  
Can be opened from two sides  
Easy assembly  
Stable  
Attractive price

Part No. structure

Color

black

Bending

radius

Width

Series

Phone +49- (0) 22 03-96 49-800  
Fax +49- (0) 22 03-96 49-222

igus® GmbH  
51147 Cologne

## Series R88406- Fully enclosed E-Tube

Fully enclosed  
Excellent cable protection against dirt  
Protection against hot chips (up to 900°C)  
Lids along the entire inner radius are completely removable. Lids along the entire outer radius are single sided snap-open with a hinge on the other side to keep them attached to the chain or completely removable.

Part No. structure

Color

black

Bending

radius

Width

Series

Internet: [www.igus.de](http://www.igus.de)  
E-mail: [info@igus.de](mailto:info@igus.de)

## Rol instead of gliding: Rol E-Chain®

Special solution for long travels. 75% less drive power  
(gliding application) with igus® Rol E-Chain®.  
Series 4040R - Order example 4040R.30.250.0

Further information: [www.igus.de/en/role](http://www.igus.de/en/role)  
or phone: +49-0 22 03-96 49-800



Part No.	Bi		Ba	4040	4140	R8840
	[mm]	[mm]	[mm]	[kg/m]	[kg/m]	[kg/m]
4040/4140/05.	.0	50	86	≈ 3,65	≈ 3,58	-
4040/4140/06.	.0	65	101	≈ 3,67	≈ 3,60	-
4040/4140/8840.07.	.0*	75	111	≈ 3,78	≈ 3,70	≈ 4,24
4040/4140/8840.10.	.0	100	136	≈ 3,96	≈ 3,78	≈ 4,52
4040/4140/11.	.0	112	149	≈ 4,09	≈ 3,85	-
4040/4140/8840.12.	.0	125	161	≈ 4,16	≈ 3,88	≈ 4,88
4040/4140.13.	.0	137	174	≈ 4,29	≈ 3,95	-
4040/4140/8840.15.	.0	150	186	≈ 4,36	≈ 3,98	≈ 5,31
4040/4140.16.	.0	162	199	≈ 4,47	≈ 4,04	-
4040/4140.17.	.0	175	211	≈ 4,58	≈ 4,09	-
4040/4140.18.	.0	187	224	≈ 4,69	≈ 4,15	-
4040/4140/8840.20.	.0	200	236	≈ 4,71	≈ 4,16	≈ 5,89
4040/4140.21.	.0	212	249	≈ 4,82	≈ 4,21	-
4040/4140.22.	.0	225	261	≈ 4,88	≈ 4,25	-
4040/4140.23.	.0	237	274	≈ 5,02	≈ 4,31	-
4040/4140/8840.25.	.0	250	286	≈ 5,10	≈ 4,36	≈ 6,61
4040/4140.26.	.0	262	299	≈ 5,19	≈ 4,40	-
4040/4140/8840.27.	.0	275	311	≈ 5,30	≈ 4,46	≈ 6,89
4040/4140.28.	.0	287	324	≈ 5,32	≈ 4,47	-
4040/4140/8840.30.	.0	300	336	≈ 5,54	≈ 4,58	≈ 7,27
4040/4140.31.	.0	312	349	≈ 5,58	≈ 4,60	-
4040/4140.32.	.0	325	361	≈ 5,63	≈ 4,62	-
4040/4140.33.	.0	337	374	≈ 5,81	≈ 4,71	-
4040/4140/8840.35.	.0	350	386	≈ 5,96	≈ 4,79	≈ 8,02
4040/4140.36.	.0	362	399	≈ 5,96	≈ 4,79	-
4040/4140.37.	.0	375	411	≈ 5,98	≈ 4,80	-
4040/4140.38.	.0	387	424	≈ 6,07	≈ 4,84	-
4040/4140/8840.40.	.0	400	436	≈ 6,27	≈ 4,94	≈ 8,98
4040/4140.41.	.0	412	449	≈ 6,42	≈ 5,02	-
4040/4140.42.	.0	425	461	≈ 6,58	≈ 5,09	-
4040/4140.43.	.0	437	474	≈ 6,64	≈ 5,13	-
4040/4140.45.	.0	450	486	≈ 6,71	≈ 5,16	-
4040/4140/8840.46.	.0	462	499	≈ 6,73	≈ 5,19	≈ 9,44
4040/4140.47.	.0	475	511	≈ 6,86	≈ 5,24	-
4040/4140.48.	.0	487	524	≈ 6,88	≈ 5,28	-
4040/4140.50.	.0	500	536	≈ 7,00	≈ 5,30	-
4040/4140.51.	.0	512	549	≈ 7,02	≈ 5,31	-
4040/4140.52.	.0	525	561	≈ 7,06	≈ 5,34	-
4040/4140.53.	.0	537	574	≈ 7,22	≈ 5,41	-
4040/4140.55.	.0	550	586	≈ 7,70	≈ 5,65	-
4040/4140.60.	.0	600	636	≈ 7,90	≈ 5,75	-

Available bending radii

R [mm] 135\*\* 150 175 200 240 250 300 350 400 500

Supplement Part No. with required radius. Example: 4040.30.300,0

0 = standard color, other colors ▶ page 1.39 · Pitch = 91 mm/link · Links/m = 11

\*Removable lid only, no hinged option · \*\*not available for R8840

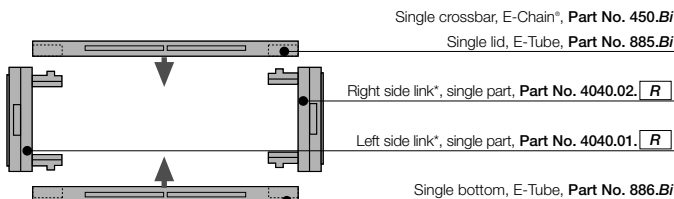

**TIP!**  
**Hot Chips up to 850°C**  
 E-Tubes that repel hot chips, up to 850 °C  
 Some applications, depending on amount and size of the chips, can burn or melt the surface. That is no longer the case with the new igus® "Igmuid HT" material.  
 Further information: [www.igus.de/en/HT](http://www.igus.de/en/HT) or phone: +49-0 22 03-96 49-800

**TIP!**  
**Extreme Glider...**  
 with up to 70% larger glide surface. For high additional loads and high gliding speeds. Gliding applications without additional elements as well as 150% more wear allowance and improvement of service life by factor 4!  
 Order example: 4040.35G.250.0 4040.45G.250.0

Further information: phone +49-0 22 03-96 49-800

**i**  
 Extender crossbar for large diameter hoses ▶ page 7.122

**Part No. E-Chain® - links, single parts**  
 \*View from the fixed point of the E-Chain®/E-Tube

System E4/4  
 Inner height: 56 mm

Phone +49- (0) 22 03-96 49-800  
 Fax +49- (0) 22 03-96 49-222



**Option 1**

- Vertical separators
- Spacers
- Locking separators
- Asymmetric separators

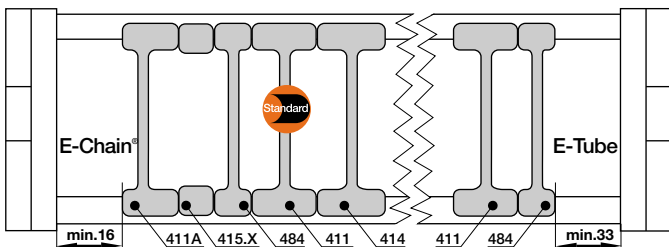

Vertical separator  
401



Vertical separator  
483



Spacer  
405.10



Spacer  
405.15



Spacer  
405.20



Spacer  
405.30



Spacer  
405.40



Locking separator  
404



Asymmetric  
separator 401A

**Vertical separator  
for E-Chains®/E-Tubes**

unassembled	401
assembled	411



**Vertical separator  
for E-Chains®/E-Tubes**

unassembled	483
assembled	484



**Spacer\***

for E-Chains®

unassembled	405.10
assembled	415.10



**Spacer\***

for E-Chains®

unassembled	405.15
assembled	415.15



**Spacer\***

for E-Chains®

unassembled	405.20
assembled	415.20



**Spacer\***

for E-Chains®

unassembled	405.30
assembled	415.30



**Spacer\***

for E-Chains®

unassembled	405.40
assembled	415.40



**Locking separator**

for E-Chains®

unassembled	404
assembled	414



**Asymmetric separator  
for E-Chains®**

unassembled	401A
assembled	411A



\*For side-mounted applications

**Option 1: Vertical separators and spacers**

Vertical separators are used if a vertical subdivision of the E-Chain® interior is required - By standard vertical separators are assembled every other E-Chain® link. **Note:** Observe a lateral spacing of at least 16 mm for E-Chains® and at least 33 mm for E-Tubes!

● **Standard separator 401 for E-Chains® and E-Tubes** offers safe stability due to its wide base design, also when used with thick cables or hoses.

● **Vertical separator 483 with a narrow base for E-Chains® and E-Tubes** with applications where a large number of small cables need to be individually separated.

● **Vertical separators in side-mounted applications**, for instance, can be fixed in position by means of **spacer 405.X for E-Chains®**. A wide range of intervals between the vertical separators is adjustable here.

● **Note on spacers:** The available interior height is reduced by 2 mm per spacer (4 mm when spacers are fitted on both sides). To avoid this, the parts can also be installed from the outside on the opening crossbar.

**Additionally:**

● **Locking separator for E-Chains® 404** - with increased retention force for applications exposed to very high humidity or extreme loads. The extra retention force is achieved by asymmetric claws for the crossbar. Ensure proper alignment.

● **Locking separator 406 for E4-Tubes** - safe fitting locked on lid or bottom of the Tube and sideways slideable. The opposing lid or bottom can easily be opened and closed. Especially capable if many separators need to be assembled on a tight inner width. **Art. Nr. not assembled 406 - Art. Nr. assembled 416.** For illustration, refer to **vertical separator 404**.

● **Asymmetric separator 401A for E-Chains®** (not for E-Tubes) with an 18-mm base, for combinations between spacers of different widths and vertical separators in side-mounted applications, for instance.

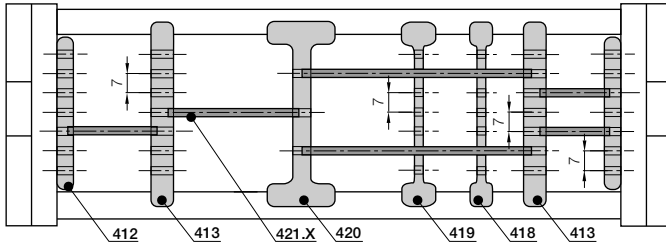

**Option 2**

- Side plates
- Middle plates
- Locking vertical separator
- Slotted separators
- Open slotted separators

**Option 2: Shelves**

For applications involving many cables with different diameters. The shelves can be arranged elevator-shifted with different bottoms.

- Side plates 402, middle plates 403 and shelves 420.X form the basic pattern of a shelf system. Shelves of various widths can be arranged at 7 different heights (in 7 mm increments).
- Locking vertical separator 410, slotted combined with shelves.
- Slotted separators 408 are used for very fine subdivisions. However, they cannot be retrofitted into an existing separation system without dismantling the interior separators first.
- The unilateral open slotted separator 409 can be retrofitted into an existing interior separation system without a need for dismantling the interior separators. During an installation of open slotted separators, the top and bottom notches cannot be occupied by shelves.



<b>Side plate for E-Chains®/E-Tubes</b>		
unassembled	402	
assembled		412



<b>Middle plate for E-Chains®/E-Tubes</b>		
unassembled	403	
assembled		413

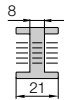

<b>Locking vertical separator for E-Chains®/E-Tubes</b>		
unassembled	410	
assembled		420



<b>Slotted separator for E-Chains®/E-Tubes</b>		
unassembled	408	
assembled		418

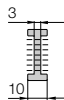

<b>Open slotted separator for E-Chains®/E-Tubes</b>		
unassembled	409	
assembled		419

Width X [mm]	Part No. unassembled	Part No. assembled
18	420.18	421.18
23	420.23	421.23
25	420.25	421.25
28	420.28	421.28
33	420.33	421.33
43	420.43	421.43
50	420.50	421.50
62	420.62	421.62

Width X [mm]	Part No. unassembled	Part No. assembled
75	420.75	421.75
88	420.88	421.88
100	420.100	421.100
125	420.125	421.125
150	420.150	421.150
175	420.175	421.175
187	420.187	421.187
200	420.200	421.200



Side plate 402



Middle plate 403



Locking vertical separator 410



Slotted separator 408



Open slotted separator 409



Shelf 420.X

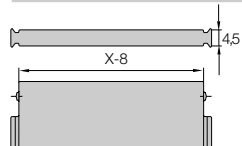

**Additional elements for interior separation**

	<b>Center crossbar</b>	
	unassembled	405
	assembled	415

**Center crossbar** - was developed for applications with a large number of thin cables. The center crossbar offers the option of subdividing the E-Chain® independently into upper and lower halves.

	<b>Rollclip</b>	
	unassembled	489.27
	assembled	490.27

**Rollclip** - minimizes abrasion of particularly sensitive hoses. The Rollclip is simply clamped onto the opening crossbar. The movable rollers compensate for relative movement between the chain and hose.

	<b>Roller separator</b>	
	unassembled	429
	assembled	430

**Roller separator** - performs a similar function to the Rollclip, but doubles as a separator.





Part No. structure  
4040.10 /20 /10. 200.0  
4040.Bi1/Bi2/Bi3. R 1.0

### Extension links - for extremely wide E-Chains® up to 3,0 m

- For applications in which particularly high fill weights necessitate extremely wide E-Chains® (up to 3000 mm)
- The extension link design allows virtually limitless side-by-side attachment of chains
- The unsupported length of a chain can be increased when additional loads are required
- Extension links can be used with E-Chains®, E-Tubes or as a combination of both
- They are suitable for unsupported and gliding applications in a guide trough
- E-Chains® with extension links are attached with KMA or steel mounting brackets

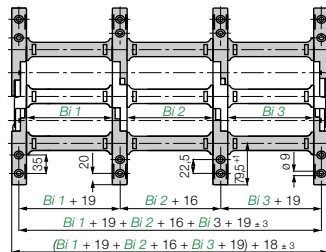

Consult igus® for your extender crossbar applications. We are happy to assist you with your design layout

### Extender crossbars - careful guide of hoses applications

- Suitable for hoses with a maximum outer diameter of 300 mm
- Gliding operation with crossbars assembled along the outer radius and a special guide trough
- Gliding operation not guaranteed with crossbars assembled along the inner radius
- The extender crossbar can either be attached to the side links directly or can be used in combination with two stranded snap-open crossbars

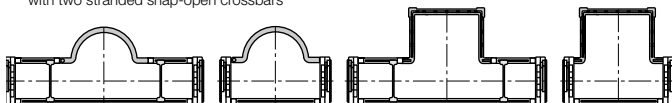

Round extender crossbar with snap-open crossbars    Attached directly to the side link    Square extender crossbar with snap-open crossbars    Attached directly to the side link

Part No.	Max Ø [mm] hose	Form	Installation side link	Combination with snap-open crossb.
450.15.RHD115	115	○	-	+
450.17.RD115	115	○	+	-
450.25.D150	150	□	+	-
450.30.D200	180	□	+	-
450.35.D250	195	□	+	-
450.40.D300	245	□	+	-
450.20.HD150	150	□	-	+
450.25.HD200	180	□	-	+
450.30.HD250	195	□	-	+

○ = round    □ = square    + = yes / - = no



### E4 clip-on cable binder

- For side-mounted applications    ● Serves as a clip-on, lateral guide for hoses and cables on E-Chains®
- The loops can be adjusted as required    ● Compatible with many E4 E-Chains®    ● Stylish and economical
- One clip and one locking band are needed for each chain link    ● Call us if you have any questions on project planning

Part No.	Form
450.B12	Locking clip, comprising a locking element
450.B12.200	Locking band, comprising a locking element and band; 12 x 1,5 x 200 mm

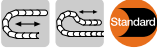

### The Standard - Option KMA\* - pivoting

- Recommended for unsupported and gliding applications
- Confined installation conditions
- Option - integrated C-profile strain relief device with Chainfix clip or strain relief tiwrap plates
- Corrosion resistant
- Universal mountable with attachment capability on all sides

\*KMA = Polymer Metal Mounting Bracket

Moving end  
40400/88400...1

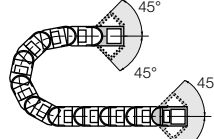

Fixed end  
40400/88400...2



The attachment variants arising automatically by the choice of the KMA mounting bracket

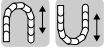
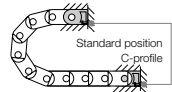

### Option KMA - locking

- Recommended for vertical hanging / standing applications

#### Additionally:

- Universal mountable
- C-profile option
- Corrosion resistant
- Locked connections
- At very high acceleration

Moving end  
41400/89400...1

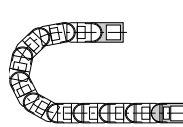

Fixed end  
41400/89400...2



The attachment variants arising automatically by the choice of the KMA mounting bracket

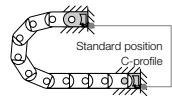

Fixed end 40400/88400...2 (pivoting)  
41400/89400...2 (locking)

Moving end 40400/88400...1 (pivoting)  
41400/89400...1 (locking)

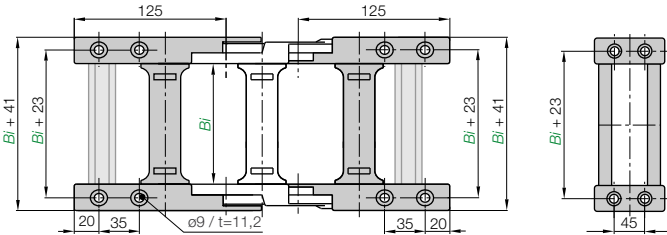

index	Part No. full set		C-profile	$Bi$	index	Part No. full set		C-profile	$Bi$
	pivoting	locking	option [mm]	option [mm]		pivoting	locking	option [mm]	option [mm]
.05.	40400	41400	.05.12	50	.32.	40400	41400	.32.12	325
.06.	40400	41400	.06.12	65	.33.	40400	41400	.33.12	337
.07.	40400/88400	41400/89400	.07.12	75	.35.	40400/88400	41400/89400	.35.12	350
.10.	40400/88400	41400/89400	.10.12	100	.36.	40400	41400	.36.12	362
.11.	40400	41400	.11.12	112	.37.	40400	41400	.37.12	375
.12.	40400/88400	41400/89400	.12.12	125	.38.	40400	41400	.38.12	387
.13.	40400	41400	.13.12	137	.40.	40400/88400	41400/89400	.40.12	400
.15.	40400/88400	41400/89400	.15.12	150	.41.	40400	41400	.41.12	412
.16.	40400	41400	.16.12	162	.42.	40400	41400	.42.12	425
.17.	40400	41400	.17.12	175	.43.	40400	41400	.43.12	437
.18.	40400	41400	.18.12	187	.45.	40400	41400	.45.12	450
.20.	40400/88400	41400/89400	.20.12	200	.46.	40400/88400	41400/89400	.46.12	462
.21.	40400	41400	.21.12	212	.47.	40400	41400	.47.12	475
.22.	40400	41400	.22.12	225	.48.	40400	41400	.48.12	487
.23.	40400	41400	.23.12	237	.50.	40400	41400	.50.12	500
.25.	40400/88400	41400/89400	.25.12	250	.51.	40400	41400	.51.12	512
.26.	40400	41400	.26.12	262	.52.	40400	41400	.52.12	525
.27.	40400/88400	41400/89400	.27.12	275	.53.	40400	41400	.53.12	537
.28.	440400	41400	.28.12	287	.55.	40400	41400	.55.12	550
.30.	40400/88400	41400/89400	.30.12	300	.60.	40400	41400	.60.12	600
.31.	40400	41400	.31.12	312					

### Dimensions and order configurations

#### Part No. structure (pivoting)

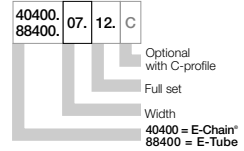

#### Part No. structure (locking)

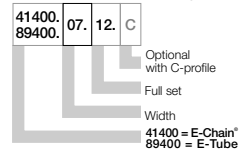

#### Full set, for both ends:

40400.05.12

#### Single-part order:

40400.05.1

Mounting bracket with bore

40400.05.1.2

Mounting bracket with pin

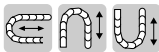

**Option steel - pivoting**

- For pivoting connections
- One part (two-piece) for all chain widths
- Electrically conductive

Moving end  
40400.1

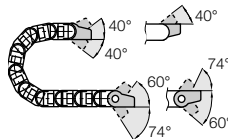

Fixed end  
40400.2

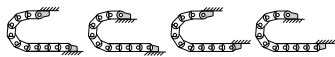

Possible installation conditions -

Further installation angles ► installation sketch

Phone +49- (0) 22 03-96 49-800  
Fax +49- (0) 22 03-96 49-222

igus® GmbH  
51147 Cologne

Internet: [www.igus.de](http://www.igus.de)  
E-mail: [info@igus.de](mailto:info@igus.de)

Moving end  
40400.1

Fixed end  
40400.2

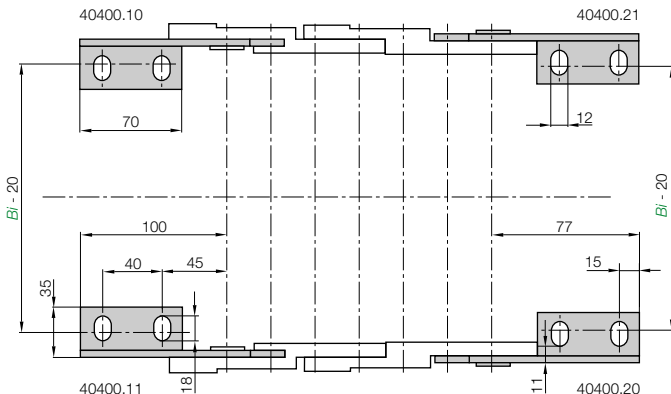

For E-Chain®	Part No.	full set	Bi [mm]	For E-Chain®	Part No.	full set	Bi [mm]
4040-4140.05	► 40400.	12	50	4040-4140.32	► 40400.	12	325
4040-4140.06	► 40400.	12	65	4040-4140.33	► 40400.	12	337
4040-4140-8840.07	► 40400.	12	75	4040-4140-8840.35	► 40400.	12	350
4040-4140-8840.10	► 40400.	12	100	4040-4140.36	► 40400.	12	362
4040-4140.11	► 40400.	12	112	4040-4140.37	► 40400.	12	375
4040-4140-8840.12	► 40400.	12	125	4040-4140.38	► 40400.	12	387
4040-4140.13	► 40400.	12	137	4040-4140-8840.40	► 40400.	12	400
4040-4140-8840.15	► 40400.	12	150	4040-4140.41	► 40400.	12	412
4040-4140.16	► 40400.	12	162	4040-4140.42	► 40400.	12	425
4040-4140.17	► 40400.	12	175	4040-4140.43	► 40400.	12	437
4040-4140.18	► 40400.	12	187	4040-4140.45	► 40400.	12	450
4040-4140-8840.20	► 40400.	12	200	4040-4140-8840.46	► 40400.	12	462
4040-4140.21	► 40400.	12	212	4040-4140.47	► 40400.	12	475
4040-4140.22	► 40400.	12	225	4040-4140.48	► 40400.	12	487
4040-4140.23	► 40400.	12	237	4040-4140.50	► 40400.	12	500
4040-4140-8840.25	► 40400.	12	250	4040-4140.51	► 40400.	12	512
4040-4140.26	► 40400.	12	262	4040-4140.52	► 40400.	12	525
4040-4140-8840.27	► 40400.	12	275	4040-4140.53	► 40400.	12	537
4040-4140.28	► 40400.	12	287	4040-4140.55	► 40400.	12	550
4040-4140-8840.30	► 40400.	12	300	4040-4140.60	► 40400.	12	600
4040-4140.31	► 40400.	12	312				

40400.12 Full set, 4 parts

2 with pin / 2 with bore

Single-part order:

40400.1 Mounting bracket

with bore, 1 part left / right

40400.2 Mounting bracket

with pin, 1 part left / right

### Chainfix clamps for the C-profile

Part No. single clamps		Part No. double clamps		Part No. triple clamps		Cable
steel	stainless steel	steel	stainless steel	steel	stainless steel	ø [mm]
CFX12.1	CFX12.1.E	CFX12.2	CFX12.2.E	CFX12.3	-	06 - 12
CFX14.1	CFX14.1.E	CFX14.2	CFX14.2.E	CFX14.3	-	12 - 14
CFX16.1	CFX16.1.E	CFX16.2	CFX16.2.E	CFX16.3	-	14 - 16
CFX18.1	CFX18.1.E	CFX18.2	CFX18.2.E	CFX18.3	-	16 - 18
CFX20.1	CFX20.1.E	CFX20.2	CFX20.2.E	CFX20.3	-	18 - 20
CFX22.1	CFX22.1.E	CFX22.2	CFX22.2.E	CFX22.3	-	20 - 22
CFX26.1	CFX26.1.E	CFX26.2	CFX26.2.E	-	-	22 - 26
CFX30.1	CFX30.1.E	CFX30.2	CFX30.2.E	-	-	26 - 30
CFX34.1	CFX34.1.E	CFX34.2	CFX34.2.E	-	-	30 - 34
CFX38.1	CFX38.1.E	-	-	-	-	34 - 38
CFX42.1	CFX42.1.E	-	-	-	-	38 - 42



igus® Chainfix steel clamps and Chainfix stainless-steel clamps - max. pull forces, adjustable with hexagon socket. Available as single, double or triple clamps.

Details ► chapter 10

System E4/4  
Inner height: 56 mm

Cable ø [mm]	Part No. clamp	Part No. bottom part
04 - 08	CFC-08-M	CFC-08-C
08 - 12	CFC-12-M	CFC-12-C
12 - 16	CFC-16-M	CFC-16-C
16 - 20	CFC-20-M	CFC-20-C
20 - 24	CFC-24-M	CFC-24-C

### Chainfix Clip - Modular snap-on strain relief device for C-profile

Available for all igus® E-ChainSystems® with C-profiles and also suitable for assembly in the KMA mounting brackets and clip-on strain relief for crossbars. High pull forces, plug-in modular snap-on strain relief device. Details ► chapter 10



Part No.	ø max. conduit [mm]	Width [mm]
CFN.20	20	10,8

### Chainfix Nugget for the C-Profile

Strain relief for the fixation of cables up to a diameter of Ø 20 mm. Easy to assemble, without any screws and tools. Easy strain relief due to fixation with pre-harnessed cable strap, very small space requirement. Details ► chapter 10



Part No.	Width of strain relief [mm]	Number of teeth
3050.ZC	50	5
3075.ZC	75	7

### Chainfix tiwrap plates with clip-on connection for the C-profile

Can be plugged into the KMA C-profile. Easy to assemble without any screws. Easily solvable with screwdriver nevertheless safe stop. For all E-Chains® with KMA and integrated C-profile. Details ► chapter 10

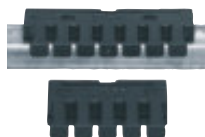

Tiewrap plate	No. of teeth n	Dim. C [mm]	Dim. B [mm]	Center bore
3050.ZB	5	50	30	-
3075.ZB	7	75	55	-
3100.ZB	10	100	80	-
3115.ZB	11	115	95	-
3125.ZB	12	125	105	-
3150.ZB	15	150	130	-
3175.ZB	17	175	155	-
3200.ZB	20	200	180	+
3225.ZB	22	225	205	+
3250.ZB	25	250	230	+

(- = no / + = yes)

### Tiewrap plate as individual part

As individual component screwed on KMA. Can be plugged in the mounting brackets. Details ► chapter 10

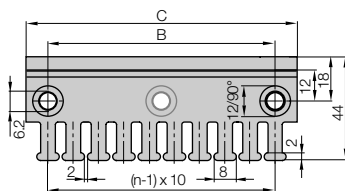

Single tiewrap plate

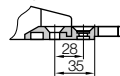

Shown assembled

Details about all strain relief option for this series ► chapter 10

Phone +49- (0) 22 03-96 49-800  
Fax +49- (0) 22 03-96 49-222



► Chapter 10



► page 7.91



- $B_a$  = Outer width E-Chains® / E-Tube
- $B_i$  = Inner width E-Chains® / E-Tube
- $h_a$  = Outer height E-Chains® / E-Tube
- $H_{Ri}$  = Inner trough height
- $H_{Ra}$  = Outer trough height
- $B_{Ri}$  = Inner trough width ► depends on dim.  $B_a$
- $B_{Ra}$  = Outer trough width
- $n_{Mon}$  = Number of installation sets (left/right)
- $n_{Ri}$  = Number of troughs sets (left/right)
- $H_{Ri} \geq 2 \cdot h_a$
- $B_{Ri} \geq B_a + 4$
- = Guide trough set    ● = Glide bar
- = Installation set "Basic"    ● = C-profile

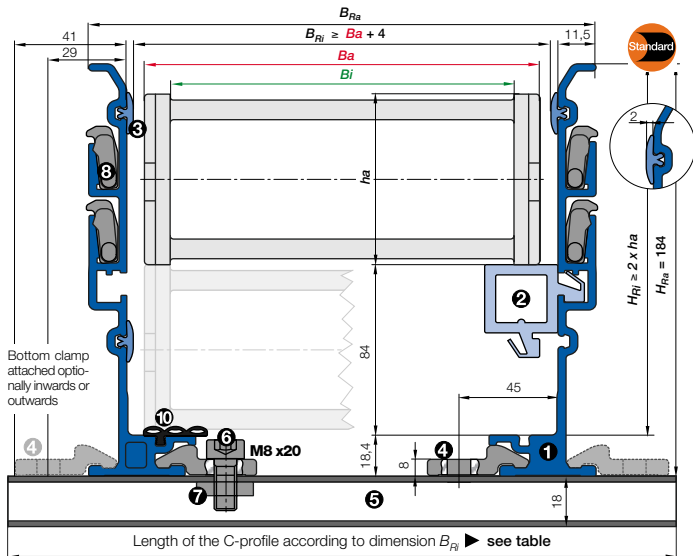

### Installation set "Basic" with C-profile

Bottom Clamp attached optionally inwards or outwards

4040.05.200.0 ► Order example

Part No.	Part No.	
	$B_{Ri}$ attached inwards [mm]	attached outwards
.05	90	960.50.200
.06	105	960.50.225
.07	115	960.50.225
.10	140	960.50.200
.11	153	960.50.200
.12	165	960.50.225
.13	178	960.50.225
.15	190	960.50.250
.16	203	960.50.250
.17	215	960.50.275
.18	228	960.50.275
.20	240	960.50.300
.21	253	960.50.300
.22	265	960.50.325
.23	278	960.50.325
.25	290	960.50.350
.26	303	960.50.350
.27	315	960.50.375
.28	328	960.50.375
.30	340	960.50.400
.31	353	960.50.400
.32	365	960.50.425
.33	378	960.50.425
.35	390	960.50.450
.36	403	960.50.450
.37	415	960.50.475
.38	428	960.50.475
.40	440	960.50.500
.41	453	960.50.500
.42	465	960.50.525
.43	478	960.50.525
.45	490	960.50.550
.46	503	960.50.550
.47	515	960.50.575
.48	528	960.50.575
.50	540	960.50.600
.51	553	960.50.600
.52	565	960.50.625
.53	578	960.50.625
.55	590	960.50.650
.60	640	960.50.700



- Components, trough "Basic": ① Trough side parts, aluminum, 2 m ② Glide bar, plastic, 2 m ③ Glide strips, plastic, 2 m (without glide strips on request) ⑩ Optional: Silencer profile, rubber
- Components, installation set "Basic": ④ Bottom clamp, aluminum ⑤ C-profile, steel galvanized ⑥ Screw M8 x20 ⑦ Sliding nut M8 ⑧ Interface connector, plastic



Order example: Length of travel 30 m - Center mounted for Series 4040.10.200.0 with  $B_{Ri} = 140$

Guide trough set (set of 2 trough side parts, incl. glide strips) <b>without</b> glide bar	Part No.	974.30.SL
Order text: 16 m guide trough without glide bar (8 x 2 m sections)		
Guide trough set (set of 2 trough side parts, incl. glide strips) <b>with</b> glide bar	Part No.	974.31.SL
Order text: 16 m guide trough with glide bar (8 x 2 m sections)		
Installation set "Basic" complete (guide trough-sets + 1)	Part No.	960.50.200
Order text: 17 installation sets "Basic"		
Module for the fixed end	Part No.	974.80
Order text: 1 set		
Option: For an additional noise dampening with silencer profile, please add Index A - Example:	Part No.	974.30.SLA

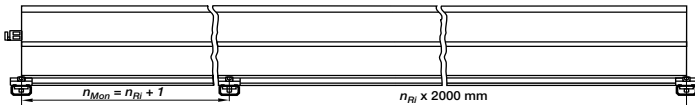

Principle sketch: Number of installation sets to be installed = Number of trough sections + 1

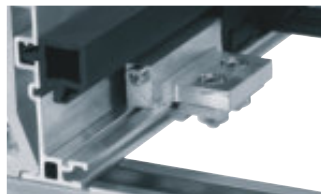

### NEW! A quick fix for mounting the stationary end of an E-Chain®

With this new module for the fixed end, fast and easy mounting onto the Aluminum "SuperTrough" is now possible without any drilling. Fast mounting of the E-Chain® by clamping onto the aluminum trough

- Quick relocation of the stationary end
- No drilling necessary ► page 9.16

Phone +49- (0) 22 03-96 49-800  
Fax +49- (0) 22 03-96 49-222

igus® GmbH  
51147 Cologne

Internet: www.igus.de  
E-mail: info@igus.de

Insert for the installation set "Heavy-Duty": **974.50.XXX** instead of (960.50.XXX) on the right column "attached outwards"

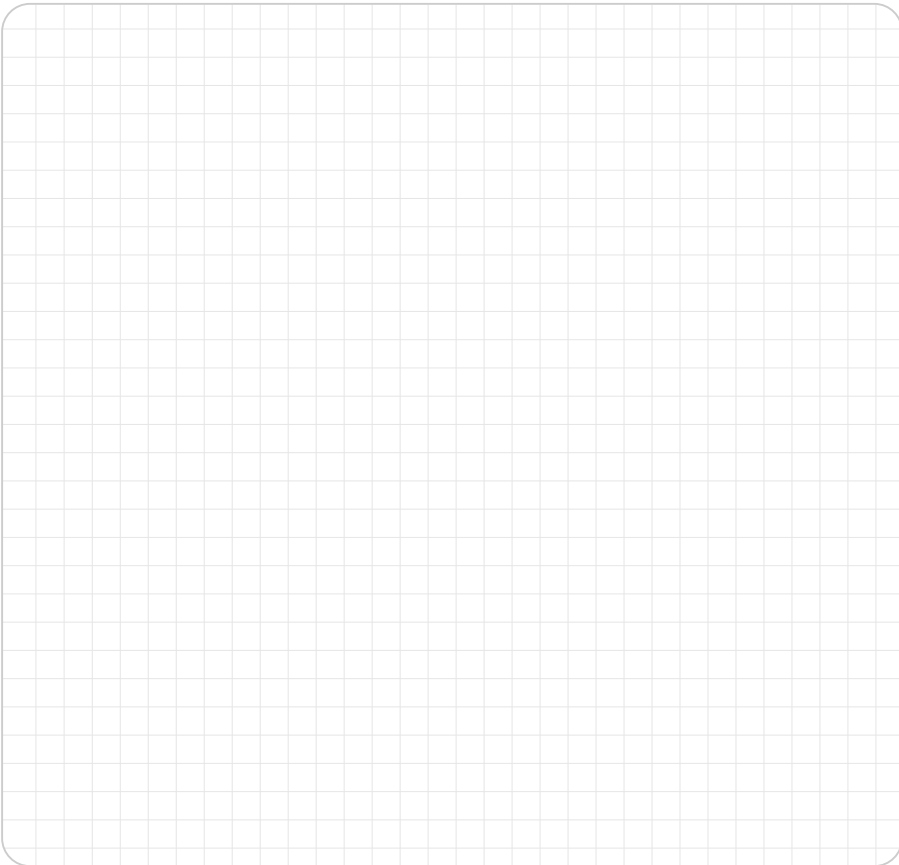

System E4/4  
Inner height: 56 mm

Phone +49- (0) 22 03-96 49-800  
Fax +49- (0) 22 03-96 49-222



▶ Chapter 9



▶ page 7.91



TIP!

# Series 4040AX

## Special E-Chains® for fine dust applications

For long travel applications and fine dust applications, we have developed a special E-ChainSystem® with exterior, dirt-repellent stop dogs.

- Exterior stop dogs prevent the settling of dust, dirt, chips, flour, etc.
- Mounting brackets and accessories from the serie 4040

Series 4040AX - Order example: 4040AX.30.250.0

Further information: [igus.de/en/4040AX](http://igus.de/en/4040AX) or phone +49-0 22 03-96 49-800

Price index



Series 4040HD Series R8840HD



"Heavy-Duty" version  
for long travel applications



ESD classification:  
Electrically conductive ESD/ATEX  
version upon request



Very high torsional rigidity  
and and tensile force



Opening E-Chains\*: Remove crossbars and clips - Insert screwdriver into the slot, push down, release by lever action



Remove lids/bottoms (E-Tubes) - Insert screwdriver into the slot, release by lever action



When to use the Series 4040HD/R8840HD:

- For high (tensile-)charges at long travel applications
- When high torsional forces are expected
- For long-term operation in very moist environments
- Also available as Rol E-Chain\*



When not to use them:

- If a quieter version is required  
▶ Series 400/410/R880, page 7.46
- If a simple and low-cost solution is required  
▶ Series 14040/R18840, page 7.162
- At short travels or medium additional loads  
▶ Series 4040/4140/R8840, page 7.116

- ① High side-mount stability due to tongue and groove
- ② High torsional rigidity
- ③ High tensile stability (20% higher tensile force than Series 4040)
- ④ Very wide gliding surface, less wear
- ⑤ Closed and open styles can be combined
- ⑥ Hinged snap-open removable lids along outer radius of E-Tube
- ⑦ Numerous interior separation possibilities
- ⑧ Crossbars are removable along both radii
- ⑨ Wide, rounded plastic crossbars - cable friendly
- ⑩ Robust Steel-Mounting Brackets



Rol E-Chain\* Series  
4040RHD and R8840RHD  
available upon request

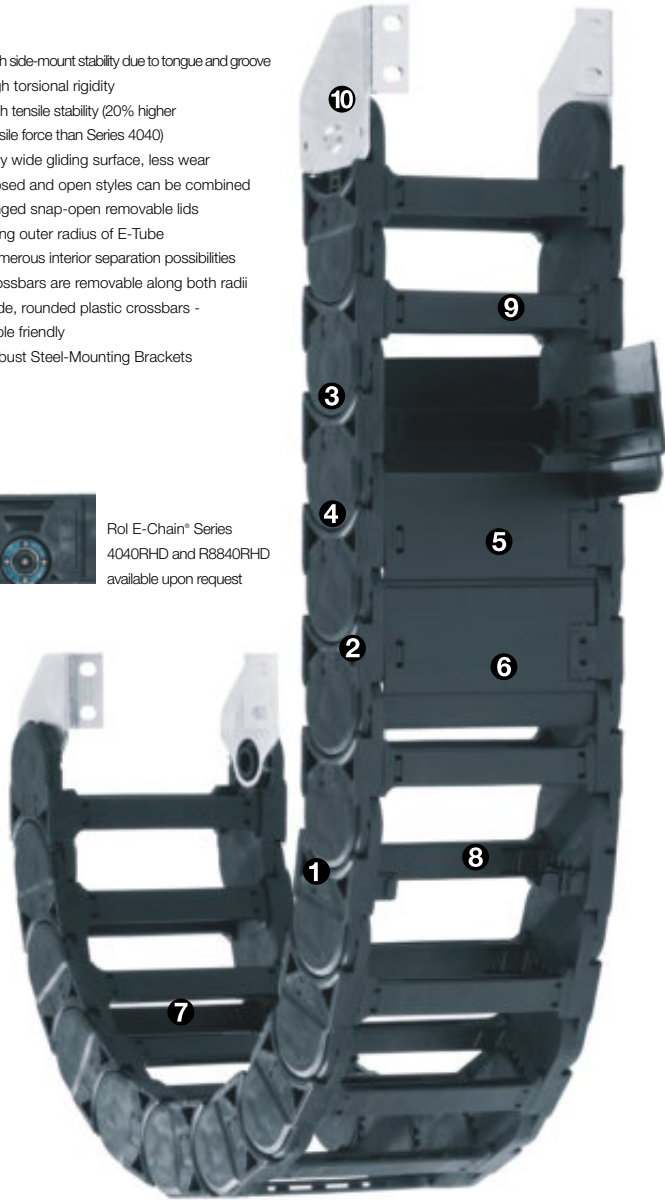

Order example complete E-Chain\*

Please indicate chain-lengths or number of links Example: 5 m or 55 links

5 m 4040HD.30.300.0

 E-Chain\*

with 2 separators 411 assembled every 2<sup>nd</sup> link

 Interior separation

1 set 4040HD.12.E

 Mounting bracket

**Unsupported length**

$FL_G$  = with straight upper run  
 $FL_B$  = with permitted sag  
 Further information ► **Design, page 1.12**

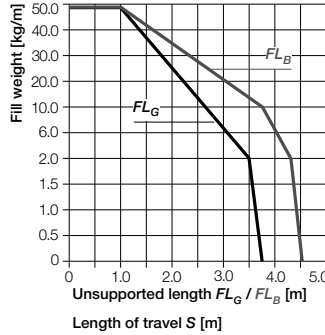
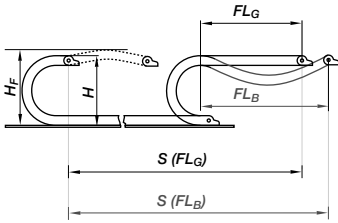

- $S$  = Length of travel
  - $R$  = Bending radius
  - $H$  = Nominal clearance height
  - $H_F$  = Required clearance height
  - $H_{in}$  = Trough inner height
  - $D$  = Overlength E-Chain\* radius in final position
  - $K = \pi \cdot R + \text{"safety"}$
  - $D_2$  = Over length - long travels, gliding
  - $K_2$  = \*Further add-on
  - $H_2$  = \*Mounting height
- \*If the mounting bracket location is set lower

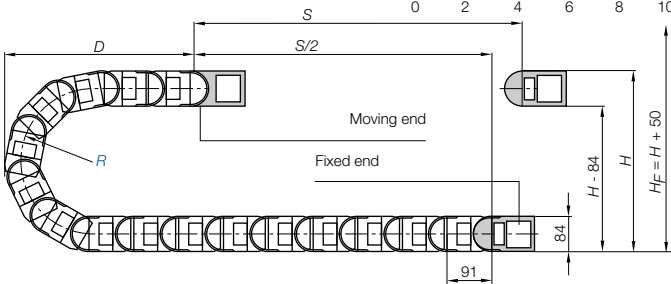

**Pitch = 91 mm/Glided    Links/m = 11 (1001 mm)    Chain length =  $S/2 + K$**

R	135	150	250	300
H	354	384	584	684
D	268	283	383	433
K	610	655	970	1125
$D_2$	-	480	800	1200
$K_2$	-	819	1638	2002
$H_2$	-	266	266	266



**Short travels - unsupported**

Unsupported E-Chains\* feature positive camber over short travels. This must be accounted for when specifying the clearance height  $H_F$ . Please consult igus\* if space is particularly restricted.

The required clearance height:  
 $H_F = H + 50$  mm  
 (with 3,0 kg/m fill weight)

**Long travel lengths from 10 m to max. 350 m    Chain length =  $S/2 + K_2$**

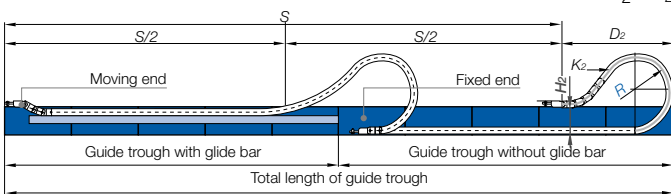

In case of travels between 4 and 10 m we recommend a longer unsupported length.



**Gliding, long travel applications (max. 350 m)**

In this case the E-Chain\* upper run will be introduced in a guide trough on the lower run. We recommend to realize the engineering of such a plant by our technicians.

Speed / acceleration $FL_G$	max. 20 [m/s] / max. 200 [m/s <sup>2</sup> ]
Speed / acceleration $FL_B$	max. 3 [m/s] / max. 6 [m/s <sup>2</sup> ]
Gliding speed / acceleration (maximum)	max. 10 [m/s] / max. 50 [m/s <sup>2</sup> ]
Material - permitted temperature °C	igumid G / -40° up to +120° C
Flammability class, igumid G	VDE 0304 IIC UL94 HB

**Technical Data**



Details of material properties  
 ► page 1.38

56

System E4/4  
 Inner height: 56 mm

Phone +49- (0) 22 03-96 49-800  
 Fax +49- (0) 22 03-96 49-222



► page 7.91

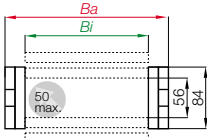

Part No. structure

4040HD. 30. 250. 0



Series 4040HD - E-Chain® with crossbars every link

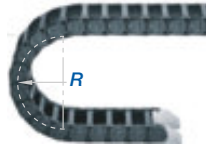

- Crossbars every link
- For highest additional loads
- For applications particularly demanding
- Can be opened from two sides

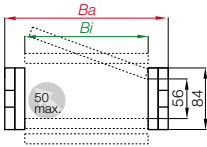

Part No. structure

8840HD. 30. 250. 0



Series R8840HD - Fully enclosed E-Tube

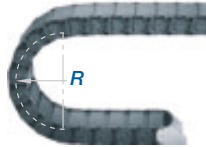

- Fully enclosed
- Excellent cable protection against dirt
- Protection against hot chips
- Lids along the entire inner radius are completely removable. Lids along the entire outer radius are single sided snap-open with a hinge on the other side to keep them attached to the chain or completely removable



igus® E-Chains® 4040RHD "Rol E-Chain™" in an igus® super-alu-trough = 75% less driving power



**Rol instead of gliding: Rol E-Chain®**

Special solution for long travels. 75% less drive power (gliding application) with igus® Rol E-Chain®. Series 4040R - Order example 4040RHD.30.250.0  
Further information: [www.igus.de/en/role](http://www.igus.de/en/role) or phone: +49-0 22 03-96 49-800



TIP!

Part No.		<i>Bi</i> [mm]	<i>Ba</i> [mm]	4040HD [kg/m]	R8840HD [kg/m]
4040HD/05.....	<input type="checkbox"/> .0	50	104	≈ 5,03	–
4040HD/06.....	<input type="checkbox"/> .0	65	119	≈ 5,12	–
4040HD/8840HD.07.....	<input type="checkbox"/> .0*	75	129	≈ 5,19	≈ 5,64
4040HD/8840HD.10.....	<input type="checkbox"/> .0	100	154	≈ 5,36	≈ 5,93
4040HD.11.....	<input type="checkbox"/> .0	112	166	≈ 5,48	–
4040HD/8840HD.12.....	<input type="checkbox"/> .0	125	179	≈ 5,56	≈ 6,29
4040HD.13.....	<input type="checkbox"/> .0	137	191	≈ 5,69	–
4040HD/8840HD.15.....	<input type="checkbox"/> .0	150	204	≈ 5,73	≈ 6,67
4040HD.16.....	<input type="checkbox"/> .0	162	216	≈ 5,84	–
4040HD.17.....	<input type="checkbox"/> .0	175	175	≈ 5,97	–
4040HD.18.....	<input type="checkbox"/> .0	187	241	≈ 6,09	–
4040HD/8840HD.20.....	<input type="checkbox"/> .0	200	254	≈ 6,14	≈ 7,29
4040HD.21.....	<input type="checkbox"/> .0	212	266	≈ 6,21	–
4040HD.22.....	<input type="checkbox"/> .0	225	279	≈ 6,28	–
4040HD.23.....	<input type="checkbox"/> .0	237	291	≈ 6,39	–
4040HD/8840HD.25.....	<input type="checkbox"/> .0	250	304	≈ 6,50	≈ 8,02
4040HD.26.....	<input type="checkbox"/> .0	262	316	≈ 6,59	–
4040HD/8840HD.27.....	<input type="checkbox"/> .0	275	329	≈ 6,70	≈ 8,38
4040HD.28.....	<input type="checkbox"/> .0	287	314	≈ 6,75	–
4040HD/8840HD.30.....	<input type="checkbox"/> .0	300	354	≈ 6,91	≈ 8,68
4040HD.31.....	<input type="checkbox"/> .0	312	366	≈ 6,94	–
4040HD.32.....	<input type="checkbox"/> .0	325	379	≈ 7,05	–
4040HD.33.....	<input type="checkbox"/> .0	337	391	≈ 7,17	–
4040HD/8840HD.35.....	<input type="checkbox"/> .0	350	404	≈ 7,37	≈ 9,38
4040HD.36.....	<input type="checkbox"/> .0	362	416	≈ 7,28	–
4040HD.37.....	<input type="checkbox"/> .0	375	429	≈ 7,38	–
4040HD.38.....	<input type="checkbox"/> .0	387	441	≈ 7,49	–
4040HD/8840HD.40.....	<input type="checkbox"/> .0	400	454	≈ 7,76	≈ 10,38
4040HD.41.....	<input type="checkbox"/> .0	412	466	≈ 7,68	–
4040HD.42.....	<input type="checkbox"/> .0	425	479	≈ 7,98	–
4040HD.43.....	<input type="checkbox"/> .0	437	491	≈ 7,82	–
4040HD.45.....	<input type="checkbox"/> .0	450	504	≈ 8,15	–
4040HD/8840HD.46.....	<input type="checkbox"/> .0	462	516	≈ 8,10	≈ 10,85
4040HD.47.....	<input type="checkbox"/> .0	475	529	≈ 8,14	–
4040HD.48.....	<input type="checkbox"/> .0	487	541	≈ 8,39	–
4040HD.50.....	<input type="checkbox"/> .0	500	554	≈ 8,48	–
4040HD.51.....	<input type="checkbox"/> .0	512	566	≈ 8,40	–
4040HD.52.....	<input type="checkbox"/> .0	525	579	≈ 8,57	–
4040HD.53.....	<input type="checkbox"/> .0	537	591	≈ 8,66	–
4040HD.55.....	<input type="checkbox"/> .0	550	604	≈ 9,08	–
4040HD.60.....	<input type="checkbox"/> .0	600	654	≈ 9,31	–

Available bending radii

R [mm]  135\*\*  150  250  300

Supplement Part No. with required radius. Example: 4040HD.30.300]0

0 = standard color, other colors ▶ page 1.39 · Pitch = 91 mm/link · Links/m = 11

\*Removable lid only, no hinged option · \*\*not available for R8840HD

**TIP!**

## Hot Chips up to 850°C

E-Tubes that repel hot chips, up to 850 °C  
Some applications, depending on amount and size of the chips, can burn or melt the surface. That is no longer the case with the new igus® "Igmuid HT" material.

Further information:  
www.igus.de/en/HT  
or phone:  
+49-0 22 03-96 49-800

System E4/4  
Inner height: 56 mm

Phone +49- (0) 22 03-96 49-800  
Fax +49- (0) 22 03-96 49-222



▶ page 7.91

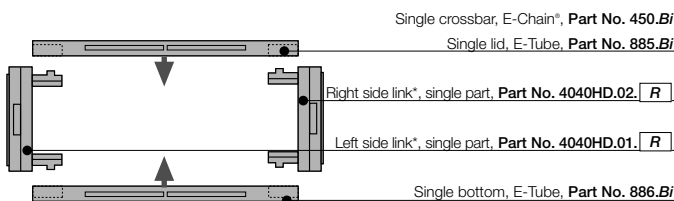

### Part No. E-Chain® - links, single parts

\*View from the fixed point of the E-Chain®/E-Tube



**Option 1**

- Vertical separators
- Spacers
- Locking separators
- Asymmetric separators

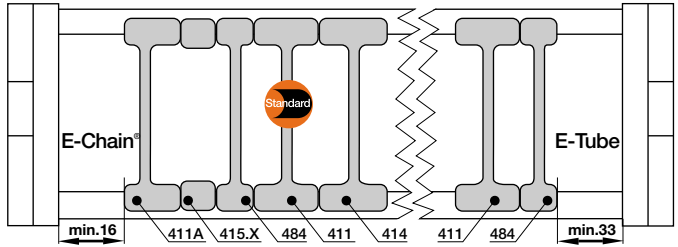

Vertical separator  
401



Vertical separator  
483



Spacer  
405.10



Spacer  
405.15



Spacer  
405.20



Spacer  
405.30



Spacer  
405.40



Locking separator  
404



Asymmetric  
separator 401A

<b>Vertical separator for E-Chains®/E-Tubes</b>	
unassembled	401
assembled	411



<b>Vertical separator for E-Chains®/E-Tubes</b>	
unassembled	483
assembled	484



<b>Spacer*</b>	
unassembled	405.10
assembled	415.10



<b>Spacer*</b> for E-Chains®	
unassembled	405.15
assembled	415.15



<b>Spacer*</b> for E-Chains®	
unassembled	405.20
assembled	415.20



<b>Spacer*</b> for E-Chains®	
unassembled	405.30
assembled	415.30



<b>Spacer*</b> for E-Chains®	
unassembled	405.40
assembled	415.40



<b>Locking separator for E-Chains®</b>	
unassembled	404
assembled	414



<b>Asymmetric separator for E-Chains®</b>	
unassembled	401A
assembled	411A



\*For side-mounted applications

**Option 1: Vertical separators and spacers**

Vertical separators are used if a vertical subdivision of the E-Chain® interior is required - By standard vertical separators are assembled every other E-Chain® link. **Note:** Observe a lateral spacing of at least 16 mm for E-Chains® and at least 33 mm for E-Tubes!

● **Standard separator 401 for E-Chains® and E-Tubes** offers safe stability due to its wide base design, also when used with thick cables or hoses

● **Vertical separator 483 with a narrow base for E-Chains® and E-Tubes** with applications where a large number of small cables need to be individually separated

● **Vertical separators in side-mounted applications**, for instance, can be fixed in position by means of **spacer 405.X for E-Chains®**. A wide range of intervals between the vertical separators is adjustable here

● **Note on spacers:** The available interior height is reduced by 2 mm per spacer (4 mm when spacers are fitted on both sides)

**Additionally:**

● **Locking separator 404 for E-Chains®** - with increased retention force for applications exposed to very high humidity or extreme loads. The extra retention force is achieved by asymmetric claws for the crossbar. Ensure proper alignment

● **Locking separator 406 for E4-Tubes** - safe fitting locked on lid or bottom of the Tube and sideways slideable. The opposing lid or bottom can easily be opened and closed. Especially capable if many separators need to be assembled on a tight inner width.

**Part. No. not assembled 406 - Part. No. assembled 416.** For illustration, refer to **vertical separator 404**.

● **Asymmetric separator 401A for E-Chains®** (not for E-Tubes) with an 18-mm base, for combinations between spacers of different widths and vertical separators in side-mounted applications, for instance



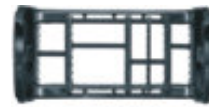
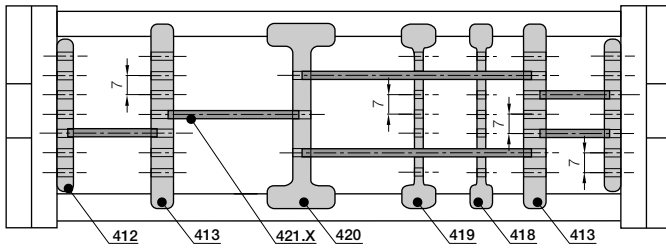

**Option 2**

- Side plates
- Middle plates
- Locking vertical separators
- Slotted separators
- Open slotted separators

**Option 2: Shelves**

For applications involving many cables with different diameters. The shelves can be arranged elevator-shifted with different bottoms.

- Side plates 402, middle plates 403 and shelves 420.X form the basic pattern of a shelf system. Shelves of various widths can be arranged at 7 different heights (in 7 mm increments)

- Locking vertical separator 410, slotted combined with shelves.

- Slotted separators 408, are used for very fine subdivisions. However, they cannot be retrofitted into an existing separation system without dismantling the interior separators first

- The unilateral open slotted separator 409 can be retrofitted into an existing interior separation system without a need for dismantling the interior separators. During an installation of open slotted separators, the top and bottom notches cannot be occupied by shelves

	<b>Side plate for E-Chains®/E-Tubes</b>
	unassembled 402 assembled 412

	<b>Middle plate for E-Chains®/E-Tubes</b>
	unassembled 403 assembled 413

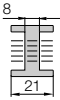
	<b>Locking vertical separator for E-Chains®/E-Tubes</b>
	unassembled 410 assembled 420

	<b>Slotted separator for E-Chains®/E-Tubes</b>
	unassembled 408 assembled 418

	<b>Open slotted separator for E-Chains®/E-Tubes</b>
	unassembled 409 assembled 419

	Side plate 402
---	-------------------

	Middle plate 403
---	---------------------

	Locking Vertical separator 410
---	-----------------------------------

	Slotted separator 408
---	--------------------------

	Open slotted separator 409
--	-------------------------------

	Shelf 420.X
---	-------------

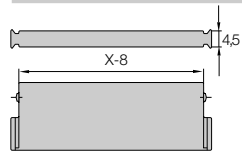

Width X [mm]	Part No. unassembled	Part No. assembled
18	420.18	421.18
23	420.23	421.23
25	420.25	421.25
28	420.28	421.28
33	420.33	421.33
43	420.43	421.43
50	420.50	421.50
62	420.62	421.62

Width X [mm]	Part No. unassembled	Part No. assembled
75	420.75	421.75
88	420.88	421.88
100	420.100	421.100
125	420.125	421.125
150	420.150	421.150
175	420.175	421.175
187	420.187	421.187
200	420.200	421.200

**Additional elements for interior separation**

	<b>Center crossbar</b>
	unassembled 405 assembled 415

**Center crossbar** - was developed for applications with a large number of thin cables. The center crossbar offers the option of subdividing the E-Chain® independently into upper and lower halves.

	<b>Rollclip</b>
	unassembled 489.27 assembled 490.27

**Rollclip** - minimizes abrasion of particularly sensitive hoses. The Rollclip is simply clamped onto the opening crossbar. The movable rollers compensate for relative movement between the chain and hose.

	<b>Roller separator</b>
	unassembled 429 assembled 430

**Roller separator** - performs a similar function to the Rollclip, but doubles as a separator.

System E4/4  
Inner height: 56 mm

Phone +49- (0) 22 03-96 49-800  
Fax +49- (0) 22 03-96 49-222

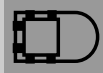

▶ page 7.91

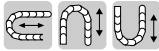

**Option steel - pivoting**

- For pivoting connections
- One part (two-piece) for all chain widths
- Electrically conductive

Moving end  
40400HD.1.E

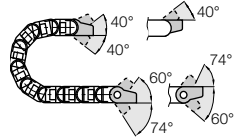

Fixed end  
40400HD.2.E

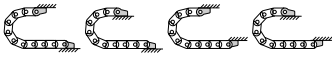

Possible installation conditions -

Further installation angles ► installation sketch

Phone +49- (0) 22 03-96 49-800  
Fax +49- (0) 22 03-96 49-222

igus® GmbH  
51147 Cologne

Moving end  
40400HD.1.E

Fixed end  
40400HD.2.E

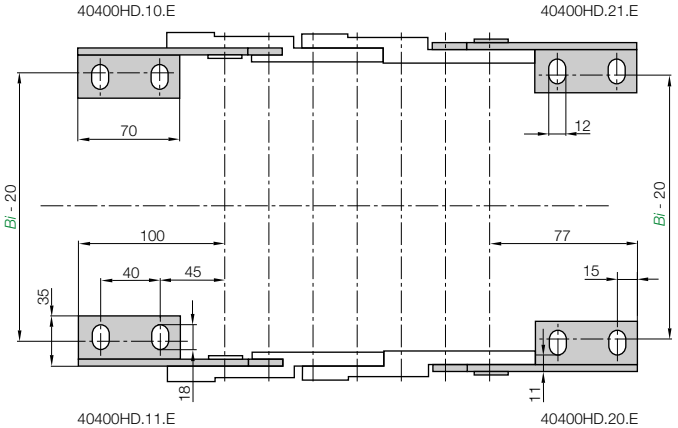

40400HD. 12 .E Full set, 4 parts  
2 with pin / 2 with bore

Single-part order:

- 40400HD. 1 .E Mounting bracket with bore, 1 part left / right
- 40400HD. 2 .E Mounting bracket with pin, 1 part left / right

Part No.	Mounting bracket
40400HD. 12 .E	Full set, 4 parts, 2 with pin / 2 with bore
40400HD. 1 .E	Mounting bracket with bore, 1 part left / right
40400HD. 2 .E	Mounting bracket with pin, 1 part left / right

E4/4 | Series 4040HD·R8840HD | Accessories | Strain Relief

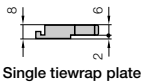
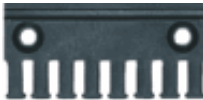

Single tie-wrap plate

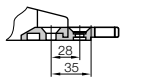

Shown assembled

**Tie-wrap plate as individual part**

As individual component screwed on KMA. Can be plugged in the mounting brackets. **Details ► chapter 10**

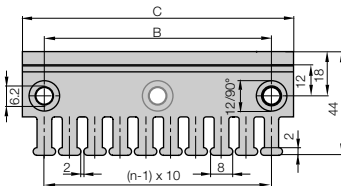

Tie-wrap plate	No. of teeth n	Dim. C [mm]	Dim. B [mm]	Center bore
3050.ZB	5	50	30	-
3075.ZB	7	75	55	-
3100.ZB	10	100	80	-
3115.ZB	11	115	95	-
3125.ZB	12	125	105	-
3150.ZB	15	150	130	-
3175.ZB	17	175	155	-
3200.ZB	20	200	180	+
3225.ZB	22	225	205	+
3250.ZB	25	250	230	+

(- = no / + = yes)

Internet: [www.igus.de](http://www.igus.de)  
E-mail: [info@igus.de](mailto:info@igus.de)

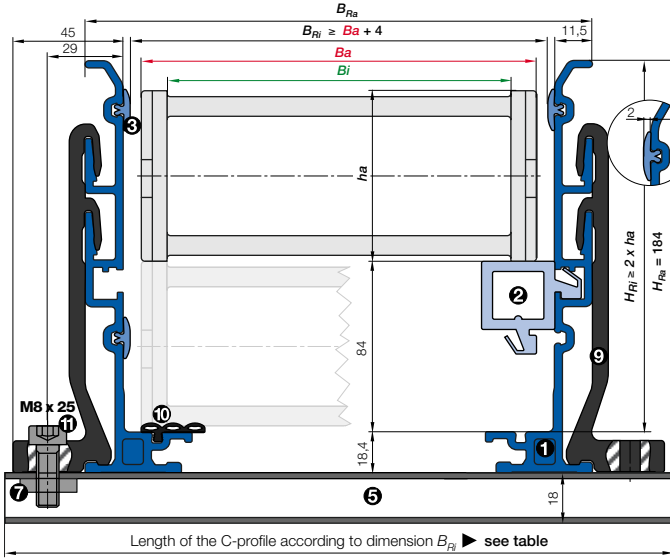

- **Components, trough "Heavy Duty":** ① Trough side parts, aluminum, 2 m ② Glide bar, plastic, 2 m ③ Glide strips, plastic, 2 m (without glide strips on request) ⑩ Optional: Silencer profile, rubber
- **Components, installation set "Heavy Duty":** ⑤ C-profile, steel galvanized ⑦ Sliding nut M6 ⑨ Installation angle bracket "Heavy Duty", Aluminium ⑪ Screw M6 x 20



**Order example: Length of travel 30 m - Center mounted for Series 4040HD.10.250.0 with  $B_{Ri} = 158$**

Guide trough set (set of 2 trough side parts, incl. glide strips) <b>without</b> glide bar	Part No.	974.30.SL
Order text: 16 m guide trough without glide bar (8 x 2 m sections)		
Guide trough set (set of 2 trough side parts, incl. glide strips) <b>with</b> glide bar	Part No.	974.31.SL
Order text: 16 m guide trough with glide bar (8 x 2 m sections)		
Installation set "Basic" complete (guide trough-sets + 1)	Part No.	974.50.275
Order text: 17 installation sets "Basic"		
Module for the fixed end	Part No.	974.80
Order text: 1 set		
Option: For an additional noise dampening with silencer profile, please add Index A - Example:	Part No.	974.30.SLA

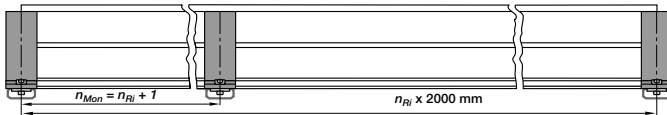

Principle sketch: Number of installation sets to be installed = Number of trough sections + 1

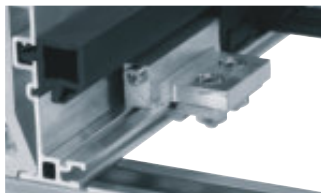

**NEW! A quick fix for mounting the stationary end of an E-Chain®**

With this new module for the fixed end, fast and easy mounting onto the Aluminum "SuperTrough" is now possible without any drilling. Fast mounting of the E-Chain® to the aluminum trough

- Quick relocation of the stationary end
- No drilling necessary ▶ page 9.16

- $B_a$  = Outer width E-Chains® / E-Tube
- $B_i$  = Inner width E-Chains® / E-Tube
- $h_a$  = Outer height E-Chains® / E-Tube
- $H_{Ri}$  = Inner trough height
- $H_{Ra}$  = Outer trough height
- $B_{Ri}$  = Inner trough width ▶ depends on dim.  $B_a$
- $B_{Ra}$  = Outer trough width
- $n_{Mon}$  = Number of installation sets (left/right)
- $n_{Ri}$  = Number of trough sets (left/right)
- $H_{Ri} \geq 2 \cdot h_a$
- $B_{Ri} \geq B_a + 4$
- = Guide trough set      ● = Installation set "Basic"
- = Glide bar      ● = C-profile

**Installation set Heavy-Duty with C-profile**

4040HD.05.250.0 ▶ Order example

$B_{Ri}$ [mm]	Part No. assembled
.05	108 974.50.225
.06	123 974.50.250
.07	133 974.50.250
.10	158 974.50.275
.11	170 974.50.300
.12	183 974.50.300
.13	195 974.50.325
.15	208 974.50.325
.16	220 974.50.350
.17	233 974.50.350
.18	245 974.50.375
.20	258 974.50.375
.21	270 974.50.400
.22	283 974.50.400
.23	295 974.50.425
.25	308 974.50.425
.26	320 974.50.450
.27	333 974.50.450
.28	345 974.50.475
.30	358 974.50.475
.31	370 974.50.500
.32	383 974.50.500
.33	395 974.50.525
.35	408 974.50.525
.36	420 974.50.550
.37	433 974.50.550
.38	445 974.50.575
.40	458 974.50.575
.41	470 974.50.600
.42	483 974.50.600
.43	495 974.50.625
.45	508 974.50.625
.46	520 974.50.650
.47	533 974.50.650
.48	545 974.50.675
.50.^\	558 974.50.675
.51	570 974.50.700
.52	583 974.50.700
.53	595 974.50.725
.55	608 974.50.725
.60	658 974.50.775

Phone +49- (0) 22 03-96 49-800  
 Fax +49- (0) 22 03-96 49-222



▶ page 7.91

Price index



Side-mounted -  
unsupported



ESD classification:  
Electrically conductive ESD/ATEX  
version upon request



High torsional  
rigidity



Opening E-Chains®: Remove crossbars and clips - Insert screwdriver into the slot, push down, release by lever action



Remove lids/bottoms (E-Tubes) - Insert screwdriver into the slot, release by lever action



When to use the Series 5050/5150/R9850:

- When high torsional forces are expected
- For side-mounted applications involving large unsupported lengths
- Due to very dirt and dusty environment
- Also available as Rol E-Chain®



When not to use it:

- When very long travels or high additional loads are involved  
▶ Series 5050HD, page 7.148
- If a simple and low-cost solution is required  
▶ Series 15050/R19850, page 7.182

- 1 High side-mount stability due to tongue and groove
- 2 High torsional rigidity
- 3 Closed and open styles can be combined
- 4 Hinged snap-open removable lids of E-Tube
- 5 Numerous interior separation possibilities
- 6 Crossbars on E-Chains® are removable along both radii
- 7 Lateral glide surfaces for side-mounted operation
- 8 Wide, rounded plastic crossbars - cable friendly
- 9 KMA mounting brackets with attachment points on all sides
- 10 Mounting brackets with integrated strain relief available, locking or pivoting
- 11 E-Chains® also available with reverse bending radius "RBR"

! New "Heavy-Duty" size available. Greater unsupported length for higher loads and travels. Also available as Rol E-Chain® version



Rol E-Chain® Series  
5050R/9850R available  
upon request

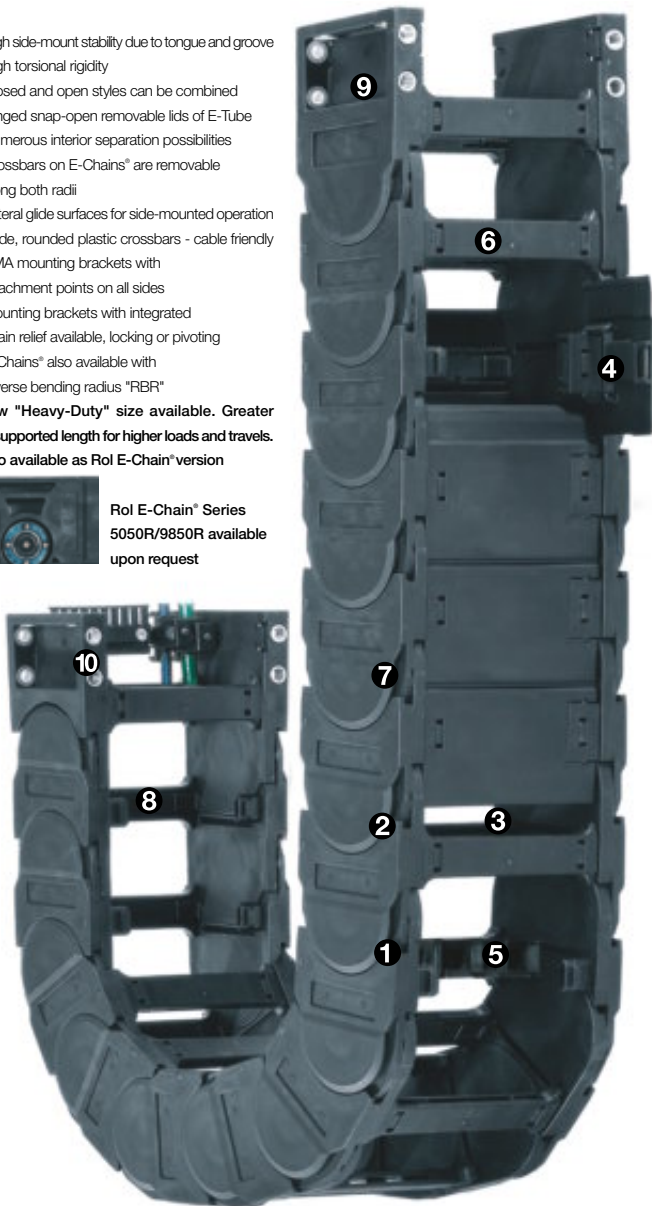

Order example complete E-Chain®

Please indicate chain-lengths or number of links Example: 5 m or 55 links

5 m 5050.30.300.0	E-Chain®
with 2 separators 511 assembled every 2 <sup>nd</sup> link	Interior separation
1 set 50500.30.12C	Mounting bracket

**Unsupported length**

$FL_G$  = with straight upper run

$FL_B$  = with permitted sag

Further information ► **Design, page 1.12**

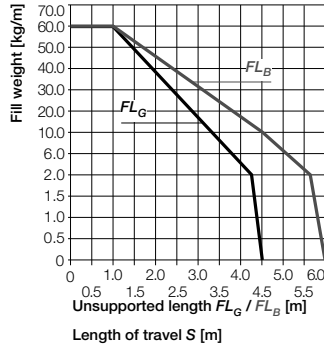
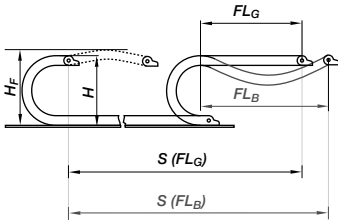

- $S$  = Length of travel
- $R$  = Bending radius
- $H$  = Nominal clearance height
- $H_F$  = Required clearance height
- $H_{in}$  = Trough inner height
- $D$  = Overlength E-Chain® radius in final position
- $K = \pi \cdot R + \text{"safety"}$
- $D_2$  = Over length - long travels, gliding
- $K_2$  = "Further add-on"
- $H_2$  = "Mounting height"

**Other installation methods**

- Vertical, hanging  $\leq 120$  m
- Vertical, standing  $\leq 6$  m
- Side mounted, unupp.  $\leq 3$  m
- Rotary requires further calculation
- Unsupported length of upper run = upon request

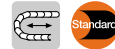

**Short travels - unsupported**

Unsupported E-Chains® feature positive camber over short travels. This must be accounted for when specifying the clearance height  $H_F$ . Please consult igus® if space is particularly restricted.

The required clearance height:  
 $H_F = H + 60$  mm  
(with 3,0 kg/m fill weight)

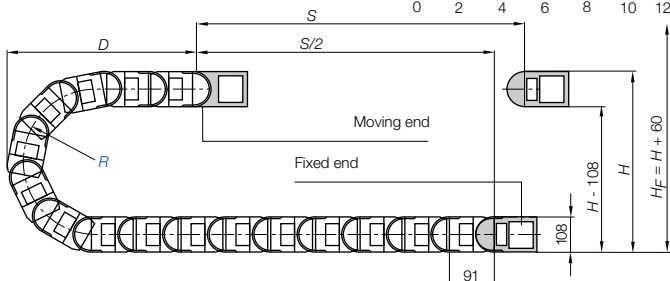

Pitch = 91 mm/link    Links/m = 11 (1001 mm)    Chain length =  $S/2 + K$

R	150	200	250	300	350	400	500	550	600	650	1000
$H_{+25}$	408	508	608	708	808	908	1108	1208	1308	1408	2108
D	295	345	395	445	495	545	645	695	745	795	1145
K	655	815	970	1125	1285	1440	1755	1910	2070	2225	3255
$D_2^{+25}$	550	800	950	1200	1550	1700	2157	2355	2580	-	-
$K_2$	910	1274	1638	2002	2457	2730	3458	3640	4459	-	-
$H_2$	242	242	242	242	242	242	242	242	242	-	-

**Long travel lengths from 10 m to max. 400 m    Chain length =  $S/2 + K_2$**

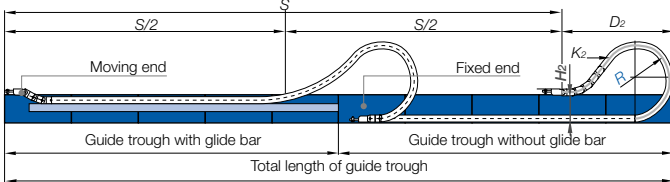

In case of travels between 4 and 10 m we recommend a longer unsupported length.



**Gliding, long travel applications (max. 400 m)**

In this case the E-Chain® upper run will be introduced in a guide trough on the lower run. We recommend to realize the engineering of such a plant by our technicians.

Speed / acceleration $FL_G$	max. 20 [m/s] / max. 200 [m/s²]
Speed / acceleration $FL_B$	max. 3 [m/s] / max. 6 [m/s²]
Gliding speed / acceleration (maximum)	max. 10 [m/s] / max. 50 [m/s²]
Material - permitted temperature °C	igumid G / -40° up to +120° C
Flammability class, igumid G	VDE 0304 IIC UL94 HB

**Technical Data**



Details of material properties  
► page 1.38



System E4/4  
Inner height: 80 mm

Phone +49- (0) 22 03-96 49-800  
Fax +49- (0) 22 03-96 49-222



► page 7.91

igus® E-ChainSystems®

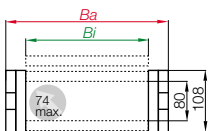

Part No. structure

5050. 30. 300. 0



Series 5050 - E-Chain® with crossbars every link

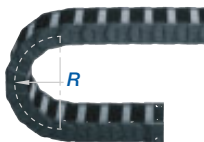

- Crossbars every link
- For rigid hydraulic hoses
- For applications particularly demanding
- Can be opened from two sides



Phone +49- (0) 22 03-96 49-800  
Fax +49- (0) 22 03-96 49-222

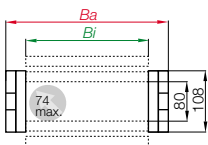

Part No. structure

5150. 30. 300. 0



Series 5150 - E-Chain® with crossbars every 2<sup>nd</sup> link

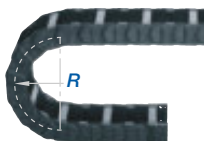

- Crossbars every 2<sup>nd</sup> link = Standard
- For nearly every situation
- Can be opened from two sides
- Easy assembly
- Stable
- Attractive price



igus® GmbH  
51147 Cologne

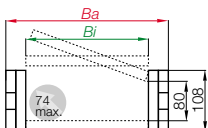

Part No. structure

9850. 30. 300. 0



Series R9850 - Fully enclosed E-Tube

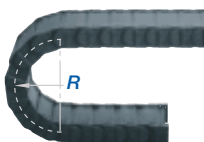

- Fully enclosed
- Excellent cable protection against dirt
- Protection against hot chips (up to 900°C)
- Lids along the entire inner radius are completely removable. Lids along the entire outer radius are single sided snap-open with a hinge on the other side to keep them attached to the chain or completely removable.



Internet: [www.igus.de](http://www.igus.de)  
E-mail: [info@igus.de](mailto:info@igus.de)

Rol instead of gliding: Rol E-Chain®

Special solution for long travels. 75% less drive power (gliding application) with igus® Rol E-Chain®. Series 5050R and 9850R - Order example 5050R.30.300.0 Further information: [www.igus.de/en/role](http://www.igus.de/en/role) or phone: +49-0 22 03-96 49-800



TIP!

Part No.	<i>Bi</i> [mm]	<i>Ba</i> [mm]	5050 [kg/m]	5150 [kg/m]	R9850 [kg/m]	
5050/5150.05.	.0	50	100	≈ 5,63	≈ 5,62	-
5050/5150.06.	.0	65	115	≈ 5,70	≈ 5,68	-
5050/5150/9850.07.	.0*	75	125	≈ 5,79	≈ 5,70	≈ 6,24
5050/5150/9850.10.	.0	100	150	≈ 5,96	≈ 5,79	≈ 6,52
5050/5150.11.	.0	112	163	≈ 6,09	≈ 5,85	-
5050/5150/9850.12.	.0	125	175	≈ 6,16	≈ 5,89	≈ 6,89
5050/5150.13.	.0	137	188	≈ 6,29	≈ 5,95	-
5050/5150/9850.15.	.0	150	200	≈ 6,36	≈ 5,98	≈ 7,32
5050/5150.16.	.0	162	213	≈ 6,47	≈ 6,04	-
5050/5150.17.	.0	175	225	≈ 6,58	≈ 6,09	-
5050/5150.18.	.0	187	238	≈ 6,69	≈ 6,15	-
5050/5150/9850.20.	.0	200	250	≈ 6,71	≈ 6,16	≈ 7,89
5050/5150.21.	.0	212	263	≈ 6,82	≈ 6,22	-
5050/5150.22.	.0	225	275	≈ 6,89	≈ 6,25	-
5050/5150.23.	.0	237	288	≈ 7,02	≈ 6,31	-
5050/5150/9850.25.	.0	250	300	≈ 7,11	≈ 6,36	≈ 8,61
5050/5150.26.	.0	262	313	≈ 7,19	≈ 6,40	-
5050/5150/9850.27.	.0	275	325	≈ 7,30	≈ 6,46	≈ 8,82
5050/5150.28.	.0	287	338	≈ 7,33	≈ 6,47	-
5050/5150/9850.30.	.0	300	350	≈ 7,55	≈ 6,58	≈ 9,27
5050/5150.31.	.0	312	363	≈ 7,58	≈ 6,60	-
5050/5150.32.	.0	325	375	≈ 7,63	≈ 6,62	-
5050/5150.33.	.0	337	388	≈ 7,81	≈ 6,71	-
5050/5150/9850.35.	.0	350	400	≈ 7,96	≈ 6,79	≈ 10,02
5050/5150.36.	.0	362	413	≈ 7,97	≈ 6,80	-
5050/5150.37.	.0	375	425	≈ 7,99	≈ 6,80	-
5050/5150.38.	.0	387	438	≈ 8,07	≈ 6,84	-
5050/5150/9850.40.	.0	400	450	≈ 8,27	≈ 6,94	≈ 10,98
5050/5150.41.	.0	412	463	≈ 8,43	≈ 7,02	-
5050/5150.42.	.0	425	475	≈ 8,58	≈ 7,10	-
5050/5150.43.	.0	437	488	≈ 8,65	≈ 7,13	-
5050/5150.45.	.0	450	500	≈ 8,71	≈ 7,16	-
5050/5150/9850.46.	.0	462	513	≈ 8,73	≈ 7,17	≈ 11,44
5050/5150.47.	.0	475	525	≈ 8,87	≈ 7,24	-
5050/5150.48.	.0	487	538	≈ 8,88	≈ 7,26	-
5050/5150.50.	.0	500	550	≈ 9,00	≈ 7,30	-
5050/5150.51.	.0	512	563	≈ 9,02	≈ 7,32	-
5050/5150.52.	.0	525	575	≈ 9,06	≈ 7,34	-
5050/5150.53.	.0	537	588	≈ 9,22	≈ 7,41	-
5050/5150.55.	.0	550	600	≈ 9,70	≈ 7,66	-
5050/5150.60.	.0	600	650	≈ 9,90	≈ 7,76	-

Available bending radii

R [mm] **150°** 200 250 300 350 400 500 550 600 650 1000

Supplement Part No. with required radius. Example: 5050.30.**300**.0

0 = standard color, other colors ▶ page 1.39 · Pitch = 91 mm/link - Links/m = 11

\*not available for R9850

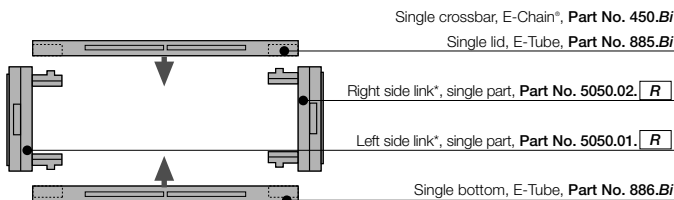

TIP!

### Hot Chips up to 850°C

E-Tubes that repel hot chips, up to 850 °C  
 Some applications, depending on amount and size of the chips, can burn or melt the surface. That is no longer the case with the new igus® "Igmuid HT" material.

Further information:  
[www.igus.de/en/HT](http://www.igus.de/en/HT)  
 or phone:  
 +49-0 22 03-96 49-800



System E4/4  
 Inner height: 80 mm

TIP!

### Extreme Glider..

with up to 70% larger glide surface. For high additional loads and high gliding speeds. Gliding applications without additional elements as well as 150% more wear allowance and improvement of service life by factor 4!

Order example:  
 5050.35G.250.0  
 5050.45G.250.0

Further information:  
 phone +49-0 22 03-96 49-800

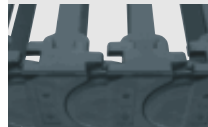

### Part No. E-Chain® - links, single parts

\*View from the fixed point of the E-Chain®/E-Tube



▶ page 7.91





**Option 1**

- Vertical separators
- Spacers
- Locking separators
- Asymmetric separators

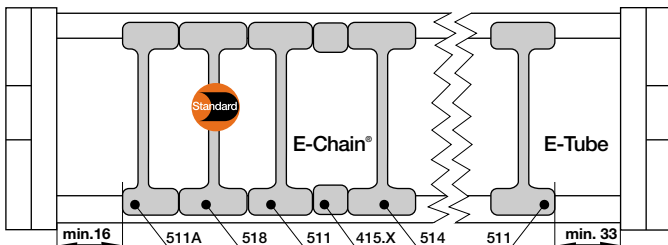

Vertical separator  
501



Spacer  
405.10



Spacer  
405.15



Spacer  
405.20



Spacer  
405.30



Spacer  
405.40



Locking separator  
504



Locking separator  
508



Asymmetric  
separator 501A

**Vertical separator  
for E-Chains®/E-Tubes**

unassembled	501
assembled	511



**Spacer\*  
for E-Chains®**

unassembled	405.10
assembled	415.10



**Spacer\*  
for E-Chains®**

unassembled	405.15
assembled	415.15



**Spacer\*  
for E-Chains®**

unassembled	405.20
assembled	415.20



**Spacer\*  
for E-Chains®**

unassembled	405.30
assembled	415.30



**Spacer\*  
for E-Chains®**

unassembled	405.40
assembled	415.40



**Locking separator  
for E-Chains®**

unassembled	504
assembled	514



**Locking separator  
for E-Chains®**

unassembled	508
assembled	518



**Asymmetric separator  
for E-Chains®**

unassembled	501A
assembled	511A



\*For side-mounted applications

**Option 1: Vertical separators and spacers**

Vertical separators are used if a vertical subdivision of the E-Chain® interior is required - By standard vertical separators are assembled every other E-Chain® link. **Note:** Observe a lateral spacing of at least 16 mm! Exception: No minimum spacing is needed for side plates.

● **Standard separator 501 for E-Chains® and E-Tubes** offers safe stability due to its wide base design, also when used with thick cables or hoses.

● Vertical separators in side-mounted applications, for instance, can be fixed in position by means of **spacer 405.X for E-Chains®**. A wide range of intervals between the vertical separators is adjustable here.

● **Note on spacers:** The available interior height is reduced by 2 mm per spacer (4 mm when spacers are fitted on both sides). To avoid this, the parts can also be installed from the outside on the opening crossbar.

**Additionally:**

● **Locking separator for E-Chains® 504-** with increased retention force for applications exposed to very high humidity or extreme loads. If locking separators are used, the E-Chain® is more difficult to open

● The **Locking separator for E-Chains® 508** is designed for applications exposed to extremely high humidity, for example, at composting plants. The lateral cam serves for uniform alignment of the vertical separators; if these separators are misaligned, they will inevitably get damaged on an attempt to open the E-Chain®.

● **Asymmetric separator 501A for E-Chains®** (not for E-Tubes) with an 18-mm base, for combinations between spacers of different widths and vertical separators in side-mounted applications, for instance.

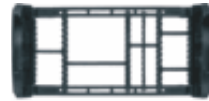
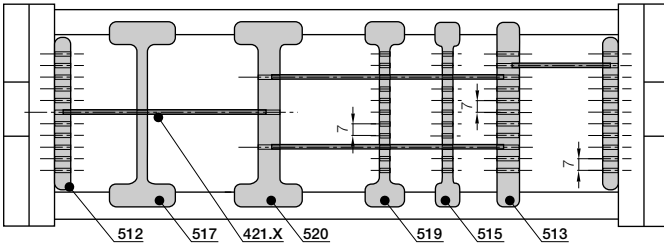

**Option 2**

- Side plates
- Middle plates
- Locking vertical separator
- Locking separators
- Slotted separators
- Open slotted separators

**Option 2: Shelves**

For applications involving many cables with different diameters. The shelves can be arranged elevator-shifted with different bottoms.

● Side plates 502, middle plates 503 and shelves 420.X form the basic pattern of a shelf system. Shelves of various widths can be arranged at 11 different heights (in 7 mm increments).

● Locking vertical separator 510 combined with shelves. Triple slots.

● Locking separator 507 slotted - with increased retention force for applications exposed to very high humidity or extreme loads. The extra retention force is achieved by asymmetric claws for the crossbar. Ensure proper alignment.

● Slotted separators 505 are used for very fine subdivisions. However, they cannot be retrofitted into an existing separation system without dismantling the interior separators first.

● The unilateral open slotted separator 509 can be retrofitted into an existing interior separation system without a need for dismantling the interior separators. During an installation of open slotted separators, the top and bottom notches cannot be occupied by shelves.

**Side plate for E-Chains®/E-Tubes**

unassembled	502
assembled	512

**Middle plate for E-Chains®/E-Tubes**

unassembled	503
assembled	513

**Locking vertical separator for E-Chains®/E-Tubes**

unassembled	510
assembled	520

**Locking separator for E-Chains®**

unassembled	507
assembled	517

**Slotted separator for E-Chains®/E-Tubes**

unassembled	505
assembled	515

**Open slotted separator for E-Chains®/E-Tubes**

unassembled	509
assembled	519

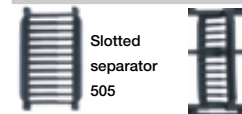

Width X [mm]	Part No. unassembled	Part No. assembled
18	420.18	421.18
23	420.23	421.23
25	420.25	421.25
28	420.28	421.28
33	420.33	421.33
43	420.43	421.43
50	420.50	421.50
62	420.62	421.62

Width X [mm]	Part No. unassembled	Part No. assembled
75	420.75	421.75
88	420.88	421.88
100	420.100	421.100
125	420.125	421.125
150	420.150	421.150
175	420.175	421.175
187	420.187	421.187
200	420.200	421.200

**Shelf 420.X**

**Additional elements for interior separation**

Rollclip	unassembled	assembled
	489.27	490.27

**Rollclip** - minimizes abrasion of particularly sensitive hoses. The Rollclip is simply clamped onto the opening crossbar. The movable rollers compensate for relative movement between the chain and hose.



System E4/4  
Inner height: 80 mm

Phone +49- (0) 22 03-96 49-800  
Fax +49- (0) 22 03-96 49-222

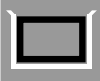

▶ page 7.91

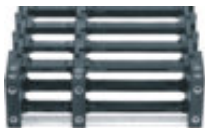

### Extension links - for extremely wide E-Chains® up to 3,0 m

- For applications in which particularly high fill weights necessitate extremely wide E-Chains® (up to 3000 mm)
- The extension link design allows virtually limitless side-by-side attachment of chains
- The unsupported length of a chain can be increased when additional loads are required
- Extension links can be used with E-Chains®, E-Tubes or as a combination of both
- They are suitable for unsupported and gliding applications in a guide trough
- E-Chains® with extension links are attached with KMA or steel mounting brackets



Part No. structure  
5050.10 /20 /10. 200.0  
5050.Bi1/Bi2/Bi3. R 1.0

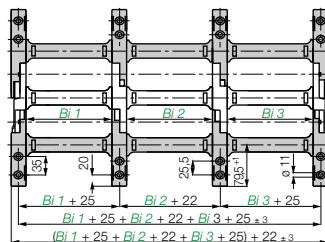

### Extender crossbars - careful guide of hoses applications

- Suitable for hoses with a maximum outer diameter of 300 mm
- Gliding operation with crossbars assembled along the outer radius and a special guide trough
- Gliding operation not guaranteed with crossbars assembled along the inner radius
- The extender crossbar can either be attached to the side links directly or can be used in combination with two stranded snap-open crossbars

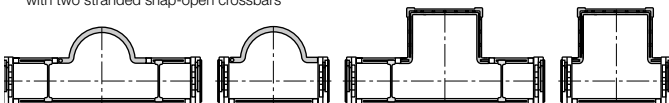

Consult igus® for your extender crossbar applications. We are happy to assist you with your design layout

Round extender crossbar with snap-open crossbars    Attached directly to the side link    Square extender crossbar with snap-open crossbars    Attached directly to the side link

Part No.	Max Ø [mm] hose	Form	Installation side link	Combination with snap-open crossb.
450.15.RHD115	115	○	-	+
450.17.RD115	115	○	+	-
450.25.D150	150	□	+	-
450.30.D200	200	□	+	-
450.35.D250	220	□	+	-
450.40.D300	270	□	+	-
450.20.HD150	150	□	-	+
450.25.HD200	200	□	-	+
450.30.HD250	270	□	-	+

○ = round    □ = square    + = yes / - = no



### E4 clip-on cable binder

- For side-mounted applications    ● Serves as a clip-on, lateral guide for hoses and cables on E-Chains®
- The loops can be adjusted as required    ● Compatible with many E4 E-Chains®    ● Stylish and economical
- One clip and one locking band are needed for each chain link    ● Call us if you have any questions on project planning

Part No.	Form
450.B12	Locking clip, comprising a locking element
450.B12.200	Locking band, comprising a locking element and band; 12 x 1,5 x 200 mm

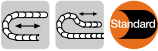

### The Standard - Option KMA\* - pivoting

- Recommended for unsupported and gliding applications
- Confined installation conditions
- Option - integrated C-profile strain relief device with Chainfix clip or strain relief tiwrap plates
- Corrosion resistant
- Universal mountable with attachment capability on all sides

\*KMA = Polymer Metal Mounting Bracket

Moving end  
50500/98500...1

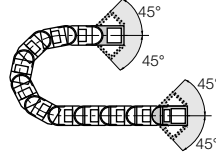

Fixed end  
50500/98500...2



The attachment variants arising automatically by the choice of the KMA mounting bracket

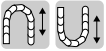
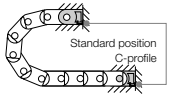

### Option KMA - locking

- Recommended for vertical hanging / standing applications

Additionally:

- Universal mountable
- C-profile option
- Corrosion resistant
- Locked connections
- At very high acceleration

Moving end  
51500/99500...1

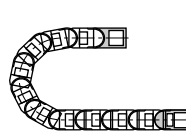

Fixed end  
51500/99500...2



The attachment variants arising automatically by the choice of the KMA mounting bracket

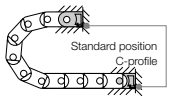

Fixed end 50500/98500...2 (pivoting)  
51500/99500...2 (locking)      Moving end 50500/98500...1 (pivoting)  
(locking) 51500/99500...1

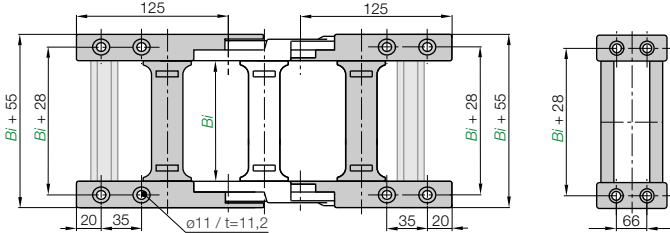

index	Part No. full set		C-profile option [mm]	Bi	index	Part No. full set		C-profile option [mm]	Bi
	pivoting	locking				pivoting	locking		
.05.	50500	51500	.05.12. C	50	.32.	50500	51500	.32.12. C	325
.06.	50500	51500	.06.12. C	65	.33.	50500	51500	.33.12. C	337
.07.	50500/98500	51500/99500	.07.12. C	75	.35.	50500/98500	51500/99500	.35.12. C	350
.10.	50500/98500	51500/99500	.10.12. C	100	.36.	50500	51500	.36.12. C	362
.11.	50500	51500	.11.12. C	112	.37.	50500	51500	.37.12. C	375
.12.	50500/98500	51500/99500	.12.12. C	125	.38.	50500	51500	.38.12. C	387
.13.	50500	51500	.13.12. C	137	.40.	50500/98500	51500/99500	.40.12. C	400
.15.	50500/98500	51500/99500	.15.12. C	150	.41.	50500	51500	.41.12. C	412
.16.	50500	51500	.16.12. C	162	.42.	50500	51500	.42.12. C	425
.17.	50500	51500	.17.12. C	175	.43.	50500	51500	.43.12. C	437
.18.	50500	51500	.18.12. C	187	.45.	50500	51500	.45.12. C	450
.20.	50500/98500	51500/99500	.20.12. C	200	.46.	50500/98500	51500/99500	.46.12. C	462
.21.	50500	51500	.21.12. C	212	.47.	50500	51500	.47.12. C	475
.22.	50500	51500	.22.12. C	225	.48.	50500	51500	.48.12. C	487
.23.	50500	51500	.23.12. C	237	.50.	50500	51500	.50.12. C	500
.25.	50500/98500	51500/99500	.25.12. C	250	.51.	50500	51500	.51.12. C	512
.26.	50500	51500	.26.12. C	262	.52.	50500	51500	.52.12. C	525
.27.	50500	51500	.27.12. C	275	.53.	50500	51500	.53.12. C	537
.28.	50500	51500	.28.12. C	287	.55.	50500	51500	.55.12. C	550
.30.	50500/98500	51500/99500	.30.12. C	300	.60.	50500	51500	.60.12. C	600
.31.	50500	51500	.31.12. C	312					

### Dimensions and order configurations

Part No. structure (pivoting)

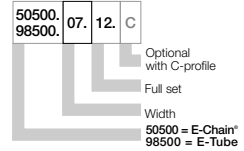

Part No. structure (locking)

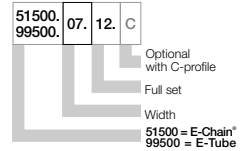

Full set, for both ends:

50500.07.12

Single-part order:

50500.07.1

Mounting bracket with bore

50500.07.2

Mounting bracket with pin

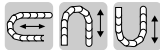

**Option steel - pivoting**

- For pivoting connections
- One part (two-piece) for all chain widths
- Electrically conductive

Moving end  
50500.1

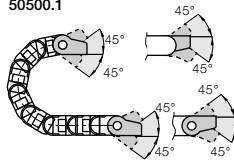

Fixed end  
50500.2

Possible installation conditions -

Further installation angles ► installation sketch

Phone +49- (0) 22 03-96 49-800  
Fax +49- (0) 22 03-96 49-222

igus® GmbH  
51147 Cologne

Internet: [www.igus.de](http://www.igus.de)  
E-mail: [info@igus.de](mailto:info@igus.de)

Moving end  
50500.1

Fixed end  
50500.2

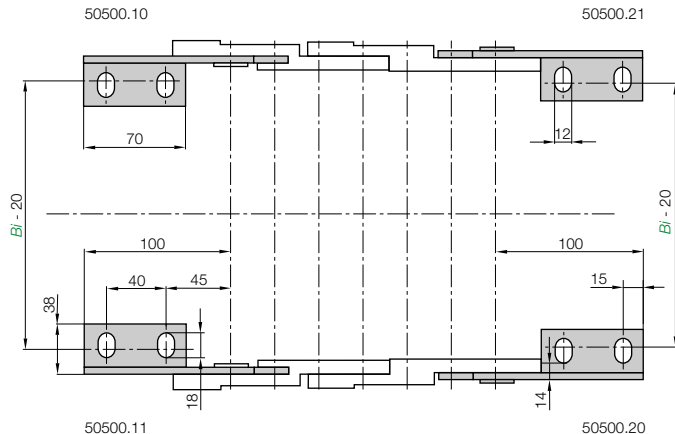

For	Part No.	Bi	For	Part No.	Bi
E-Chain®	full set	[mm]	E-Chain®	full set	[mm]
5050-5150.05	► 50500.12	50	5050-5150.32	► 50500.12	325
5050-5150.06	► 50500.12	65	5050-5150.33	► 50500.12	337
5050-5150-9850.07	► 50500.12	75	5050-5150-9850.35	► 50500.12	350
5050-5150-9850.10	► 50500.12	100	5050-5150.36	► 50500.12	362
5050-5150.11	► 50500.12	112	5050-5150.37	► 50500.12	375
5050-5150-9850.12	► 50500.12	125	5050-5150.38	► 50500.12	387
5050-5150.13	► 50500.12	137	5050-5150-9850.40	► 50500.12	400
5050-5150-9850.15	► 50500.12	150	5050-5150.41	► 50500.12	412
5050-5150.16	► 50500.12	162	5050-5150.42	► 50500.12	425
5050-5150.17	► 50500.12	175	5050-5150.43	► 50500.12	437
5050-5150.18	► 50500.12	187	5050-5150.45	► 50500.12	450
5050-5150-9850.20	► 50500.12	200	5050-5150-9850.46	► 50500.12	462
5050-5150.21	► 50500.12	212	5050-5150.47	► 50500.12	475
5050-5150.22	► 50500.12	225	5050-5150.48	► 50500.12	487
5050-5150.23	► 50500.12	237	5050-5150.50	► 50500.12	500
5050-5150-9850.25	► 50500.12	250	5050-5150.51	► 50500.12	512
5050-5150.26	► 50500.12	262	5050-5150.52	► 50500.12	525
5050-5150.27	► 50500.12	275	5050-5150.53	► 50500.12	537
5050-5150.28	► 50500.12	287	5050-5150.55	► 50500.12	550
5050-5150-9850.30	► 50500.12	300	5050-5150.60	► 50500.12	600
5050-5150.31	► 50500.12	312			

50500.12 Full set, 4 parts

2 with pin / 2 with bore

Single-part order:

50500.1 Mounting bracket

with bore, 1 part left / right

50500.2 Mounting bracket

with pin, 1 part left / right

Other strain relief elements

► chapter 10

Chainfix clamps for the C-profile

Part No. single clamps		Part No. double clamps		Part No. triple clamps		Cable
steel	stainless steel	steel	stainless steel	steel	stainless steel	ø [mm]
CFX12.1	CFX12.1.E	CFX12.2	CFX12.2.E	CFX12.3	-	06 - 12
CFX14.1	CFX14.1.E	CFX14.2	CFX14.2.E	CFX14.3	-	12 - 14
CFX16.1	CFX16.1.E	CFX16.2	CFX16.2.E	CFX16.3	-	14 - 16
CFX18.1	CFX18.1.E	CFX18.2	CFX18.2.E	CFX18.3	-	16 - 18
CFX20.1	CFX20.1.E	CFX20.2	CFX20.2.E	CFX20.3	-	18 - 20
CFX22.1	CFX22.1.E	CFX22.2	CFX22.2.E	CFX22.3	-	20 - 22
CFX26.1	CFX26.1.E	CFX26.2	CFX26.2.E	-	-	22 - 26
CFX30.1	CFX30.1.E	CFX30.2	CFX30.2.E	-	-	26 - 30
CFX34.1	CFX34.1.E	CFX34.2	CFX34.2.E	-	-	30 - 34
CFX38.1	CFX38.1.E	-	-	-	-	34 - 38
CFX42.1	CFX42.1.E	-	-	-	-	38 - 42



igus® Chainfix steel clamps and Chainfix stainless-steel clamps - max. pull forces, adjustable with hexagon socket. Available as single, double or triple clamps. **Details ▶ chapter 10**

System E4/4  
Inner height: 80 mm

Cable ø [mm]	Part No. clamp	Part No. bottom part
04 - 08	CFC-08-M	CFC-08-C
08 - 12	CFC-12-M	CFC-12-C
12 - 16	CFC-16-M	CFC-16-C
16 - 20	CFC-20-M	CFC-20-C
20 - 24	CFC-24-M	CFC-24-C

Chainfix Clip - Modular snap-on strain relief device for C-profile

Available for all igus® E-ChainSystems® with C-profiles and also suitable for assembly in the KMA mounting brackets and clip-on strain relief for crossbars. High pull forces, plug-in modular snap-on strain relief device. **Details ▶ chapter 10**



Part No.	ø max. conduit [mm]	Width [mm]
CFN.20	20	10,8

Chainfix Nugget for the C-Profile

Strain relief for the fixation of cables up to a diameter of Ø 20 mm. Easy to assemble, without any screws and tools. Easy strain relief due to fixation with pre-harnessed cable strap, very small space requirement. **Details ▶ chapter 10**



Part No.	Width of strain relief [mm]	Number of teeth
3050.ZC	50	5
3075.ZC	75	7

Chainfix tiwrap plates with clip-on connection for the C-profile

Can be plugged into the KMA C-profile. Easy to assemble without any screws. Easily solvable with screwdriver nevertheless safe stop. For all E-Chains® with KMA and integrated C-profile. **Details ▶ chapter 10**

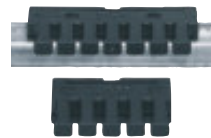

Tiewrap plate	No. of teeth n	Dim. C [mm]	Dim. B [mm]	Center bore
3050.ZB	5	50	30	-
3075.ZB	7	75	55	-
3100.ZB	10	100	80	-
3115.ZB	11	115	95	-
3125.ZB	12	125	105	-
3150.ZB	15	150	130	-
3175.ZB	17	175	155	-
3200.ZB	20	200	180	+
3225.ZB	22	225	205	+
3250.ZB	25	250	230	+

(- = no / + = yes)

Tiewrap plate as individual part

As individual component screwed on KMA. Can be plugged in the mounting brackets. **Details ▶ chapter 10**

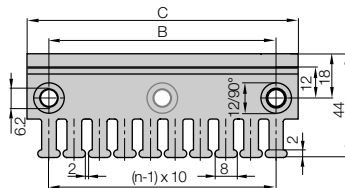

Single tiewrap plate

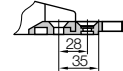

Shown assembled

Phone +49- (0) 22 03-96 49-800  
Fax +49- (0) 22 03-96 49-222



▶ page 7.91

- $B_a$  = Outer width E-Chains® / E-Tube
- $B_i$  = Inner width E-Chains® / E-Tube
- $h_a$  = Outer height E-Chains® / E-Tube
- $H_{Ri}$  = Inner trough height
- $H_{Ra}$  = Outer trough height
- $B_{Ri}$  = Inner trough width ► depends on dim.  $B_a$
- $B_{Ra}$  = Outer trough width
- $n_{Mon}$  = Number of installation sets (left/right)
- $n_{Ri}$  = Number of troughs sets (left/right)
- $H_{Ri} \geq 2 \cdot h_a$
- $B_{Ri} \geq B_a + 4$
- = Guide trough set      ● = Glide bar
- = Installation set "Basic"      ● = C-profile

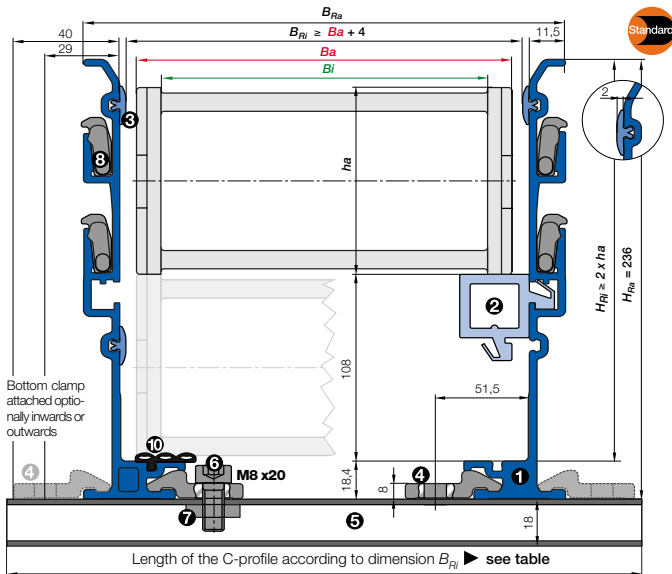

### Installation set "Basic" with C-profile

Bottom Clamp attached optionally inwards or outwards

5050.30.300.0 ► Order example

Part No.	Part No. attached	
	$B_{Ri}$ [mm] inwards	outwards
.05	104	960.50.225
.06	119	960.50.250
.07	129	960.50.250
.10	154	960.50.225
.11	167	960.50.225
.12	179	960.50.250
.13	192	960.50.250
.15	204	960.50.275
.16	217	960.50.275
.17	229	960.50.300
.18	242	960.50.300
.20	254	960.50.325
.21	267	960.50.325
.22	279	960.50.350
.23	292	960.50.350
.25	304	960.50.375
.26	317	960.50.375
.27	329	960.50.400
.28	342	960.50.400
.30	354	960.50.425
.31	367	960.50.425
.32	379	960.50.450
.33	392	960.50.450
.35	404	960.50.475
.36	417	960.50.475
.37	429	960.50.500
.38	442	960.50.500
.40	454	960.50.525
.41	467	960.50.525
.42	479	960.50.550
.43	492	960.50.550
.45	504	960.50.575
.46	517	960.50.575
.47	529	960.50.600
.48	542	960.50.600
.50	554	960.50.625
.51	567	960.50.625
.52	579	960.50.650
.53	592	960.50.650
.55	604	960.50.675
.60	654	960.50.725



- Components, trough "Basic": ① Trough side parts, aluminum, 2 m ② Glide bar, plastic, 2 m ③ Glide strips, plastic, 2 m (without glide strips on request) ⑩ Optional: Silencer profile, rubber
- Components, installation set "Basic": ④ Bottom clamp, aluminum ⑤ C-profile, steel galvanized ⑥ Screw M8 x20 ⑦ Sliding nut M8 ⑧ Interface connector, plastic

### Order example: Length of travel 30 m - Center mounted for Series 5050.30.300.0 with $B_{Ri} = 345$

- Guide trough set (set of 2 trough side parts, incl. glide strips) **without** glide bar  
Order text: 16 m guide trough without glide bar (8 x 2 m sections) **Part No. 975.30.SL**
- Guide trough set (set of 2 trough side parts, incl. glide strips) **with** glide bar  
Order text: 16 m guide trough with glide bar (8 x 2 m sections) **Part No. 975.31.SL**
- Installation set "Basic" complete (guide trough-sets + 1)  
Order text: 17 installation sets "Basic" **Part No. 960.50.425**
- Module for the fixed end  
Order text: 1 set **Part No. 975.80**
- Option: For an additional noise dampening with silencer profile, please add Index A - Example: **Part No. 975.30.SLA**

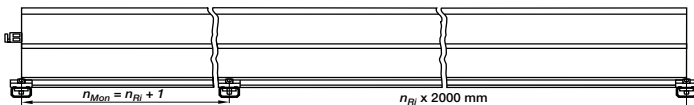

Principle sketch: Number of installation sets to be installed = Number of trough sections + 1



### NEW! A quick fix for mounting the stationary end of an E-Chain®

- With this new module for the fixed end, fast and easy mounting onto the Aluminum "SuperTrough" is now possible without any drilling. Fast mounting of the E-Chain® by clamping onto the aluminum trough
- Quick relocation of the stationary end
- No drilling necessary ► page 9.16

Phone +49- (0) 22 03-96 49-800  
Fax +49- (0) 22 03-96 49-222

igus® GmbH  
51147 Cologne

Internet: www.igus.de  
E-mail: info@igus.de



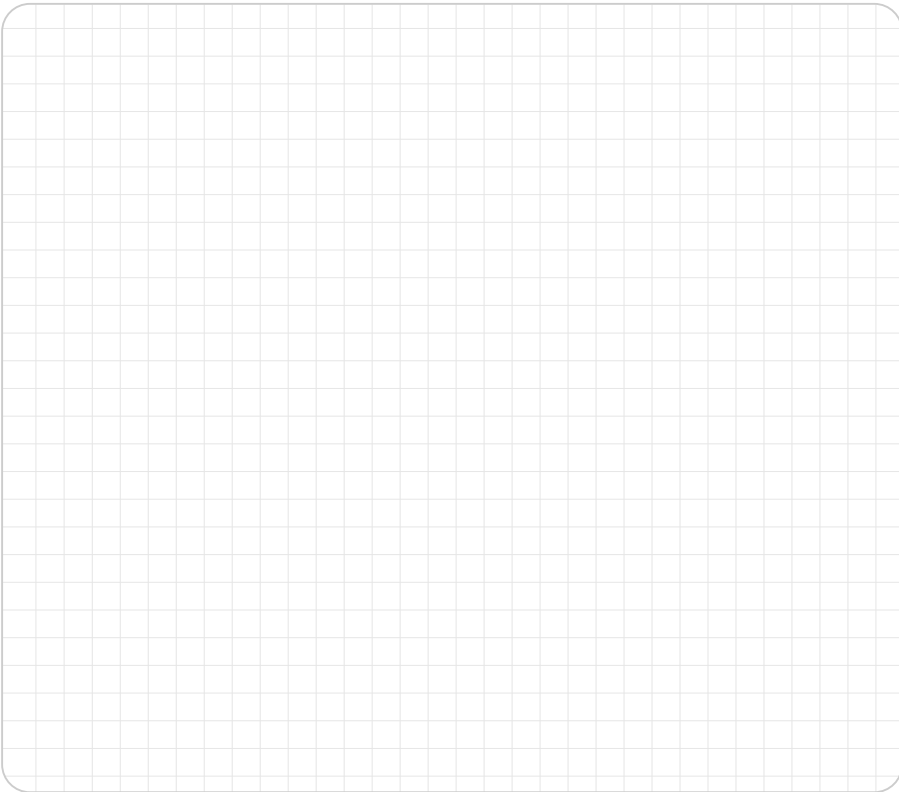

System E4/4  
Inner height: 80 mm

Phone +49- (0) 22 03-96 49-800  
Fax +49- (0) 22 03-96 49-222



▶ Chapter 9



▶ page 7.91



TIP!

# 5050AX and 5050HDAX

## Special E-Chains® for fine dust applications

Long travel of 300 m and more are for instance often found in coal conveyors. For these travel lengths, types of loads and dirt accumulations, we have developed a special E-ChainSystem® with exterior, dirt-repellent stop dogs.

- Exterior stop dogs prevent the settling of dust, dirt, chips, flour, etc.
- Mounting brackets and accessories from the E4/4 series
- Also available as heavy-duty-version - Series 5050HDAX

Series 5050AX - Order example 5050AX.30.250.0 / Series 5050HDAX - Order example 5050AXHD.30.250.0  
Further information: [igus.de/en/5050AX](http://igus.de/en/5050AX) or phone +49-0 22 03-96 49-800

Price index



Series 5050HD Series R9850HD



Side-mounted -  
unsupported



ESD classification:  
Electrically conductive ESD/ATEX  
version upon request



Very high  
torsional rigidity



Opening E-Chains\*: Remove crossbars and clips - Insert screwdriver into the slot, push down, release by lever action



Remove lids/bottoms (E-Tubes) - Insert screwdriver into the slot, release by lever action



When to use the Series 5050HD/R9850HD:

- For high (tensile-)charges at long travel applications
- When high torsional forces are expected
- For long-term operation in very moist environments
- Also available as Rol E-Chain\*



When not to use them:

- At short travels or medium additional loads  
▶ Series 5050/5150/R9850, page 7.136
- If a simple and low-cost solution is required  
▶ Series 15050/15150/R19850, page 7.182

- 1 High side-mount stability due to tongue and groove
- 2 High torsional rigidity
- 3 High tensile stability (20% higher tensile force than Series 5050)
- 4 Very wide gliding surface, less wear
- 5 Closed and open styles can be combined
- 6 Hinged snap-open removable lids along outer radius of E-Tube
- 7 Numerous interior separation possibilities
- 8 Crossbars are removable along both radii
- 9 Wide, rounded plastic crossbars - cable friendly
- 10 Robust Steel-Mounting Brackets



Rol E-Chain\* Series  
5050RHD/9850RHD  
available upon request

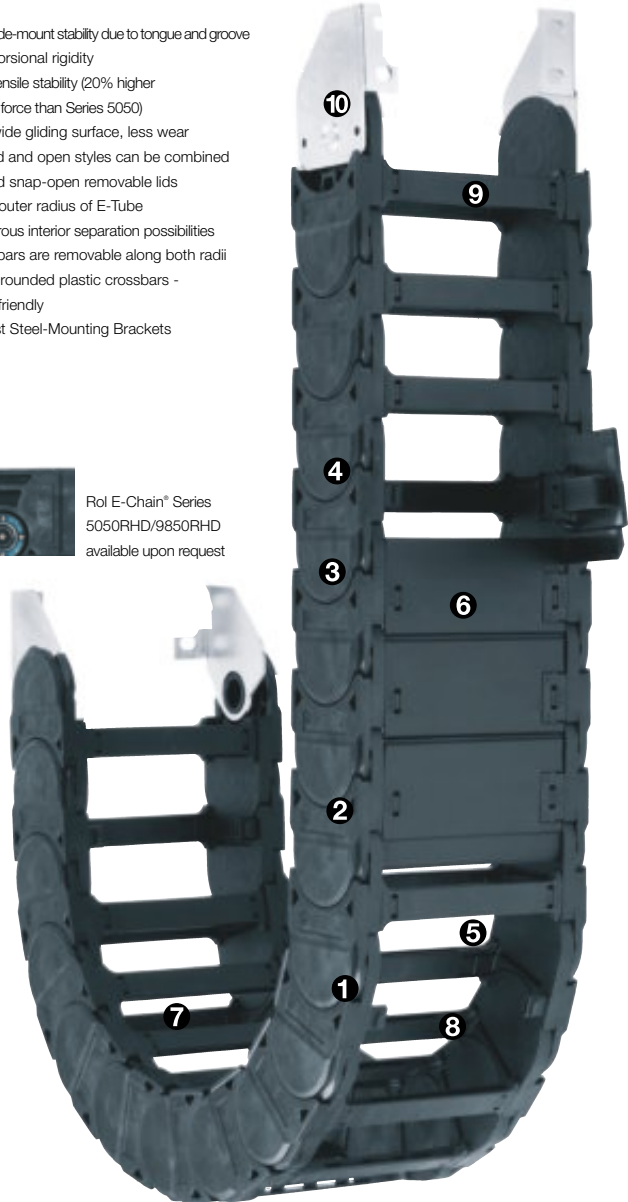

Order example complete E-Chain\*

Please indicate chain-lengths or number of links Example: 5 m or 55 links

5 m 5050HD.30.300.0

E-Chain\*

with 2 separators 511 assembled every 2<sup>nd</sup> link

Interior separation

1 set 5050HD.12.E

Mounting bracket

**Unsupported length**

$FL_G$  = with straight upper run

$FL_B$  = with permitted sag

Further information ► Design, page 1.12

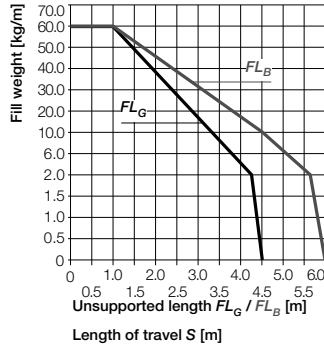
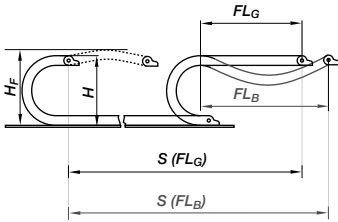

- S = Length of travel
- R = Bending radius
- H = Nominal clearance height
- $H_F$  = Required clearance height
- $H_{in}$  = Trough inner height
- D = Overlength E-Chain\* radius in final position
- $K = \pi \cdot R + \text{"safety"}$
- $D_2$  = Overlength - long travels, gliding
- $K_2$  = \*Further add-on
- $H_2$  = \*Mounting height

\*If the mounting bracket location is set lower

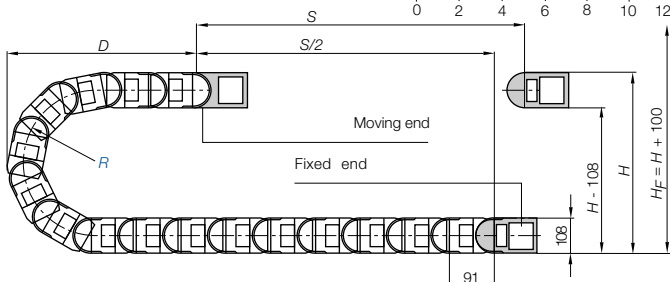

Pitch = 91 mm/Glided    Links/m = 11 (1001 mm)    Chain length =  $S/2 + K$

R	200	300	350	500
H	508	708	808	1108
D	345	445	495	645
K	815	1125	1285	1755
$D_2$	800	1200	1550	2157
$K_2$	1274	2002	2457	3458
$H_2$	242	242	242	242



**Short travels - unsupported**

Unsupported E-Chains\* feature positive camber over short travels. This must be accounted for when specifying the clearance height  $H_F$ . Please consult igus\* if space is particularly restricted.

The required clearance height:  
 $H_F = H + 100$  mm  
(with 3,0 kg/m fill weight)

**Long travel lengths from 10 m to max. 500 m    Chain length =  $S/2 + K_2$**

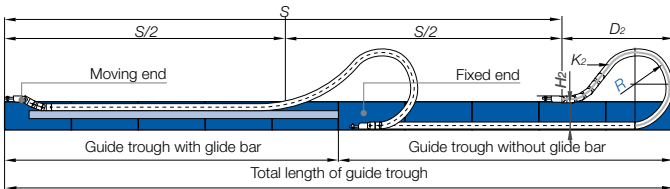

In case of travels between 4 and 10 m we recommend a longer unsupported length.



**Gliding, long travel applications (max. 500 m)**

In this case the E-Chain\* upper run will be introduced in a guide trough on the lower run. We recommend to realize the engineering of such a plant by our technicians.

Speed / acceleration $FL_G$	max. 20 [m/s] / max. 200 [m/s <sup>2</sup> ]
Speed / acceleration $FL_B$	max. 3 [m/s] / max. 6 [m/s <sup>2</sup> ]
Gliding speed / acceleration (maximum)	max. 10 [m/s] / max. 50 [m/s <sup>2</sup> ]
Material - permitted temperature °C	igumid G / -40° up to +120° C
Flammability class, igumid G	VDE 0304 IIC UL94 HB

**Technical Data**



Details of material properties  
► page 1.38

80

System E4/4  
Inner height: 80 mm

Phone +49- (0) 22 03-96 49-800  
Fax +49- (0) 22 03-96 49-222



► page 7.91

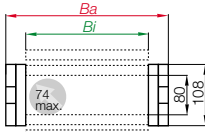

Part No. structure

5050HD. 30. 300. 0



Serie 5050HD - E-Chain® with crossbars every link

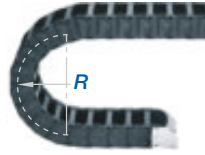

- Crossbars every link
- For highest additional loads
- For applications particularly demanding
- Can be opened from two sides

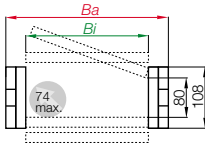

Part No. structure

9850HD. 30. 300. 0



Serie R9850HD - Fully enclosed E-Tube

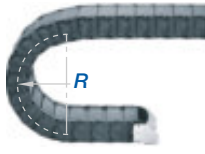

- Fully enclosed
- Excellent cable protection against dirt
- Protection against hot chips
- Lids along the entire inner radius are completely removable. Lids along the entire outer radius are single sided snap-open with a hinge on the other side to keep them attached to the chain or completely removable



igus® E-Chains® 5050RHD "Rol E-Chain™" in an igus® super-allow-trough = 75% less driving power



Rol instead of gliding: Rol E-Chain®

Special solution for long travels. 75% less drive power (gliding application) with igus® Rol E-Chain®, Series 5050RHD and 9850RHD - Order example 5050RHD.30.300.0

Further information: [www.igus.de/en/role](http://www.igus.de/en/role) or phone: +49-0 22 03-96 49-800



TIP!

Part No.		<i>Bi</i>	<i>Ba</i>	5050HD	R9850HD
		[mm]	[mm]	[kg/m]	[kg/m]
5050HD.05.	<input type="checkbox"/> .0	50	110	≈ 6,65	-
5050HD.06.	<input type="checkbox"/> .0	65	125	≈ 6,74	-
5050HD/9850HD.	<input type="checkbox"/> .0*	75	135	≈ 6,81	≈ 7,25
5050HD/9850HD.10.	<input type="checkbox"/> .0	100	160	≈ 6,99	≈ 7,55
5050HD.11.	<input type="checkbox"/> .0	112	172	≈ 7,10	-
5050HD/9850HD.12.	<input type="checkbox"/> .0	125	185	≈ 7,18	≈ 7,91
5050HD.13.	<input type="checkbox"/> .0	137	197	≈ 7,32	-
5050HD/9850HD.15.	<input type="checkbox"/> .0	150	210	≈ 7,35	≈ 8,29
5050HD.16.	<input type="checkbox"/> .0	162	222	≈ 7,47	-
5050HD.17.	<input type="checkbox"/> .0	175	235	≈ 7,60	-
5050HD.18.	<input type="checkbox"/> .0	187	247	≈ 7,71	-
5050HD/9850HD.20.	<input type="checkbox"/> .0	200	260	≈ 7,77	≈ 8,91
5050HD.21.	<input type="checkbox"/> .0	212	272	≈ 7,84	-
5050HD.22.	<input type="checkbox"/> .0	225	285	≈ 7,91	-
5050HD.23.	<input type="checkbox"/> .0	237	297	≈ 8,02	-
5050HD/9850HD.25.	<input type="checkbox"/> .0	250	310	≈ 8,13	≈ 9,64
5050HD.26.	<input type="checkbox"/> .0	262	322	≈ 8,22	-
5050HD/9850HD.27.	<input type="checkbox"/> .0	275	335	≈ 8,32	≈ 10,00
5050HD.28.	<input type="checkbox"/> .0	287	347	≈ 8,38	-
5050HD/9850HD.30.	<input type="checkbox"/> .0	300	360	≈ 8,53	≈ 10,30
5050HD.31.	<input type="checkbox"/> .0	312	372	≈ 8,57	-
5050HD.32.	<input type="checkbox"/> .0	325	385	≈ 8,67	-
5050HD.33.	<input type="checkbox"/> .0	337	397	≈ 8,79	-
5050HD/9850HD.35.	<input type="checkbox"/> .0	350	410	≈ 8,99	≈ 11,00
5050HD.36.	<input type="checkbox"/> .0	362	422	≈ 8,90	-
5050HD.37.	<input type="checkbox"/> .0	375	435	≈ 9,00	-
5050HD.38.	<input type="checkbox"/> .0	387	447	≈ 9,11	-
5050HD/9850HD.40.	<input type="checkbox"/> .0	400	460	≈ 9,38	≈ 12,00
5050HD.41.	<input type="checkbox"/> .0	412	472	≈ 9,31	-
5050HD.42.	<input type="checkbox"/> .0	425	485	≈ 9,60	-
5050HD.43.	<input type="checkbox"/> .0	437	497	≈ 9,44	-
5050HD.45.	<input type="checkbox"/> .0	450	510	≈ 9,55	-
5050HD/9850HD.46.	<input type="checkbox"/> .0	462	522	≈ 9,72	≈ 12,47
5050HD.47.	<input type="checkbox"/> .0	475	535	≈ 9,76	-
5050HD.48.	<input type="checkbox"/> .0	487	547	≈ 10,01	-
5050HD.50.	<input type="checkbox"/> .0	500	560	≈ 10,11	-
5050HD.51.	<input type="checkbox"/> .0	512	572	≈ 10,02	-
5050HD.52.	<input type="checkbox"/> .0	525	585	≈ 10,19	-
5050HD.53.	<input type="checkbox"/> .0	537	597	≈ 10,29	-
5050HD.55.	<input type="checkbox"/> .0	550	610	≈ 10,71	-
5050HD.60.	<input type="checkbox"/> .0	600	660	≈ 10,94	-

Available bending radii

R [mm] 200 300 350 500

Supplement Part No. with required radius. Example: 5050HD.30.300.0

0 = standard color, other colors ▶ page 1.39 - Pitch = 91 mm/link - Links/m = 11

\*not available for R9850HD

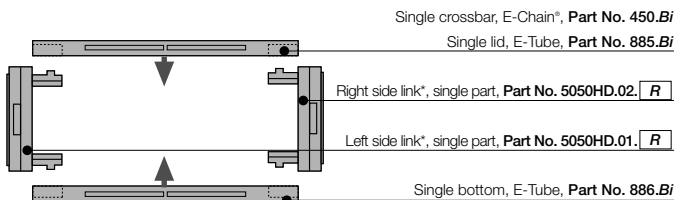

**TIP!**

## Hot Chips up to 850°C

E-Tubes that repel hot chips, up to 850 °C  
Some applications, depending on amount and size of the chips, can burn or melt the surface. That is no longer the case with the new igus® "Iguimid HT" material.

Further information:  
www.igus.de/en/HT  
or phone:  
+49-0 22 03-96 49-800

System E4/4  
Inner height: 80 mm

Phone +49- (0) 22 03-96 49-800  
Fax +49- (0) 22 03-96 49-222



▶ page 7.91



Extender crossbar for large diameter hoses ▶ page 7.142

### Part No. E-Chain® - links, single parts

\*View from the fixed point of the E-Chain®/E-Tube



**Option 1**

- Vertical separators
- Spacers
- Locking separators
- Asymmetric separators

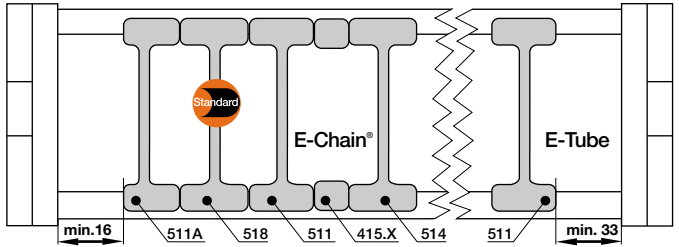

Vertical separator  
501



Spacer  
405.10



Spacer  
405.15



Spacer  
405.20



Spacer  
405.30



Spacer  
405.40



Locking separator  
504



Locking separator  
508



Asymmetric  
separator 501A

<b>Vertical separator for E-Chains®/E-Tubes</b>	
unassembled	501
assembled	511



<b>Spacer* for E-Chains®</b>	
unassembled	405.10
assembled	415.10



<b>Spacer* for E-Chains®</b>	
unassembled	405.15
assembled	415.15



<b>Spacer* for E-Chains®</b>	
unassembled	405.20
assembled	415.20



<b>Spacer* for E-Chains®</b>	
unassembled	405.30
assembled	415.30



<b>Spacer* for E-Chains®</b>	
unassembled	405.40
assembled	415.40



<b>Locking separator for E-Chains®</b>	
unassembled	504
assembled	514



<b>Locking separator for E-Chains®</b>	
unassembled	508
assembled	518



<b>Asymmetric separator for E-Chains®</b>	
unassembled	501A
assembled	511A



\*For side-mounted applications

**Option 1: Vertical separators and spacers**

Vertical separators are used if a vertical subdivision of the E-Chain® interior is required - By standard vertical separators are assembled every other E-Chain® link. **Note:** Observe a lateral spacing of at least 16 mm! Exception: No minimum spacing is needed for side plates

● **Standard separator 501 for E-Chains® and E-Tubes** offers safe stability due to its wide base design, also when used with thick cables or hoses

● Vertical separators in side-mounted applications, for instance, can be fixed in position by means of **spacer 405.X for E-Chains®**. A wide range of intervals between the vertical separators is adjustable here

● **Note on spacers:** The available interior height is reduced by 2 mm per spacer (4 mm when spacers are fitted on both sides)

**Additionally:**

● **Locking separator for E-Chains® 504-** with increased retention force for applications exposed to very high humidity or extreme loads. If locking separators are used, the E-Chain® is more difficult to open

● The **Locking separator for E-Chains® 508** is designed for applications exposed to extremely high humidity, for example, at composting plants. The lateral cam serves for uniform alignment of the vertical separators; if these separators are misaligned, they will inevitably get damaged on an attempt to open the E-Chain®.

● **Asymmetric separator 501A for E-Chains®** (not for E-Tubes) with an 18-mm base, for combinations between spacers of different widths and vertical separators in side-mounted applications, for instance.

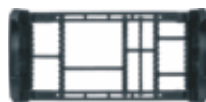
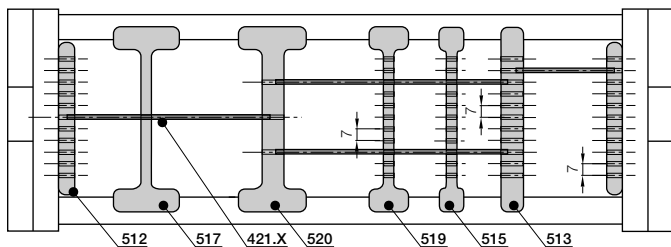

**Option 2**

- Side plates
- Middle plates
- Locking vertical separator
- Locking separators
- Slotted separators
- Open slotted separators

**Option 2: Shelves**

For applications involving many cables with different diameters. The shelves can be arranged elevator-shifted with different bottoms.

● Side plates 502, middle plates 503 and shelves 420.X form the basic pattern of a shelf system. Shelves of various widths can be arranged at 11 different heights (in 7 mm increments).

● Locking vertical separator 510 combined with shelves. Triple slots.

● Locking separator 507 slotted - with increased retention force for applications exposed to very high humidity or extreme loads. The extra retention force is achieved by asymmetric claws for the crossbar. Ensure proper alignment.

● Slotted separators 505 are used for very fine subdivisions. However, they cannot be retrofitted into an existing separation system without dismantling the interior separators first.

● The unilateral open slotted separator 509 can be retrofitted into an existing interior separation system without a need for dismantling the interior separators. During an installation of open slotted separators, the top and bottom notches cannot be occupied by shelves.

**Side plate for E-Chains®/E-Tubes**

unassembled	502
assembled	512

**Middle plate for E-Chains®/E-Tubes**

unassembled	503
assembled	513

**Locking vertical separator for E-Chains®/E-Tubes**

unassembled	510
assembled	520

**Locking separator for E-Chains®**

unassembled	507
assembled	517

**Slotted separator for E-Chains®/E-Tubes**

unassembled	505
assembled	515

**Open slotted separator for E-Chains®/E-Tubes**

unassembled	509
assembled	519

Width X [mm]	Part No. unassembled	Part No. assembled
18	420.18	421.18
23	420.23	421.23
25	420.25	421.25
28	420.28	421.28
33	420.33	421.33
43	420.43	421.43
50	420.50	421.50
62	420.62	421.62

Width X [mm]	Part No. unassembled	Part No. assembled
75	420.75	421.75
100	420.100	421.100
125	420.125	421.125
150	420.150	421.150
175	420.175	421.175
187	420.187	421.187
200	420.200	421.200

**Side plate 502**

**Middle plate 503**

**Locking vertical separator 510**

**Locking separator slotted 507**

**Slotted separator 505**

**Open slotted separator 509**

**Shelf 420.X**

**Additional elements for interior separation**

**Rollclip**

unassembled	489.27
assembled	490.27

**Rollclip** - minimizes abrasion of particularly sensitive hoses. The Rollclip is simply clamped onto the opening crossbar. The movable rollers compensate for relative movement between the chain and hose.



System E4/4  
Inner height: 80 mm

Phone +49- (0) 22 03-96 49-800  
Fax +49- (0) 22 03-96 49-222



▶ page 7.91



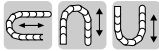

**Option steel - pivoting**

- For pivoting connections
- One part (two-piece) for all chain widths
- Electrically conductive

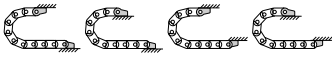

Possible installation conditions -  
Further installation angles ► installation sketch

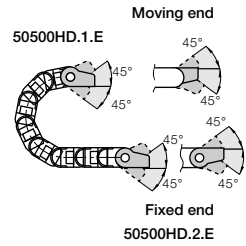

Phone +49- (0) 22 03-96 49-800  
Fax +49- (0) 22 03-96 49-222

igus® GmbH  
51147 Cologne

Moving end  
50500HD.1.E

Fixed end  
50500HD.2.E

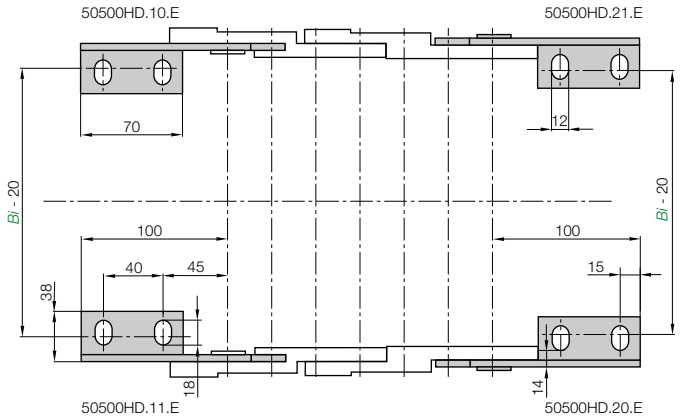

50500HD. 12 .E Full set, 4 parts  
2 with pin / 2 with bore

Single-part order:

50500HD. 1 .E Mounting bracket  
with bore, 1 part left / right

50500HD. 2 .E Mounting bracket  
with pin, 1 part left / right

Part No.	Mounting bracket
50500HD. 12 .E	Full set, 4 parts, 2 with pin / 2 with bore
50500HD. 1 .E	Mounting bracket with bore, 1 part left / right
50500HD. 2 .E	Mounting bracket with pin, 1 part left / right

E4/4 | Series 5050HD-R9850HD | Accessories | Strain Relief

**Tiewrap plate as individual part**

As individual component screwed on KMA. Can be plugged in the mounting brackets. **Details ► chapter 10**

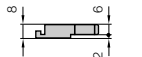
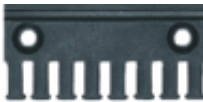

Single tiewrap plate

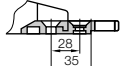

Shown assembled

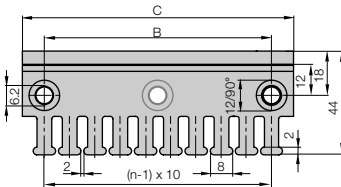

Tiewrap plate	No. of teeth n	Dim. C [mm]	Dim. B [mm]	Center bore
3050.ZB	5	50	30	-
3075.ZB	7	75	55	-
3100.ZB	10	100	80	-
3115.ZB	11	115	95	-
3125.ZB	12	125	105	-
3150.ZB	15	150	130	-
3175.ZB	17	175	155	-
3200.ZB	20	200	180	+
3225.ZB	22	225	205	+
3250.ZB	25	250	230	+

(- = no / + = yes)

Internet: [www.igus.de](http://www.igus.de)  
E-mail: [info@igus.de](mailto:info@igus.de)

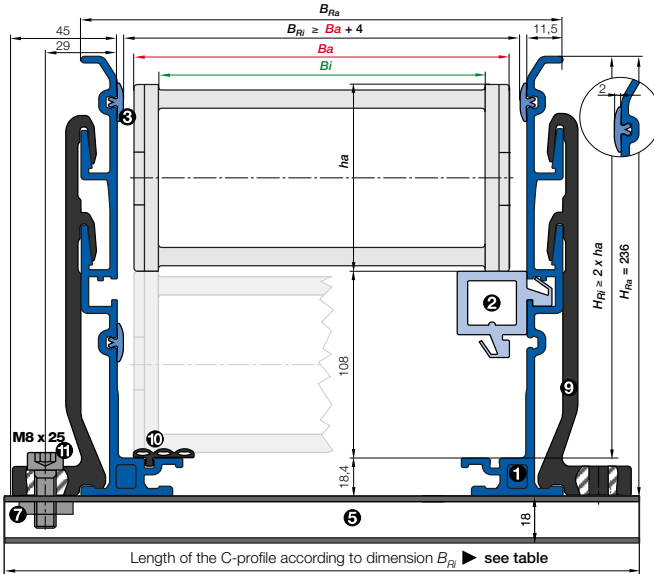

- $B_a$  = Outer width E-Chains® / E-Tube
- $B_i$  = Inner width E-Chains® / E-Tube
- $h_a$  = Outer height E-Chains® / E-Tube
- $H_{Ri}$  = Inner trough height
- $H_{Ra}$  = Outer trough height
- $B_{Ri}$  = Inner trough width ► depends on dim.  $B_a$
- $B_{Ra}$  = Outer trough width
- $n_{Mon}$  = Number of installation sets (left/right)
- $n_{Ri}$  = Number of trough sets (left/right)
- $H_{Ri} \geq 2 \cdot h_a$
- $B_{Ri} \geq B_a + 4$
- = Guide trough set      ● = Glide bar
- = Installation set "Basic"      ● = C-profile

**Installation set Heavy-Duty with C-profile**

5050HD.30.300.0 ► Order example

$B_{Ri}$ [mm]	Part No. assembled
.05	114 974.50.250
.06	129 974.50.250
.07	139 974.50.275
.10	164 974.50.300
.11	176 974.50.300
.12	189 974.50.325
.13	201 97450.325
.15	214 97450.350
.16	226 974.50.350
.17	239 97450.375
.18	251 974.50.375
.20	264 974.50.400
.21	276 974.50.400
.22	289 974.50.425
.23	301 974.50.425
.25	314 974.50.450
.26	326 974.50.450
.27	339 974.50.475
.28	351 974.50.475
.30	364 974.50.500
.31	376 974.50.500
.32	389 974.50.525
.33	401 974.50.525
.35	414 974.50.550
.36	426 974.50.550
.37	439 974.50.575
.38	451 974.50.575
.40	464 974.50.600
.41	476 974.50.600
.42	489 974.50.625
.43	501 974.50.625
.45	514 974.50.650
.46	526 974.50.650
.47	539 974.50.675
.48	551 974.50.675
.50	564 974.50.700
.51	576 974.50.700
.52	589 974.50.725
.53	601 974.50.725
.55	614 974.50.750
.60	664 974.50.800



- **Components, trough "Heavy Duty":** ① Trough side parts, aluminum, 2 m ② Glide bar, plastic, 2 m ③ Glide strips, plastic, 2 m (without glide strips on request) ⑩ Optional: Silencer profile, rubber
- **Components, installation set "Heavy Duty":** ⑤ C-profile, steel galvanized ⑦ Sliding nut M6 ⑨ Installation angle bracket "Heavy Duty", Aluminium ⑪ Screw M6 x 20



**Order example: Length of travel 30 m - Center mounted for Series 5050HD.30.300.0 with  $B_{Ri} = 364$**

Guide trough set (set of 2 trough side parts, incl. glide strips) <b>without</b> glide bar	Part No.	975.30.SL
Order text: 16 m guide trough without glide bar (8 x 2 m sections)		
Guide trough set (set of 2 trough side parts, incl. glide strips) <b>with</b> glide bar	Part No.	975.31.SL
Order text: 16 m guide trough with glide bar (8 x 2 m sections)		
Installation set "Basic" complete (guide trough-sets + 1)	Part No.	974.50.500
Order text: 17 installation sets "Basic"		
Module for the fixed end	Part No.	975.80
Order text: 1 set		
Option: For an additional noise dampening with silencer profile, please add Index A - Example:	Part No.	975.30.SLA

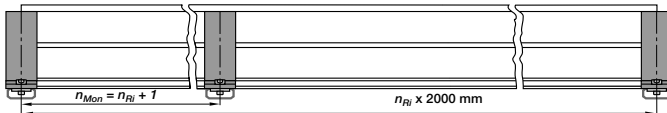

Principle sketch: Number of installation sets to be installed = Number of trough sections + 1

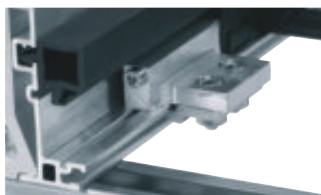

**NEW! A quick fix for mounting the stationary end of an E-Chain®**

With this new module for the fixed end, fast and easy mounting onto the Aluminum "SuperTrough" is now possible without any drilling. Fast mounting of the E-Chain® with any opening of the Aluminum trough

- Quick relocation of the stationary end
- No drilling necessary ► page 9.16

Phone +49- (0) 22 03-96 49-800  
 Fax +49- (0) 22 03-96 49-222

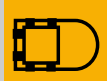

► Chapter 10



► Chapter 9



► page 7.91





**hooks.**

**claws.**

**E4/light**

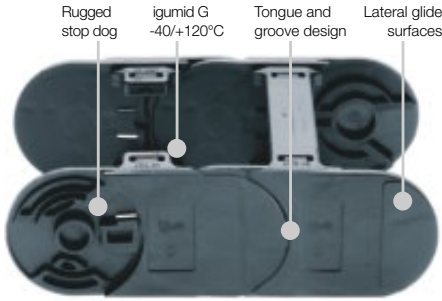

## New E4/light version with the special "tongue-and-groove-design" from the proven E4/4 Series

- Low weight
- Optimized ratio of interior and exterior dimension
- Cost-effective
- Numerous interior separation possibilities
- Broad system of modular accessories
- Narrow outer links
- Max. travel: 150 - 250 m
- You can find more technical data about the material, chemical resistance, temperatures ► **Design, from page 1.38**

### Opening-principle

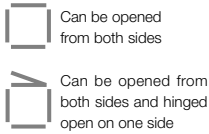

### Dimensioning

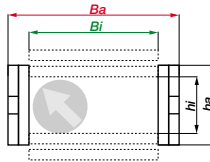

### Bending radius

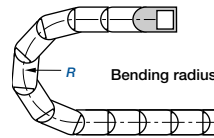

### Part No. structure

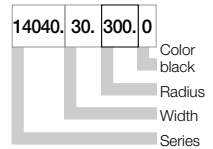

### Selection table

Series	Inner height <i>hi</i> [mm]	Inner width <i>Bi</i> [mm]	Outer width <i>Ba</i> [mm]	Outer height <i>ha</i> [mm]	Bending radius <i>R</i> [mm]	Unsupported length max. [m]	page
<b>Crossbars every link - for particular demanding applications</b>							
14040	56	50 - 600	76 - 626	84	135 - 500	4,0	7.162
14240	62	50 - 400	76 - 426	84	135 - 500	4,0	7.172
15050	80	50 - 600	80 - 630	108	150 - 500	4,5	7.182
1640	112	50 - 600	84 - 634	140	200 - 600	4,5	7.194
<b>Crossbars every other link - for almost all applications</b>							
14140	56	50 - 600	76 - 626	84	135 - 500	4,0	7.162
14340	62	50 - 400	76 - 426	84	135 - 500	4,0	7.172
15150	80	50 - 600	80 - 630	108	150 - 500	4,5	7.182
<b>E-Tube - fully enclosed, excellent cable protection</b>							
R18840	56	75 - 462	101 - 489	84	150 - 500	4,0	7.162
R19850	80	75 - 462	105 - 493	108	200 - 500	4,5	7.182
R1608	112	200 - 400	234 - 434	140	250 - 600	4,5	7.194

Comparison of the main characteristics

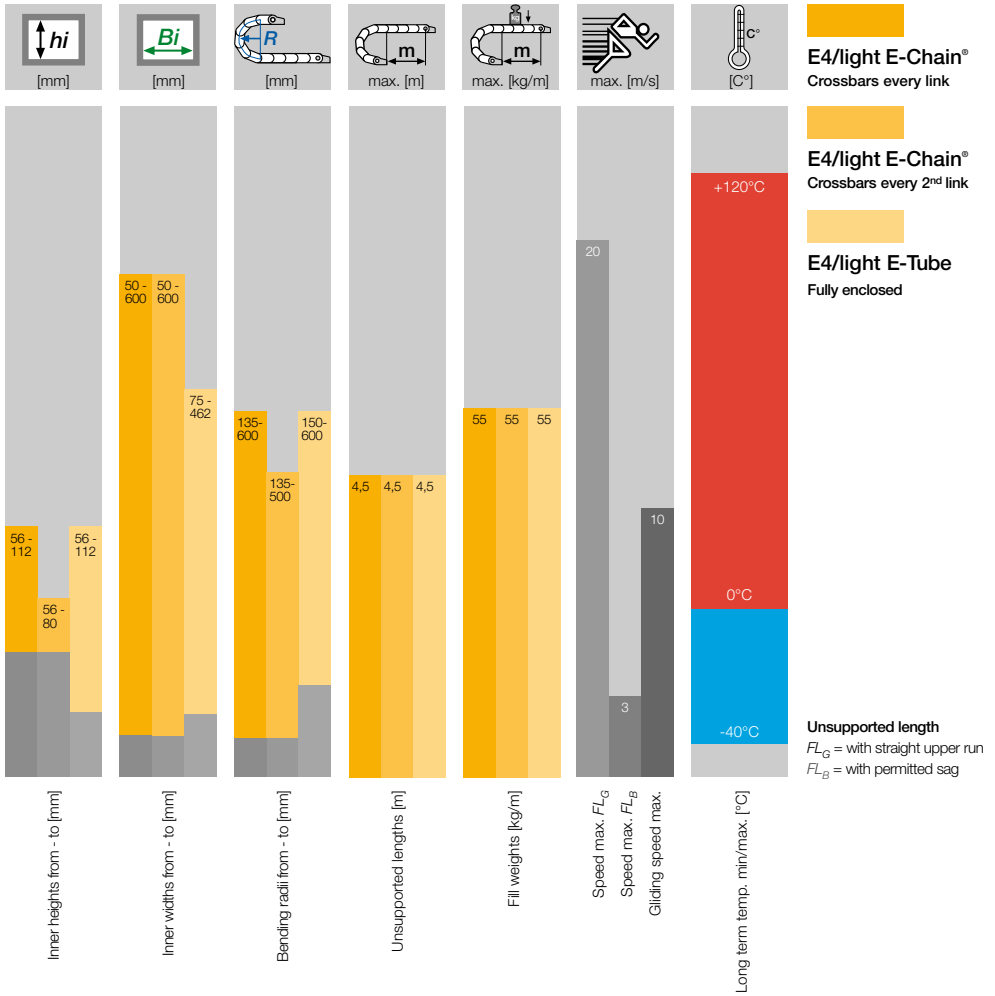

Additional quality features - System E4/light



ESD classification: Electrically conductive  
ESD/ATEX version upon request



System E4/light proved with long travels



Side-mounted - unsupported



System E4 - 4-piece design link



High torsional rigidity

**E4/light** - The "light" features appear in two places: **A reduced thickness of the side links** (for all types), and **a thinner crossbar** (for some types: 142, 143, 1640). **Weight reduction**, a **large interior space** and **price reduction** result as well as a compromise in strength. E4/light E-Chains® achieve optimum price-performance solutions for many industries. Especially for unsupported short travels, hanging and short standing designs. E4/light types are often first choice.

### Typical industries & applications

- Machine tools (closed E4/light tubes and open E-Chains®)
- Material handling
- Stone cutting machines
- Woodworking machines
- General machinery
- Vehicles
- Construction machinery
- Limited long travel applications



E4/light - now stronger with the "tongue-and-groove-design"



E4/light is popular for hanging applications

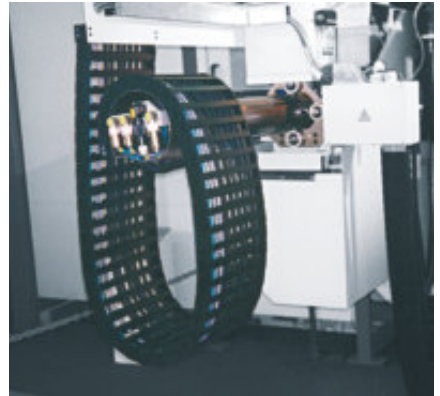

Circular motions possible (also with "RBR" - reverse bending radius)



E4/light is ideal in Machine Tools with their typical short strokes



System E4 E-Chain® - carries conduits up to 100 mm diameter



System E4/light | E-Chains® and E-Tubes | **Assembling**



1 Position at one side...



2 ...and snap in

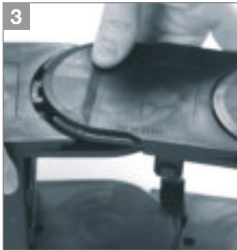

3 Position opposite side, press together and snap in



4 Assemble crossbars - Push down and snap in by using a screwdriver

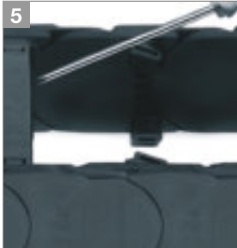

5 Assemble clips (E-Chains®) with crossbars every other link - Push down and snap in



6 Assemble E-Tube lids/bottoms - Attach to the connector at an angle - Snap in

System E4/light | E-Chains® and E-Tubes | **Separating**



1 Remove crossbars, clips, and lids on two adjacent chain links. Guide the screwdriver into the slot between side links and release it by levering it and separate the E-Chain®



E-Chains® | **Opening**



1 Remove crossbars - Insert screwdriver into the slot, push down, release by lever action

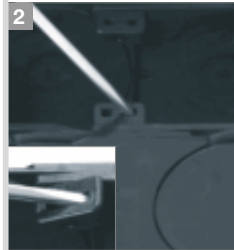

2 Remove clips - Insert screwdriver into the slot and push down, release by lever action

E-Tubes | **Opening**



1 Remove lids/bottoms - Insert screwdriver into the slot, release by lever action

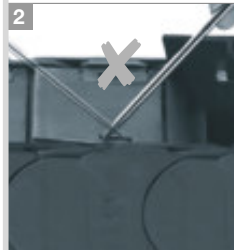

2 Release only one side to swivel the lid



You can find an assembly video on the web ► [www.igus.de/en/e4\\_assembly](http://www.igus.de/en/e4_assembly)

Price index



**ESD classification:**  
Electrically conductive ESD/ATEX  
version upon request



**High torsional  
rigidity**



**Side-mounted -  
unsupported**



**Opening E-Chains®:** Remove crossbars and clips - Insert screwdriver into the slot, push down, release by lever action



**Remove lids/bottoms (E-Tubes) -** Insert screwdriver into the slot, release by lever action



**When to use the Series 14040/14140/R18840:**

- For achieving simple, economical solutions
- For minimizing a chain's external width at any given internal width
- For use if Series 400 proves too large



**When not to use it:**

- If a quieter version is required  
▶ Series 400/410/R880, page 7.48
- If long side-mounted, unsupported length is required  
▶ Series 4040/4140/R8840, page 7.116

- ❶ Crossbars on E-Chains® are removable along both radii
- ❷ Hinged snap-open removable lids along outer radius of E- Tube
- ❸ Closed and open styles can be combined
- ❹ Lateral glide surfaces for side-mounted operation
- ❺ Wide, rounded plastic crossbars - cable friendly
- ❻ Removable lids along inner radius
- ❼ Locking or pivoting mounting brackets available
- ❽ KMA mounting brackets with attachment points on all sides
- ❾ Integrated strain relief possible
- ❿ New stronger version with "tongue-and-groove-design"
- ⓫ E-Chains® also available with reverse bending radius "RBR"



**Order example complete E-Chain®**

Please indicate chain-lengths or number of links **Example:** 5 m or 55 links

5 m 14040.30.300.0

E-Chain®

with 2 separators 411 assembled every 2<sup>nd</sup> link

Interior separation

1 set 141400.30.12.C

Mounting bracket

**Unsupported length**

$FL_G$  = with straight upper run  
 $FL_B$  = with permitted sag  
 Further information ► **Design, page 1.12**

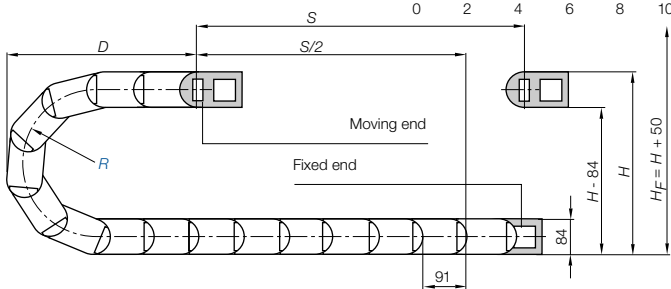
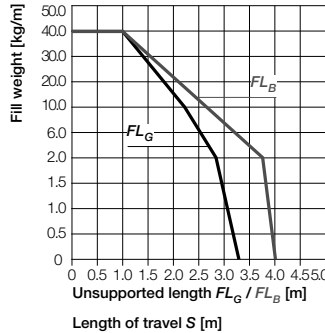
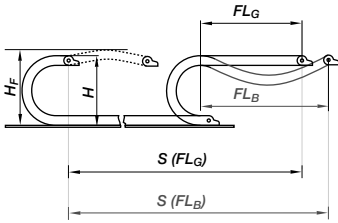

Pitch = 91 mm/link    Links/m = 11 (1001 mm)    Chain length =  $S/2 + K$

R	135	150	175	200	250	300	400	500
$H_{25}^0$	360	385	435	485	585	685	885	1085
D	270	285	310	335	385	435	535	635
K	650	750	825	900	1050	1225	1450	1775
$D_2^{+25}$	390	450	550	710	920	1120	1530	1850
$K_2$	728	819	1001	1274	1638	1911	2548	3185
$H_2$	266	266	266	266	266	266	266	266

- S = Length of travel
- R = Bending radius
- H = Nominal clearance height
- $H_F$  = Required clearance height
- $H_{in}$  = Trough inner height
- D = Overlength E-Chain® radius in final position
- $K = \pi \cdot R + \text{"safety"}$
- $D_2$  = Over length - long travels, gliding
- $K_2$  = "Further add-on"
- $H_2$  = "Mounting height"
- \*if the mounting bracket location is set lower

**Other installation methods**

- Vertical, hanging  $\leq 80$  m
- Vertical, standing  $\leq 6$  m
- Side mounted, un supp.  $\leq 2$  m
- Rotary requires further calculation
- Unsupported length of upper run = upon request

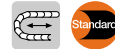

**Short travels - unsupported**

Unsupported E-Chains® feature positive camber over short travels. This must be accounted for when specifying the clearance height  $H_F$ . Please consult igus® if space is particularly restricted.

The required clearance height:  
 $H_F = H + 50$  mm  
 (with 2,0 kg/m fill weight)

**Long travel lengths from 10 m to max. 150 m    Chain length =  $S/2 + K_2$**

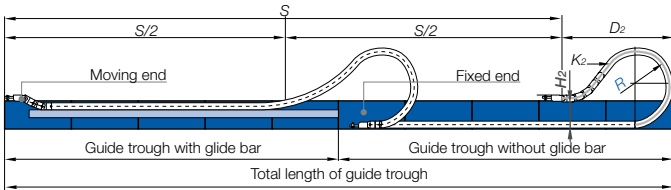

In case of travels between 4 and 10 m we recommend a longer unsupported length.



**Gliding, long travel applications (max. 150 m)**

In this case the E-Chain® upper run will be introduced in a guide trough on the lower run. We recommend to realize the engineering of such a plant by our technicians.

Speed / acceleration $FL_G$	max. 20 [m/s] / max. 200 [m/s²]
Speed / acceleration $FL_B$	max. 3 [m/s] / max. 6 [m/s²]
Gliding speed / acceleration (maximum)	max. 10 [m/s] / max. 50 [m/s²]
Material - permitted temperature °C	igumid G / -40° up to +120° C
Flammability class, igumid G	VDE 0304 IIC UL94 HB

**Technical Data**



Details of material properties  
 ► page 1.38



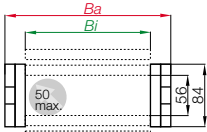

Part No. structure

14040.13.250.0



Series 14040 - E-Chain® with crossbars every link

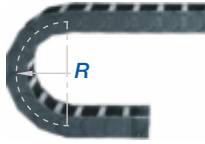

- Crossbars every link
- For rigid hydraulic hoses
- For applications particularly demanding
- Can be opened from two sides

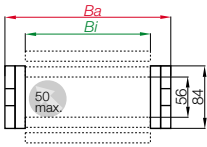

Part No. structure

14140.13.250.0



Series 14140 - E-Chain® with crossbars every 2<sup>nd</sup> link

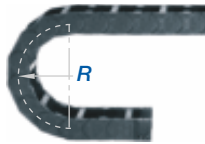

- Crossbars every 2<sup>nd</sup> link = Standard
- For nearly every situation
- Can be opened from two sides
- Easy assembly
- Stable
- Attractive price

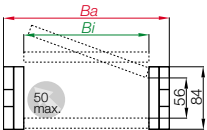

Part No. structure

18840.25.250.0



Series R18840 - Fully enclosed E-Tube

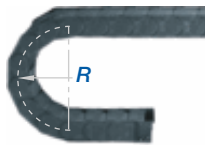

- Fully enclosed
- Excellent cable protection against dirt
- Protection against hot chips (up to 900°C)
- Lids along the entire inner radius are completely removable. Lids along the entire outer radius are single sided snap-open with a hinge on the other side to keep them attached to the chain or completely removable.



Series R188 for side-mounted applications; chip-proof tube from the E4 assembly kit on a machine tool here

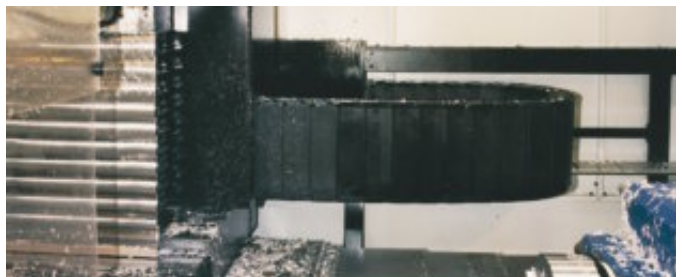

Part No.	Bi		Ba	14040	14140	R18840
	[mm]	[mm]	[mm]	[kg/m]	[kg/m]	[kg/m]
14040/14140.05.	0	50	76	≈ 2,66	≈ 2,48	-
14040/14140.06.	0	65	91	≈ 2,47	≈ 2,51	-
14040/14140/18840.07.	0*	75	101	≈ 2,75	≈ 2,25	≈ 3,20
14040/14140/18840.10.	0	100	126	≈ 2,93	≈ 2,61	≈ 3,49
14040/14140.11.	0	112	139	≈ 3,06	≈ 2,67	-
14040/14140/18840.12.	0	125	151	≈ 3,12	≈ 2,71	≈ 3,85
14040/14140.13.	0	137	164	≈ 3,26	≈ 2,77	-
14040/14140/18840.15.	0	150	176	≈ 3,32	≈ 2,81	≈ 4,28
14040/14140.16.	0	162	189	≈ 3,43	≈ 2,86	-
14040/14140.17.	0	175	201	≈ 3,54	≈ 2,92	-
14040/14140.18.	0	187	214	≈ 3,65	≈ 2,97	-
14040/14140/18840.20.	0	200	226	≈ 3,67	≈ 2,98	≈ 4,85
14040/14140.21.	0	212	239	≈ 3,78	≈ 3,04	-
14040/14140.22.	0	225	251	≈ 3,85	≈ 3,07	-
14040/14140.23.	0	237	264	≈ 3,98	≈ 3,14	-
14040/14140/18840.25.	0	250	276	≈ 4,07	≈ 3,18	≈ 5,58
14040/14140.26.	0	262	289	≈ 4,16	≈ 3,22	-
14040/14140.27.	0	275	301	≈ 4,27	≈ 3,28	-
14040/14140.28.	0	287	314	≈ 4,29	≈ 3,29	-
14040/14140/18840.30.	0	300	326	≈ 4,51	≈ 3,40	≈ 6,24
14040/14140.31.	0	312	339	≈ 4,57	≈ 3,42	-
14040/14140.32.	0	325	351	≈ 4,60	≈ 3,44	-
14040/14140.33.	0	337	364	≈ 4,77	≈ 3,53	-
14040/14140/18840.35.	0	350	376	≈ 4,93	≈ 3,61	≈ 6,99
14040/14140.36.	0	362	389	≈ 4,94	≈ 3,61	-
14040/14140.37.	0	375	401	≈ 4,95	≈ 3,62	-
14040/14140.38.	0	387	414	≈ 5,04	≈ 3,66	-
14040/14140/18840.40.	0	400	426	≈ 5,24	≈ 3,76	≈ 7,94
14040/14140.41.	0	412	439	≈ 5,39	≈ 3,84	-
14040/14140.42.	0	425	451	≈ 5,54	≈ 3,92	-
14040/14140.43.	0	437	464	≈ 5,61	≈ 3,95	-
14040/14140.45.	0	450	476	≈ 5,68	≈ 3,98	-
14040/14140/18840.46.	0	462	489	≈ 5,70	≈ 3,99	≈ 8,40
14040/14140.47.	0	475	501	≈ 5,83	≈ 4,06	-
14040/14140.48.	0	487	514	≈ 5,86	≈ 4,08	-
14040/14140.50.	0	500	526	≈ 5,96	≈ 4,13	-
14040/14140.51.	0	512	539	≈ 5,98	≈ 4,14	-
14040/14140.52.	0	525	551	≈ 6,03	≈ 4,16	-
14040/14140.53.	0	537	564	≈ 6,18	≈ 4,24	-
14040/14140.55.	0	550	576	≈ 6,67	≈ 4,48	-
14040/14140.60.	0	600	626	≈ 6,98	≈ 4,58	-

Available bending radii

R [mm] 135\*\* 150 175 200 250 300 400 500

Supplement Part No. with required radius. Example: 14040.30.300.0

0 = standard color, other colors ▶ page 1.39 · Pitch = 91 mm/link · Links/m = 11

\*Removable lid only, no hinged option · \*\*not available for R18840

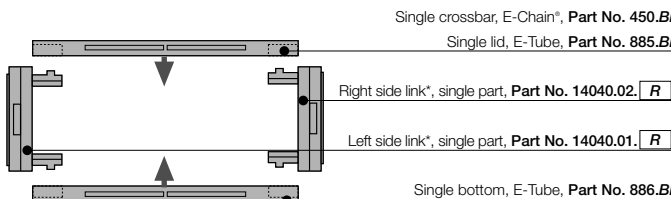

Part No. E-Chain® - links, single parts

\*View from the fixed point of the E-Chain®/E-Tube

TIP!  
**Hot Chips up to 850°C**  
 E-Tubes that repel hot chips, up to 850 °C  
 Some applications, depending on amount and size of the chips, can burn or melt the surface. That is no longer the case with the new igus® "Igmid HT" material.  
 Further information: [www.igus.de/en/HT](http://www.igus.de/en/HT) or phone: +49-0 22 03-96 49-800

System E4/light  
 Inner height: 56 mm

Phone +49- (0) 22 03-96 49-800  
 Fax +49- (0) 22 03-96 49-222



▶ page 7.161



**Option 1**

- Vertical separators
- Spacers
- Locking separators
- Asymmetric separators

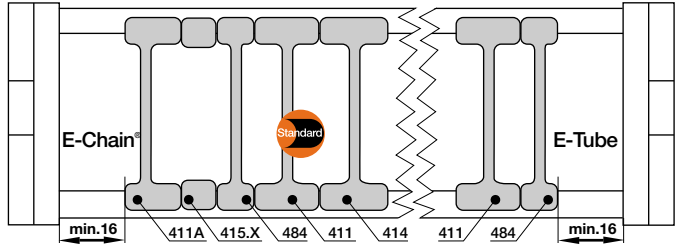

Vertical separator  
401



Vertical separator  
483



Spacer  
405.10



Spacer  
405.15



Spacer  
405.20



Spacer  
405.30



Spacer  
405.40



Locking separator  
404



Asymmetric  
separator 401A

<b>Vertical separator for E-Chains®/E-Tubes</b>	
unassembled	401
assembled	411



<b>Vertical separator for E-Chains®/E-Tubes</b>	
unassembled	483
assembled	484



<b>Spacer* for E-Chains®</b>	
unassembled	405.10
assembled	415.10



<b>Spacer* for E-Chains®</b>	
unassembled	405.15
assembled	415.15



<b>Spacer* for E-Chains®</b>	
unassembled	405.20
assembled	415.20



<b>Spacer* for E-Chains®</b>	
unassembled	405.30
assembled	415.30



<b>Spacer* for E-Chains®</b>	
unassembled	405.40
assembled	415.40



<b>Locking separator for E-Chains®</b>	
unassembled	404
assembled	414



<b>Asymmetric separator* for E-Chains®</b>	
unassembled	401A
assembled	411A



\*For side-mounted applications

**Option 1: Vertical separators and spacers**

Vertical separators are used if a vertical subdivision of the E-Chain® interior is required - By standard vertical separators are assembled every other E-Chain® link. **Note:** Observe a lateral spacing of at least 16 mm!

● **Standard separator 401 for E-Chains® and E-Tubes** offers safe stability due to its wide base design, also when used with thick cables or hoses.

● **Vertical separator 483 with a narrow base for E-Chains® and E-Tubes** with applications where a large number of small cables need to be individually separated.

● Vertical separators in side-mounted applications, for instance, can be fixed in position by means of **spacer 405.X for E-Chains®**. A wide range of intervals between the vertical separators is adjustable here.

● **Note on spacers:** The available interior height is reduced by 2 mm per spacer (4 mm when spacers are fitted on both sides). To avoid this, the parts can also be installed from the outside on the opening crossbar.

**Additionally:**

● **Locking separator for E-Chains® 404** - with increased retention force for applications exposed to very high humidity or extreme loads. The extra retention force is achieved by asymmetric claws for the crossbar. Ensure proper alignment.

● **Locking separator 406 for E4-Tubes** - safe fitting locked on lid or bottom of the Tube and sideways slideable. The opposing lid or bottom can easily be opened and closed. Especially capable if many separators need to be assembled on a tight inner width. **Art. Nr. not assembled 406 - Art. Nr. assembled 416.** For illustration, refer to **vertical separator 404.**

● **Asymmetric separator 401A for E-Chains®** (not for E-Tubes) with an 18-mm base, for combinations between spacers of different widths and vertical separators in side-mounted applications, for instance.

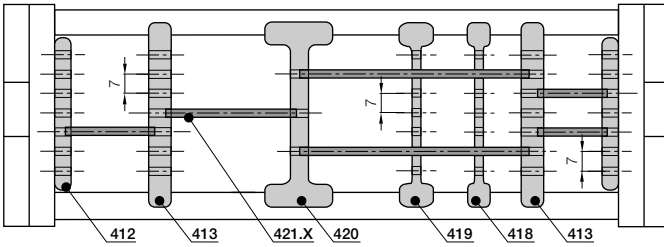

**Option 2**

- Side plates
- Middle plates
- Locking vertical separators
- Slotted separators
- Open slotted separators

**Option 2: Shelves**

For applications involving many cables with different diameters. The shelves can be arranged elevator-shifted with different bottoms.

- Side plates 402, middle plates 403 and shelves 420.X form the basic pattern of a shelf system. Shelves of various widths can be arranged at 7 different heights (in 7 mm increments).
- Locking vertical separator 410, slotted combined with shelves.
- Slotted separators 408 are used for very fine subdivisions. However, they cannot be retrofitted into an existing separation system without dismantling the interior separators first.
- The unilateral open slotted separator 409 can be retrofitted into an existing interior separation system without a need for dismantling the interior separators. During an installation of open slotted separators, the top and bottom notches cannot be occupied by shelves.



Side plate for E-Chains®/E-Tubes		
unassembled	402	
assembled		412



Middle plate for E-Chains®/E-Tubes		
unassembled	403	
assembled		413



Locking vertical separator for E-Chains®/E-Tubes		
unassembled	410	
assembled		420



Slotted separator for E-Chains®/E-Tubes		
unassembled	408	
assembled		418



Open slotted separator for E-Chains®/E-Tubes		
unassembled	409	
assembled		419

Width X [mm]	Part No. unassembled	Part No. assembled
18	420.18	421.18
23	420.23	421.23
25	420.25	421.25
28	420.28	421.28
33	420.33	421.33
43	420.43	421.43
50	420.50	421.50
62	420.62	421.62

Width X [mm]	Part No. unassembled	Part No. assembled
75	420.75	421.75
88	420.88	421.88
100	420.100	421.100
125	420.125	421.125
150	420.150	421.150
175	420.175	421.175
187	420.187	421.187
200	420.200	421.200



Side plate 402



Middle plate 403



Locking vertical separator 410



Slotted separator 408



Open slotted separator 409



Shelf 420.X

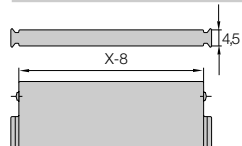

**Additional elements for interior separation**

	<b>Center crossbar</b>	
	unassembled	405
	assembled	415

**Center crossbar** - was developed for applications with a large number of thin cables. The center crossbar offers the option of subdividing the E-Chain® independently into upper and lower halves.

	<b>Rollclip</b>	
	unassembled	489.27
	assembled	490.27

**Rollclip** - minimizes abrasion of particularly sensitive hoses. The Rollclip is simply clamped onto the opening crossbar. The movable rollers compensate for relative movement between the chain and hose.

	<b>Roller separator</b>	
	unassembled	429
	assembled	430

**Roller separator** - performs a similar function to the Rollclip, but doubles as a separator.





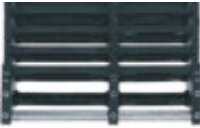

Part No. structure  
14040.10 /20 /10. 200.0  
14040.*Bi1/Bi2/Bi3*. R.0

### Extension links - for extremely wide E-Chains® up to 3,0 m

- For applications in which particularly high fill weights necessitate extremely wide E-Chains® (up to 3000 mm)
- The extension link design allows virtually limitless side-by-side attachment of chains
- The unsupported length of a chain can be increased when additional loads are required
- Extension links can be used with E-Chains®, E-Tubes or as a combination of both
- They are suitable for unsupported and gliding applications in a guide trough
- E-Chains® with extension links are attached with KMA or steel mounting brackets

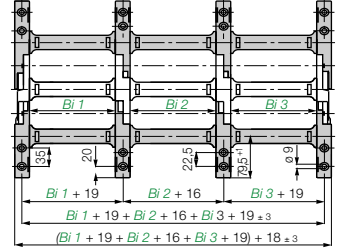

Consult igus® for your extender crossbar applications. We are happy to assist you with your design layout

### Extender crossbars - careful guide of hoses applications

- Suitable for hoses with a maximum outer diameter of 300 mm
- Gliding operation with crossbars assembled along the outer radius and a special guide trough
- Gliding operation not guaranteed with crossbars assembled along the inner radius
- The extender crossbar can either be attached to the side links directly or can be used in combination with two stranded snap-open crossbars

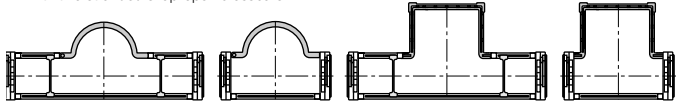

Round extender crossbar with snap-open crossbars    Attached directly to the side link    Square extender crossbar with snap-open crossbars    Attached directly to the side link

Part No.	Max Ø [mm] hose	Form	Installation side link	Combination with snap-open crossb.
450.15.RHD115	115	○	-	+
450.17.RD115	115	○	+	-
450.25.D150	150	□	+	-
450.30.D200	180	□	+	-
450.35.D250	155	□	+	-
450.40.D300	245	□	+	-
450.20.HD150	245	□	-	+
450.25.HD200	245	□	-	+
450.30.HD250	245	□	-	+

○ = round    □ = square    + = yes / - = no



### E4 clip-on cable binder

- For side-mounted applications    ● Serves as a clip-on, lateral guide for hoses and cables on E-Chains®
- The loops can be adjusted as required    ● Compatible with many E4 E-Chains®    ● Stylish and economical
- One clip and one locking band are needed for each chain link    ● Call us if you have any questions on project planning

Part No.	Form
450.B12	Locking clip, comprising a locking element
450.B12.200	Locking band, comprising a locking element and band; 12 x 1,5 x 200 mm

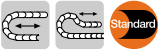

### The Standard - Option KMA\* - pivoting

- Recommended for unsupported and gliding applications
- Confined installation conditions
- Option - integrated C-profile strain relief device with Chainfix clip or strain relief tiwrap plates
- Corrosion resistant
- Universal mountable with attachment capability on all sides

\*KMA = Polymer Metal Mounting Bracket

Moving end

141400/189400...2

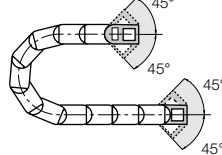

Fixed end

141400/189400...1



The attachment variants arising automatically by the choice of the KMA mounting bracket

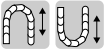
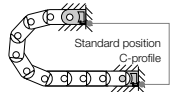

### Option KMA - locking

- Recommended for vertical hanging / standing applications

#### Additionally:

- Universal mountable
- C-profile option
- Corrosion resistant
- Locked connections
- At very high acceleration

Moving end

140400/188400...2

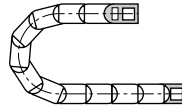

Fixed end

140400/188400...1



The attachment variants arising automatically by the choice of the KMA mounting bracket

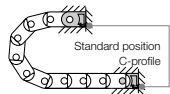

Fixed end

141400/189400...1 (pivoting)  
140400/188400...1 (locking)

Moving end  
(pivoting) 141400/189400...2  
(locking) 140400/188400...2

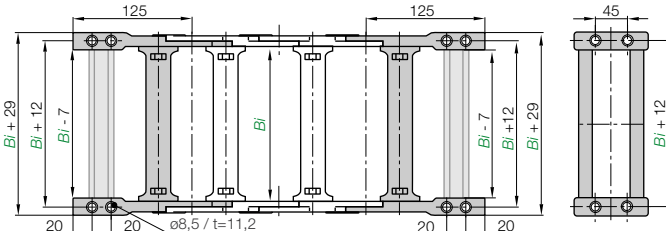

### Dimensions and order configurations

Part No. structure (pivoting)

141400.07.12.C  
189400.07.12.C

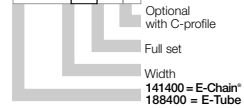

Optional with C-profile

Full set

Width  
141400 = E-Chain\*  
188400 = E-Tube

Part No. structure (locking)

140400.07.12.C  
188400.07.12.C

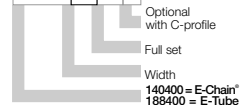

Optional with C-profile

Full set

Width  
140400 = E-Chain\*  
188400 = E-Tube

Width 141400				Width 188400			
index	Part No.	full set	C-profile Bi	index	Part No.	full set	C-profile Bi
	pivoting	locking	option [mm]		pivoting	locking	option [mm]
.05.	▶ 141400	140400	05.12. C 50	.32.	▶ 141400	140400	32.12. C 325
.06.	▶ 141400	140400	06.12. C 65	.33.	▶ 141400	140400	33.12. C 337
.07.	▶ 141400/189400	140400/188400	07.12. C 75	.35.	▶ 141400/189400	140400/188400	35.12. C 350
.10.	▶ 141400/189400	140400/188400	10.12. C 100	.36.	▶ 141400	140400	36.12. C 362
.11.	▶ 141400	140400	11.12. C 112	.37.	▶ 141400	140400	37.12. C 375
.12.	▶ 141400/189400	140400/188400	12.12. C 125	.38.	▶ 141400	140400	38.12. C 387
.13.	▶ 141400	140400	13.12. C 137	.40.	▶ 141400/189400	140400/188400	40.12. C 400
.15.	▶ 141400/189400	140400/188400	15.12. C 150	.41.	▶ 141400	140400	41.12. C 412
.16.	▶ 141400	140400	16.12. C 162	.42.	▶ 141400	140400	42.12. C 425
.17.	▶ 141400	140400	17.12. C 175	.43.	▶ 141400	140400	43.12. C 437
.18.	▶ 141400	140400	18.12. C 187	.45.	▶ 141400	140400	45.12. C 450
.20.	▶ 141400/189400	140400/188400	20.12. C 200	.46.	▶ 141400/189400	140400/188400	46.12. C 462
.21.	▶ 141400	140400	21.12. C 212	.47.	▶ 141400	140400	47.12. C 475
.22.	▶ 141400	140400	22.12. C 225	.48.	▶ 141400	140400	48.12. C 487
.23.	▶ 141400	140400	23.12. C 237	.50.	▶ 141400	140400	50.12. C 500
.25.	▶ 141400/189400	140400/188400	25.12. C 250	.51.	▶ 141400	140400	51.12. C 512
.26.	▶ 141400	140400	26.12. C 262	.52.	▶ 141400	140400	52.12. C 525
.27.	▶ 141400	140400	27.12. C 275	.53.	▶ 141400	140400	53.12. C 537
.28.	▶ 141400	140400	28.12. C 287	.55.	▶ 141400	140400	55.12. C 550
.30.	▶ 141400/189400	140400/188400	30.12. C 300	.60.	▶ 141400	140400	60.12. C 600
.31.	▶ 141400	140400	31.12. C 312				

Full set, for both ends:

141400.05.12

Single-part order:

141400.05.1

Mounting bracket with bore

141400.05.2

Mounting bracket with pin



igus® Chainfix steel clamps and Chainfix stainless-steel clamps - max. pull forces, adjustable with hexagon socket. Available as single, double or triple clamps.

Details ► chapter 10

### Chainfix clamps for the C-profile

Part No. single clamps		Part No. double clamps		Part No. triple clamps		Cable
steel	stainless steel	steel	stainless steel	steel	stainless steel	ø [mm]
CFX12.1	CFX12.1.E	CFX12.2	CFX12.2.E	CFX12.3	-	06 - 12
CFX14.1	CFX14.1.E	CFX14.2	CFX14.2.E	CFX14.3	-	12 - 14
CFX16.1	CFX16.1.E	CFX16.2	CFX16.2.E	CFX16.3	-	14 - 16
CFX18.1	CFX18.1.E	CFX18.2	CFX18.2.E	CFX18.3	-	16 - 18
CFX20.1	CFX20.1.E	CFX20.2	CFX20.2.E	CFX20.3	-	18 - 20
CFX22.1	CFX22.1.E	CFX22.2	CFX22.2.E	CFX22.3	-	20 - 22
CFX26.1	CFX26.1.E	CFX26.2	CFX26.2.E	-	-	22 - 26
CFX30.1	CFX30.1.E	CFX30.2	CFX30.2.E	-	-	26 - 30
CFX34.1	CFX34.1.E	CFX34.2	CFX34.2.E	-	-	30 - 34
CFX38.1	CFX38.1.E	-	-	-	-	34 - 38
CFX42.1	CFX42.1.E	-	-	-	-	38 - 42



### Chainfix Clip - Modular snap-on strain relief device for C-profile

Available for all igus® E-ChainSystems® with C-profiles and also suitable for assembly in the KMA mounting brackets and clip-on strain relief for crossbars. High pull forces, plug-in modular snap-on strain relief device. Details ► chapter 10

Cable ø [mm]	Part No. clamp	Part No. bottom part
04 - 08	CFC-08-M	CFC-08-C
08 - 12	CFC-12-M	CFC-12-C
12 - 16	CFC-16-M	CFC-16-C
16 - 20	CFC-20-M	CFC-20-C
20 - 24	CFC-24-M	CFC-24-C



### Chainfix Nugget for the C-Profile

Strain relief for the fixation of cables up to a diameter of Ø 20 mm. Easy to assemble, without any screws and tools. Easy strain relief due to fixation with pre-hammered cable strap, very small space requirement.

Details ► chapter 10

Part No.	ø max. conduit [mm]	Width [mm]
CFN.20	20	10,8

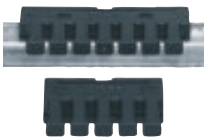

### Chainfix tiwrap plates with clip-on connection for the C-profile

Can be plugged into the KMA C-profile. Easy to assemble without any screws. Easily solvable with screwdriver nevertheless safe stop. For all E-Chains® with KMA and integrated C-profile. Details ► chapter 10

Part No.	Width of strain relief [mm]	Number of teeth
3050.ZC	50	5
3075.ZC	75	7

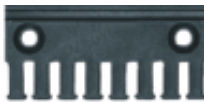

Single tiwrap plate

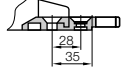

Shown assembled

### Tiwrap plate as individual part

As individual component screwed on KMA. Can be plugged in the mounting brackets. Details ► chapter 10

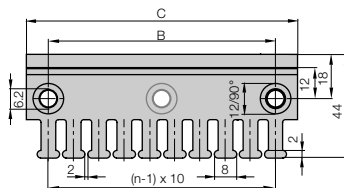

Tiwrap plate	No. of teeth n	Dim. C [mm]	Dim. B [mm]	Center bore
3050.ZB	5	50	30	-
3075.ZB	7	75	55	-
3100.ZB	10	100	80	-
3115.ZB	11	115	95	-
3125.ZB	12	125	105	-
3150.ZB	15	150	130	-
3175.ZB	17	175	155	-
3200.ZB	20	200	180	+
3225.ZB	22	225	205	+
3250.ZB	25	250	230	+

(- = no / + = yes)

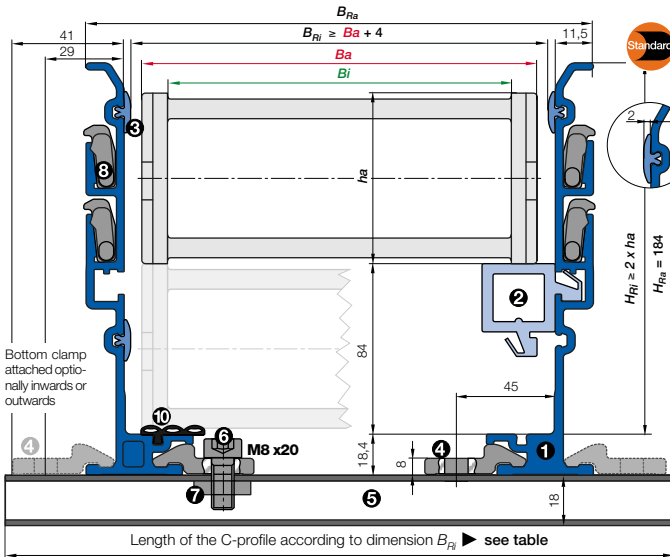

- $B_a$  = Outer width E-Chains\* / E-Tube
  - $B_i$  = Inner width E-Chains\* / E-Tube
  - $h_a$  = Outer height E-Chains\* / E-Tube
  - $H_{Ri}$  = Inner trough height
  - $H_{Ra}$  = Outer trough height
  - $B_{Ri}$  = Inner trough width ► depends on dim.  $B_a$
  - $B_{Ra}$  = Outer trough width
  - $n_{Mon}$  = Number of installation sets (left/right)
  - $n_{Ri}$  = Number of trough sets (left/right)
- $H_{Ri} \geq 2 \cdot h_a$   
 $B_{Ri} \geq B_a + 4$
- = Guide trough set
  - = Installation set "Basic"
  - = C-profile
  - = Glide bar

**Installation set "Basic" with C-profile**

Bottom Clamp attached optionally inwards or outwards ►

14040.05.200.0 ► Order example

$B_{Ri}$ [mm]	Part No.	
	attached inwards	attached outwards
.05 80	-	960.50.200
.06 95	-	960.50.225
.07 105	-	960.50.225
.10 130	960.50.200	960.50.250
.11 143	960.50.200	960.50.275
.12 155	960.50.225	960.50.275
.13 168	960.50.225	960.50.300
.15 180	960.50.250	960.50.300
.16 193	960.50.250	960.50.325
.17 205	960.50.275	960.50.325
.18 218	960.50.275	960.50.350
.20 230	960.50.300	960.50.350
.21 243	960.50.300	960.50.375
.22 255	960.50.325	960.50.375
.23 268	960.50.325	960.50.400
.25 280	960.50.350	960.50.400
.26 293	960.50.350	960.50.425
.27 305	960.50.375	960.50.425
.28 318	960.50.375	960.50.450
.30 330	960.50.400	960.50.450
.31 343	960.50.400	960.50.475
.32 355	960.50.425	960.50.475
.33 368	960.50.425	960.50.500
.35 380	960.50.450	960.50.500
.36 393	960.50.450	960.50.525
.37 405	960.50.475	960.50.525
.38 418	960.50.475	960.50.550
.40 430	960.50.500	960.50.550
.41 443	960.50.500	960.50.575
.42 455	960.50.525	960.50.575
.43 468	960.50.525	960.50.600
.45 480	960.50.550	960.50.600
.46 493	960.50.550	960.50.625
.47 505	960.50.575	960.50.625
.48 518	960.50.575	960.50.650
.50 530	960.50.600	960.50.650
.51 543	960.50.600	960.50.675
.52 555	960.50.625	960.50.675
.53 568	960.50.625	960.50.700
.55 580	960.50.650	960.50.700
.60 630	960.50.700	960.50.750



- **Components, trough "Basic":** ① Trough side parts, aluminum, 2 m ② Glide bar, plastic, 2 m ③ Glide strips, plastic, 2 m (without glide strips on request) ⑩ Optional: Silencer profile, rubber
- **Components, installation set "Basic":** ④ Bottom clamp, aluminum ⑤ C-profile, steel galvanized ⑥ Screw M8 x20 ⑦ Sliding nut M8 ⑧ Interface connector, plastic



**Order example: Length of travel 30 m - Center mounted for Series 14040.10.200.0 with  $B_{Ri} = 130$**

Guide trough set (set of 2 trough side parts, incl. glide strips) <b>without</b> glide bar	Part No.	974.30.SL
Order text: 16 m guide trough without glide bar (8 x 2 m sections)		
Guide trough set (set of 2 trough side parts, incl. glide strips) <b>with</b> glide bar	Part No.	974.31.SL
Order text: 16 m guide trough with glide bar (8 x 2 m sections)		
Installation set "Basic" complete (guide trough-sets + 1)	Part No.	960.50.200
Order text: 17 installation sets "Basic"		
Module for the fixed end	Part No.	974.81
Order text: 1 set		
Option: For an additional noise dampening with silencer profile, please add Index A - Example:	Part No.	974.30.SLA



Principle sketch: Number of installation sets to be installed = **Number of trough sections + 1**

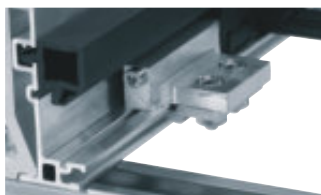

**NEW! A quick fix for mounting the stationary end of an E-Chain®**

With this new module for the fixed end, fast and easy mounting onto the Aluminum "SuperTrough" is now possible without any drilling. Fast mounting of the E-Chain® by clamping onto the aluminum trough

- Quick relocation of the stationary end
- No drilling necessary ► page 9.16

Insert for the installation set "Heavy-Duty": **974.50.XXX** instead of (960.50.XXX) on the right column "attached outwards"



► Chapter 10



► Chapter 9



► page 7.161

Price index



Series 14240    Series 14340



**ESD classification:**  
Electrically conductive ESD/ATEX  
version upon request



**High torsional  
rigidity**



**Side-mounted -  
unsupported**



**Opening E-Chains®:** Remove crossbars and clips - Insert screwdriver into the slot, push down, release by lever action



**When to use the Series 14240/14340:**

- For achieving simple, economical solutions
- For achieving the ideal ratio between internal and external dimensions
- For use if Series 400 proves too large



**When not to use it:**

- If a quieter version is required
  - ▶ Series 400/410/R880, page 7.48
- If long side-mounted, unsupported length is required
  - ▶ Series 4040/4140/R8840, page 7.118
- If an increased inner height is required
  - ▶ Series 15050, page 7.182

- ❶ Crossbars on E-Chains® are removable along both radii
- ❷ Wide, rounded plastic crossbars - cable friendly
- ❸ Optimum ratio of inner height to outer height
- ❹ Lateral glide surfaces for side-mounted operation
- ❺ Integrated strain relief possible
- ❻ Locking or pivoting mounting brackets available
- ❼ KMA mounting brackets with attachment points on all sides
- ❽ New stronger version with "tongue-and-groove-design"
- ❾ Numerous interior separation possibilities
- ❿ E-Chains® also available with reverse bending radius "RBR"

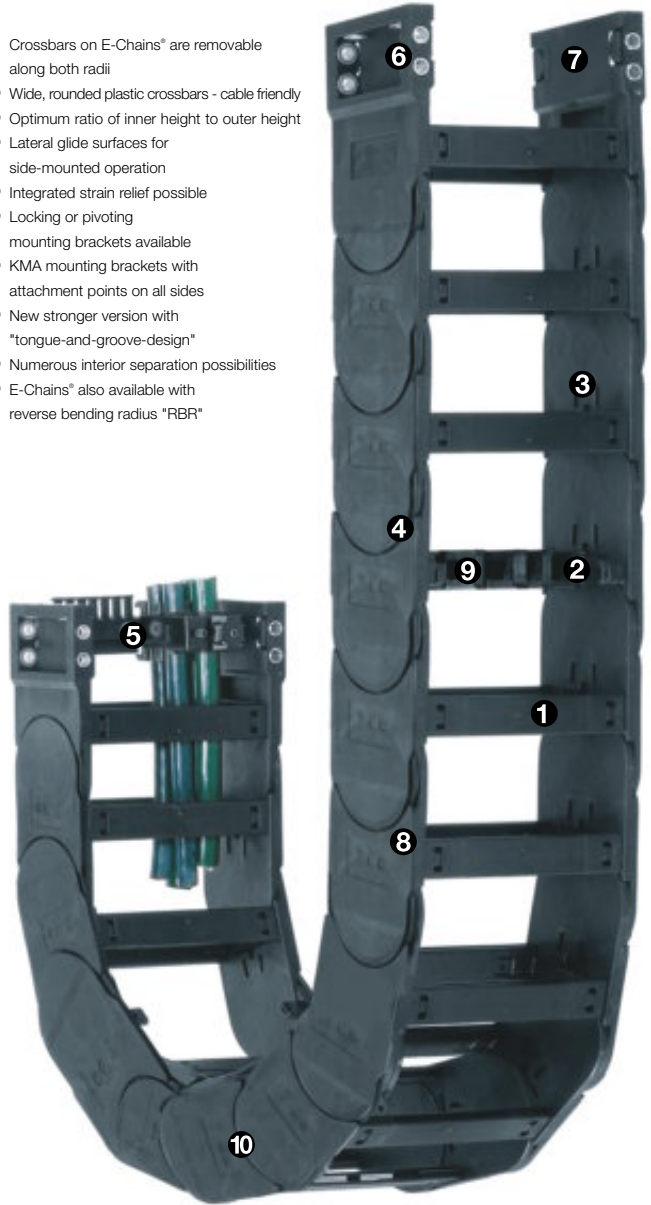

**Order example complete E-Chain®**

Please indicate chain-lengths or number of links **Example: 6 m or 66 links**

6 m **14240.30.300.0**

**E-Chain®**

with 2 separators **417** assembled every 2<sup>nd</sup> link

**Interior separation**

1 set **142400.30.12.C**

**Mounting bracket**

**Unsupported length**

$FL_G$  = with straight upper run  
 $FL_B$  = with permitted sag  
 Further information ► **Design, page 1.12**

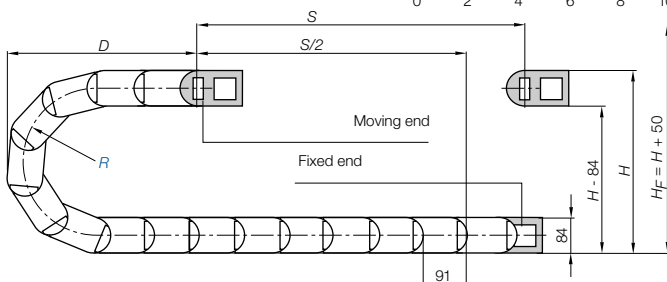
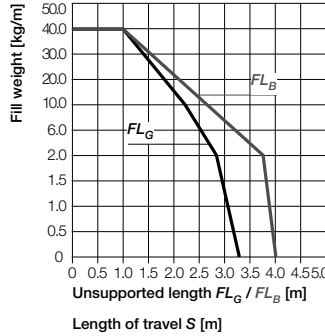
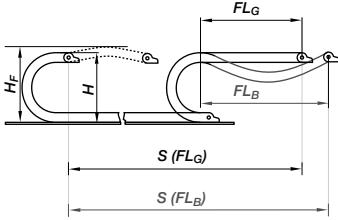

Pitch = 91 mm/link    Links/m = 11 (1001 mm)    Chain length =  $S/2 + K$

R	135	150	175	200	250	300	400	500
$H_{25}^{\circ}$	360	385	435	485	585	685	885	1085
D	270	285	310	335	385	435	535	635
K	650	750	825	900	1050	1225	1450	1775
$D_2^{+25}$	390	450	550	710	920	1120	1530	1850
$K_2$	728	819	1001	1274	1638	1911	2548	3185
$H_2$	266	266	266	266	266	266	266	266

- S = Length of travel
- R = Bending radius
- H = Nominal clearance height
- $H_F$  = Required clearance height
- $H_{in}$  = Trough inner height
- D = Overlength E-Chain® radius in final position
- $K = \pi \cdot R + \text{"safety"}$
- $D_2$  = Over length - long travels, gliding
- $K_2$  = "Further add-on"
- $H_2$  = "Mounting height"
- \*if the mounting bracket location is set lower

**Other installation methods**

- Vertical, hanging  $\leq 80$  m
- Vertical, standing  $\leq 6$  m
- Side mounted, un supp.  $\leq 2$  m
- Rotary requires further calculation
- Unsupported length of upper run = upon request

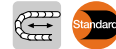

**Short travels - unsupported**

Unsupported E-Chains® feature positive camber over short travels. This must be accounted for when specifying the clearance height  $H_F$ . Please consult igus® if space is particularly restricted.

The required clearance height:  
 $H_F = H + 50$  mm  
 (with 2,0 kg/m fill weight)

**Long travel lengths from 10 m to max. 150 m**    Chain length =  $S/2 + K_2$

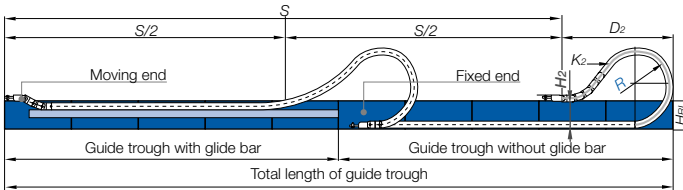

In case of travels between 4 and 10 m we recommend a longer unsupported length.



**Gliding, long travel applications (max. 150 m)**

In this case the E-Chain® upper run will be introduced in a guide trough on the lower run. We recommend to realize the engineering of such a plant by our technicians.

Speed / acceleration $FL_G$	max. 20 [m/s] / max. 200 [m/s <sup>2</sup> ]
Speed / acceleration $FL_B$	max. 3 [m/s] / max. 6 [m/s <sup>2</sup> ]
Gliding speed / acceleration (maximum)	max. 10 [m/s] / max. 50 [m/s <sup>2</sup> ]
Material - permitted temperature °C	igumid G / -40° up to +120° C
Flammability class, igumid G	VDE 0304 IIC UL94 HB

**Technical Data**



Details of material properties  
 ► page 1.38

62

System E4/light  
 Inner height: 62 mm

Phone +49- (0) 22 03-96 49-800  
 Fax +49- (0) 22 03-96 49-222



► page 7.161



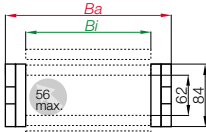

Part No. structure

14240.12.250.0



Series 14240 - E-Chain® with crossbars every link

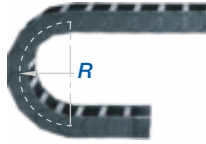

- Crossbars every link
- For rigid hydraulic hoses
- For applications particularly demanding
- Can be opened from two sides

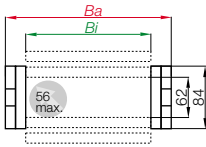

Part No. structure

14340.12.250.0



Series 14340 - E-Chain® with crossbars every 2<sup>nd</sup> link

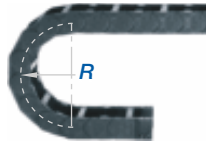

- Crossbars every 2<sup>nd</sup> link = Standard
- For nearly every situation
- Can be opened from two sides
- Easy assembly
- Stable
- Attractive price



Vertical, standing  
installation on a machine  
tool with Series 142

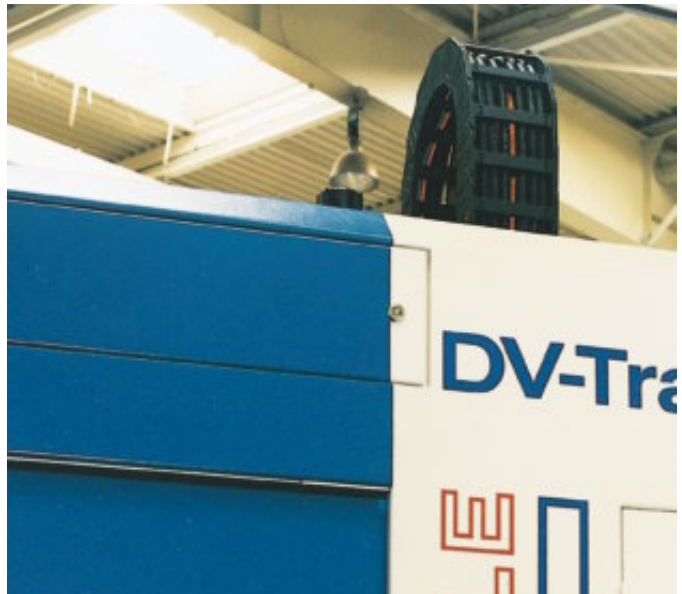



Part No.	<i>Bi</i> [mm]	<i>Ba</i> [mm]	14240 [kg/m]	14340 [kg/m]
14240/14340.05. <input type="text"/> .0	50	76	≈ 2,37	≈ 2,32
14240/14340.06. <input type="text"/> .0	68	94	≈ 2,40	≈ 2,33
14240/14340.07. <input type="text"/> .0	75	101	≈ 2,42	≈ 2,34
14240/14340.087. <input type="text"/> .0	87	114	≈ 2,47	≈ 2,36
14240/14340.10. <input type="text"/> .0	100	126	≈ 2,52	≈ 2,39
14240/14340.11. <input type="text"/> .0	108	134	≈ 2,55	≈ 2,40
14240/14340.112. <input type="text"/> .0	112	139	≈ 2,55	≈ 2,41
14240/14340.12. <input type="text"/> .0	125	151	≈ 2,62	≈ 2,44
14240/14340.137. <input type="text"/> .0	137	164	≈ 2,66	≈ 2,46
14240/14340.15. <input type="text"/> .0	150	176	≈ 2,72	≈ 2,49
14240/14340.162. <input type="text"/> .0	162	189	≈ 2,73	≈ 2,49
14240/14340.17. <input type="text"/> .0	168	194	≈ 2,79	≈ 2,52
14240/14340.18. <input type="text"/> .0	175	201	≈ 2,82	≈ 2,53
14240/14340.187. <input type="text"/> .0	187	214	≈ 2,84	≈ 2,55
14240/14340.20. <input type="text"/> .0	200	226	≈ 2,89	≈ 2,58
14240/14340.212. <input type="text"/> .0	212	239	≈ 2,95	≈ 2,60
14240/14340.23. <input type="text"/> .0	225	251	≈ 3,01	≈ 2,63
14240/14340.237. <input type="text"/> .0	237	264	≈ 3,04	≈ 2,65
14240/14340.25. <input type="text"/> .0	250	276	≈ 3,10	≈ 2,68
14240/14340.262. <input type="text"/> .0	262	289	≈ 3,11	≈ 2,69
14240/14340.28. <input type="text"/> .0	275	301	≈ 3,19	≈ 2,72
14240/14340.29. <input type="text"/> .0	287	314	≈ 3,20	≈ 2,73
14240/14340.30. <input type="text"/> .0	300	326	≈ 3,30	≈ 2,78
14240/14340.312. <input type="text"/> .0	312	339	≈ 3,31	≈ 2,79
14240/14340.325. <input type="text"/> .0	325	351	≈ 3,37	≈ 2,81
14240/14340.337. <input type="text"/> .0	337	364	≈ 3,40	≈ 2,83
14240/14340.350. <input type="text"/> .0	350	376	≈ 3,56	≈ 2,91
14240/14340.362. <input type="text"/> .0	362	389	≈ 3,61	≈ 2,93
14240/14340.375. <input type="text"/> .0	375	401	≈ 3,64	≈ 2,95
14240/14340.387. <input type="text"/> .0	387	414	≈ 3,69	≈ 2,97
14240/14340.400. <input type="text"/> .0	400	426	≈ 3,73	≈ 2,99

Available bending radii

R [mm]

Supplement Part No. with required radius. Example: 14240.12. .0

0 = standard color, other colors ► page 1.39 · Pitch = 91 mm/link - Links/m = 11



Extender crossbar for large diameter hoses ► page 7.146

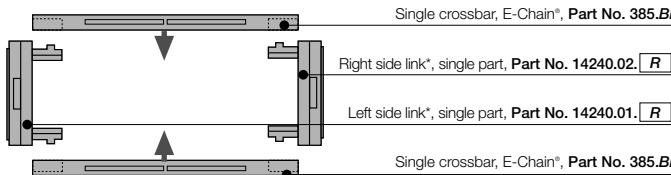

Part No. E-Chain® - links, single parts

\*View from the fixed point

System E4/light  
Inner height: 62 mm

Phone +49- (0) 22 03-96 49-800  
Fax +49- (0) 22 03-96 49-222



► page 7.161



Option 1

- Vertical separators
- Spacers

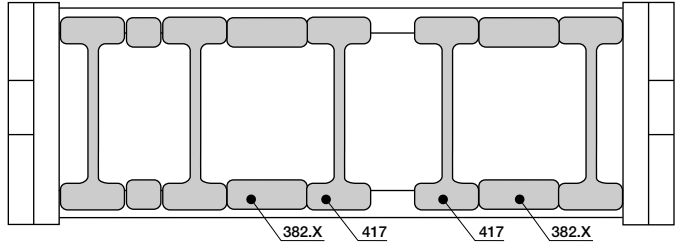

Vertical separator  
407



Spacer  
381.10



Spacer  
381.15



Spacer  
381.20

Vertical separator for E-Chains®	
unassembled	407
assembled	417



Spacer* for E-Chains®	
unassembled	381.10
assembled	382.10



Spacer* for E-Chains®	
unassembled	381.15
assembled	382.15



Spacer* for E-Chains®	
unassembled	381.20
assembled	382.20



\*For side-mounted applications

Option 1: Vertical separators and spacers

Vertical separators are used if a vertical subdivision of the E-Chain® interior is required - By standard vertical separators are assembled every other E-Chain® link.

● **Standard separator 407 for E-Chains®** offers safe stability due to its wide base design, also when used with thick cables or hoses.

● Vertical separators in side-mounted applications, for instance, can be fixed in position by means of **spacer 381.X for E-Chains®**. A wide range of intervals between the vertical separators is adjustable here.

● **Note on spacers:** The available interior height is reduced by 2 mm per spacer (4 mm when spacers are fitted on both sides). To avoid this, the parts can also be installed from the outside on the opening crossbar.

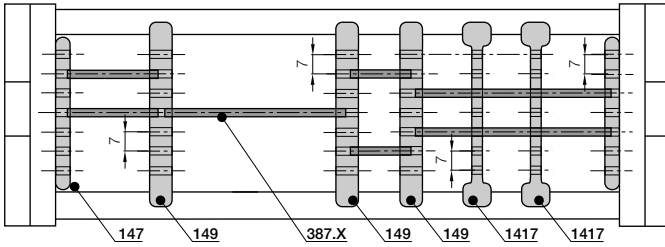

**Option 2**

- Side plates
- Middle plates
- Slotted separators

**Option 2: Shelves**

For applications involving many cables with different diameters. The shelves can be arranged elevator-shifted with different bottoms.

● Side plates 146, middle plates 148 and shelves 386.X form the basic pattern of a shelf system. Shelves of various widths can be arranged at 7 different heights (in 7 mm increments).

● Slotted separators 1407 are used for very fine subdivisions. However, they cannot be retrofitted into an existing separation system without dismantling the interior separators first.



Side plate for E-Chains®		
unassembled		146
assembled		147



Middle plate for E-Chains®		
unassembled		148
assembled		149



Slotted separator for E-Chains®		
unassembled		1407
assembled		1417

Width X [mm]	Part No. unassembled	Part No. assembled
18	386.18	387.18
23	386.23	387.23
25	386.25	387.25
28	386.28	387.28
33	386.33	387.33
43	386.43	387.43
50	386.50	387.50
54	386.54	387.54
62	386.62	387.62

Width X [mm]	Part No. unassembled	Part No. assembled
75	386.75	387.75
87	386.87	387.87
100	386.100	387.100
108	386.108	387.108
125	386.125	387.125
150	386.150	387.150
175	386.175	387.175
200	386.200	387.200
208	386.208	387.208

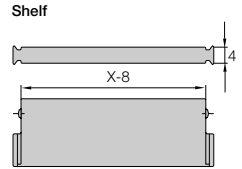
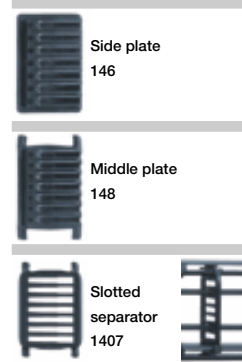

System E4/light  
Inner height: 62 mm

Phone +49- (0) 22 03-96 49-800  
Fax +49- (0) 22 03-96 49-222





Consult igus® for your extender crossbar applications. We are happy to assist you with your design layout

### Extender crossbars - careful guide of hoses applications

- Suitable for hoses with a maximum outer diameter of 115 mm
- Gliding operation with crossbars assembled along the outer radius and a special guide trough
- Gliding operation not guaranteed with crossbars assembled along the inner radius
- The extender crossbar can either be attached to the side links directly or can be used in combination with two stranded snap-open crossbars

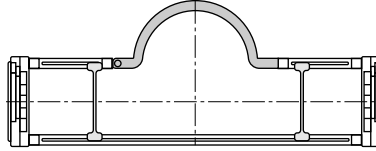

385.15RHD115 round extender crossbar combined with snap-open crossbars

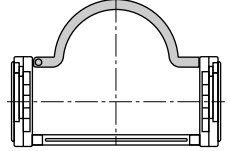

385.18RD115 round strap attached directly on the side link

Part No.	Max Ø [mm] hose	Form	Installation side link	Combination with snap-open crossb.
385.15.RHD115	115	○	-	+
385.18.RD115	115	○	+	-

○ = round + = yes / - = no



### Hinged crossbars

- Typically E-Chain® crossbars are completely removable. In cases where the snap-open crossbars have to remain at the open link of the E-Chain®, a hinged design has been developed
- Length: 37,5 mm **Part No. 385.02** / snap-open crossbar (shortened): *Bi*-37,5 mm **Part No. 385.03**
- Please consult igus® for design assistance

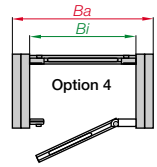
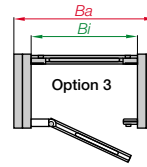
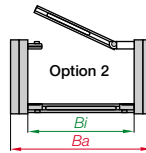
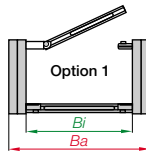
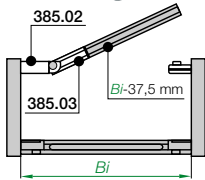

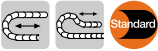

### The Standard - Option KMA\* - pivoting

- Recommended for unsupported and gliding applications
- Confined installation conditions
- Option - integrated C-profile strain relief device with Chainfix clip or strain relief tiwrap plates
- Corrosion resistant
- Universal mountable with attachment capability on all sides

\*KMA = Polymer Metal Mounting Bracket

Moving end  
143400...2

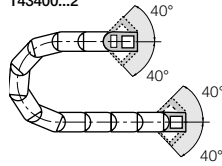

Fixed end  
143400...1



The attachment variants arising automatically by the choice of the KMA mounting bracket

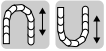
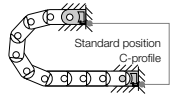

### Option KMA - locking

- Recommended for vertical hanging / standing applications

**Additionally:**

- Universal mountable
- C-profile option
- Corrosion resistant
- Locked connections
- At very high acceleration

Moving end  
142400...2

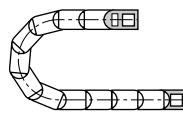

Fixed end  
142400...1



The attachment variants arising automatically by the choice of the KMA mounting bracket

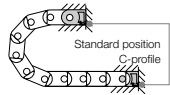

**Fixed end**

143400...1 (pivoting)

142400...1 (locking)

**Moving end**

(pivoting) 143400...2

(locking) 142400...2

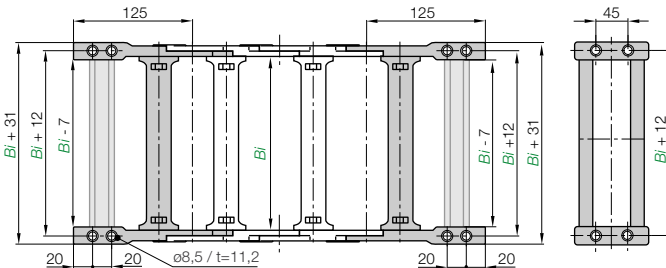

### Dimensions and order configurations

**Part No. structure (pivoting)**

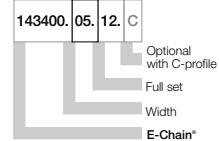

**Part No. structure (locking)**

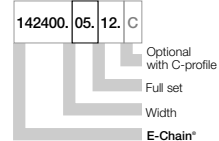

Width index	Part No. pivoting	Part No. locking	C-profile option [mm]	Bi [mm]	Width index	Part No. pivoting	Part No. locking	C-profile option [mm]	Bi [mm]
.05.	143400	142400	.05.12.C	50	.23.	143400	142400	.23.12.C	225
.06.	143400	142400	.06.12.C	68	.237.	143400	142400	.237.12.C	237
.07.	143400	142400	.07.12.C	75	.25.	143400	142400	.25.12.C	250
.087.	143400	142400	.087.12.C	87	.262.	143400	142400	.262.12.C	262
.10.	143400	142400	.10.12.C	100	.28.	143400	142400	.28.12.C	275
.11.	143400	142400	.11.12.C	108	.29.	143400	142400	.29.12.C	287
.112.	143400	142400	.112.12.C	112	.30.	143400	142400	.30.12.C	300
.12.	143400	142400	.12.12.C	125	.312.	143400	142400	.312.12.C	312
.137.	143400	142400	.137.12.C	137	.325.	143400	142400	.325.12.C	325
.15.	143400	142400	.15.12.C	150	.337.	143400	142400	.337.12.C	337
.162.	143400	142400	.162.12.C	162	.350.	143400	142400	.350.12.C	350
.17.	143400	142400	.17.12.C	168	.362.	143400	142400	.362.12.C	362
.18.	143400	142400	.18.12.C	175	.375.	143400	142400	.375.12.C	375
.187.	143400	142400	.187.12.C	187	.387.	143400	142400	.387.12.C	387
.20.	143400	142400	.20.12.C	200	.400.	143400	142400	.400.12.C	400
.212.	143400	142400	.212.12.C	212					

Full set, for both ends:

142400.05.12

Single-part order:

142400.05.1

Mounting bracket with pin

142400.05.2

Mounting bracket with bore



igus® Chainfix steel clamps and Chainfix stainless-steel clamps - max. pull forces, adjustable with hexagon socket. Available as single, double or triple clamps.

Details ► chapter 10

### Chainfix clamps for the C-profile

Part No. single clamps		Part No. double clamps		Part No. triple clamps		Cable
steel	stainless steel	steel	stainless steel	steel	stainless steel	ø [mm]
CFX12.1	CFX12.1.E	CFX12.2	CFX12.2.E	CFX12.3	-	06 - 12
CFX14.1	CFX14.1.E	CFX14.2	CFX14.2.E	CFX14.3	-	12 - 14
CFX16.1	CFX16.1.E	CFX16.2	CFX16.2.E	CFX16.3	-	14 - 16
CFX18.1	CFX18.1.E	CFX18.2	CFX18.2.E	CFX18.3	-	16 - 18
CFX20.1	CFX20.1.E	CFX20.2	CFX20.2.E	CFX20.3	-	18 - 20
CFX22.1	CFX22.1.E	CFX22.2	CFX22.2.E	CFX22.3	-	20 - 22
CFX26.1	CFX26.1.E	CFX26.2	CFX26.2.E	-	-	22 - 26
CFX30.1	CFX30.1.E	CFX30.2	CFX30.2.E	-	-	26 - 30
CFX34.1	CFX34.1.E	CFX34.2	CFX34.2.E	-	-	30 - 34
CFX38.1	CFX38.1.E	-	-	-	-	34 - 38
CFX42.1	CFX42.1.E	-	-	-	-	38 - 42



### Chainfix Clip - Modular snap-on strain relief device for C-profile

Available for all igus® E-ChainSystems® with C-profiles and also suitable for assembly in the KMA mounting brackets and clip-on strain relief for crossbars. High pull forces, plug-in modular snap-on strain relief device. Details ► chapter 10

Cable ø [mm]	Part No. clamp	Part No. bottom part
04 - 08	CFC-08-M	CFC-08-C
08 - 12	CFC-12-M	CFC-12-C
12 - 16	CFC-16-M	CFC-16-C
16 - 20	CFC-20-M	CFC-20-C
20 - 24	CFC-24-M	CFC-24-C



### Chainfix Nugget for the C-Profile

Strain relief for the fixation of cables up to a diameter of Ø 20 mm. Easy to assemble, without any screws and tools. Easy strain relief due to fixation with pre-hammered cable strap, very small space requirement.

Details ► chapter 10

Part No.	ø max. conduit [mm]	Width [mm]
CFN.20	20	10,8

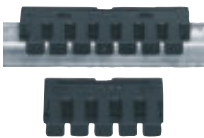

### Chainfix tiwrap plates with clip-on connection for the C-profile

Can be plugged into the KMA C-profile. Easy to assemble without any screws. Easily solvable with screwdriver nevertheless safe stop. For all E-Chains® with KMA and integrated C-profile. Details ► chapter 10

Part No.	Width of strain relief [mm]	Number of teeth
3050.ZC	50	5
3075.ZC	75	7

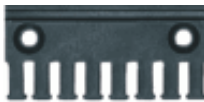

### Tiewrap plate as individual part

As individual component screwed on KMA. Can be plugged in the mounting brackets. Details ► chapter 10

Tiewrap plate	No. of teeth n	Dim. C [mm]	Dim. B [mm]	Center bore
3050.ZB	5	50	30	-
3075.ZB	7	75	55	-
3100.ZB	10	100	80	-
3115.ZB	11	115	95	-
3125.ZB	12	125	105	-
3150.ZB	15	150	130	-
3175.ZB	17	175	155	-
3200.ZB	20	200	180	+
3225.ZB	22	225	205	+
3250.ZB	25	250	230	+

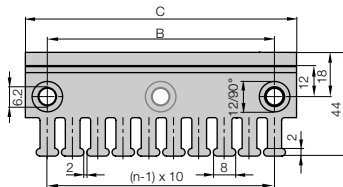
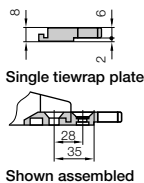

(- = no / + = yes)

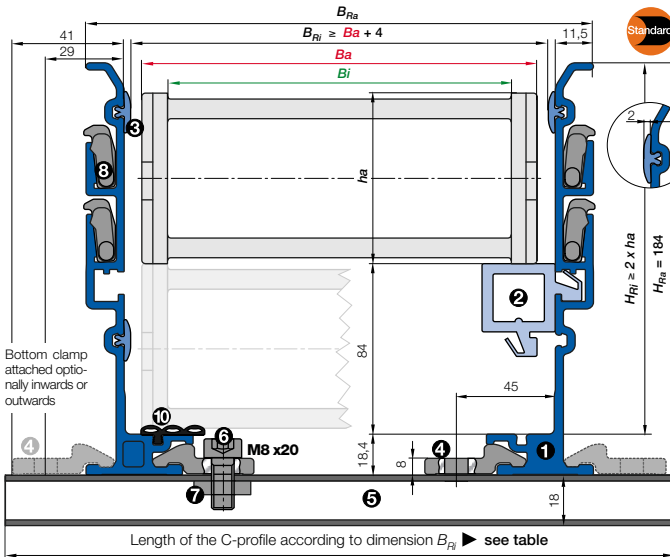

- $B_a$  = Outer width E-Chains\* / E-Tube
  - $B_i$  = Inner width E-Chains\* / E-Tube
  - $h_a$  = Outer height E-Chains\* / E-Tube
  - $H_{Ri}$  = Inner trough height
  - $H_{Ra}$  = Outer trough height
  - $B_{Ri}$  = Inner trough width ► depends on dim.  $B_a$
  - $B_{Ra}$  = Outer trough width
  - $n_{Mon}$  = Number of installation sets (left/right)
  - $\rho_{Ri}$  = Number of trough sets (left/right)
- $H_{Ri} \geq 2 \cdot h_a$   
 $B_{Ri} \geq B_a + 4$
- = Guide trough set
  - = Installation set "Basic"
  - = C-profile
  - = Glide bar

**Installation set "Basic" with C-profile**

Bottom Clamp attached optionally inwards or outwards ►

14240.05.200.0 ► Order example

$B_{Ri}$ [mm]	Part No. attached inwards	Part No. attached outwards
.05	80	960.50.200
.06	98	960.50.225
.07	105	960.50.225
.087	118	960.50.175
.10	130	960.50.200
.11	138	960.50.200
.112	143	960.50.200
.12	155	960.50.225
.137	168	960.50.225
.15	180	960.50.250
.162	193	960.50.250
.17	198	960.50.250
.18	205	960.50.275
.187	218	960.50.275
.20	230	960.50.300
.212	243	960.50.300
.23	255	960.50.325
.237	268	960.50.325
.25	280	960.50.350
.262	293	960.50.350
.28	305	960.50.375
.29	318	960.50.375
.30	330	960.50.400
.312	343	960.50.400
.325	355	960.50.425
.337	368	960.50.425
.350	380	960.50.450
.362	393	960.50.450
.375	405	960.50.475
.387	418	960.50.475
.400	430	960.50.500



- **Components, trough "Basic":** ① Trough side parts, aluminum, 2 m ② Glide bar, plastic, 2 m ③ Glide strips, plastic, 2 m (without glide strips on request) ⑩ Optional: Silencer profile, rubber
- **Components, installation set "Basic":** ④ Bottom clamp, aluminum ⑤ C-profile, steel galvanized ⑥ Screw M8 x20 ⑦ Sliding nut M8 ⑧ Interface connector, plastic



**Order example: Length of travel 30 m - Center mounted for Series 14240.10.200.0 with  $B_{Ri} = 130$**

Guide trough set (set of 2 trough side parts, incl. glide strips) <b>without</b> glide bar	Part No.	974.30.SL
Order text: 16 m guide trough without glide bar (8 x 2 m sections)		
Guide trough set (set of 2 trough side parts, incl. glide strips) <b>with</b> glide bar	Part No.	974.31.SL
Order text: 16 m guide trough with glide bar (8 x 2 m sections)		
Installation set "Basic" complete (guide trough-sets + 1)	Part No.	960.50.200
Order text: 17 installation sets "Basic"		
Module for the fixed end	Part No.	974.81
Order text: 1 set		
Option: For an additional noise dampening with silencer profile, please add Index A - Example:	Part No.	974.30.SLA

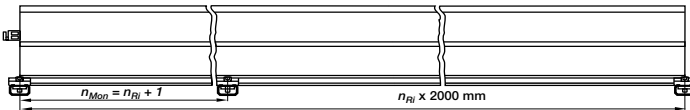

Principle sketch: Number of installation sets to be installed = **Number of trough sections + 1**



**NEW! A quick fix for mounting the stationary end of an E-Chain\***  
 With this new module for the fixed end, fast and easy mounting onto the Aluminum "SuperTrough" is now possible without any drilling. Fast mounting of the E-Chain\* by clamping onto the aluminum trough

- Quick relocation of the stationary end
- No drilling necessary ► page 9.16

Insert for the installation set "Heavy-Duty": **974.50.XXX** instead of (960.50.XXX) on the right column "attached outwards"



► Chapter 10



► Chapter 9



► page 7.161



Price index



**ESD classification:**  
Electrically conductive ESD/ATEX  
version upon request



**High torsional  
rigidity**



**Side-mounted -  
unsupported**



**Opening E-Chains®:** Remove crossbars and clips - Insert screwdriver into the slot, push down, release by lever action



**Remove lids/bottoms (E-Tubes) -** Insert screwdriver into the slot, release by lever action



**When to use the Series 15050/15150/R19850:**

- For achieving simple, economical solutions
- For minimizing a chain's external width at any given internal width
- For use if Series 5050 proves too large



**When not to use it:**

- If long side-mounted, unsupported length is required
- E4/4, Series 5050/5150/R9850, page 7.136

- 1 New stronger version with "tongue-and-groove-design"
- 2 High torsional rigidity
- 3 Crossbars are removable along both radii
- 4 Hinged snap-open removable lids along outer radius
- 5 Closed and open styles can be combined
- 6 Lateral glide surfaces for side-mounted operation
- 7 Numerous interior separation possibilities
- 8 Wide, rounded plastic crossbars - cable friendly
- 9 KMA mounting brackets with attachment points on all sides
- 10 Integrated strain relief possible

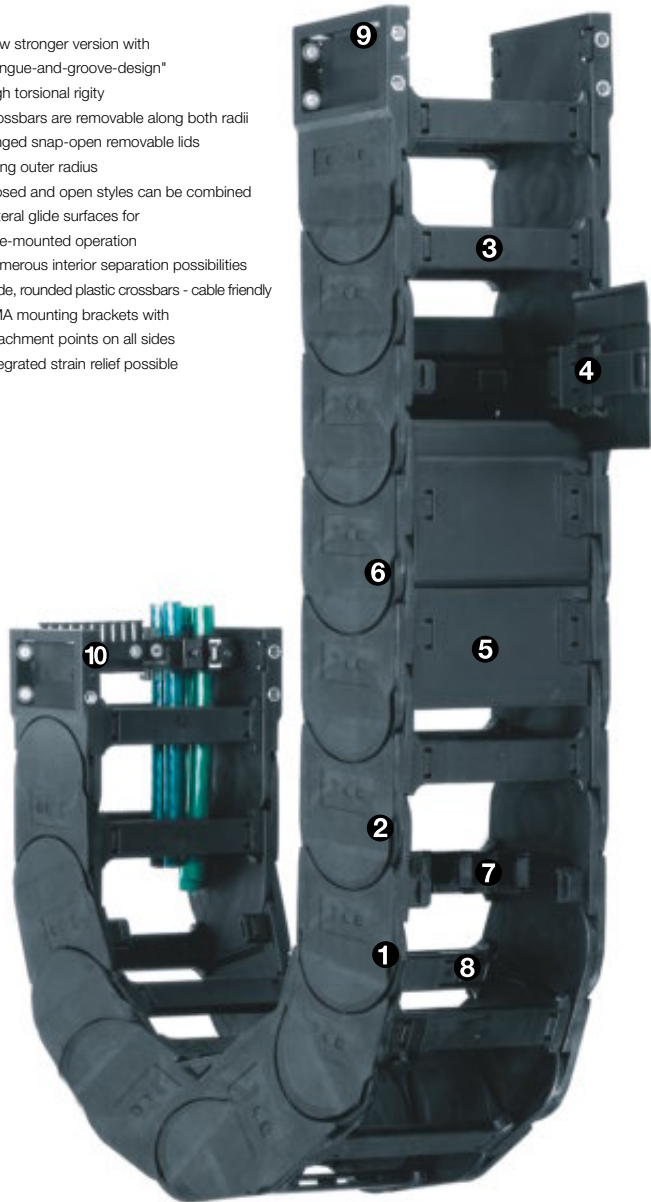

**Order example complete E-Chain®**

Please indicate chain-lengths or number of links **Example:** 5 m or 55 links

5 m **15050.30.300.0**

**E-Chain®**

with 2 separators **511** assembled every 2<sup>nd</sup> link

**Interior separation**

1 set **150500.30.12C**

**Mounting bracket**

**Unsupported length**

$FL_G$  = with straight upper run

$FL_B$  = with permitted sag

Further information ► **Design, page 1.12**

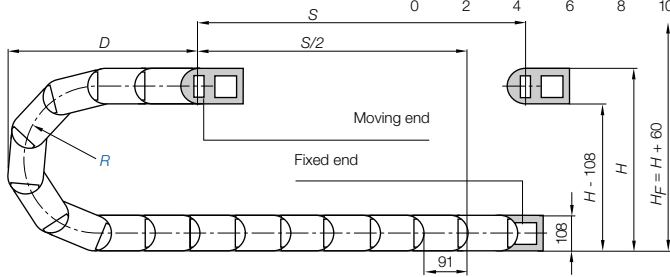
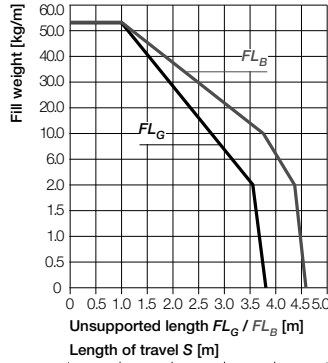
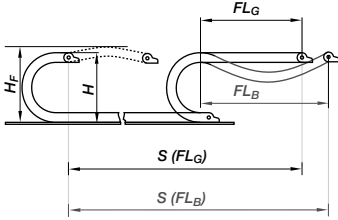

Pitch = 91 mm/link    Links/m = 11 (1001 mm)    Chain length =  $S/2 + K$

R	150	200	250	300	350	400	500
$H_{25}^{90}$	410	510	610	710	810	910	1110
D	300	350	400	450	500	550	650
K	750	900	1050	1225	1375	1450	1675
$D_2^{+25}$	550	800	950	1200	1550	1700	2175
$K_2$	910	1274	1638	2002	2457	2730	3458
$H_2$	424	424	424	424	424	424	424

- S = Length of travel
  - R = Radius
  - H = Nominal clearance height
  - $H_F$  = Required clearance height
  - $H_{in}$  = Trough inner height
  - D = Overlength E-Chain® radius in final position
  - K =  $\pi \cdot R$  + "safety"
  - $D_2$  = Over length - long travels, gliding
  - $K_2$  = "Further add-on"
  - $H_2$  = "Mounting height"
- \*if the mounting bracket location is set lower

**Other installation methods**

- Vertical, hanging  $\leq 100$  m
- Vertical, standing  $\leq 6$  m
- Side mounted, un supp.  $\leq 2$  m
- Rotary requires further calculation
- Unsupported length of upper run = upon request

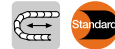

**Short travels - unsupported**

Unsupported E-Chains® feature positive camber over short travels. This must be accounted for when specifying the clearance height  $H_F$ . Please consult igus® if space is particularly restricted.

The required clearance height:  
 $H_F = H + 60$  mm  
(with 3,0 kg/m fill weight)

**Long travel lengths from 10 m to max. 250 m    Chain length =  $S/2 + K_2$**

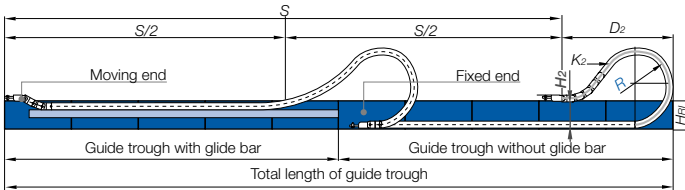

In case of travels between 4 and 10 m we recommend a longer unsupported length.



**Gliding, long travel applications (max. 250 m)**

In this case the E-Chain® upper run will be introduced in a guide trough on the lower run. We recommend to realize the engineering of such a plant by our technicians.

Speed / acceleration $FL_G$	max. 20 [m/s] / max. 200 [m/s <sup>2</sup> ]
Speed / acceleration $FL_B$	max. 3 [m/s] / max. 6 [m/s <sup>2</sup> ]
Gliding speed / acceleration (maximum)	max. 10 [m/s] / max. 50 [m/s <sup>2</sup> ]
Material - permitted temperature °C	igumid G / -40° up to +120° C
Flammability class, igumid G	VDE 0304 IIC UL94 HB

**Technical Data**



Details of material properties  
► page 1.38

80

System E4/light  
Inner height: 80 mm

Phone +49- (0) 22 03-96 49-800  
Fax +49- (0) 22 03-96 49-222



► page 7.161

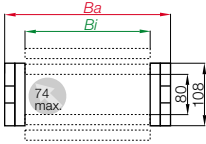

Part No. structure

15050.30.300.0



Series 15050 - E-Chain® with crossbars every link

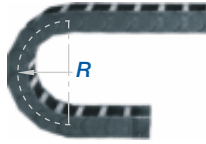

- Crossbars every link
- For rigid hydraulic hoses
- For applications particularly demanding
- Can be opened from two sides

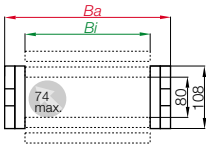

Part No. structure

15150.30.300.0



Series 15150 - E-Chain® with crossbars every 2<sup>nd</sup> link

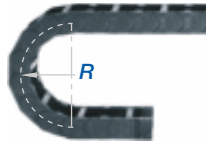

- Crossbars every 2<sup>nd</sup> link = Standard
- For nearly every situation
- Can be opened from two sides
- Easy assembly
- Stable
- Attractive price

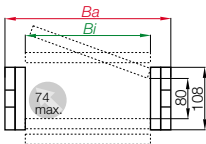

Part No. structure

19850.30.300.0



Series R19850 - Fully enclosed E-Tube

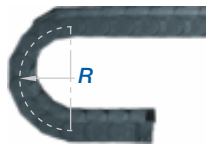

- Fully enclosed
- Excellent cable protection against dirt
- Protection against hot chips (up to 900°C)
- Lids along the entire inner radius are completely removable. Lids along the entire outer radius are single sided snap-open with a hinge on the other side to keep them attached to the chain or completely removable.



Part No.	<i>Bi</i> [mm]	<i>Ba</i> [mm]	15050 [kg/m]	15150 [kg/m]	R19850 [kg/m]	
15050/15150.05.	0	50	80	≈ 3,85	≈ 3,84	-
15050/15150/19850.07.	0*	75	105	≈ 4,00	≈ 3,92	≈ 4,46
15050/15150/19850.10.	0	100	130	≈ 4,18	≈ 4,00	≈ 4,74
15050/15150.11.	0	112	143	≈ 4,31	≈ 4,07	-
15050/15150/19850.12.	0	125	155	≈ 4,38	≈ 4,10	≈ 5,10
15050/15150.13.	0	137	168	≈ 4,51	≈ 4,17	-
15050/15150/19850.15.	0	150	180	≈ 4,58	≈ 4,20	≈ 5,53
15050/15150.16.	0	162	193	≈ 4,69	≈ 4,26	-
15050/15150.17.	0	175	205	≈ 4,80	≈ 4,31	-
15050/15150.18.	0	187	218	≈ 4,91	≈ 4,37	-
15050/15150/19850.20.	0	200	230	≈ 4,93	≈ 4,38	≈ 6,11
15050/15150.21.	0	212	243	≈ 5,04	≈ 4,43	-
15050/15150.22.	0	225	255	≈ 5,10	≈ 4,47	-
15050/15150.23.	0	237	268	≈ 5,24	≈ 4,53	-
15050/15150/19850.25.	0	250	280	≈ 5,32	≈ 4,58	≈ 6,83
15050/15150.26.	0	262	293	≈ 5,41	≈ 4,62	-
15050/15150/19850.27.	0	275	305	≈ 5,52	≈ 4,68	≈ 7,26
15050/15150.28.	0	287	318	≈ 5,54	≈ 4,69	-
15050/15150/19850.30.	0	300	330	≈ 5,76	≈ 4,80	≈ 7,49
15050/15150.31.	0	312	343	≈ 5,80	≈ 4,82	-
15050/15150.32.	0	325	355	≈ 5,85	≈ 4,84	-
15050/15150.33.	0	337	368	≈ 6,03	≈ 4,93	-
15050/15150/19850.35.	0	350	380	≈ 6,18	≈ 5,01	≈ 8,24
15050/15150.36.	0	362	393	≈ 6,19	≈ 5,02	-
15050/15150.37.	0	375	405	≈ 6,20	≈ 5,02	-
15050/15150.38.	0	387	418	≈ 6,29	≈ 5,06	-
15050/15150/19850.40.	0	400	430	≈ 6,49	≈ 5,16	≈ 9,20
15050/15150.41.	0	412	443	≈ 6,64	≈ 5,24	-
15050/15150.42.	0	425	455	≈ 6,80	≈ 5,31	-
15050/15150.43.	0	437	468	≈ 6,86	≈ 5,35	-
15050/15150.45.	0	450	480	≈ 6,93	≈ 5,38	-
15050/15150/19850.46.	0	462	493	≈ 6,95	≈ 5,39	≈ 9,66
15050/15150.47.	0	475	505	≈ 7,08	≈ 5,46	-
15050/15150.48.	0	487	518	≈ 7,16	≈ 5,49	-
15050/15150.50.	0	500	530	≈ 7,22	≈ 5,52	-
15050/15150.51.	0	512	543	≈ 7,24	≈ 5,53	-
15050/15150.52.	0	525	555	≈ 7,28	≈ 5,56	-
15050/15150.53.	0	537	568	≈ 7,44	≈ 5,63	-
15050/15150.55.	0	550	580	≈ 7,92	≈ 5,87	-
15050/15150.60.	0	600	630	≈ 8,12	≈ 5,97	-

Available bending radii

R [mm]

Supplement Part No. with required radius. Example: 15050.30. .0

0 = standard color, other colors ► page 1.39 · Pitch = 91 mm/link - Links/m = 11

\*not available for R19850

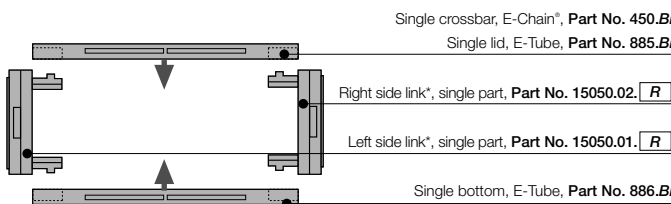

**TIP!**  
**Hot Chips up to 850°C**  
 E-Tubes that repel hot chips, up to 850 °C  
 Some applications, depending on amount and size of the chips, can burn or melt the surface. That is no longer the case with the new igus® "Iguimid HT" material.  
 Further information: [www.igus.de/en/HT](http://www.igus.de/en/HT) or phone: +49-0 22 03-96 49-800

System E4/light  
 Inner height: 80 mm

Phone +49- (0) 22 03-96 49-800  
 Fax +49- (0) 22 03-96 49-222



Extender crossbar for large diameter hoses ► page 7.188



**Part No. E-Chain® - links, single parts**

\*View from the fixed point of the E-Chain®/E-Tube



► page 7.161



**Option 1**

- Vertical separators
- Spacers
- Locking separators
- Asymmetric separators

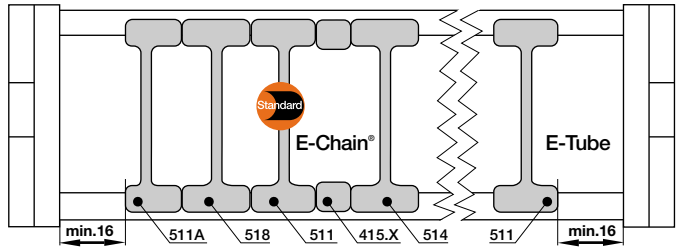

Vertical separator  
501

<b>Vertical separator for E-Chains®/E-Tubes</b>	
unassembled	501
assembled	511



**Option 1: Vertical separators and spacers**

Vertical separators are used if a vertical subdivision of the E-Chain® interior is required - By standard vertical separators are assembled every other E-Chain® link. **Note:** Observe a lateral spacing of at least 16 mm!

● **Standard separator 501 for E-Chains® and E-Tubes** offers safe stability due to its wide base design, also when used with thick cables or hoses.

● Vertical separators in side-mounted applications, for instance, can be fixed in position by means of **spacer 405.X for E-Chains®**. A wide range of intervals between the vertical separators is adjustable here.

● **Note on spacers:** The available interior height is reduced by 2 mm per spacer (4 mm when spacers are fitted on both sides). To avoid this, the parts can also be installed from the outside on the opening crossbar.



Spacer  
405.10

<b>Spacer* for E-Chains®</b>	
unassembled	405.10
assembled	415.10



Spacer  
405.15

<b>Spacer* for E-Chains®</b>	
unassembled	405.15
assembled	415.15



Spacer  
405.20

<b>Spacer* for E-Chains®</b>	
unassembled	405.20
assembled	415.20



Spacer  
405.30

<b>Spacer* for E-Chains®</b>	
unassembled	405.30
assembled	415.30



Spacer  
405.40

<b>Spacer* for E-Chains®</b>	
unassembled	405.40
assembled	415.40



**Additionally:**

● **Locking separator for E-Chains® 504-** with increased retention force for applications exposed to very high humidity or extreme loads. If locking separators are used, the E-Chain® is more difficult to open.

● The **Locking separator for E-Chains® 508** is designed for applications exposed to extremely high humidity, for example, at composting plants. The lateral cam serves for uniform alignment of the vertical separators; if these separators are misaligned, they will inevitably get damaged on an attempt to open the E-Chain®.



Locking separator  
504

<b>Locking separator for E-Chains®</b>	
unassembled	504
assembled	514



Locking separator  
508

<b>Locking separator for E-Chains®</b>	
unassembled	508
assembled	518



Asymmetric  
separator 501A

<b>Asymmetric separator* for E-Chains®</b>	
unassembled	501A
assembled	511A



\*For side-mounted applications

● **Asymmetric separator 501A for E-Chains®** (not for E-Tubes) with an 18-mm base, for combinations between spacers of different widths and vertical separators in side-mounted applications, for instance.

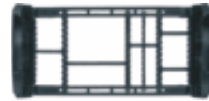
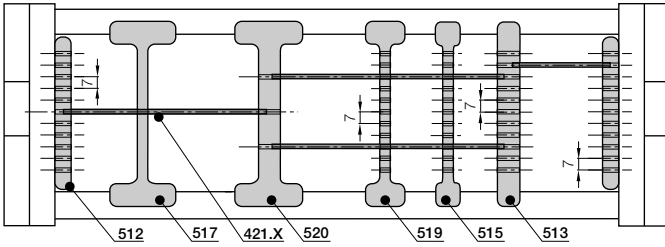

**Option 2**

- Side plates
- Middle plates
- Locking vertical separators
- Locking separators
- Slotted separators
- Open slotted separators

**Option 2: Shelves**

For applications involving many cables with different diameters. The shelves can be arranged elevator-shifted with different bottoms.

● Side plates 502, middle plates 503 and shelves 420.X form the basic pattern of a shelf system. Shelves of various widths can be arranged at 11 different heights (in 7 mm increments).

● Locking vertical separator 510 combined with shelves. Triple slots.

● Locking separator 507 slotted - with increased retention force for applications exposed to very high humidity or extreme loads. The extra retention force is achieved by asymmetric claws for the crossbar. Ensure proper alignment.

● Slotted separators 505 are used for very fine subdivisions. However, they cannot be retrofitted into an existing separation system without dismantling the interior separators first.

● The unilateral open slotted separator 509 can be retrofitted into an existing interior separation system without a need for dismantling the interior separators. During an installation of open slotted separators, the top and bottom notches cannot be occupied by shelves.

**Side plate for E-Chains®/E-Tubes**

unassembled	502
assembled	512

**Middle plate for E-Chains®/E-Tubes**

unassembled	503
assembled	513

**Locking vertical separator for E-Chains®/E-Tubes**

unassembled	510
assembled	520

**Locking separator for E-Chains®**

unassembled	507
assembled	517

**Slotted separator for E-Chains®/E-Tubes**

unassembled	505
assembled	515

**Open slotted separator for E-Chains®/E-Tubes**

unassembled	509
assembled	519

Width X [mm]	Part No. unassembled	Part No. assembled
18	420.18	421.18
23	420.23	421.23
25	420.25	421.25
28	420.28	421.28
33	420.33	421.33
43	420.43	421.43
50	420.50	421.50
62	420.62	421.62

Width X [mm]	Part No. unassembled	Part No. assembled
75	420.75	421.75
100	420.100	421.100
125	420.125	421.125
150	420.150	421.150
175	420.175	421.175
187	420.187	421.187
200	420.200	421.200

**Side plate 502**

**Middle plate 503**

**Locking vertical separator 510**

**Locking separator 507**

**Slotted separator 505**

**Open slotted separator 509**

**Shelf 420.X**

**Additional elements for interior separation**

Rollclip	unassembled	assembled
	489.27	490.27

**Rollclip** - minimizes abrasion of particularly sensitive hoses. The Rollclip is simply clamped onto the opening crossbar. The movable rollers compensate for relative movement between the chain and hose.



System E4/light  
Inner height: 80 mm

Phone +49- (0) 22 03-96 49-800  
Fax +49- (0) 22 03-96 49-222



▶ page 7.161



### Extension links - for extremely wide E-Chains® up to 3,0 m

- For applications in which particularly high fill weights necessitate extremely wide E-Chains® (up to 3000 mm)
- The extension link design allows virtually limitless side-by-side attachment of chains
- The unsupported length of a chain can be increased when additional loads are required
- Extension links can be used with E-Chains®, E-Tubes or as a combination of both
- They are suitable for unsupported and gliding applications in a guide trough
- E-Chains® with extension links are attached with KMA or steel mounting brackets



Part No. structure

15050.10 /20 /10. [200].0

15050.B11/B12/B13. [R].0

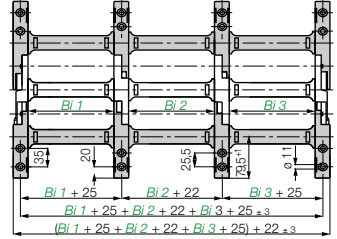

### Extender crossbars - careful guide of hoses applications

- Suitable for hoses with a maximum outer diameter of 300 mm
- Gliding operation with crossbars assembled along the outer radius and a special guide trough
- Gliding operation not guaranteed with crossbars assembled along the inner radius
- The extender crossbar can either be attached to the side links directly or can be used in combination with two stranded snap-open crossbars

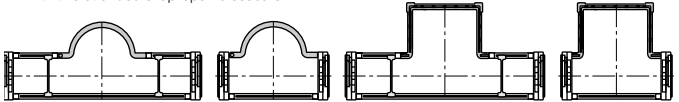

Consult igus® for your extender crossbar applications. We are happy to assist you with your design layout

Round extender crossbar with snap-open crossbars

Attached directly to the side link

Square extender crossbar with snap-open crossbars

Attached directly to the side link

Part No.	Max Ø [mm] hose	Form	Installation side link	Combination with snap-open crossb.
450.15.RHD115	115	○	-	+
450.17.RD115	115	○	+	-
450.25.D150	150	□	+	-
450.30.D200	200	□	+	-
450.35.D250	220	□	+	-
450.40.D300	270	□	+	-
450.20.HD150	150	□	-	+
450.25.HD200	200	□	-	+
450.30.HD250	280	□	-	+

○ = round □ = square + = yes / - = no



### E4 clip-on cable binder

- For side-mounted applications ● Serves as a clip-on, lateral guide for hoses and cables on E-Chains®
- The loops can be adjusted as required ● Compatible with many E4 E-Chains® ● Stylish and economical
- One clip and one locking band are needed for each chain link ● Call us if you have any questions on project planning

Part No.	Form
450.B12	Locking clip, comprising a locking element
450.B12.200	Locking band, comprising a locking element and band; 12 x 1,5 x 200 mm



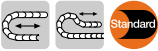

### The Standard - Option KMA\* - pivoting

- Recommended for unsupported and gliding applications
- Confined installation conditions
- Option - integrated C-profile strain relief device with Chainfix clip or strain relief tiwrap plates
- Corrosion resistant
- Universal mountable with attachment capability on all sides

\*KMA = Polymer Metal Mounting Bracket

Moving end

150500/198500...2

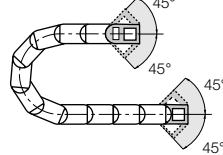

Fixed end

150500/198500...1



The attachment variants arising automatically by the choice of the KMA mounting bracket

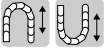
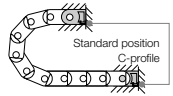

### Option KMA - locking

- Recommended for vertical hanging / standing applications

#### Additionally:

- Universal mountable
- C-profile option
- Corrosion resistant
- Locked connections
- At very high acceleration

Moving end

151500/199500...2

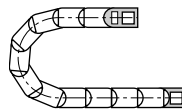

Fixed end

151500/199500...1



The attachment variants arising automatically by the choice of the KMA mounting bracket

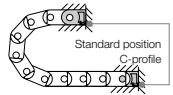

Fixed end  
150500/198500...1 (pivoting)  
151500/199500...1 (locking)

Moving end  
(pivoting) 150500/198500...2  
(locking) 151500/199500...2

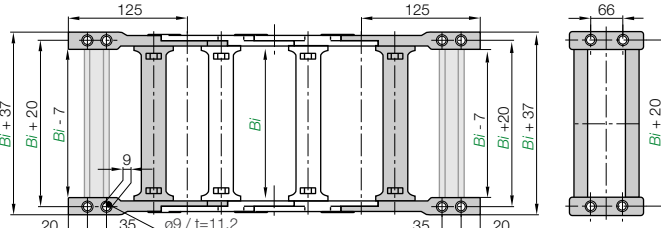

### Dimensions and order configurations

#### Part No. structure (pivoting)

150500	07.	12.	C
198500			

Optional with C-profile  
Full set  
Width  
150500 = E-Chain\*  
198500 = E-Tube\*

#### Part No. structure (locking)

151500	07.	12.	C
199500			

Optional with C-profile  
Full set  
Width  
151500 = E-Chain\*  
199500 = E-Tube\*

Width index	Part No. pivoting	Part No. locking	Full set	C-profile option [mm]	Bi	Width index	Part No. pivoting	Part No. locking	Full set	C-profile option [mm]	Bi
.05.	150500	151500		.05.12.□	50	.32.	150500	151500		.32.12.□	325
.07.	150500/198500	151500/199500		.07.12.□	75	.33.	150500	151500		.33.12.□	337
.10.	150500/198500	151500/199500		.10.12.□	100	.35.	150500/198500	151500/199500		.35.12.□	350
.11.	150500	151500		.11.12.□	112	.36.	150500	151500		.36.12.□	362
.12.	150500/198500	151500/199500		.12.12.□	125	.37.	150500	151500		.37.12.□	375
.13.	150500	151500		.13.12.□	137	.38.	150500	151500		.38.12.□	387
.15.	150500/198500	151500/199500		.15.12.□	150	.40.	150500/198500	151500/199500		.40.12.□	400
.16.	150500	151500		.16.12.□	162	.41.	150500	151500		.41.12.□	412
.17.	150500	151500		.17.12.□	175	.42.	150500	151500		.42.12.□	425
.18.	150500	151500		.18.12.□	187	.43.	150500	151500		.43.12.□	437
.20.	150500/198500	151500/199500		.20.12.□	200	.45.	150500	151500		.45.12.□	450
.21.	150500	151500		.21.12.□	212	.46.	150500/198500	151500/199500		.46.12.□	462
.22.	150500	151500		.22.12.□	225	.47.	150500	151500		.47.12.□	475
.23.	150500	151500		.23.12.□	237	.48.	150500	151500		.48.12.□	487
.25.	150500/198500	151500/199500		.25.12.□	250	.50.	150500	151500		.50.12.□	500
.26.	150500	151500		.26.12.□	262	.51.	150500	151500		.51.12.□	512
.27.	150500/198500	151500/199500		.27.12.□	275	.52.	150500	151500		.52.12.□	525
.28.	150500	151500		.28.12.□	287	.53.	150500	151500		.53.12.□	537
.30.	150500/198500	151500/199500		.30.12.□	300	.55.	150500	151500		.55.12.□	550
.31.	150500	151500		.31.12.□	312	.60.	150500	151500		.60.12.□	600

Full set, for both ends:

151500. 05. 12

Single-part order:

151500. 05. 1

Mounting bracket with pin

151500. 05. 2

Mounting bracket with bore



**Option steel - pivoting**

- For pivoting connections
- One part (two-piece) for all chain widths
- Electrically conductive

Moving end  
15050.1

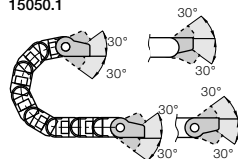

Fixed end  
15050.2

Possible installation conditions -

Further installation angles ► installation sketch

Phone +49- (0) 22 03-96 49-800  
Fax +49- (0) 22 03-96 49-222

igus® GmbH  
51147 Cologne

Internet: [www.igus.de](http://www.igus.de)  
E-mail: [info@igus.de](mailto:info@igus.de)

Moving end  
15050.1

Fixed end  
15050.2

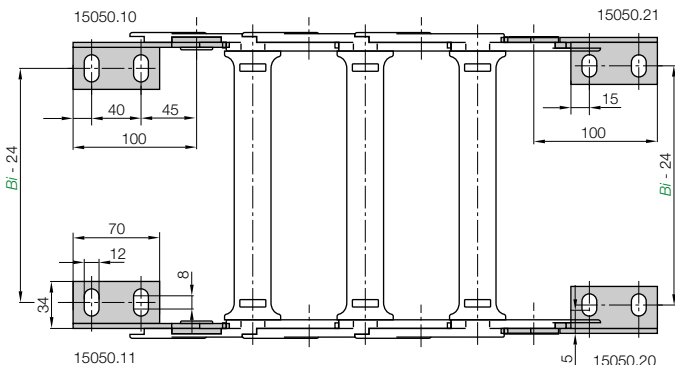

For E-Chain®	Part No. full set	Bi (mm)	For E-Chain®	Part No. full set	Bi (mm)
15050-15150.05	► 15050.12	50	15050-15150.32	► 15050.12	325
15050-15150-19850.07	► 15050.12	75	15050-15150.33	► 15050.12	337
15050-15150-19850.10	► 15050.12	100	15050-15150-19850.35	► 15050.12	350
15050-15150.11	► 15050.12	112	15050-15150.36	► 15050.12	362
15050-15150-19850.12	► 15050.12	125	15050-15150.37	► 15050.12	375
15050-15150.13	► 15050.12	137	15050-15150.38	► 15050.12	387
15050-15150-19850.15	► 15050.12	150	15050-15150-19850.40	► 15050.12	400
15050-15150.16	► 15050.12	162	15050-15150.41	► 15050.12	412
15050-15150.17	► 15050.12	175	15050-15150.42	► 15050.12	425
15050-15150.18	► 15050.12	187	15050-15150.43	► 15050.12	437
15050-15150-19850.20	► 15050.12	200	15050-15150.45	► 15050.12	450
15050-15150.21	► 15050.12	212	15050-15150-19850.46	► 15050.12	462
15050-15150.22	► 15050.12	225	15050-15150.47	► 15050.12	475
15050-15150.23	► 15050.12	237	15050-15150.48	► 15050.12	487
15050-15150-19850.25	► 15050.12	250	15050-15150.50	► 15050.12	500
15050-15150.26	► 15050.12	262	15050-15150.51	► 15050.12	512
15050-15150-19850.27	► 15050.12	275	15050-15150.52	► 15050.12	525
15050-15150.28	► 15050.12	287	15050-15150.53	► 15050.12	537
15050-15150-19850.30	► 15050.12	300	15050-15150.55	► 15050.12	550
15050-15150.31	► 15050.12	312	15050-15150.60	► 15050.12	600

15050.12 Full set, 4 parts

2 with pin / 2 with bore

Single-part order:

15050.1 Mounting bracket with bore, 1 part left / right

15050.2 Mounting bracket with pin, 1 part left / right

Other strain relief elements

► chapter 10

### Chainfix clamps for the C-profile

Part No. single clamps		Part No. double clamps		Part No. triple clamps		Cable
steel	stainless steel	steel	stainless steel	steel	stainless steel	ø [mm]
CFX12.1	CFX12.1.E	CFX12.2	CFX12.2.E	CFX12.3	-	06 - 12
CFX14.1	CFX14.1.E	CFX14.2	CFX14.2.E	CFX14.3	-	12 - 14
CFX16.1	CFX16.1.E	CFX16.2	CFX16.2.E	CFX16.3	-	14 - 16
CFX18.1	CFX18.1.E	CFX18.2	CFX18.2.E	CFX18.3	-	16 - 18
CFX20.1	CFX20.1.E	CFX20.2	CFX20.2.E	CFX20.3	-	18 - 20
CFX22.1	CFX22.1.E	CFX22.2	CFX22.2.E	CFX22.3	-	20 - 22
CFX26.1	CFX26.1.E	CFX26.2	CFX26.2.E	-	-	22 - 26
CFX30.1	CFX30.1.E	CFX30.2	CFX30.2.E	-	-	26 - 30
CFX34.1	CFX34.1.E	CFX34.2	CFX34.2.E	-	-	30 - 34
CFX38.1	CFX38.1.E	-	-	-	-	34 - 38
CFX42.1	CFX42.1.E	-	-	-	-	38 - 42



igus® Chainfix steel clamps and Chainfix stainless-steel clamps - max. pull forces, adjustable with hexagon socket. Available as single, double or triple clamps.

Details ► chapter 10

System E4/light  
Inner height: 80 mm

Cable ø [mm]	Part No. clamp	Part No. bottom part
04 - 08	CFC-08-M	CFC-08-C
08 - 12	CFC-12-M	CFC-12-C
12 - 16	CFC-16-M	CFC-16-C
16 - 20	CFC-20-M	CFC-20-C
20 - 24	CFC-24-M	CFC-24-C

### Chainfix Clip - Modular snap-on strain relief device for C-profile

Available for all igus® E-ChainSystems® with C-profiles and also suitable for assembly in the KMA mounting brackets and clip-on strain relief for crossbars. High pull forces, plug-in modular snap-on strain relief device. Details ► chapter 10



Part No.	ø max.	Width
	conduit [mm]	[mm]
CFN.20	20	10,8

### Chainfix Nugget for the C-Profile

Strain relief for the fixation of cables up to a diameter of Ø 20 mm. Easy to assemble, without any screws and tools. Easy strain relief due to fixation with pre-harnessed cable strap, very small space requirement. Details ► chapter 10



Part No.	Width of	Number of teeth
	strain relief [mm]	
3050.ZC	50	5
3075.ZC	75	7

### Chainfix tiwrap plates with clip-on connection for the C-profile

Can be plugged into the KMA C-profile. Easy to assemble without any screws. Easily solvable with screwdriver nevertheless safe stop. For all E-Chains® with KMA and integrated C-profile. Details ► chapter 10

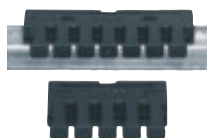

Tiewrap plate	No. of teeth n	Dim. C [mm]	Dim. B [mm]	Center bore
3050.ZB	5	50	30	-
3075.ZB	7	75	55	-
3100.ZB	10	100	80	-
3115.ZB	11	115	95	-
3125.ZB	12	125	105	-
3150.ZB	15	150	130	-
3175.ZB	17	175	155	-
3200.ZB	20	200	180	+
3225.ZB	22	225	205	+
3250.ZB	25	250	230	+

(- = no / + = yes)

### Tiewrap plate as individual part

As individual component screwed on KMA. Can be plugged in the mounting brackets. Details ► chapter 10

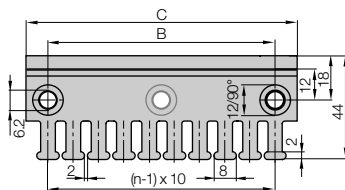

Single tiewrap plate

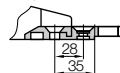

Shown assembled

Phone +49- (0) 22 03-96 49-800  
Fax +49- (0) 22 03-96 49-222



► Chapter 10



► page 7.91

- $B_a$  = Outer width E-Chains® / E-Tube
- $B_i$  = Inner width E-Chains® / E-Tube
- $h_a$  = Outer height E-Chains® / E-Tube
- $H_{Ri}$  = Inner trough height
- $H_{Ra}$  = Outer trough height
- $B_{Ri}$  = Inner trough width ► depends on dim.  $B_a$
- $B_{Ra}$  = Outer trough width
- $n_{Mon}$  = Number of installation sets (left/right)
- $n_{Ri}$  = Number of troughs sets (left/right)
- $H_{Ri} \geq 2 \cdot h_a$
- $B_{Ri} \geq B_a + 4$
- = Guide trough set    ● = Glide bar
- = Installation set "Basic"    ● = C-profile

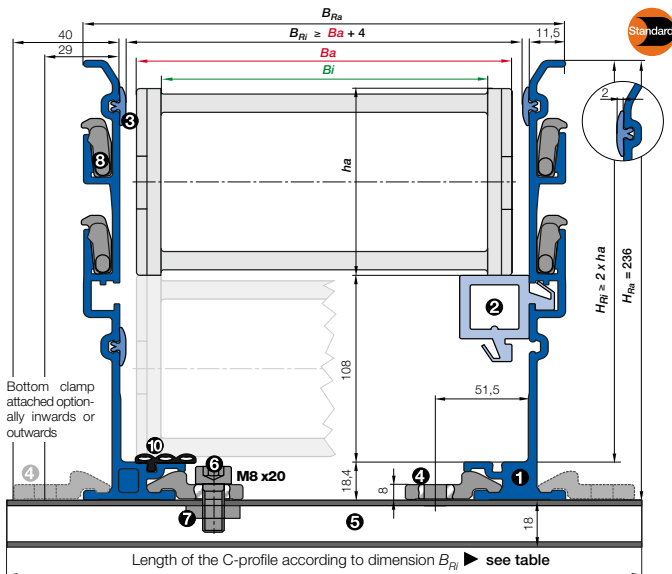

### Installation set "Basic" with C-profile

Bottom Clamp attached optionally inwards or outwards

15050.30.300.0 ► Order example

Part No.	Part No.	
	$B_{Ri}$ attached	attached
	[mm] inwards	outwards
.05	84	960.50.200
.07	109	960.50.225
.10	134	960.50.250
.11	146	960.50.200
.12	159	960.50.225
.13	171	960.50.225
.15	184	960.50.250
.16	196	960.50.250
.17	209	960.50.275
.18	221	960.50.275
.20	234	960.50.300
.21	246	960.50.300
.22	259	960.50.325
.23	271	960.50.325
.25	284	960.50.350
.26	296	960.50.350
.27	309	960.50.375
.28	321	960.50.375
.30	334	960.50.400
.31	346	960.50.400
.32	359	960.50.425
.33	371	960.50.425
.35	384	960.50.450
.36	396	960.50.450
.37	409	960.50.475
.38	421	960.50.475
.40	434	960.50.500
.41	446	960.50.500
.42	459	960.50.525
.43	471	960.50.525
.45	484	960.50.550
.46	496	960.50.550
.47	509	960.50.575
.48	521	960.50.575
.50	534	960.50.600
.51	546	960.50.600
.52	559	960.50.625
.53	571	960.50.625
.55	584	960.50.650
.60	634	960.50.700



- Components, trough "Basic": ① Trough side parts, aluminum, 2 m ② Glide bar, plastic, 2 m ③ Glide strips, plastic, 2 m (without glide strips on request) ⑩ Optional: Silencer profile, rubber
- Components, installation set "Basic": ④ Bottom clamp, aluminum ⑤ C-profile, steel galvanized ⑥ Screw M8 x20 ⑦ Sliding nut M8 ⑧ Interface connector, plastic



Order example: Length of travel 30 m - Center mounted for Series 15050.30.300.0 with  $B_{Ri} = 334$

Guide trough set (set of 2 trough side parts, incl. glide strips) <b>without</b> glide bar	Part No.	975.30.SL
Order text: 16 m guide trough without glide bar (8 x 2 m sections)		
Guide trough set (set of 2 trough side parts, incl. glide strips) <b>with</b> glide bar	Part No.	975.31.SL
Order text: 16 m guide trough with glide bar (8 x 2 m sections)		
Installation set "Basic" complete (guide trough-sets + 1)	Part No.	960.50.400
Order text: 17 installation sets "Basic"		
Module for the fixed end	Part No.	975.80
Order text: 1 set		
Option: For an additional noise dampening with silencer profile, please add Index A - Example:	Part No.	975.30.SLA

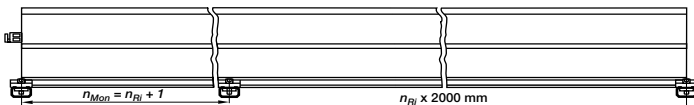

Principle sketch: Number of installation sets to be installed = Number of trough sections + 1

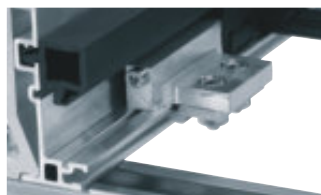

### NEW! A quick fix for mounting the stationary end of an E-Chain®

With this new module for the fixed end, fast and easy mounting onto the Aluminum "SuperTrough" is now possible without any drilling. Fast mounting of the E-Chain® by clamping onto the aluminum trough ● Quick relocation of the stationary end ● No drilling necessary ► page 9.16

Insert for the installation set "Heavy-Duty": **974.50.XXX** instead of (960.50.XXX) on the right column "attached outwards"

Phone +49- (0) 22 03-96 49-800  
Fax +49- (0) 22 03-96 49-222

igus® GmbH  
51147 Cologne

Internet: www.igus.de  
E-mail: info@igus.de



System E4/light  
Inner height: 80 mm

Phone +49- (0) 22 03-96 49-800  
Fax +49- (0) 22 03-96 49-222



▶ Chapter 9



▶ page 7.161

## TPE Bus cables for maximum load requirement - Chainflex® CFBUS

TIP!

TPE outer jacket, shielded, oil-resistant, bio-oil-resistant, flame-retardant  
Further information: [www.igus.de/en/CFBUS](http://www.igus.de/en/CFBUS)

CHAINFLEX® CFBUS



Price index



Series 1640

Series R1608



ESD classification:

Electrically conductive ESD/ATEX version upon request



High torsional rigidity



Side-mounted - unsupported



Opening E-Chains®: Remove crossbars and clips - Insert screwdriver into the slot, push down, release by lever action



Remove lids/bottoms (E-Tubes) - Insert screwdriver into the slot, release by lever action



When to use the Series 1640/R1608:

- For achieving simple, economical solutions
- For minimizing a chain's external width at any given internal width
- For use if Series 640 proves too large



When not to use it:

- If maximum stability is required  
▶ Series 600/R608, page 7.56

- 1 Numerous interior separation possibilities
- 2 Wide, rounded plastic crossbars - cable friendly
- 3 Lateral glide surfaces for side-mounted operation
- 4 Closed and open styles can be combined
- 5 Hinged snap-open removable lids along outer radius
- 6 Removable lids along inner radius
- 7 Dirt-repellent exterior
- 8 E-Chains® also available with reverse bending radius "RBR"



Order example complete E-Chain®

Please indicate chain-lengths or number of links **Example: 2 m or 14 links**

2 m 1640.30.300.0



E-Chain®

with 2 separators 6411 assembled every 2<sup>nd</sup> link



Interior separation

1 set 16000.1.12



Mounting bracket

**Unsupported length**

$FL_G$  = with straight upper run  
 $FL_B$  = with permitted sag  
 Further information ► **Design, page 1.12**

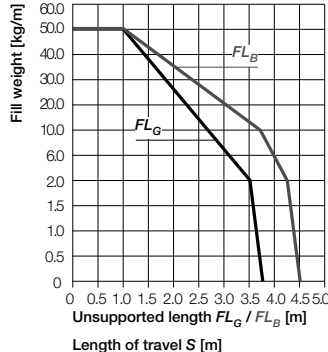
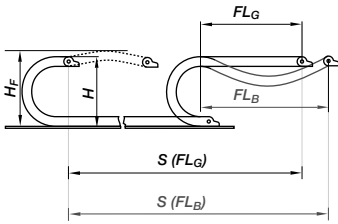

- $S$  = Length of travel
  - $R$  = Bending radius
  - $H$  = Nominal clearance height
  - $H_F$  = Required clearance height
  - $H_{in}$  = Trough inner height
  - $D$  = Overlength E-Chain® radius in final position
  - $K = \pi \cdot R + \text{"safety"}$
  - $D_2$  = Over length - long travels, gliding
  - $K_2$  = "Further add-on"
  - $H_2$  = "Mounting height"
- \*if the mounting bracket location is set lower

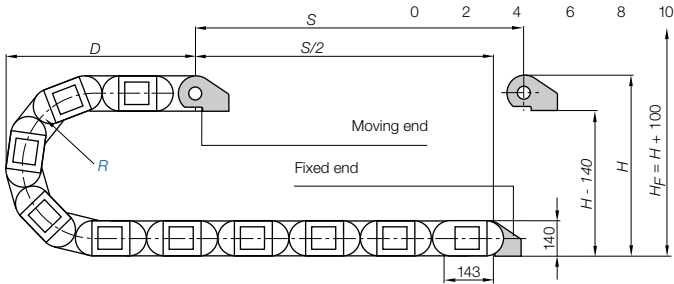

Pitch = 143 mm/link    Links/m = 7 (1001 mm)    Chain length =  $S/2 + K$

	200	250	300	350	400	450	500	550	600
$H$	545	645	747	845	945	1045	1145	1245	1345
$D$	415	465	515	565	615	665	715	765	815
$K$	920	1080	1240	1400	1560	1720	1870	2020	2175
$D_2^{+25}$	-	-	350	380	490	530	665	730	935
$K_2$	-	-	1859	2288	2574	3120	3289	3701	3861
$H_2$	325	325	325	325	325	325	325	325	325

**Other installation methods**

- Vertical, hanging  $\leq 100$  m
- Vertical, standing  $\leq 5$  m
- Side mounted, un supp.  $\leq 2$  m
- Rotary requires further calculation
- Unsupported length of upper run = upon request

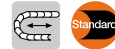

**Short travels - unsupported**

Unsupported E-Chains® feature positive camber over short travels. This must be accounted for when specifying the clearance height  $H_F$ . Please consult igus® if space is particularly restricted.

The required clearance height:  
 $H_F = H + 100$  mm  
 (with 5,0 kg/m fill weight)

**Long travel lengths from 10 m to max. 400 m**    Chain length =  $S/2 + K_2$

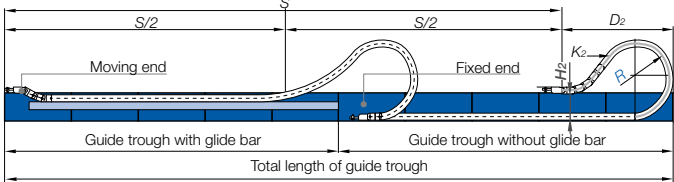

In case of travels between 4 and 10 m we recommend a longer unsupported length.



**Gliding, long travel applications (max. 400 m)**

In this case the E-Chain® upper run will be introduced in a guide trough on the lower run. We recommend to realize the engineering of such a plant by our technicians.

Speed / acceleration $FL_G$	max. 20 [m/s] / max. 200 [m/s <sup>2</sup> ]
Speed / acceleration $FL_B$	max. 3 [m/s] / max. 6 [m/s <sup>2</sup> ]
Gliding speed / acceleration (maximum)	max. 10 [m/s] / max. 50 [m/s <sup>2</sup> ]
Material - permitted temperature °C	igumid G / -40° up to +120° C
Flammability class, igumid G	VDE 0304 IIC UL94 HB

**Technical Data**



Details of material properties  
 ► page 1.38

112

System E4/light  
 Inner height: 112 mm

Phone +49- (0) 22 03-96 49-800  
 Fax +49- (0) 22 03-96 49-222



► page 7.161



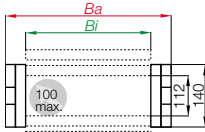

Part No. structure

1640. 30. 300. 0



Series 1640 - E-Chain® with crossbars every link

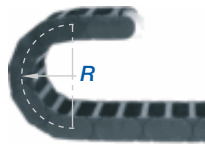

- Crossbars every link
- For rigid hydraulic hoses
- For applications particularly demanding
- Can be opened from two sides

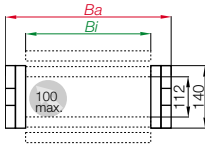

Part No. structure

1608. 30. 300. 0



Series R1608 - Fully enclosed E-Tube

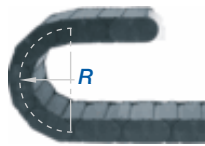

- Crossbars every 2<sup>nd</sup> link = Standard
- For nearly every situation
- Can be opened from two sides
- Easy assembly
- Stable
- Attractive price



Unsupported, harnesses  
Series 1640 in a stone  
machining application



Part No.		Bi [mm]	Ba [mm]	1640 [kg/m]	R1608 [kg/m]
1640.05.....	<input type="checkbox"/> .0	50	84	≈ 5,10	-
1640.06.....	<input type="checkbox"/> .0	65	99	≈ 5,18	-
1640.07.....	<input type="checkbox"/> .0	75	109	≈ 5,27	-
1640.10.....	<input type="checkbox"/> .0	100	134	≈ 5,36	-
1640.11.....	<input type="checkbox"/> .0	112	146	≈ 5,45	-
1640.12.....	<input type="checkbox"/> .0	125	159	≈ 5,54	-
1640.13.....	<input type="checkbox"/> .0	137	171	≈ 5,63	-
1640.15.....	<input type="checkbox"/> .0	150	184	≈ 5,67	-
1640.16.....	<input type="checkbox"/> .0	162	196	≈ 5,74	-
1640.17.....	<input type="checkbox"/> .0	175	209	≈ 5,81	-
1640.18.....	<input type="checkbox"/> .0	187	221	≈ 5,88	-
1640/1608.20.....	<input type="checkbox"/> .0	200	234	≈ 5,89	upon request
1640.21.....	<input type="checkbox"/> .0	212	246	≈ 5,96	-
1640.22.....	<input type="checkbox"/> .0	225	259	≈ 6,01	-
1640.23.....	<input type="checkbox"/> .0	237	271	≈ 6,09	-
1640/1608.25.....	<input type="checkbox"/> .0	250	284	≈ 6,15	upon request
1640.26.....	<input type="checkbox"/> .0	262	296	≈ 6,20	-
1640.27.....	<input type="checkbox"/> .0	275	309	≈ 6,27	-
1640.28.....	<input type="checkbox"/> .0	287	321	≈ 6,29	-
1640/1608.30.....	<input type="checkbox"/> .0	300	334	≈ 6,34	upon request
1640.31.....	<input type="checkbox"/> .0	312	346	≈ 6,41	-
1640.32.....	<input type="checkbox"/> .0	325	359	≈ 6,48	-
1640.33.....	<input type="checkbox"/> .0	337	371	≈ 6,59	-
1640/1608.35.....	<input type="checkbox"/> .0	350	384	≈ 6,61	upon request
1640.36.....	<input type="checkbox"/> .0	362	396	≈ 6,67	-
1640.37.....	<input type="checkbox"/> .0	375	409	≈ 6,71	-
1640.38.....	<input type="checkbox"/> .0	387	421	≈ 6,76	-
1640/1608.40.....	<input type="checkbox"/> .0	400	434	≈ 6,89	upon request
1640.41.....	<input type="checkbox"/> .0	412	446	≈ 6,99	-
1640.42.....	<input type="checkbox"/> .0	425	459	≈ 7,08	-
1640.43.....	<input type="checkbox"/> .0	437	471	≈ 7,13	-
1640.45.....	<input type="checkbox"/> .0	450	484	≈ 7,17	-
1640.46.....	<input type="checkbox"/> .0	462	496	≈ 7,18	-
1640.47.....	<input type="checkbox"/> .0	475	509	≈ 7,22	-
1640.48.....	<input type="checkbox"/> .0	487	521	≈ 7,27	-
1640.50.....	<input type="checkbox"/> .0	500	534	≈ 7,35	-
1640.51.....	<input type="checkbox"/> .0	512	546	≈ 7,36	-
1640.52.....	<input type="checkbox"/> .0	525	559	≈ 7,39	-
1640.53.....	<input type="checkbox"/> .0	537	571	≈ 7,49	-
1640.55.....	<input type="checkbox"/> .0	550	584	≈ 7,80	-
1640.60.....	<input type="checkbox"/> .0	600	634	≈ 7,92	-

Available bending radii

R [mm] 200\* 250 300 350 400 450 500 550 600

Supplement Part No. with required radius. Example: 1640.30.300.0

0 = standard color, other colors ▶ page 1.39 · Pitch = 143 mm/link - Links/m = 7

\*not available for R1608

**TIP!**

## Hot Chips up to 850°C

E-Tubes that repel hot chips, up to 850 °C  
Some applications, depending on amount and size of the chips, can burn or melt the surface. That is no longer the case with the new igus® "igumid HT" material.

Further information:  
[www.igus.de/en/HT](http://www.igus.de/en/HT)  
or phone:  
+49-0 22 03-96 49-800



Extender crossbar for large diameter hoses ▶ page 7.200

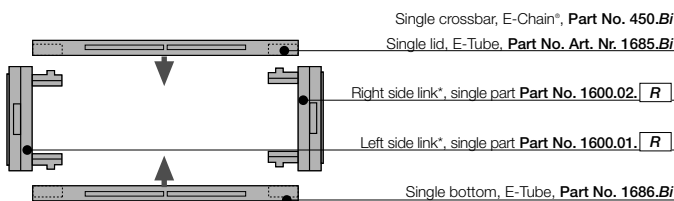

### Part No. E-Chain® - links, single parts

\*View from the fixed point of the E-Chain®/E-Tube

System E4/light  
Inner height: 112 mm

Phone +49- (0) 22 03-96 49-800  
Fax +49- (0) 22 03-96 49-222



▶ page 7.161

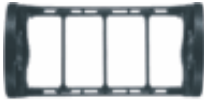

**Option 1**

- Vertical separators
- Spacers
- Locking separators

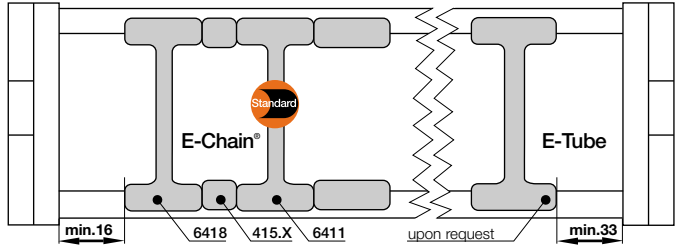

Vertical separator  
6401



Spacer  
405.10



Spacer  
405.15



Spacer  
405.20



Spacer  
405.30



Spacer  
405.40



Locking separator  
6408

Vertical separator for E-Chains®	
unassembled	6401
assembled	6411



Spacer* for E-Chains®	
unassembled	405.10
assembled	415.10



Spacer* for E-Chains®	
unassembled	405.15
assembled	415.15



Spacer* for E-Chains®	
unassembled	405.20
assembled	415.20



Spacer* for E-Chains®	
unassembled	405.30
assembled	415.30



Spacer* for E-Chains®	
unassembled	405.40
assembled	415.40



Locking separator for E-Chains®	
unassembled	6408
assembled	6418



\*For side-mounted applications

**Option 1: Vertical separators and spacers**

Vertical separators are used if a vertical subdivision of the E-Chain® interior is required - By standard vertical separators are assembled every other E-Chain® link. **Note:** Observe a lateral spacing of at least 16 mm for E-Chains® and at least 33 mm for E-Tubes!

● **Standard separator 6401 for E-Chains®** offers safe stability due to its wide base design, also when used with thick cables or hoses.

● Vertical separators in side-mounted applications, for instance, can be fixed in position by means of **spacer 405.X for E-Chains®**. A wide range of intervals between the vertical separators is adjustable here.

● **Note on spacers:** The available interior height is reduced by 2 mm per spacer (4 mm when spacers are fitted on both sides). To avoid this, the parts can also be installed from the outside on the opening crossbar.

**Additionally:**

● **Locking separator 6408 for E-Chains®** - with increased retention force for applications exposed to very high humidity or extreme loads. The extra retention force is achieved by asymmetric claws for the crossbar. Ensure proper alignment.

● **Vertical separator for E-Tubes R1608 upon request**

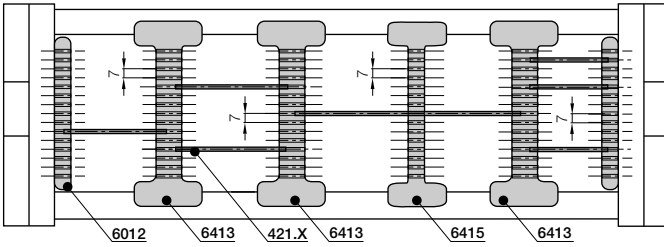

**Option 2**

- Side plates
- Middle plates
- Open slotted separators

**Option 2: Shelves**

For applications involving many cables with different diameters. The shelves can be arranged elevator-shifted with different bottoms.

● Side plates 6002, middle plates 6403 (not for E-Tubes) and shelves 420.X form the basic pattern of a shelf system. Shelves of various widths can be arranged at 15 different heights (in 7 mm increments).

● Slotted separators 6405 are used for very fine subdivisions. However, they cannot be retrofitted into an existing separation system without dismantling the interior separators first.

Side plate for E-Chains®/E-Tubes
unassembled 6002
assembled 6012

Middle plate for E-Chains®/E-Tubes
unassembled 6403
assembled 6413

Open slotted separator for E-Chains®/E-Tubes
unassembled 6405
assembled 6415

Side plate 6002
-----------------

Middle plate 6403
-------------------

Slotted separator open 6405
-----------------------------

Width X [mm]	Part No. unassembled	Part No. assembled
18	420.18	421.18
23	420.23	421.23
25	420.25	421.25
28	420.28	421.28
33	420.33	421.33
43	420.43	421.43
50	420.50	421.50
62	420.62	421.62

Width X [mm]	Part No. unassembled	Part No. assembled
75	420.75	421.75
100	420.100	421.100
125	420.125	421.125
150	420.150	421.150
175	420.175	421.175
187	420.187	421.187
200	420.200	421.200



Shelf 420.X

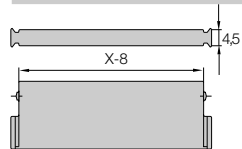

**Additional elements for interior separation**

<b>Rollclip</b>
unassembled 489.27
assembled 490.27

**Rollclip** - minimizes abrasion of particularly sensitive hoses. The Rollclip is simply clamped onto the opening crossbar. The movable rollers compensate for relative movement between the chain and hose.

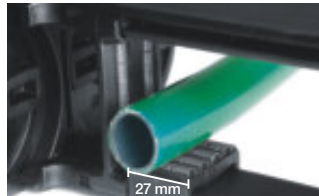

System E4/light  
Inner height: 112 mm

Phone +49- (0) 22 03-96 49-800  
Fax +49- (0) 22 03-96 49-222





### Extension links - for extremely wide E-Chains® up to 3,0 m

- For applications in which particularly high fill weights necessitate extremely wide E-Chains® (up to 3000 mm)
- The extension link design allows virtually limitless side-by-side attachment of chains
- The unsupported length of a chain can be increased when additional loads are required
- Extension links can be used with E-Chains®, E-Tubes or as a combination of both
- They are suitable for unsupported and gliding applications in a guide trough
- E-Chains® with extension links are attached with KMA or steel mounting brackets



Part No. structure  
1640.10 /20 /10. 200.0  
1640.Bi1/Bi2/Bi3. R 1.0

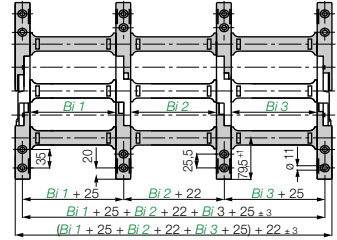

### Extender crossbars - careful guide of hoses applications

- Suitable for hoses with a maximum outer diameter of 300 mm
- Gliding operation with crossbars assembled along the outer radius and a special guide trough
- Gliding operation not guaranteed with crossbars assembled along the inner radius
- The extender crossbar can either be attached to the side links directly or can be used in combination with two stranded snap-open crossbars

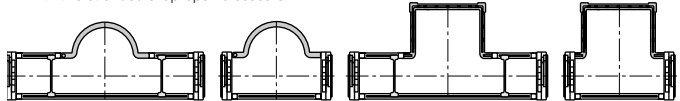

Consult igus® for your extender crossbar applications. We are happy to assist you with your design layout

Round extender crossbar with snap-open crossbars

Attached directly to the side link

Square extender crossbar with snap-open crossbars

Attached directly to the side link

Part No.	Max Ø [mm] hose	Form	Installation side link	Combination with snap-open crossb.
450.15.RHD115	115	○	-	+
450.17.RD115	115	○	+	-
450.25.D150	150	□	+	-
450.30.D200	200	□	+	-
450.35.D250	250	□	+	-
450.40.D300	300	□	+	-
450.20.HD150	150	□	-	+
450.25.HD200	200	□	-	+
450.30.HD250	250	□	-	+

○ = round □ = square + = yes / - = no



### E4 clip-on cable binder

- For side-mounted applications ● Serves as a clip-on, lateral guide for hoses and cables on E-Chains®
- The loops can be adjusted as required ● Compatible with many E4 E-Chains® ● Stylish and economical
- One clip and one locking band are needed for each chain link ● Call us if you have any questions on project planning

Part No.	Form
450.B12	Locking clip, comprising a locking element
450.B12.200	Locking band, comprising a locking element and band; 12 x 1,5 x 200 mm



**Option steel - pivoting**

- For pivoting connections
- One part (two-piece) for all chain widths
- Electrically conductive

**Fixed end**  
16000.2

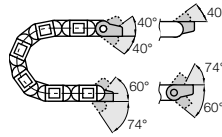

**Moving end**  
16000.1

Possible installation conditions -  
Further installation angles ► installation sketch

**Moving end**  
16000.1

**Fixed end**  
16000.2

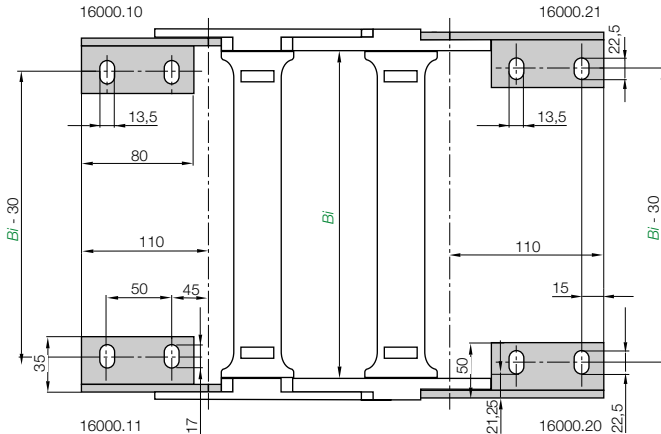

Part No.	Mounting bracket
16000.1.12	Full attachment set (both sides) for E-Chain®, ending with outer side link
16000.3.12	Full attachment set (both sides) for E-Chain®, beginning with outer side link (moving end), ending with inner side link (fixed end)
16000.1	Mounting bracket set (one side) for outer side link
16000.2	Mounting bracket set (one side) for inner side link

**Note mounting brackets:**  
Depending on the E-Chain® length, the carrier will end with outer or inner side links. For the best appearance, make sure the chain ends with outer side link whenever possible. An odd number of links will always end with outer side links.

E4/light | Series 1640-R1608 | Accessories | Strain Relief

Tiewrap plate	No. of teeth n	Dim. C [mm]	Dim. B [mm]	Center bore
3050.ZB	5	50	30	-
3075.ZB	7	75	55	-
3100.ZB	10	100	80	-
3115.ZB	11	115	95	-
3125.ZB	12	125	105	-
3150.ZB	15	150	130	-
3175.ZB	17	175	155	-
3200.ZB	20	200	180	+
3225.ZB	22	225	205	+
3250.ZB	25	250	230	+

(- = no / + = yes)

**Tiewrap plate as individual part**

As individual component screwed on KMA. Can be plugged in the mounting brackets. **Details ► chapter 10**

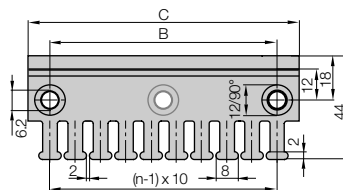

Single tiewrap plate

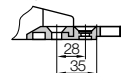

Shown assembled



► chapter 10



► page 7.161

- Ba** = Outer width E-Chains® / E-Tube
- Bi** = Inner width E-Chains® / E-Tube
- ha** = Outer height E-Chains® / E-Tube
- H<sub>Ri</sub>** = Inner trough height
- H<sub>Ra</sub>** = Outer trough height
- B<sub>Ri</sub>** = Inner trough width ► depends on dim. Ba
- B<sub>Ra</sub>** = Outer trough width
- n<sub>Mon</sub>** = Number of installation sets (left/right)
- n<sub>Ri</sub>** = Number of trough sets (left/right)
- H<sub>Ri</sub> ≥ 2 • ha**
- B<sub>Ri</sub> ≥ Ba + 5**

- = Guide trough set
- = Glide bar
- = Installation set
- = C-profile

### Installation set with C-profile

1640.12.300.0 ► Order example

	Part No.	Installation set
.05	89	-
.06	104	98.50.225
.07	114	98.50.250
.10	139	98.50.275
.11	151	98.50.275
.12	164	98.50.300
.13	176	98.50.300
.15	189	98.50.325
.16	201	98.50.325
.17	214	98.50.350
.18	226	98.50.350
.20	239	98.50.375
.21	251	98.50.375
.22	264	98.50.400
.23	276	98.50.400
.25	289	98.50.425
.26	301	98.50.425
.27	314	98.50.450
.28	326	98.50.450
.30	339	98.50.475
.31	351	98.50.475
.32	364	98.50.500
.33	376	98.50.500
.35	389	98.50.525
.36	401	98.50.525
.37	414	98.50.550
.38	426	98.50.550
.40	439	98.50.575
.41	451	98.50.575
.42	464	98.50.600
.43	476	98.50.600
.45	489	98.50.625
.46	501	98.50.625
.47	514	98.50.650
.48	526	98.50.650
.50	539	98.50.675
.51	551	98.50.675
.52	564	98.50.700
.53	576	98.50.700
.55	589	98.50.725
.60	639	98.50.775

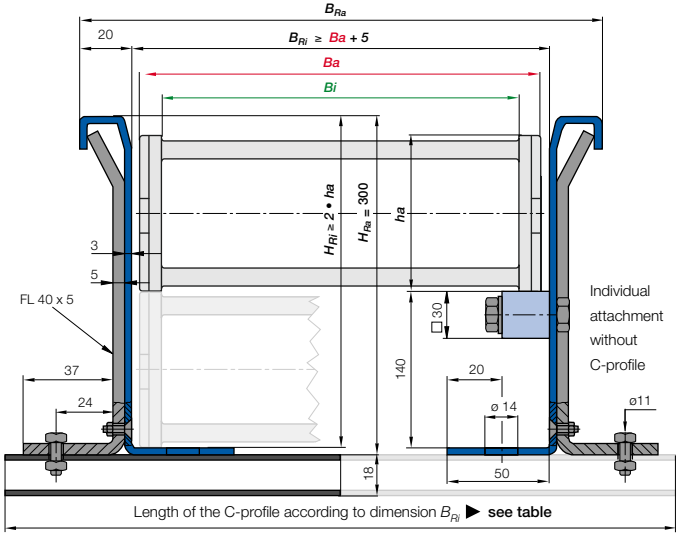

Guide troughs are used with applications where the upper run of the E-Chain® glides on the lower run. If using igus® steel guide troughs, the following components are required:

- **Guide trough without glide bars**  
Part No. 98.30
- **Guide trough with glide bars**  
Part No. 98.31
- **Installation sets as end connectors**  
Part No. 98.50.XX

.XX indicates the length of the C-profile on which the guide trough is mounted. The values and part numbers are specified in the table on the left. Standard length of the trough components and glide bars is 2 m. The required overall length of the guide trough directly correlates to the length of travel. Special dimensions are available for confined spaces.



Illustration top: Guide trough with and without glide bar. Illustration bottom: installation set



**Order example: Length of travel 30 m - Center mounted for Series 1640.12.300.0 with B<sub>Ri</sub> = 164**

Guide trough set (set of 2 trough side parts, incl. glide strips) <b>without</b> glide bar	
<b>Order text: 16 m Guide trough without glide bar (8 x 2 m sections)</b>	<b>Part No. 98.30</b>
Guide trough set (set of 2 trough side parts, incl. glide strips) <b>with</b> glide bar	
<b>Order text: 16 m Guide trough with glide bar (8 x 2 m sections)</b>	<b>Part No. 98.31</b>
Installation set "Basic" complete (Guide trough-sets + 1)	
<b>Order text: 17 Installation sets (with C-profile)</b>	<b>Part No. 98.50.300</b>

Principle sketch: Number of installation sets to be installed = **Number of trough sections + 1**

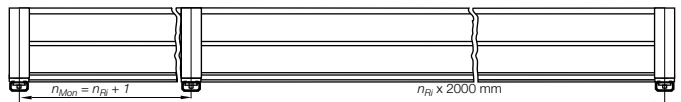

Phone +49- (0) 22 03-96 49-800  
Fax +49- (0) 22 03-96 49-222

igus® GmbH  
51147 Cologne

Internet: www.igus.de  
E-mail: info@igus.de



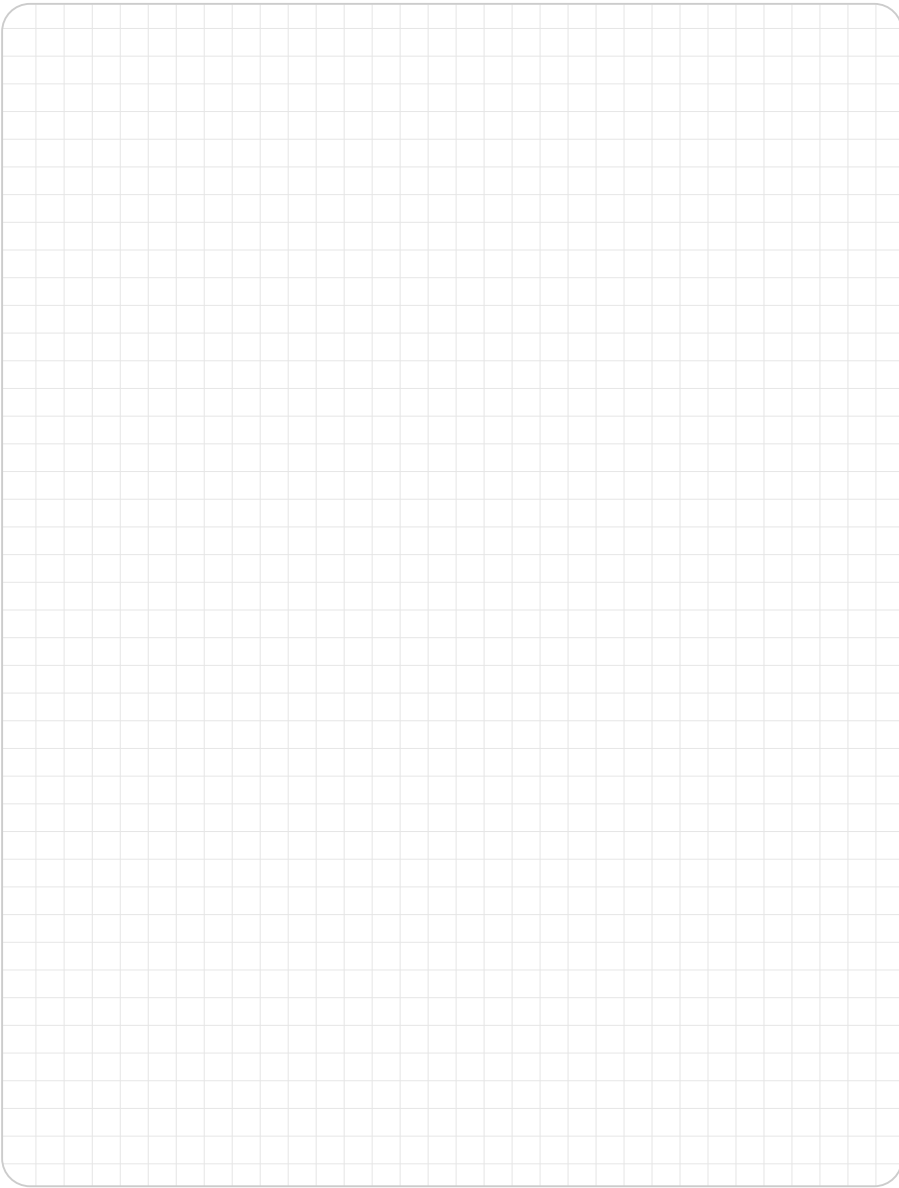

System E4/light  
Inner height: 112 mm

Phone +49- (0) 22 03-96 49-800  
Fax +49- (0) 22 03-96 49-222



▶ chapter 9



▶ page 7.161

## High resistance to oil - Chainflex® CF7 PUR-control cable

PUR-outer jacket, oil-resistant and coolant-resistant, flame-retardant, notch-resistant, hydrolysis-resistant and microbe-resistant. Further information: [www.igus.de/en/CF7](http://www.igus.de/en/CF7)

IGUS® CHAINFLEX® CF7



# E3...T3...





...E6

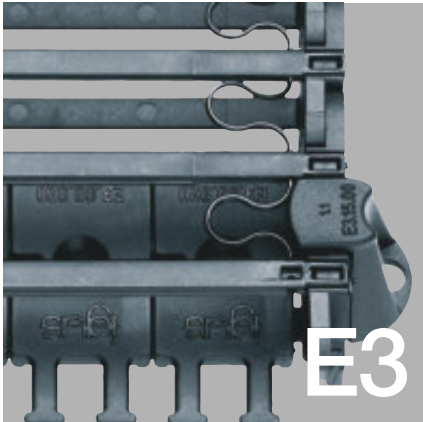

**E3**

**System E3 - Elastic, dampening connector strip replaces pins and bores**

- Superquiet E-Chain® for small spaces with modular 3-piece link design
- 3 Sizes available
- Interior heights: 10 mm, 15 mm, 22 mm

**System E3 ▶ from page 8.4**

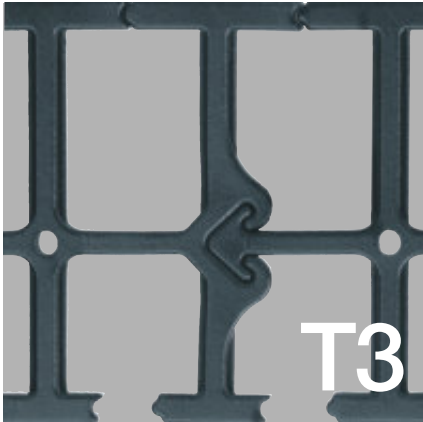

**T3**

**System T3 - Highly flexible, low-vibration band chain without pin and bore connection**

- For short strokes with extreme demands on low noise and dynamics
- For high speed and high accelerations
- Very low weight
- Hardly any abrasion
- Cost-efficient, 3-piece E-Chain®

**System T3 ▶ from page 8.22**

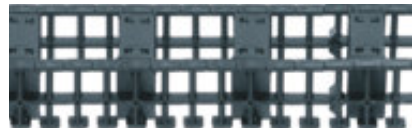

**E6**

**System E6 - connector replaces pins and bores**

- Superquiet E-Chain® with high stability and tensile strength and modular 6-piece link design
- 5 Sizes available
- 3 Types available (E-Chain®, E-Tube and Light-Version)
- Interior heights: 29 mm, 40 mm, 52 mm, 62 mm, 80 mm

**System E6 ▶ from page 8.34**



### The extremely low-noise igus® E-Chain® - E3, T3 and E6 Systems

The E-Chain® of the E3, T3 and E6 Series have extremely good low noise and vibration performance. The special, abrasion-resistant spring elements replace the conventional pin and bore connection of the chain links enabling the low noise and vibration operation of the E-Chain®. Due to the special fastening system, the E-ChainSystems® have low wear or abrasion and are

therefore suitable for cleanroom applications. Another advantage of the connector is that in the application of an electrically conductive material (igumid ESD on request) it can guarantee a constant conductance value. The E-Chain® Series E3, T3 and E6 offer an extensive accessories package and are available in many dimensions of the shelf.

### Measurement values of sound pressure levels dB(A) in comparison

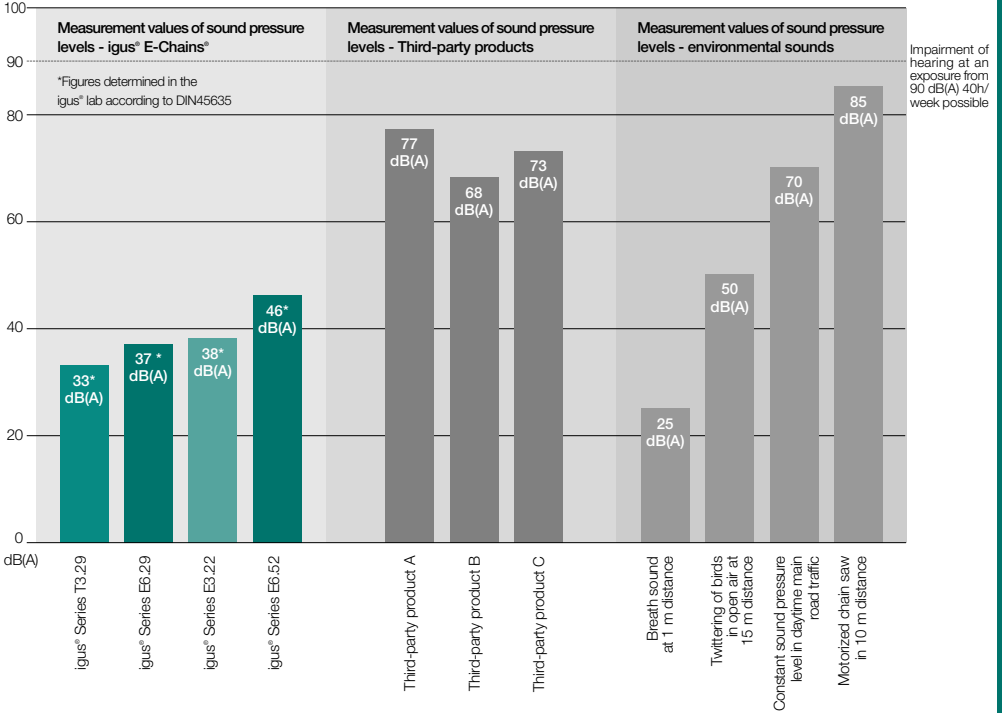

### igus® goes clean room - qualification of E3 and E6 E-Chains®

IPA Fraunhofer Institute has tested igus® Series E3, E4, E6 and EasyChain® as follows:

- ISO class 1, as per stringent norm DIN EN ISO 14644-1 for System E3, Series E3.15.040.075.0 at v = 0,5 m/s, 1 m/s, 2 m/s
- ISO class 1, as per stringent norm DIN EN ISO 14644-1 for System E6 - special material\*, Series E6.29.060.150.0 at v = 0,5 m/s, 2 m/s
- ISO class 3, as per stringent norm DIN EN ISO 14644-1 for System E6 - standard material, Series E6.29.060.150.0 at v = 0,5 m/s, 1 m/s, 2 m/s
- ISO class 3, as per stringent norm DIN EN ISO 14644-1 for System E6, Series E6.29.050 at v=1 und 2 m/s

Class per DIN EN ISO 14644-1	Equivalent to VDI 2083	Equivalent to US Fed.Std. 209E	Classification Series	Speed [m/s]
ISO class 1	no comparable classification	no comparable classification	E3.15.040.075.0	0,5 / 1,0 / 2,0
ISO class 2	no comparable classification	no comparable classification	E6.29.060.150.0*	0,5 / 2,0
ISO class 3	class 1	class 1	E6.29.060.150.0	0,5 / 1,0 / 2,0
ISO class 4	class 2	class 10		
ISO class 5	class 3	class 100		
ISO class 6	class 4	class 1.000		
ISO class 7	class 5	class 10.000		
ISO class 8	class 6	class 100.000		

\*special material\* "clean room"

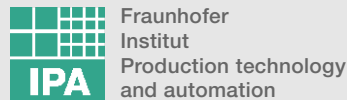



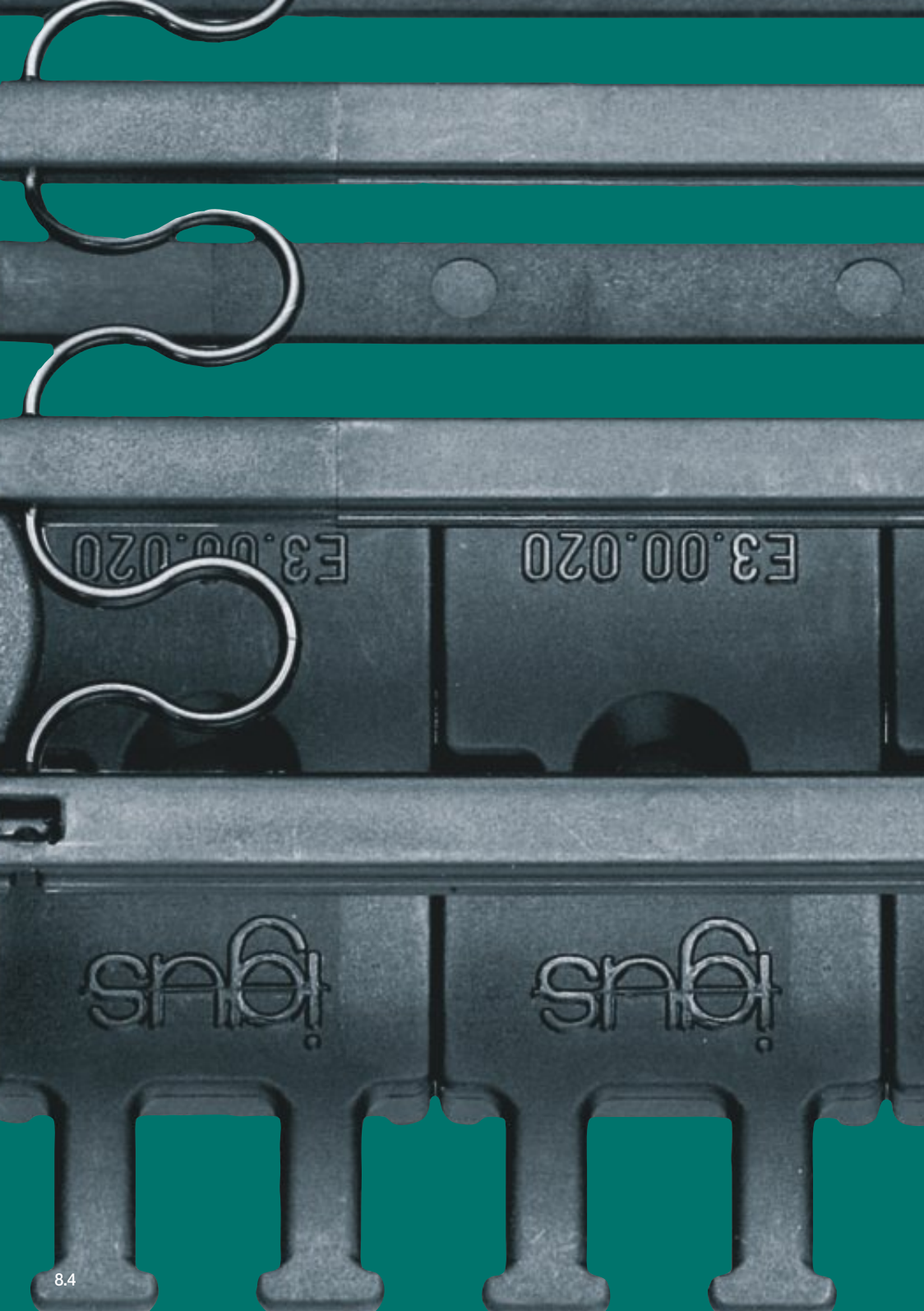

E3.00.020

E3.00.020

富士

富士



**E3**



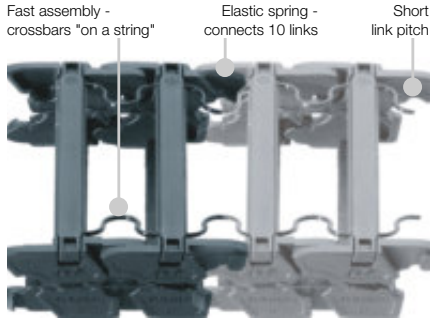

E3 = E-Chains® with 3 different elements in one link:

- U-shaped link body
- Spring element
- Crossbars "on a string"

## E3: System for highly dynamic applications

Cycle times in automation get shorter, while demands for low noise and vibration levels are increasing. For the broad range of small size E-Chain® applications, igus® now introduces the new product family System E3, that fully meets those requirements:

- Extremely low-noise operation - max. 38 dB(A)
- Elastic, dampening connector strip replaces pins and bores
- Modular 3-piece link design
- Cost effective cross bar-, separator and connector modules
- Fast an easy cable access due to zipper opening mechanism
- Good unsupported strength due to solid, interlocking side links
- Easy lengthening and shortening
- Also suits flat cables
- Accessories: Separators, integrated strain relief, mounting brackets
- You can find more technical data about the material, chemical resistance, temperatures ► **chapter Design, from page 1.38**

### Opening-principle



System E3 - zip-open along outer radius

### Dimensioning

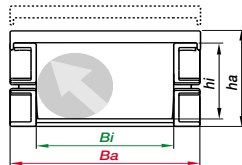

### Bending radius

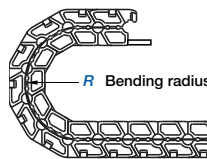

### Part No. structure

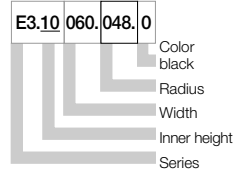

### Selection table

Series	Inner height <i>hi</i> [mm]	Inner width <i>Bi</i> [mm]	Outer width <i>Ba</i> [mm]	Outer height <i>ha</i> [mm]	Bending radius <i>R</i> [mm]	Unsupported length max. [m]	Page
E3.10.	10	20 - 60	32 - 72	15	15 - 48	≈ 0,75	8.10
E3.15.	15	20 - 60	32 - 72	20	32 - 75	≈ 0,90	8.14
E3.22.	22	20 - 60	32 - 72	27	44 - 75	≈ 1,20	8.18



# System E6

Larger inner heights from 29 to 80 mm, higher unsupported lengths

► from page 8.34

### Comparison of the main characteristics

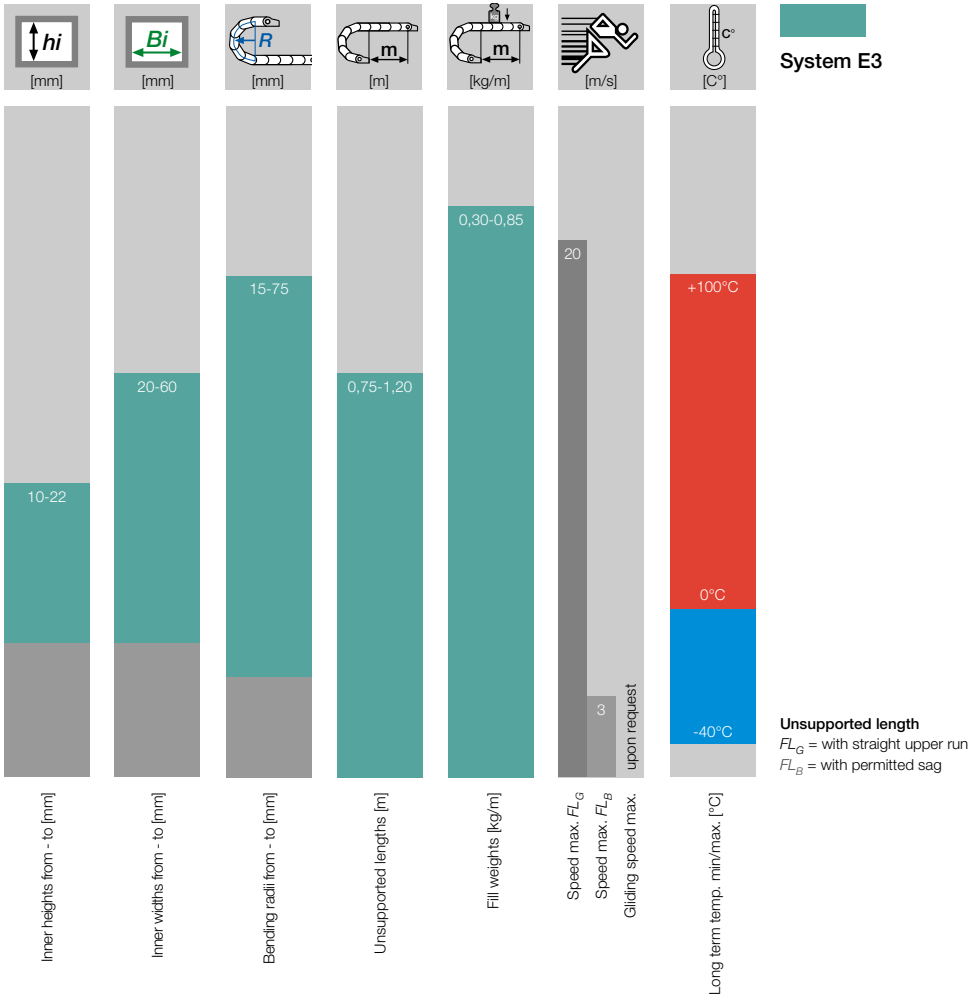

### Additional quality features - System E3

38dB(A) - Figure determined in the igus® laboratory in accordance with DIN 45635, taking into consideration background noises, for the E3.22.060.44 Series at  $v = 1.8$  m/s

iF-Design Award 2005

IPA Qualification Certificate: ISO Class 1, according to Norm DIN EN ISO 14644-1 for System E3, Series E3.15.040.075.0 at  $v = 0,5$  m/s, 1 m/s, 2 m/s

Special equipment: Electrically conductive ESD/ATEX version upon request

► Next Page: Find application examples and assembly instructions

3-piece E-Chain®, featuring many new ideas - The new igus® System E3 combines small pitches, smooth running, low noise, stability, easy assembly and economic efficiency all in one. The spring connector element replaces the pin and bore principle and avoids relative movements between the joints. This means virtually no wear or abrasion for Cleanroom applications. To reduce production and assembling costs, the spring connector is not mounted individually, but on a length of ten chain links. Another E3 option is safe performance. A modified spring element made of electrically conductive material, which connects the chain links mechanically and electrically, permanently guarantees constant electrical conductance, even at high bending stress and in any position.

### Typical industries & applications

- Semi-conductor manufacturing and handling
- Optic
- Pick and place robots
- Handlings and robots
- Other material handling applications
- Applications where micro chains are being used
- Printers and plotters
- Cleanroom environments



Light-weight and super-silent in small spaces - The new System E3

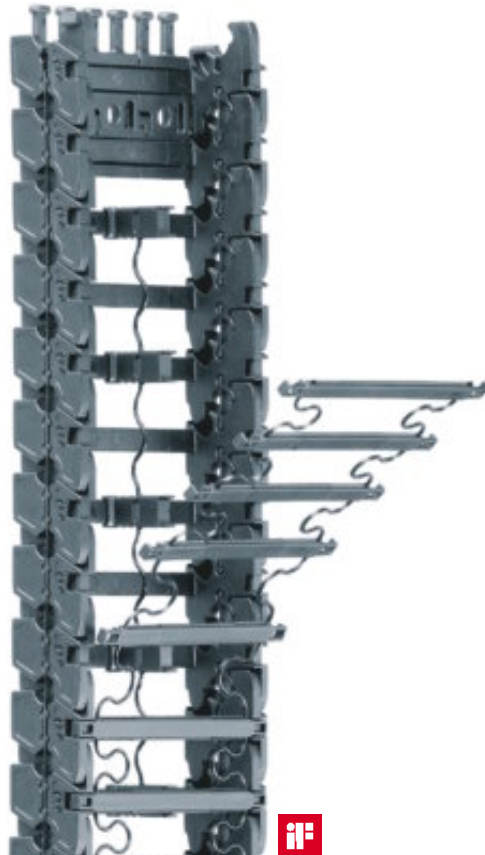

An elastic thread connects crossbars as well as separators and accelerates assembly

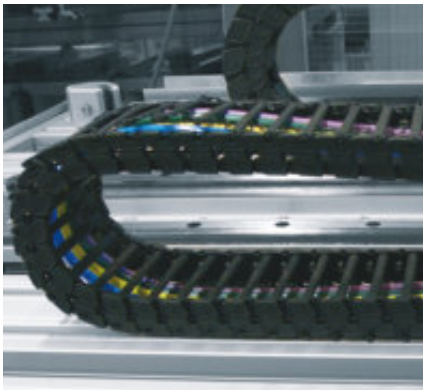

Long-term tests in the igus® acoustic laboratory showed reductions of 19-20 db(A) compared with standard E-Chains®, measured at a speed of 1.8 m/s and an acceleration of 3 m/s



During long-term tests the System E3 with the spring band connector easily passes 15 million cycles at a bending radius of 44 mm and an acceleration of 4 g

System E3 | 3-piece E-Chain®

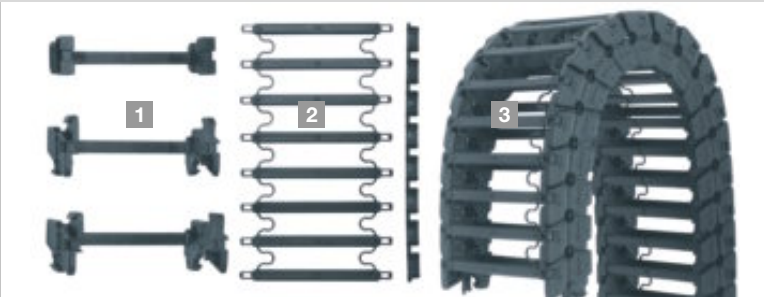

The abbreviation "E3" stands for an E-Chain® consisting of three basic elements:

- ❶ Chain link body
- ❷ Zipper style opening lids
- ❸ Separator module

System E3 | Opening | Closing



Zipper style opening lids on a band for quick and easy installation - The new E-ChainSystem® allows faster assembling times. Opening and closing the E-Chain® is made by "zipperbars on a thread"

System E3 | Interior Separation | Strain Relief



Vertical separators on a band divide carrier space - Five separators in one thread are simultaneously mounted on the crossbars

The universal strain relief can be individually matched to the chain width. You can fix the E-Chain® on the fixed end with brackets (option)



You can find an assembly video on the web ► [www.igus.de/en/video](http://www.igus.de/en/video)



Price index



Smooth motion due to tested and tried "E6" design principle, 38dB(A) - Figure determined in the igus® laboratory in accordance with DIN 45635. (at  $v = 1,8$  m/s)



IPA Qualification Certificate:  
Cleanroom test upon request



Special equipment:  
Electrically conductive  
ESD/ATEX version upon request

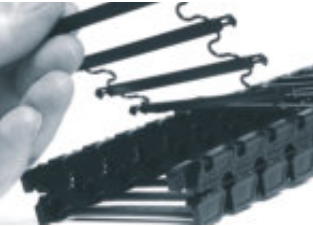

Rapid assembly time with "zipperbars on a strip"

**When to use the Series E3.10:**

- If a low-noise, vibration-free version is required
- At very high speeds and/or accelerations (Theoretically up to 100 g or 1000 m/s)
- Hard-wearing E-Chain® (more than 50 million cycles without abrasion)
- If a very light E-Chain® is required (up to 40% lighter than a comparable E2-E-Chain®)
- For the use of flat cables
- For small bending radii and small spaces
- If easy filling and assembly is required
- Minimal abrasion (e.g. cleanroom applications)

**When not to use it:**

- If a particularly low-cost, snap-open solution is required
- ▶ Series E/Z06 Easy Chain®, page 3.20
- If a simple, non snap-open E-Chain® is required
- ▶ Series 05 E2 micro, page 5.22

- 1 Smooth running, due to the igus® approved "E6-Principle", 38dB(A) max.\*
- 2 For high speed and high accelerations
- 3 Small pitch
- 4 3-piece Design
- 5 Modular design- opening crossbars, interior separation and link all in one band
- 6 Easy cable access due to fast zip-open mechanism
- 7 Easy shortening/lengthening
- 8 Suits flat cables
- 9 Accessories, such as interior separations, strain relief and mounting bracket, are available

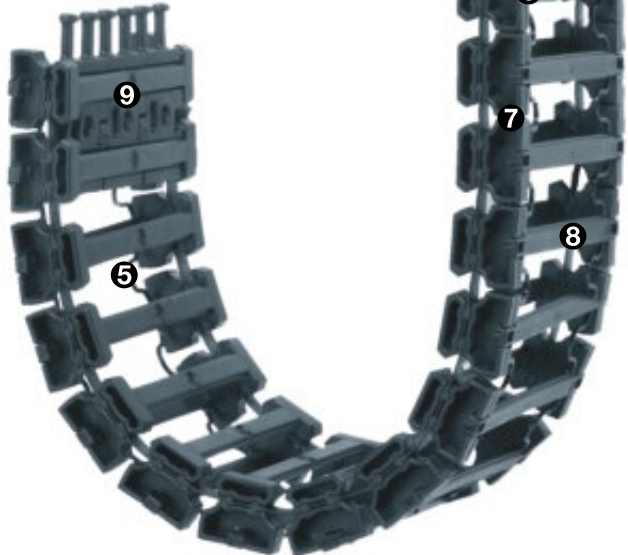
**Order example complete E-Chain®**Please indicate chain-lengths or number of links **Example: 1 m or 60 links**1 m **E3.10.060.015.0****E-Chain®**with 2 separators **E3.10.11** assembled every 2<sup>nd</sup> link**Interior separation**1 set **E3.10.060.12****Mounting bracket**

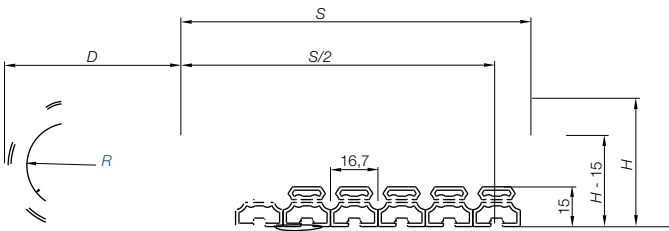
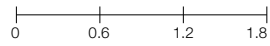
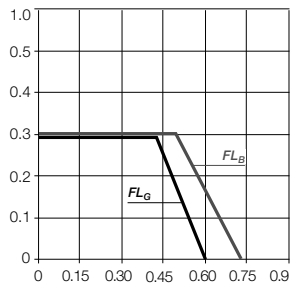

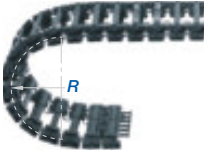
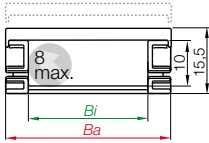

## Series E3.10 - snap-open along outer radius

Part No.	$B_i$ [mm]	$B_a$ [mm]	$R$ [mm]	Bending radii	Weight [kg/m]
E3.10.020.□.0	20	32	015	028	~ 0,12
E3.10.040.□.0	40	52	015	038 048	~ 0,15
E3.10.060.□.0	60	72	015		~ 0,20

Supplement Part No. with required radius. Example: E3.10.060.015.0

0 = standard color, other colors ► page 1.39 · Pitch = 16,7 mm/link - Links/m = 60

Part No. structure

E3.10.060.015.0

 Vertical separator,  
 slotted (single)

unassembled E3.10.01

assembled E3.10.11



## Vertical separators

Vertical separators are used if a vertical subdivision of the E-Chain® interior is required -

- Subdivision with vertical separator E3.10.11 (slotted 3 times)

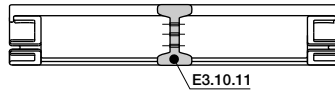





### Mounting angle - Polymer

- For fastening the E-Chain® to the fixed end
- Simple fastening to base is possible
- Corrosion-resistant
- Various mounting options
- Easy to assemble

Moving end  
E3.10...1

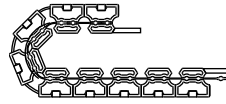

E3.10.....2  
Fixed end

Example: Possible installation conditions for E3 mounting brackets

E3.10.....2  
Fixed end

E3.10...1  
Moving end

### Dimensions and order configurations

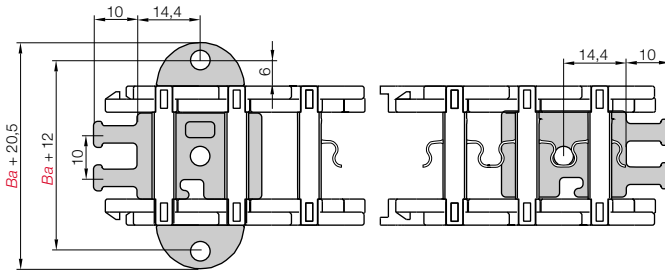

Part No. structure

E3.10. 020. 12



For E-Chain®	Part No. full set strain relief for both sides + 2 mounting angles	Part No. strain relief for both sides	Part No. mounting angle (single part)
E3.10.020.	▶ E3.10.020.12	E3.020.12	E3.10.00
E3.10.040.	▶ E3.10.040.12	E3.040.12	E3.10.00
E3.10.060.	▶ E3.10.060.12	E3.060.12	E3.10.00

Full set, for both ends:

Single-part order:

Moving end mounting bracket

Fixed end mounting bracket

E3.10.XXX.12



E3 with strain relief for both sides and mounting angles

E3.00.020



Strain relief for both sides as single parts

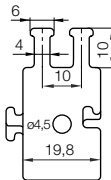

E3.10.00



Mounting angle as single part

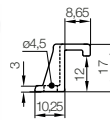

Phone +49- (0) 22 03-96 49-800  
Fax +49- (0) 22 03-96 49-222





Price index



Smooth motion due to tested and tried "E6" design principle, 38dB(A) - Figure determined in the igus® laboratory in accordance with DIN 45635. (at  $v = 1,8$  m/s)



IPA Qualification Certificate:  
Cleanroom test upon request



Special equipment:  
Electrically conductive  
ESD/ATEX version upon request

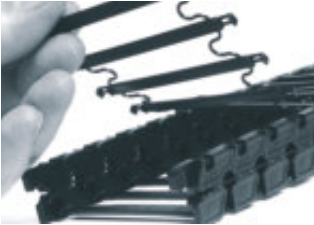

Rapid assembly time with "zipperbars on a strip"

**When to use the Series E3.15:**

- If a low-noise, vibration-free version is required
- At very high speeds and/or accelerations (Theoretically up to 100 g or 1000 m/s)
- Hard-wearing E-Chain® (more than 50 million cycles without abrasion)
- If a very light E-Chain® is required (up to 40% lighter than a comparable E2-E-Chain®)
- For the use of flat cables
- For small bending radii and small spaces
- If easy filling and assembly is required
- Minimal abrasion (e.g. cleanroom applications)

**When not to use it:**

- If a particularly low-cost, snap-open solution is required
- ▶ Series E/Z08 Easy Chain®, page 3.38
- If a simple, non snap-open E-Chain® is required
- ▶ Serie 08 E2 micro, page 5.30

- 1 Smooth running, due to the igus® approved "E6-Principle", 38dB(A) max.\*
- 2 For high speed and high accelerations
- 3 Small pitch
- 4 3-piece Design
- 5 Modular design- opening crossbars, interior separation and link all in one band
- 6 Easy cable access due to fast zip-open mechanism
- 7 Extensive external bearing surfaces and high load capacity by means of interlocking bearing surfaces
- 8 Easy shortening/lengthening
- 9 Suits flat cables
- 10 Accessories, such as interior separations, strain relief and mounting bracket, are available

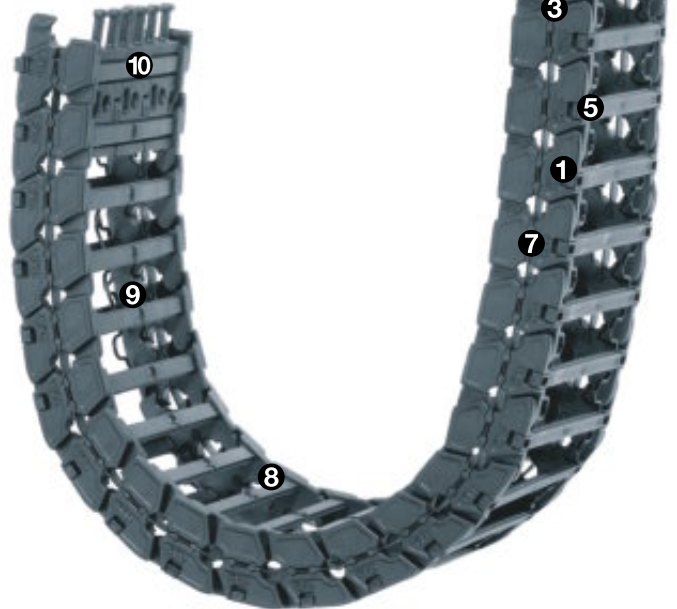
**Order example complete E-Chain®**Please indicate chain-lengths or number of links **Example: 1 m or 60 links**1 m **E3.15.060.032.0****E-Chain®**with 2 separators **E3.15.11** assembled every 2<sup>nd</sup> link**Interior separation**1 set **E3.15.060.12****Mounting bracket**

**Unsupported length**

$FL_G$  = with straight upper run

$FL_B$  = with permitted sag

Further information ► **Design, page 1.12**

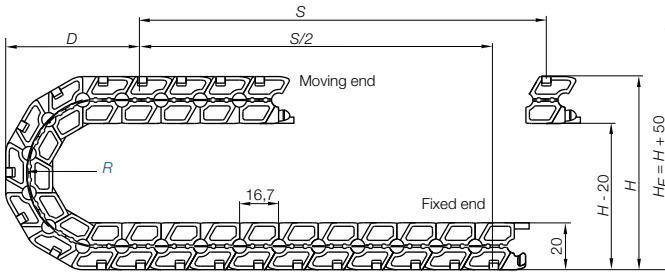
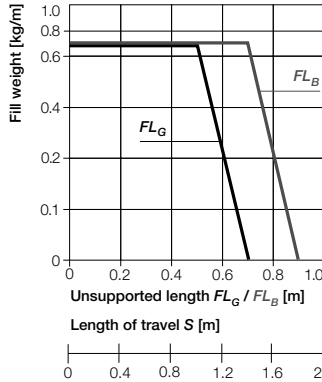
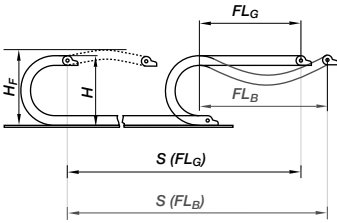

Pitch = 16,7 mm/link Links/m = 60 (1.002 mm) Chain length =  $S/2 + K$

R	032	038	048	075
H	84	96	116	170
D	59	65	75	102
K	135	155	185	270

- S = Length of travel
- R = Bending radius
- H = Nominal clearance height
- H<sub>F</sub> = Required clearance height
- D = Overlength E-Chain® radius in final position
- K =  $\pi \cdot R + \text{"safety"}$



**Short travels - unsupported**

Unsupported E-Chains® feature positive camber over short travels. This must be accounted for when specifying the clearance height  $H_F$ . Please consult igus® if space is particularly restricted.

The required clearance height:  
 $H_F = H + 50$  mm  
 (with 0,2 kg/m fill weight)



System E3  
 Inner height: 15 mm

Phone +49- (0) 22 03-96 49-800  
 Fax +49- (0) 22 03-96 49-222



**Low weight, high accelerations -**

**igus® E3 system.** Suitable for high accelerations due to the low weight and for this reason, has extremely low-noise operation. Long-term tests in our acoustic lab showed reductions of 19-20 dB(A) compared to conventional E-Chain® systems at a speed of 1.8 m/s and an acceleration of 3 m/s. **More information [www.igus.de](http://www.igus.de)**



**TIP!**

Speed / acceleration $FL_G$	max. 20 [m/s] / max. 200 [m/s <sup>2</sup> ]
Speed / acceleration $FL_B$	max. 3 [m/s] / max. 6 [m/s <sup>2</sup> ]
Gliding speed / acceleration (maximum)	upon request
permitted temperature °C	-40° up to +100° C
Flammability class	VDE 0304 IIC UL94 HB

**Technical Data**



Details of material properties  
 ► page 1.38



► page 8.9

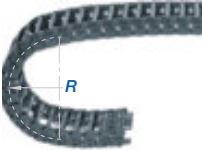
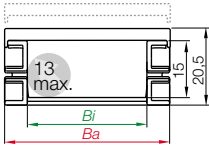

## Series E3.15 - snap-open along outer radius

Part No.	$B_i$ [mm]	$B_a$ [mm]	$R$ [mm]	Bending radii			Weight [kg/m]
E3.15.020.□.0	20	32	032	038	048		≈ 0,22
E3.15.040.□.0	40	52	032	038	048	075	≈ 0,25
E3.15.060.□.0	60	72	032	038	075		≈ 0,32

Supplement Part No. with required radius. Example: E3.15.060.032.0

0 = standard color, other colors ► page 1.39 · Pitch = 16,7 mm/link - Links/m = 60

Part No. structure

E3.15.060.032.0

**Vertical separator,  
slotted (single)**

unassembled E3.15.01

assembled E3.15.11

**Vertical separator  
on a strip**

unassembled E3.15.01.10

assembled E3.15.11.10



## Vertical separators

Vertical separators are used if a vertical subdivision of the E-Chain® interior is required -

- Subdivision with **vertical separator E3.15.11** (slotted 3 times)
- Five vertical separators altogether on one strip over ten chain links are mounted on the opening crossbars. In this way, controlled chambers are formed, which prevent the sensitive electrical circuit from outage

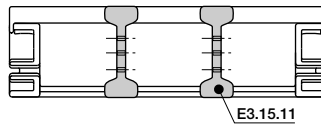



### Mounting angle - Polymer

- For fastening the E-Chain® to the fixed end
- Simple fastening to base is possible
- Corrosion-resistant
- Various mounting options
- Easy to assemble

Moving end  
E3.15...1

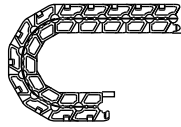

E3.15.....2  
Fixed end

Example: Possible installation conditions for E3 mounting brackets

E3.15.....2  
Fixed end

E3.15...1  
Moving end

### Dimensions and order configurations

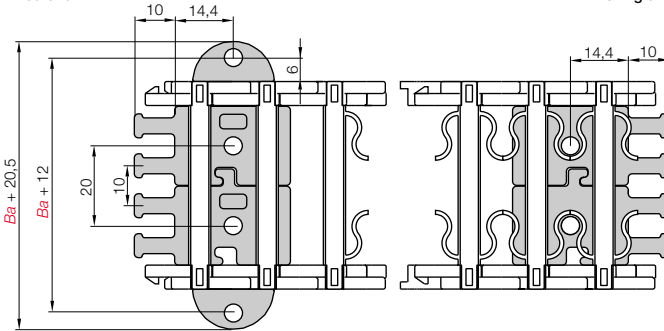

Part No. structure

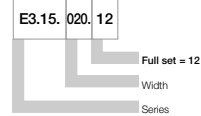

For E-Chain®	Part No. full set strain relief for both sides + 2 mounting angles	Part No. strain relief for both sides	Part No. mounting angle (single part)
E3.15.020.	▶ E3.15.020.12	E3.020.12	E3.15.00
E3.15.040.	▶ E3.15.040.12	E3.040.12	E3.15.00
E3.15.060.	▶ E3.15.060.12	E3.060.12	E3.15.00

Full set, for both ends:

E3.15. 020. 12

Single-part order:

E3.15. 020. 1

Moving end mounting bracket

E3.15. 020. 2

Fixed end mounting bracket

E3.15.XXX.12



E3 with strain relief for both sides and mounting angles

E3.00.020



Strain relief for both sides as single parts

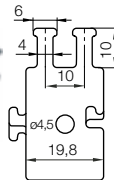

E3.15.00



Mounting angle as single part

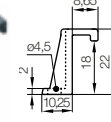

Phone +49- (0) 22 03-96 49-800  
Fax +49- (0) 22 03-96 49-222



▶ page 8.9



Price index



Smooth motion due to tested and tried "E6" design principle, 38dB(A) - Figure determined in the igus® laboratory in accordance with DIN 45635. (at  $v = 1,8$  m/s)



IPA Qualification Certificate:  
Cleanroom test upon request



Special equipment:  
Electrically conductive  
ESD/ATEX version upon request

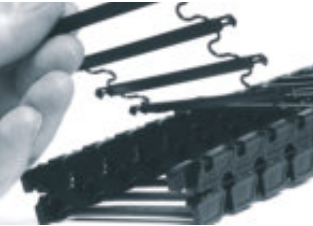

Rapid assembly time with "zipperbars on a strip"

**When to use the Series E3.22:**

- If a low-noise, vibration-free version is required
- At very high speeds and/or accelerations (Theoretically up to 100 g or 1000 m/s)
- Hard-wearing E-Chain® (more than 50 million cycles without abrasion)
- If a very light E-Chain® is required (up to 40% lighter than a comparable E2-E-Chain®)
- For the use of flat cables
- For small bending radii and small spaces
- If easy filling and assembly is required
- Minimal abrasion (e.g. cleanroom applications)

**When not to use it:**

- If a particularly low-cost, snap-open solution is required
- ▶ Series E/Z14 Easy Chain®, page 3.32
- If a simple, non snap-open E-Chain® is required
- ▶ Series 1400/1450/1480/1500 E2/000, page 5.84

- 1 Smooth running, due to the igus® approved "E6-Principle", 38dB(A) max.\*
- 2 For high speed and high accelerations
- 3 Small pitch
- 4 3-piece Design
- 5 Modular design- opening crossbars, interior separation and link all in one band
- 6 Easy cable access due to fast zip-open mechanism
- 7 Extensive external bearing surfaces and high load capacity by means of interlocking bearing surfaces
- 8 Easy shortening/lengthening
- 9 Suits flat cables
- 10 Accessories, such as interior separations, strain relief and mounting bracket, are available

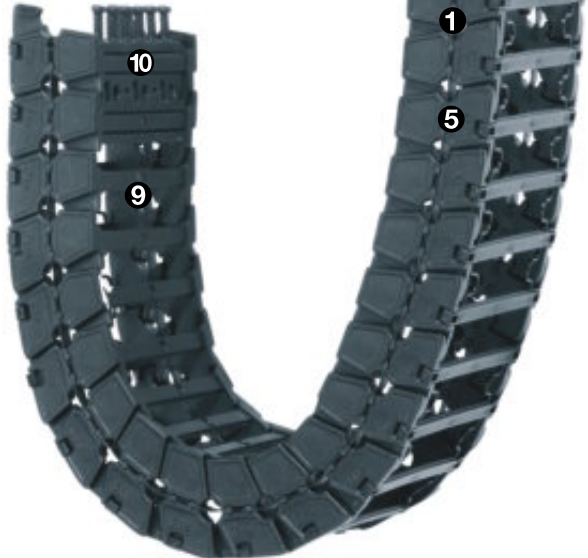
**Order example complete E-Chain®**Please indicate chain-lengths or number of links **Example: 1 m or 60 links**1 m **E3.22.060.044.0****E-Chain®**with 2 separators **E3.22.11** assembled every 2<sup>nd</sup> link**Interior separation**1 set **E3.22.060.12****Mounting bracket**

**Unsupported length**

$FL_G$  = with straight upper run

$FL_B$  = with permitted sag

Further information ► **Design, page 1.12**

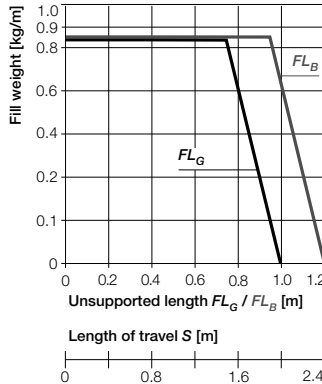
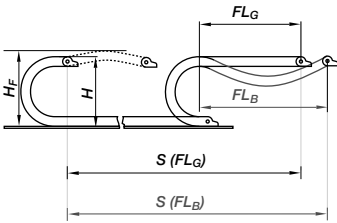

- $S$  = Length of travel
- $R$  = Bending radius
- $H$  = Nominal clearance height
- $H_F$  = Required clearance height
- $D$  = Overlength E-Chain\*  
radius in final position
- $K = \pi \cdot R + \text{"safety"}$

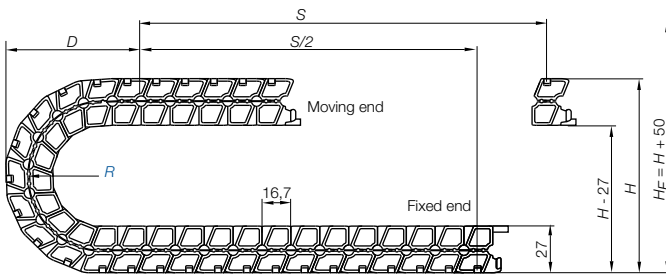

**Pitch = 16,7 mm/link Links/m = 60 (1.002 mm) Chain length =  $S/2 + K$**

R	044	050	075
H	114	126	176
D	74	80	105
K	175	195	270



**Short travels - unsupported**

Unsupported E-Chains\* feature positive camber over short travels. This must be accounted for when specifying the clearance height  $H_F$ . Please consult igus\* if space is particularly restricted.

The required clearance height:  
 **$H_F = H + 50$  mm**  
(with 0,3 kg/m fill weight)

**Stable and highly dynamic ...**

**System E3** - Long-term tests for the E3 system with the spring clip connection so far indicate a trouble-free 18.4 million cycles (status: 01/09/2004) for bending radius of 44 mm and an acceleration of 4 40 m/s<sup>2</sup> and a speed of 2 m/s. The tests continue.  
**More information: [www.igus.de](http://www.igus.de)**



Speed / acceleration $FL_G$	max. 20 [m/s] / max. 200 [m/s <sup>2</sup> ]
Speed / acceleration $FL_B$	max. 3 [m/s] / max. 6 [m/s <sup>2</sup> ]
Gliding speed / acceleration (maximum)	upon request
permitted temperature °C	-40° up to +100° C
Flammability class	VDE 0304 IIC UL94 HB

**Technical Data**



Details of material properties  
► **page 1.38**





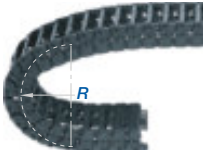
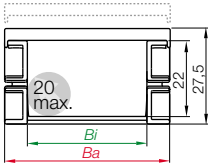

Part No. structure

E3.22.060.044.0



## Series E3.22 - snap-open along outer radius

Part No.	Bi [mm]	Ba [mm]	R [mm]	Bending radii	Weight [kg/m]
E3.22.020.□.0	20	32	044	050 075	≈ 0,30
E3.22.040.□.0	40	52	044	050 075	≈ 0,32
E3.22.060.□.0	60	72	044	050 075	≈ 0,41

Supplement Part No. with required radius. Example: E3.22.060.044.0

0 = standard color, other colors ► page 1.39 · Pitch = 16,7 mm/link - Links/m = 60



## System E3 | Series E3.22 | Accessories | Interior Separation

Vertical separator,  
slotted (single)unassembled E3.22.01  
assembled E3.22.11

## Vertical separators

Vertical separators are used if a vertical subdivision of the E-Chain® interior is required -

- Subdivision with vertical separator E3.22.11 (slotted 3 times)

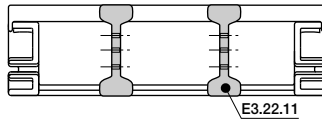



### Mounting angle - Polymer

- For fastening the E-Chain® to the fixed end
- Simple fastening to base is possible
- Corrosion-resistant
- Various mounting options
- Easy to assemble

Moving end  
E3.22...1

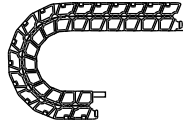

E3.22.....2  
Fixed end

Example: Possible installation conditions for E3 mounting brackets

E3.22.....2  
Fixed end

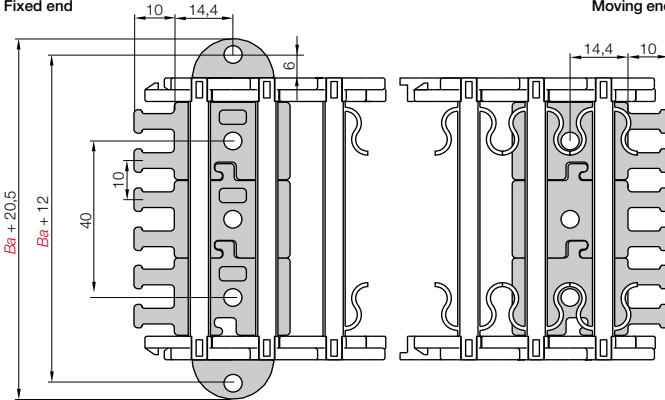

E3.22...1  
Moving end

### Dimensions and order configurations

Part No. structure

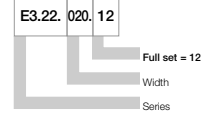

For	Part No. full set	Part No.	Part No.
E-Chain®	strain relief for both sides + 2 mounting angles	strain relief for both sides	mounting angle (single part)
E3.22.020.	▶ E3.22.020.12	E3.020.12	E3.22.00
E3.22.040.	▶ E3.22.040.12	E3.040.12	E3.22.00
E3.22.060.	▶ E3.22.060.12	E3.060.12	E3.22.00

Full set, for both ends:

E3.22.020.12

Single-part order:

E3.22.020.1

Moving end mounting bracket

E3.22.020.2

Fixed end mounting bracket

E3.22.XXX.12



E3 with strain relief for both sides and mounting angles

E3.00.020



Strain relief for both sides as single parts

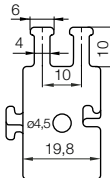

E3.22.00

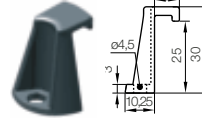

Mounting angle as single part



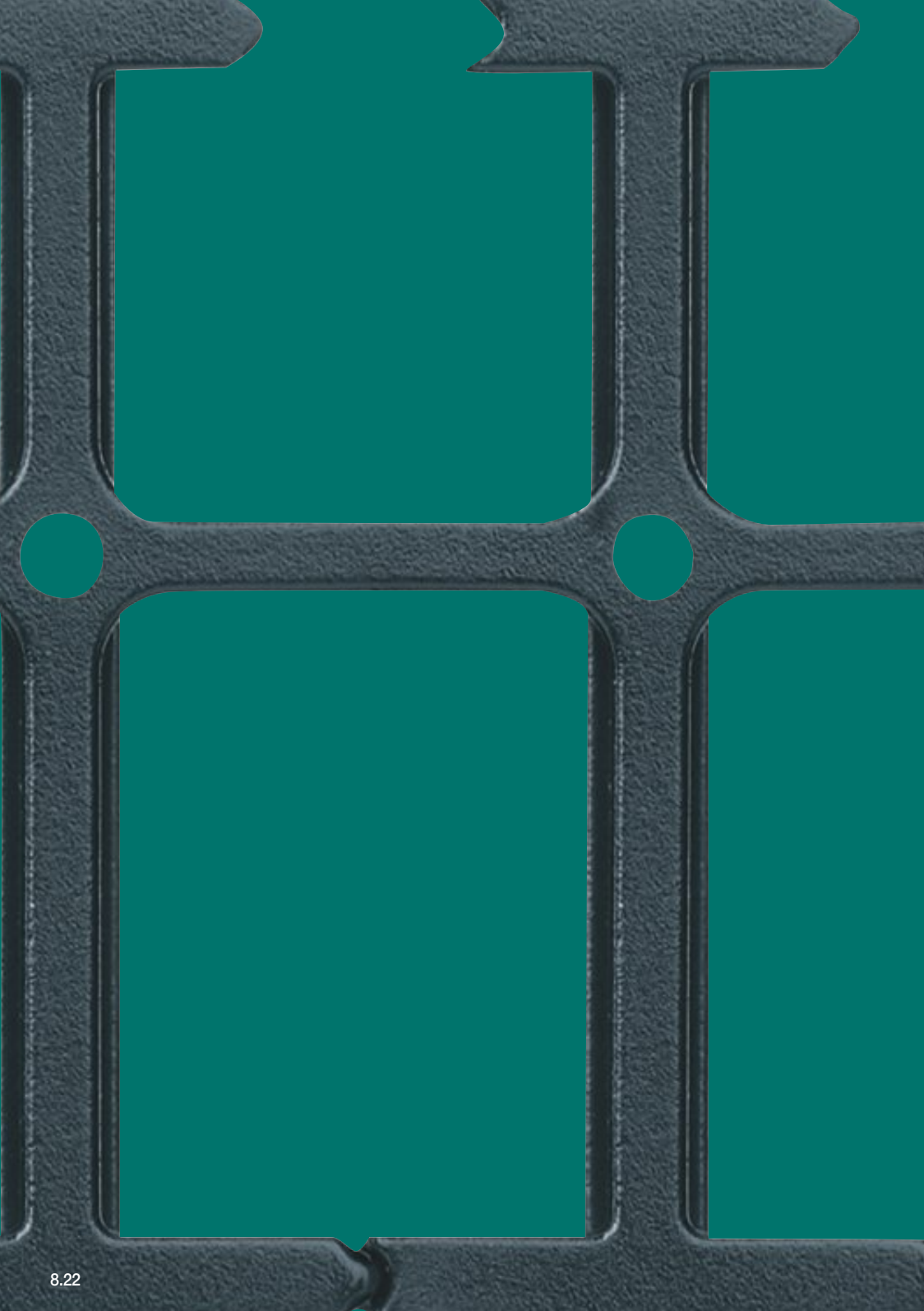



**T3**

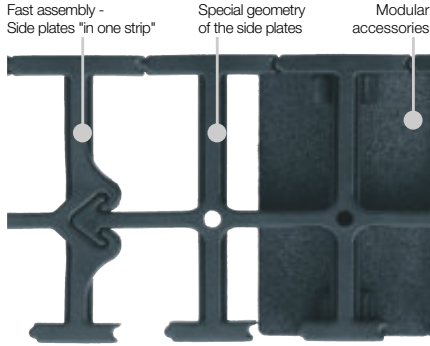

### T3: New E-Chain® band for highly dynamic applications

In the development of the new 3-piece, T-shaped band chain "T3", the main focus was on minimum operational noise with lowest cost. This is achieved by the side-plate band consisting of 8 chain links in one piece, as well as the use of existing components of the popular E6 range. The T3 band chain is extremely flexible and runs "round" due to the special geometry. The omission of a pin and bore connection means the T3 band chain features extremely low abrasion and wear and hence is good for cleanroom applications.

- Extremely low noise and low vibration
- Low-priced E-Chain® for simple applications
- For high speeds and accelerations
- Very low weight
- Hardly any abrasion
- For short strokes
- Accessories: Separators, integrated strain relief, mounting brackets
- You can find more technical data about the material, chemical resistance, temperatures ► **chapter Design, from page 1.38**

#### Opening-principle



System T3 - im  
Außenradius zu öffnen

#### Dimensioning

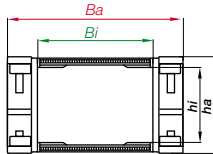

#### Bending radius

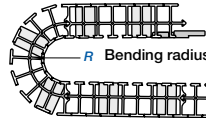

#### Part No. structure

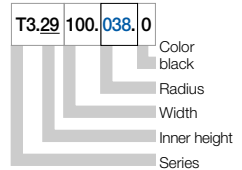

#### Selection table

Series	Inner height <i>hi</i> [mm]	Inner width <i>Bi</i> [mm]	Outer width <i>Ba</i> [mm]	Outer height <i>ha</i> [mm]	Bending radius <i>R</i> [mm]	Unsupported length max. [m]	Page
T3.29.	29	30 - 120	55 - 145	35	038	ca. 1	8.28

Comparison of the main characteristics

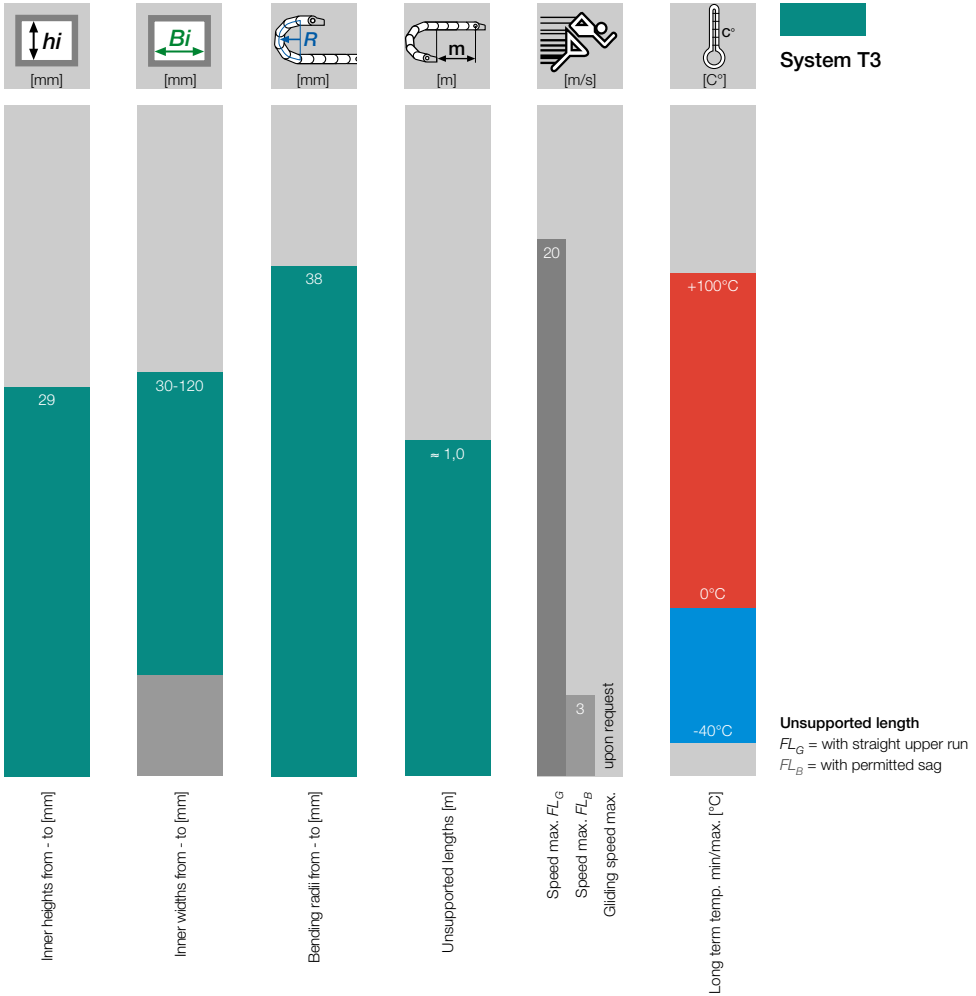

Additional quality features - System T3



igus® tests at 1 m measuring distance: = 33 dB(A) for T3.29.050.038 at v = 1 m/s und 26.5 dB(A) basic sound level



Cleanroom test in preparation

► Next Page: Find application examples and assembly instructions

**Three-piece E-Band** with many new ideas - the igus® E3 System combines low-noise operation, low sound level, simple installation and economy. The side plates that can be plugged into each other replace the conventional pin and bore connection and prevent relative movements between the joints, giving an almost complete freedom from wear. By the novel geometrical shape of the T band, hardly any polygon effect is generated operation. The T band operates in a very smooth arc giving extremely low vibration and noise. In order to reduce the manufacturing and installation costs, the T band is mounted in a length of 8 chain links. Due to its low mass, the igus® T band, combined with high speeds and accelerations, is suitable for applications with low fill weights and short strokes.

### Typical industries & applications

- Printer and plotter
- Application in cleanroom
- Production and processing of semiconductors
- Optics
- Automatic insertion machines
- Measuring technology

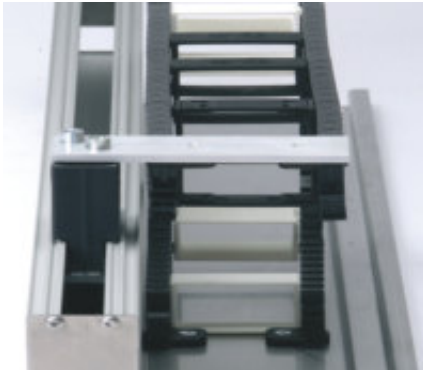

Testing facility at the igus® laboratory System T3 - ideal for high accelerations and short strokes



igus® System T3 T band chain - Inner height 29 mm



Extremely low noise - System T3 tests in the igus® lab showed at 1 m measuring distance: a value of = 33 dB(A) at 26.5 dB(A) basic sound level for Series T3.29.050.038



System T3 | 3-piece E-Chain®



The abbreviation "T3" stands for a T-shaped E band, which consists of three basic elements:

- ❶ 2 side-plate bands (left/right)
- ❷ Separator element incl. separators

System T3 | Assembling



Side plates to be plugged into each other

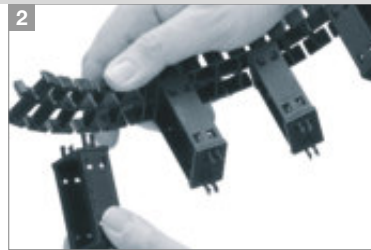

Clip-on "interior separation clips"



System T3 enables quick installation times. The side plates can be simply plugged in

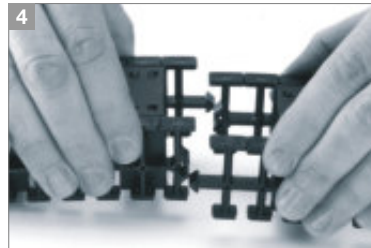

System T3 | Interior Separation | Strain Relief



Separators for dividing the chain cross section from the proven and tested E6 range (E6.29)

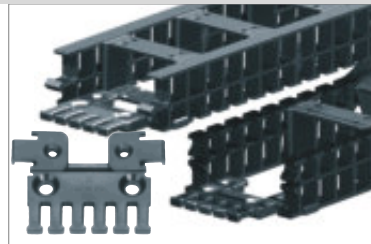

Universal strain relief through optional fixing bracket. You can fix the E-Chain® at the fixed end, if need be





Price index



Extremely low noise  
Test results upon request



Cleanroom test  
upon request

- ① Side plates in one piece
- ② For high speed and high accelerations
- ③ Angle bracket for housing a strain relief tiewrap plate
- ④ 3-piece Design
- ⑤ Easy shortening
- ⑥ Accessories, such as interior separations and strain relief, are available
- ⑦ Low weight
- ⑧ Hardly any polygon effect



Fast assembly due to the side link strip



## When to use the Series T3:

- At very high speeds and/or accelerations
- If a very light E-Chain® is required
- If a particularly low-cost E-Chain® is required
- For small bending radii and small spaces
- If easy filling and assembly is required
- Minimal abrasion  
(e.g. cleanroom applications)



## When not to use it:

- When an E-Chain® is required for more fill weight
- ▶ Series E6.29, page 8.40
- When an enclosed E-Chain® is required for low noise operation
- ▶ Series E6.29, page 8.40



## Order example complete E-Chain®

Please indicate chain-lengths or number of links Example: 1 m or 67 links

1 m E3.29.050.038.0



E-Chain®

with 2 separators E6.29.11 assembled every 2<sup>nd</sup> link

Interior separation

1 set T3.29.030.12



Mounting bracket

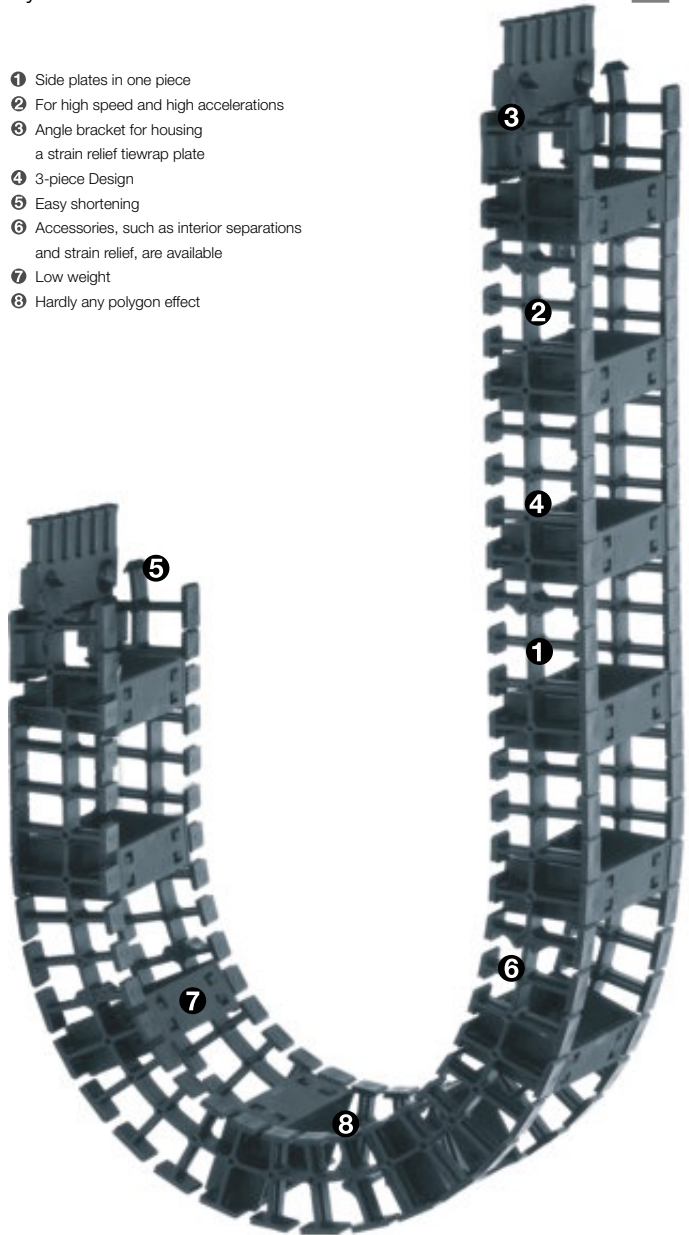

**Unsupported length**

$FL_G$  = with straight upper run

$FL_B$  = with permitted sag

Further information ► Design, page 1.12

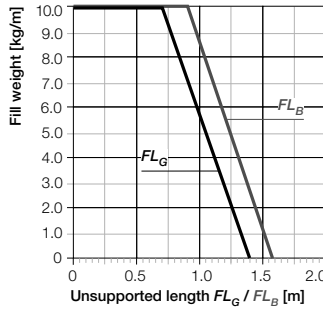
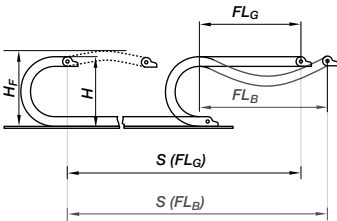

Length of travel S [m]



- $S$  = Length of travel
  - $R$  = Bending radius
  - $H$  = Nominal clearance height
  - $H_F$  = Required clearance height
  - $D$  = Overlength E-Chain® radius in final position
  - $K$  =  $\pi \cdot R$  + "safety"
  - $Z$  = Distance of crossbars
- (Standard: every 4th chain link)

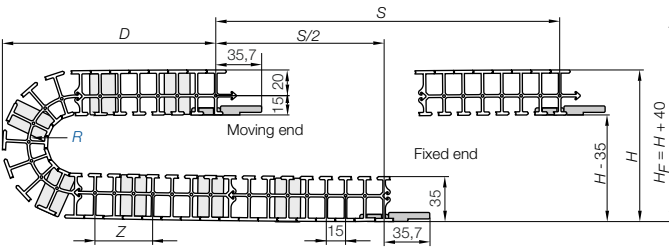

Pitch = 15 mm/Glided Links/m = 67 (1.005 mm) Chain length =  $S/2 + K$

$R$ (min.)	038
$H$ (min.)	116
$D$	103
$K$	150



**Short travels - unsupported**

Unsupported E-Chains® feature positive camber over short travels. This must be accounted for when specifying the clearance height  $H_F$ . Please consult igus® if space is particularly restricted.

The required clearance height:  
 $H_F = H + 40$  mm  
 (with 1,0 kg/m fill weight)

System T3  
Inner height: 29 mm

Phone +49- (0) 22 03-96 49-800  
Fax +49- (0) 22 03-96 49-222



**Chainflex® CF98 - tested 30 million strokes with 4xd**

TPE outer jacket, oil- and bio-oil-resistant, PVC and halogen-free, low-temperature-flexible  
 Further information: [www.igus.de/en/CF98](http://www.igus.de/en/CF98)



Speed / acceleration $FL_G$	max. 20 [m/s] / max. 200 [m/s <sup>2</sup> ]
Speed / acceleration $FL_B$	max. 3 [m/s] / max. 6 [m/s <sup>2</sup> ]
Gliding speed / acceleration (maximum)	upon request
Material - permitted temperature °C	-40° up to +100° C
Flammability class	VDE 0304 IIC UL94 HB

**Technical Data**



Details of material properties  
 ► page 1.38



► page 8.27

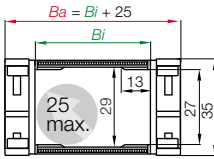

Part No. structure

T3.29.100.038.0

Series T3.29 - with crossbars every 2<sup>nd</sup> link

Part No.	$B_l$ [mm]	$B_a$ [mm]	$R$ [mm]	Bending radii	Weight [kg/m]
T3.29.030.□.0	30	45	038		≈ 0,40
T3.29.040.□.0	40	55	038		≈ 0,42
T3.29.050.□.0	50	65	038		≈ 0,44
T3.29.060.□.0	60	75	038		≈ 0,46
T3.29.070.□.0	70	85	038		≈ 0,48
T3.29.080.□.0	80	95	038		≈ 0,50
T3.29.090.□.0	90	105	038		≈ 0,51
T3.29.100.□.0	100	115	038		≈ 0,53
T3.29.110.□.0	110	125	038		≈ 0,55
T3.29.120.□.0	120	135	038		≈ 0,57

Supplement Part No. with required radius. Example: T3.29.100.038.0

0 = standard color, other colors ► page 1.39 · Pitch = 15 mm/link - Links/m = 67



## Interior separation elements

Distance "Z" for the interior separation elements of the T3 E-Chain®

Note: The first and last chain links should not be stuck with the interior separation elements!

As a standard, crossbars are mounted on every 4th chain link!

Part No. T3.29.100.038.0

For other distances, e.g. every 6th chain link, change the part number as follows:

Part No. T3.29.100.038.Z6.0

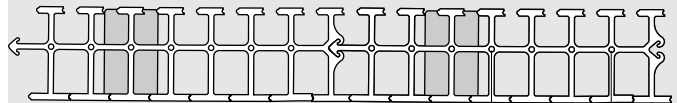

Distance "Z", crossbars mounted on every 4th chain link as standard

Z

### Option 1: Vertical separators

Vertical separators are used if a vertical subdivision of the E-Chain® interior is required -

By standard vertical separators are assembled every 4th E-Chain® link!

- **Standard** subdivision with vertical separator E6.29.11\* (slotted 5 times), for combinations with full-width shelf 111.X
- **Notch separator** E6.29.11.R (slotted 5 times) can be locked in 2 mm increments due to gaps on the crossbars. For side-mounted applications and combinations with full-width shelf 111.X
- **Middle plate\*** E6.29.12 for combinations with side plate E6.29.13, full-width shelf 221.X and shelf 2210.X
- **Strain relief separator** E6.29.12.Z (slotted 5 times), can be integrated into the mounting bracket and can be placed there at any point

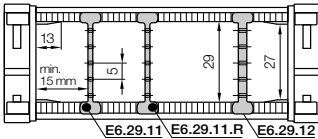

**Vert. separator, slotted\***  
 unassembled E6.29.01  
 assembled E6.29.11

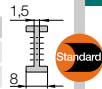

**Notch separator**  
 unassembled E6.29.01.R  
 assembled E6.29.11.R



**Middle plate\***  
 unassembled E6.29.02  
 assembled E6.29.12



**Strain relief separator**  
 unassembled E6.29.02.Z  
 assembled E6.29.12.Z

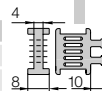

\*no minimum space required!

### Option 2: Full-width shelves

For applications involving many thin cables with similar or identical diameters

- **Full-width shelf 111.X** for combinations with vertical separator E6.29.11 and notch separator E6.29.11.R
- **Full-width shelf 221.X** for combinations with middle plate E6.29.12, strain relief separator E6.29.12.Z, and side plate E6.29.13

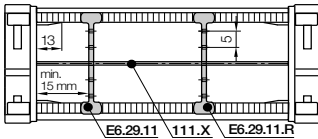

Width X [mm]	Part No. unassembled		Part No. assembled	
	110.X	220.X	111.X	221.X
030	110.30	220.30	111.30	221.30
040	110.40	220.40	111.40	221.40
050	110.50	220.50	111.50	221.50
060	110.60	220.60	111.60	221.60
070	110.70	220.70	111.70	221.70

Width X [mm]	Part No. unassembled		Part No. assembled	
	110.X	220.X	111.X	221.X
080	110.80	220.80	111.80	221.80
090	110.90	220.90	111.90	221.90
100	110.100	220.100	111.100	221.100
110	110.110	220.110	111.110	221.110
120	110.120	220.120	111.120	221.120

**Full-width shelf**

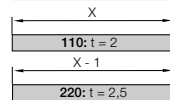

### Option 3: Shelves

Shelves can be arranged elevator-shifted with different bottoms within the entire E-Chain® width

- **Shelf 2210.X** for combinations with middle plate E6.29.12, strain relief separator E6.29.12.Z and side plate E6.29.13

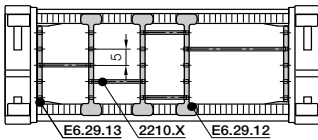

**Side plate**  
 unassembled E6.29.03  
 assembled E6.29.13



Width X [mm]	Part No.	
	unassembled	assembled
18	2200.18	2210.18
23	2200.23	2210.23
28	2200.28	2210.28
33	2200.33	2210.33
38	2200.38	2210.38
43	2200.43	2210.43

Width X [mm]	Part No.	
	unassembled	assembled
48	2200.48	2210.48
58	2200.58	2210.58
68	2200.68	2210.68
73	2200.73	2210.73
88	2200.88	2210.88
99	2200.99	2210.99

**Shelf**

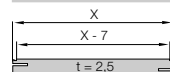

System T3  
 Inner height: 29 mm

Phone +49- (0) 22 03-96 49-800  
 Fax +49- (0) 22 03-96 49-222



▶ page 8.27

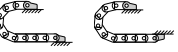
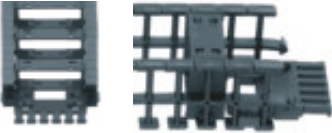

Example: Possible installation conditions for E3 mounting brackets



**Plastic fastener**

- Housing potential for strain relief tiwrap plate
- Firmly attached to the E-Chain®
- Minimized outer width
- Fastening of the E-Chain® possible on subsurface

Moving end  
T3.29...2

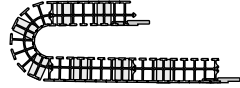

T3.29...1  
Fixed end

**Dimensions and order configurations**



Mounting angle, single

Part No. structure

T3.29. 030. 12



Full set, for both ends:

T3.29. 030. 12

Single-part order:

T3.29. 030. 1

Moving end mounting bracket

T3.29. 030. 2

Mounting end mounting bracket

T3.29...2  
Moving end

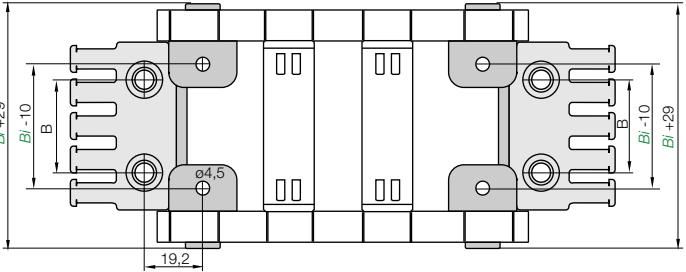

T3.29...1  
Fixed end

For	Part No.	For	Part No.
E-Chain®	full set	E-Chain®	full set
T3.29.030	▶ T3.29.030.12	T3.29.080	▶ T3.29.080.12
T3.29.040	▶ T3.29.040.12	T3.29.090	▶ T3.29.090.12
T3.29.050	▶ T3.29.050.12	T3.29.100	▶ T3.29.100.12
T3.29.060	▶ T3.29.060.12	T3.29.110	▶ T3.29.110.12
T3.29.070	▶ T3.29.070.12	T3.29.120	▶ T3.29.120.12

Tel. +49- (0) 22 03-96 49-800  
Fax +49- (0) 22 03-96 49-222

igus® GmbH  
51147 Cologne

Internet: www.igus.de  
E-mail: info@igus.de

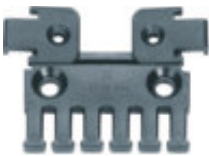

Mounting angle mit strain relief

**igus® Chainfix tiwrap plate as individual part**

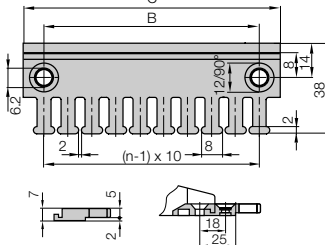

Tiwrap plate	n Number of teeth	Dim. C [mm]	Dim. B [mm]
2020.ZB	3	30	15
2030.ZB	4	40	20
2040.ZB	5	50	30
2050.ZB	6	60	40
2070.ZB	8	80	60
2090.ZB = (2030.ZB + 2040.ZB)	9	90	-
2100.ZB	10	100	80
2125.ZB = (2050.ZB + 2050.ZB)	12	120	-

**Strain relief separator**

Separator with integrated strain relief for the use in the first or last chain link. Individual part for the manufacturing of switchgear cabinets or for the assembly of machines. Easy to assemble without any screws ▶ chapter 10.

Part No.	Number of teeth	For Series
E6.29.02.Z	2 one side	T3.29 E-Chain®

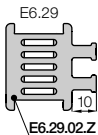

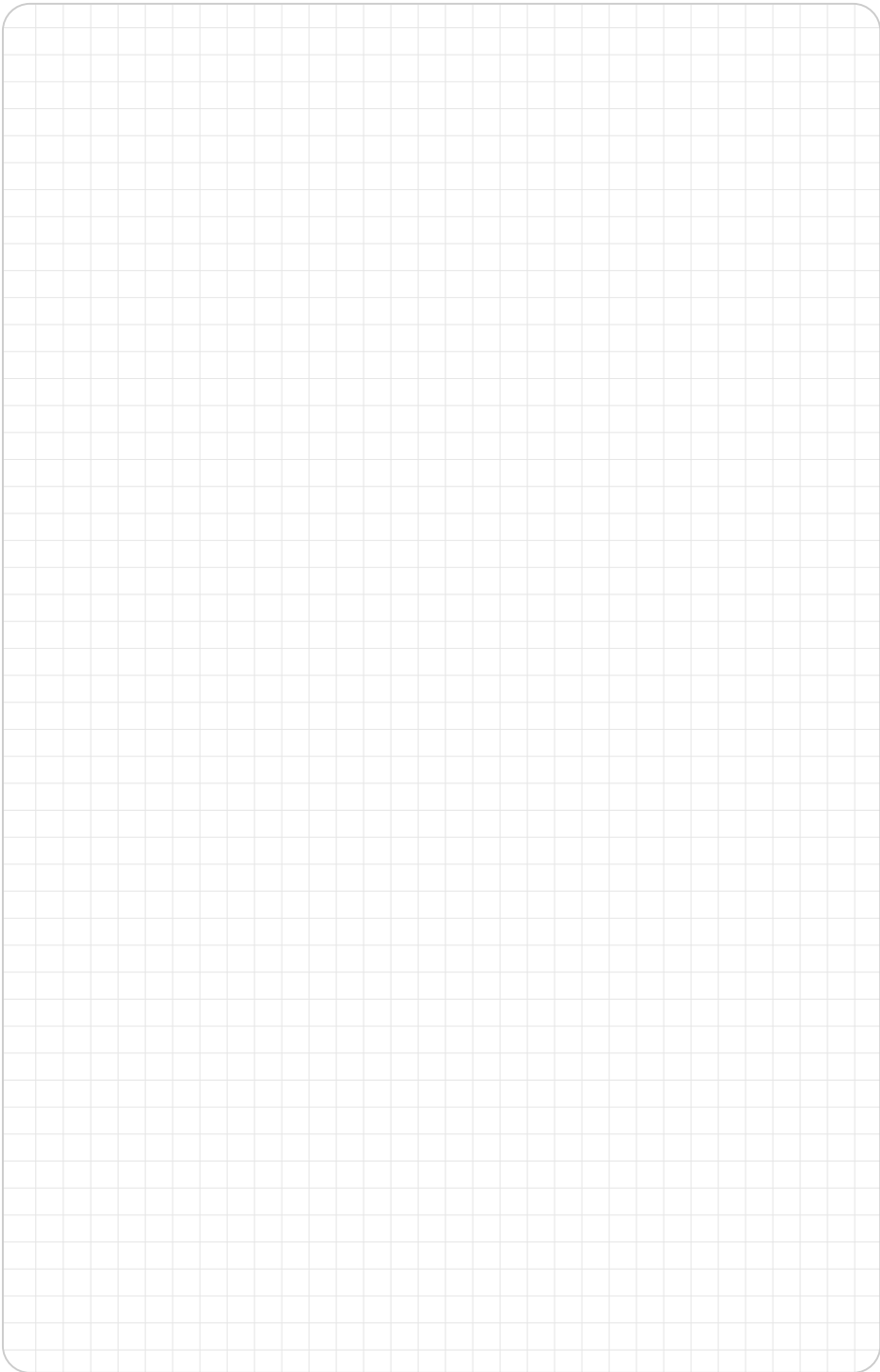

System T3  
Inner height: 29 mm

Tel. +49- (0) 22 03-96 49-800  
Fax +49- (0) 22 03-96 49-222









**E6**

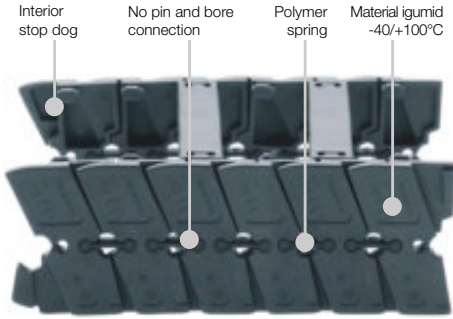

## E6: E-Chain® with 6 pieces per link

- Extremely low-noise operation - 37 dB(A)\* depending on the speed
- Snap-open lids along both radii
- Available as closed tube for some types
- High stability "unsupported"
- For high speed and high accelerations
- Modular design, can be shortened and lengthened
- Minimum vibrations, high stability and tensile strength
- Various interior separations available
- KMA mounting brackets available with integrated strain relief
- E6 adapter link - for gliding applications - minimizes excess lengths in end positions - quick and easy assembly
- You can find more technical data about the material, chemical resistance, temperatures ► **chapter Design, from page 1.38**

### Opening-principle



**E-Chain®:** snap-open along inner and outer radius. **E-Tube:** Lids can be removed along inner and outer radius

### Dimensioning

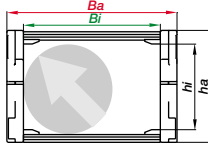

### Bending radius

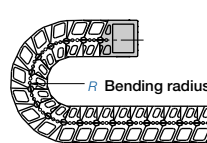

### Part No. structure

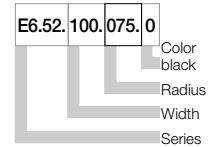

### Selection table

Series	Inner height <i>hi</i> [mm]	Inner width <i>Bi</i> [mm]	Outer width <i>Ba</i> [mm]	Outer height <i>ha</i> [mm]	Bending radius <i>R</i> [mm]	Unsupported length max. [m]	Page
E6.29	29	30 - 120	46 - 136	35	55 - 150	≈ 1,5	8.40
R6.29	28	30 - 120	46 - 136	35	55 - 150	≈ 1,5	8.46
E6.35	35	30 - 120	50 - 140	42	55 - 150	≈ 1,9	8.50
E6.40	40	40 - 300	60 - 320	54	63 - 200	≈ 2,75	8.56
R6.40	40	62	82	54	63 - 200	≈ 2,75	8.62
E6.52	52	40 - 300	64 - 324	65	75 - 250	≈ 3,0	8.66
R6.52	52	40 - 300	64 - 324	65	75 - 250	≈ 3,0	8.72
E6.62	62	50 - 400	86 - 436	84	115 - 350	≈ 4,0	8.76
E6.80L	80	50 - 600	100 - 650	108	150 - 450	≈ 2,5	8.82
E6.80	80	50 - 600	100 - 650	108	150 - 450	≈ 5,25	8.88

### Selected noise tests - External noise corrected measurement values

E-Chain® Series	Averaging of the corrected sound pressure levels	Test method
igus® Series E6.29*	≈ 37 dB(A)	unsupported v = 1,0 m/s
igus® Series E6.52*	≈ 41 dB(A)	unsupported, side mounted v = 0,5 m/s
igus® Series E6.52	≈ 46 dB(A)	unsupported v = 2,0 m/s
Chain 1 Third-party product	≈ 77 dB(A)	unsupported v = 2,0 m/s
Chain 2 Third-party product	≈ 68 dB(A)	unsupported v = 2,0 m/s
Chain 3 Third-party product	≈ 73 dB(A)	unsupported v = 2,0 m/s

Source: TÜV Rheinland \*Source: igus® laboratory



### Noise level ≤ 46 dB(A)

A measurement conducted by the Rhineland Technical Inspection Authority (TÜV Rheinland) in May 2002 indicates a value of ≤ 46 dB(A) at 2 m/s and with an unsupported length of 1.5 m with **Series E6.52.10.100.0**, and all this with at least 10 dB(A) sound pressure level generated by external noise. **We have received an official noise certificate from the Rhineland Technical Inspection Authority (TÜV Rheinland Berlin Brandenburg) and we are happy to provide you with a copy upon request.**

Comparison of the main characteristics

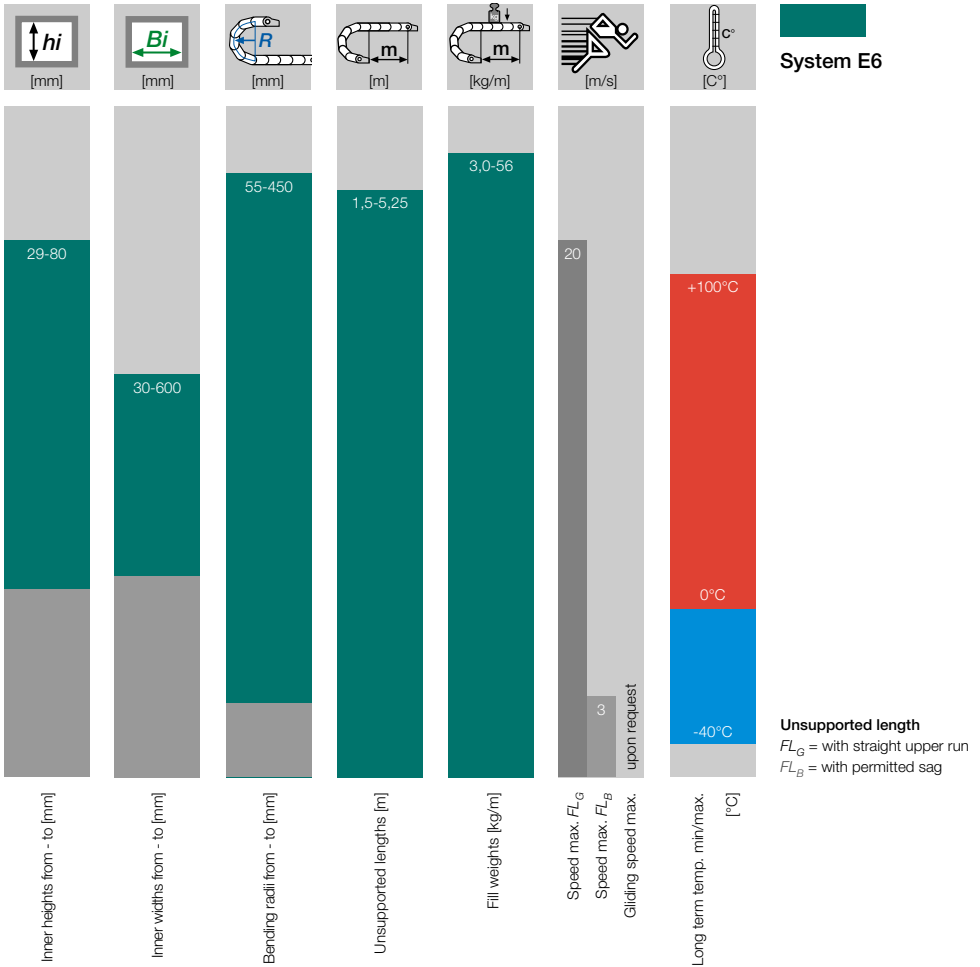

Additional quality features - System E6



Extremely low noise - TÜV certified test. Test variables:  
 $v = 2 \text{ m/s}$   $FL_G = 1,5 \text{ m}$  - Type: E6.52.100.100.0 -  
 External noise: min. 10 dB(A) sound pressure



- IPA Certificate: **ISO Class 1**, according to Norm DIN EN ISO 14644-1 for System E6 - special material "Clean Room", Series E6.29.060.150.0 at  $v = 0,5 \text{ m/s}$ , 2 m/s
- IPA Certificate: **ISO Class 3** (at  $v = 1 \text{ m/s}$  and at  $v = 2 \text{ m/s}$ ) for System E6, Series E6.29.050.055.0



ATEX-ESD Standard Material: igumid G - ESD compatibility  
 Level 1 according to SEMI E78-0998 ESD igumid ESD special material (upon request): Superior long-term conductivity due to lack of pin and bore toleranas (no air gaps)



System E6 - 6-piece link-design

The abrasion resistant connector strips are replacing the common pin and bore connection. Therefore the E6 is suitable for **clean room applications**, tested by the IPA Fraunhofer institute, ISO Class 3 (Acc. DIN EN ISO 14644-1 for Series E6.29.050.055.0 - for  $v = 1$  m/s and  $v = 2$  m/s). The special design of the chain links and the small pitches are responsible for the **low-noise operation** of the System E6. A test of the TÜV Rheinland in May 2002 came to the result of 46dB(A) at a minimum noise pressure level of 10dB(A) caused by exterior noise (Velocity 2 m/s, 1,5 m unsupported, Series E6.52.100.100.0, 10dB(A) external noise). Another advantage of the connector strips is that they can guarantee a long-term conductivity, if electric conductive special material is used (igumid ESD on demand). We already have the following classification for the standard material igumid G: **ESD-compatibility LEVEL 1** acc. SEMI E78-0998 for Series E6.29.050.055.0

### Typical industries & applications

- Cleanroom ● Printing machines ● Handling & robot ● Machine Tools ● Measuring machines ● Semiconductor industries ● Medical industries ● Electronic industries ● General machinery



TÜV noise certificate states 46 dB(A)



Nested E-Chains® reduce vibrations and improve milling accuracy Series E6.62



Noise test in the igus® laboratory 40db(A)  
E.6.29.100.100.0 series for long travel paths,  $v = 2$  m/s



Series E6.52.050.100.0 to carry very fast electric cables and ink hoses in a digital printer, but also had to be extremely quiet and silent. Fillweight: 2 kg,  $v = 2$  m/s,  $a = 20$  m/s<sup>2</sup>, cycles per day: 6000



Series E6.52.150.150.0 in a pick and place robot. Handles injection molded CD covers in a split second: Tool open gripper in....tool closed - all in 0.25 seconds, speed 8m/s, acceleration: 78,5 m/s<sup>2</sup>



System E6 | E-Chain® | **Assembling**



1 Position side links...



2 ... gently twist and snap in



3 Gently reinsert connector by using hammer



4 Position crossbars, push down and snap in

E-Tube | **Assembling lids**



1 Insert lid...



2 ...push down and snap in

System E6 | E-Chain® | **Separating**



1 Lever crossbars with screwdriver



2 Tap gently to remove connectors



3 Twist and...



4 ...separate side links

E-Tube | **Separating lids**



1 Lever with screwdriver...



2 ...and remove lids by hand



You can find an assembly video on the web ► [www.igus.de/en/e6\\_assembly](http://www.igus.de/en/e6_assembly)



Price index



Extremely low noise  
Test results upon request



IPA certification: ISO Class 1, acc. to norm DIN EN ISO 14644-1 for the System E6 - Special material "cleanroom", Series E6.29.060.150.0 at  $v = 0,5$  m/s, 2 m./s. ISO Class 3 (at  $v = 1$  m/s and  $v = 2$  m/s) for the system E6, Series E6.29.050.055.0



ATEX-ESD Standard Material: igumid G - ESD compatibility Level 1 according to SEMI E78-0998 ESD igumid ESD special material (upon request): Superior long-term conductivity due to lack of pin and bore tolerances (no air gaps)



To close, push and click shut



When to use the Series E6.29:

- If a low-noise version is required
- At very high speeds and/or accelerations
- For enlarged thrusts and tensile forces
- For small bending radii
- If less vibration is required
- Minimal abrasion  
(e.g. cleanroom applications)



When not to use it:

- Limited in side-mounted applications  
▶ Series 2400/2500 System E2/000, page 5.94
- No use with RBR (reverse bending radius)  
▶ Series 2400/2500 System E2/000, page 5.94
- No use with high additional loads  
▶ Series 2400/2500 System E2/000, page 5.94
- No use in dirty environments  
▶ Series 2400/2500 System E2/000, page 5.94

- ① No pin and bore connection
- ② Small pitch for low-noise, smooth operation
- ③ Very large gliding surfaces
- ④ Can be shortened or lengthened due to modular design
- ⑤ Increased inner height
- ⑥ Interior stop dog
- ⑦ KMA mounting brackets with attachment points on all sides (strain relief with separate tiewrap plates possible)
- ⑧ Strain relief separator - E6.29.02.Z separator with integrated strain relief for the use in the first or last chain link ▶ page 8.44

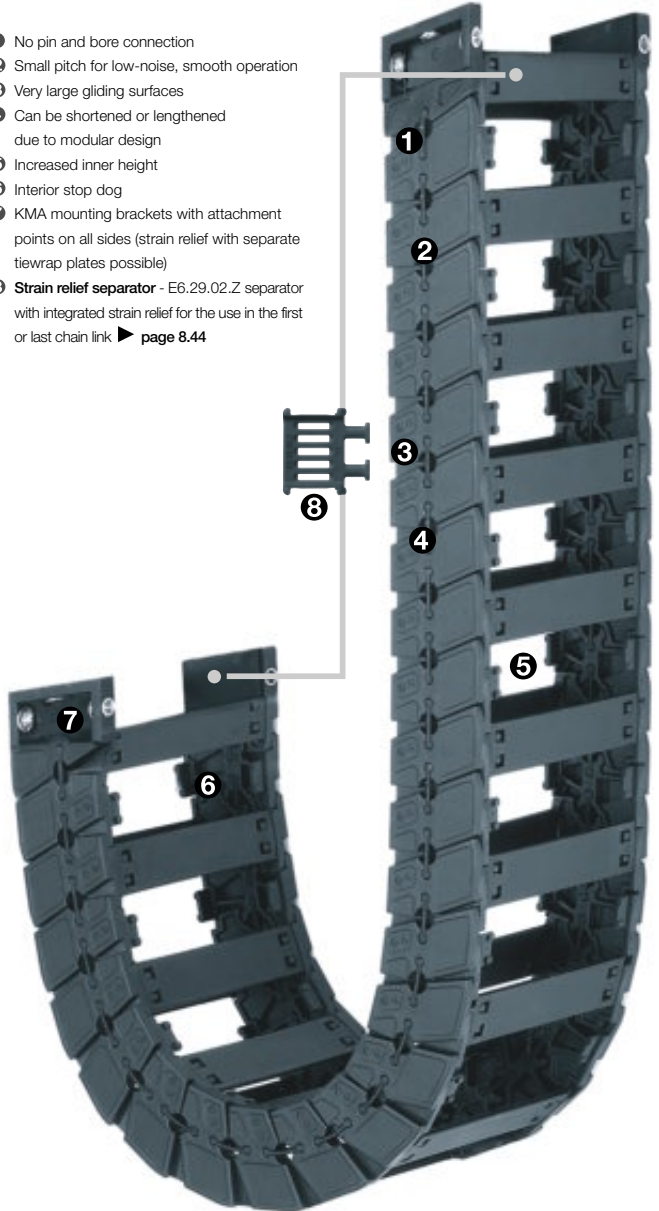

Order example complete E-Chain®

Please indicate chain-lengths or number of links Example: 2 m or 92 links

2 m E6.29.100.075.0



E-Chain®

with 2 separators E6.29.11 assembled every 2<sup>nd</sup> link

Interior separation

1 set E6.290.100.12



Mounting bracket



**Unsupported length**

$FL_G$  = with straight upper run

$FL_B$  = with permitted sag

Further information ► **Design, page 1.12**

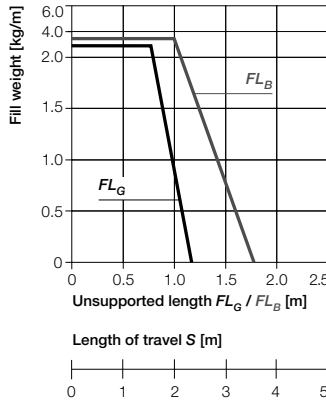
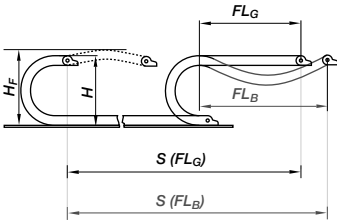

- $S$  = Length of travel
- $R$  = Bending radius
- $H$  = Nominal clearance height
- $H_f$  = Required clearance height
- $D$  = Overlength E-Chain® radius in final position
- $K = \pi \cdot R + \text{"safety"}$

**Other installation methods**

- Vertical, hanging  $\leq 30$  m
- Vertical, standing  $\leq 2$  m
- Side mounted, unsupported = possible to a limited extent
- Unsupported length of upper run = upon request



**Short travels - unsupported**

Unsupported E-Chains® feature positive camber over short travels. This must be accounted for when specifying the clearance height  $H_f$ . Please consult igus® if space is particularly restricted.

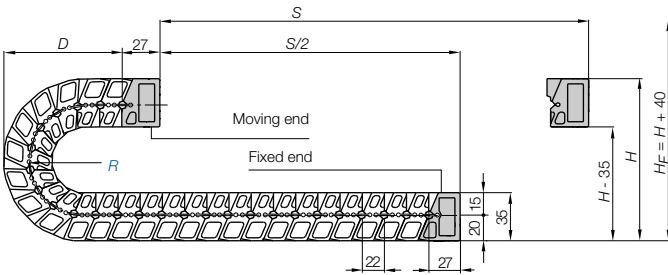

**Pitch = 22 mm/link Links/m = 46 (1012 mm) Chain length =  $S/2 + K$**

$R$	055	075	100	150
$H$ (min.)	150	190	240	340
$D$	97	117	142	192
$K$	220	280	360	520

The required clearance height:  
 $H_f = H + 40$  mm  
 (with 2,0 kg/m fill weight)

29

System E6  
Inner height: 29 mm

Phone +49- (0) 22 03-96 49-800  
Fax +49- (0) 22 03-96 49-222



► page 8.39

**The FOC-cable for more than 30 Mio. cycles - Chainflex® CFLG.2H**

PUR-outer jacket, halogen-free, metal-free  
 Further information: [www.igus.de/en/CFLG.2H](http://www.igus.de/en/CFLG.2H)

CHAINFLEX® CFLG.2H

TIP!

Speed / acceleration $FL_G$	max. 20 [m/s] / max. 200 [m/s <sup>2</sup> ]
Speed / acceleration $FL_B$	max. 3 [m/s] / max. 6 [m/s <sup>2</sup> ]
Gliding speed / acceleration (maximum)	upon request
permitted temperature °C	-40° up to +100° C
Flammability class	VDE 0304 IIC UL94 HB

**Technical Data**

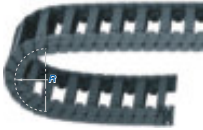
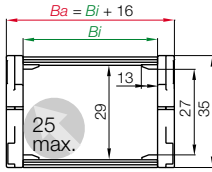

Details of material properties  
 ► page 1.38

Series E6.29 - with crossbars every 2<sup>nd</sup> link

Part No.	<i>Bj</i> [mm]	<i>Ba</i> [mm]	<i>R</i> [mm]	Bending radii		Weight [kg/m]
E6.29.030.□.0	30	46	055	075	100 150	≈ 0,73
E6.29.040.□.0	40	56	055	075	100 150	≈ 0,75
E6.29.050.□.0	50	66	055	075	100 150	≈ 0,78
E6.29.060.□.0	60	76	055	075	100 150	≈ 0,80
E6.29.070.□.0	70	86	055	075	100 150	≈ 0,83
E6.29.080.□.0	80	96	055	075	100 150	≈ 0,85
E6.29.090.□.0	90	106	055	075	100 150	≈ 0,88
E6.29.100.□.0	100	116	055	075	100 150	≈ 0,90
E6.29.110.□.0	110	126	055	075	100 150	≈ 0,93
E6.29.120.□.0	120	136	055	075	100 150	≈ 0,95

\*upon request

Supplement Part No. with required radius. Example: E6.29.100.□.0

0 = standard color, other colors ▶ page 1.39 · Pitch = 22 mm/link - Links/m = 46

Part No. structure

E6.29.100.100.0



## Part No. E-Chain® - links, single parts

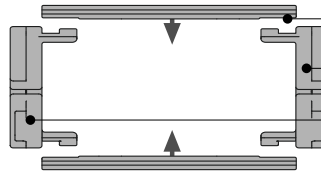

Single crossbar, Part No. 2105.Bi

Right side link\*, single part, Part No. E6.29.□.R□.02

Left side link\*, single part, Part No. E6.29.□.R□.01

\*View from the fixed point



Long travel and side mounted installation with the vibration-free and low noise serie E6.29 in this camera application

### Option 1: Vertical separators

Vertical separators are used if a vertical subdivision of the E-Chain® interior is required -

By standard vertical separators are assembled every other E-Chain® link

- **Standard** subdivision with **vertical separator E6.29.11\*** (slotted 5 times), for combinations with **full-width shelf 111.X**
- **Notch separator E6.29.11.R** (slotted 5 times) can be locked in 2 mm increments due to gaps on the crossbars. For side-mounted applications and combinations with **full-width shelf 111.X**
- **Middle plate\* E6.29.12** (slotted 5 times) for combinations with **side plate E6.29.13**, **full-width shelf 221.X** and **Shelf 2210.X**
- **Strain relief separator E6.29.12.Z** (slotted 5 times), can be integrated into the mounting bracket and can be placed there at any point

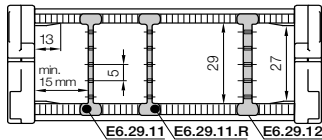

<b>Vert. separator, slotted*</b>	
unassembled	E6.29.01
assembled	E6.29.11

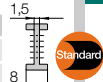

<b>Notch separator</b>	
unassembled	E6.29.01.R
assembled	E6.29.11.R



<b>Middle plate*</b>	
unassembled	E6.29.02
assembled	E6.29.12



<b>Strain relief separator</b>	
unassembled	E6.29.02.Z
assembled	E6.29.12.Z

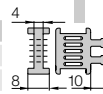

\*no minimum space required!

### Option 2: Full-width shelves

For applications involving many thin cables with similar or identical diameters

- **Full-width shelf 111.X** for combinations with **vertical separator E6.29.11** and **notch separator E6.29.11.R**
- **Full-width shelf 221.X** for combinations with **middle plate E6.29.12**, **strain relief separator E6.29.12.Z**, and **side plate E6.29.13**

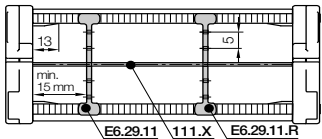

Width X [mm]	Part No. unassembled 110.X	Part No. assembled 220.X	Part No. assembled 111.X	Part No. assembled 221.X
030	110.30	220.30	111.30	221.30
040	110.40	220.40	111.40	221.40
050	110.50	220.50	111.50	221.50
060	110.60	220.60	111.60	221.60
070	110.70	220.70	111.70	221.70

Width X [mm]	Part No. unassembled 110.X	Part No. assembled 220.X	Part No. assembled 111.X	Part No. assembled 221.X
080	110.80	220.80	111.80	221.80
090	110.90	220.90	111.90	221.90
100	110.100	220.100	111.100	221.100
110	110.110	220.110	111.110	221.110
120	110.120	220.120	111.120	221.120

**Full-width shelf**

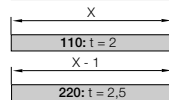

### Option 3: Shelves

Shelves can be arranged elevator-shifted with different bottoms within the entire E-Chain® width

- **Shelf 2210.X** for combinations with **middle plate E6.29.12**, **strain relief separator E6.29.12.Z**, and **side plate E6.29.13**

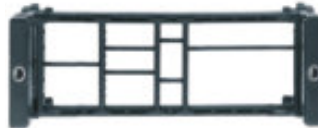
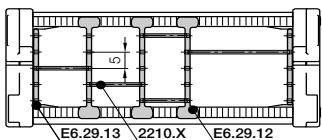

Width X [mm]	Part No. unassembled	Part No. assembled
18	2200.18	2210.18
23	2200.23	2210.23
28	2200.28	2210.28
33	2200.33	2210.33
38	2200.38	2210.38
43	2200.43	2210.43

Width X [mm]	Part No. unassembled	Part No. assembled
48	2200.48	2210.48
58	2200.58	2210.58
68	2200.68	2210.68
73	2200.73	2210.73
88	2200.88	2210.88
99	2200.99	2210.99

**Side plate, slotted**

unassembled	E6.29.03
assembled	E6.29.13



**Shelf**

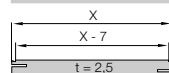

System E6  
Inner height: 29 mm

Phone +49- (0) 22 03-96 49-800  
Fax +49- (0) 22 03-96 49-222



▶ page 8.39



\* KMA = Polymer Metal Mounting Bracket

Moving end  
E6.290...2

### Option KMA\* - pivoting

- Bolted connection outside of chain cross-section
- Recommended for unsupported applications (for gliding applications please contact igus®)
- Confined installation conditions
- Universal mountable with attachment capability on all sides

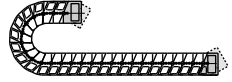

The attachment variants arising automatically by the choice of the KMA mounting bracket

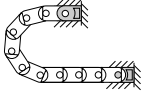

E6.290...1  
Fixed end

## Dimensions and order configurations

E6.290...2

Fixed end

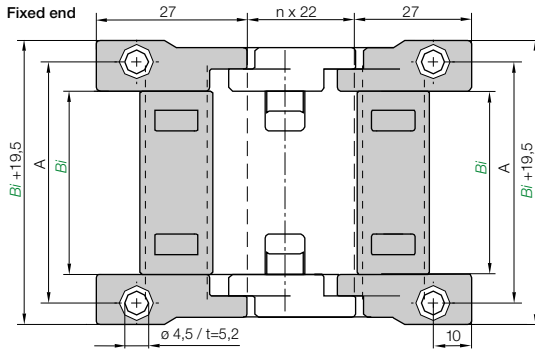

E6.290...1

Moving end

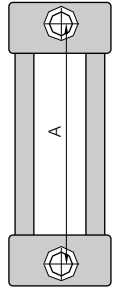

### Part No. structure

E6.290.030.12



Full set, for both ends:

[E6.290.030.12](#)

Single-part order:

[E6.290.030.1](#)

Fixed end mounting bracket

[E6.290.030.2](#)

Moving end mounting bracket

For	Part No.	Dim. A
E-Chain®	full set	[mm]
E6.29.030	▶ E6.290.030.12	40
E6.29.040	▶ E6.290.040.12	50
E6.29.050	▶ E6.290.050.12	60
E6.29.060	▶ E6.290.060.12	70
E6.29.070	▶ E6.290.070.12	80

For	Part No.	Dim. A
E-Chain®	full set	[mm]
E6.29.080	▶ E6.290.080.12	90
E6.29.090	▶ E6.290.090.12	100
E6.29.100	▶ E6.290.100.12	110
E6.29.110	▶ E6.290.110.12	120
E6.29.120	▶ E6.290.120.12	130

Phone +49- (0) 22 03-96 49-800  
Fax +49- (0) 22 03-96 49-222

igus® GmbH  
51147 Cologne

Internet: [www.igus.de](http://www.igus.de)  
E-mail: [info@igus.de](mailto:info@igus.de)



Other strain relief elements - optional ▶ chapter 10

## System E6 | E-Chain® | Series E6.29 | Accessories | Strain Relief

### igus® Chainfix tiwrap plate as individual part

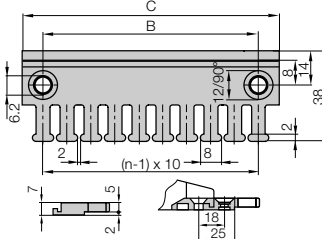

Tiewrap plate	n Number of teeth	Dim. C [mm]	Dim. B [mm]
2020.ZB	3	30	15
2030.ZB	4	40	20
2040.ZB	5	50	30
2050.ZB	6	60	40
2070.ZB	8	80	60
2090.ZB = (2030.ZB + 2040.ZB)	9	90	-
2100.ZB	10	100	80
2125.ZB = (2050.ZB + 2050.ZB)	12	120	-

### Strain relief separator

Separator with integrated strain relief for the use in the first or last chain link. Individual part for the manufacturing of switchgear cabinets or for the assembly of machines. Easy to assemble without any screws ▶ chapter 10.

Part No.	Number of teeth	For Series
E6.29.02.Z	2 one side	E6.29 E-Chain®

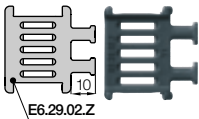

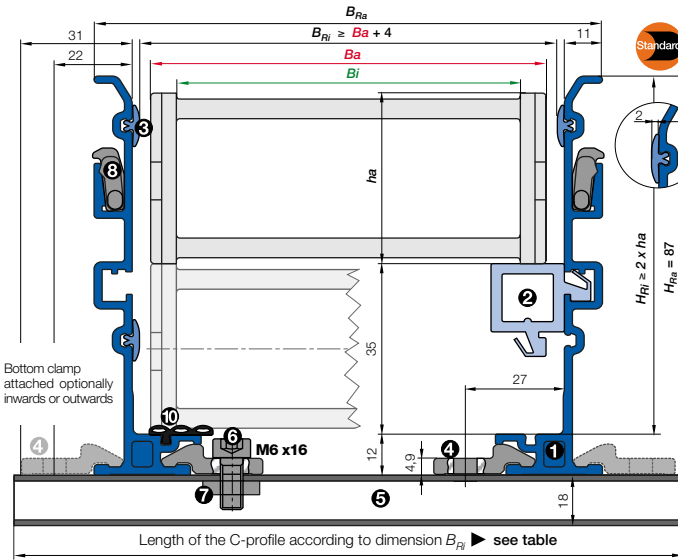

- $B_a$  = Outer width E-Chains\* / E-Tube
- $B_i$  = Inner width E-Chains\* / E-Tube
- $h_a$  = Outer height E-Chains\* / E-Tube
- $H_{Ri}$  = Inner trough height
- $H_{Ra}$  = Outer trough height
- $B_{Ri}$  = Inner trough width ► depends on dim.  $B_a$
- $B_{Ra}$  = Outer trough width
- $n_{Mon}$  = Number of installation sets (left/right)
- $n_{Ri}$  = Number of trough sets (left/right)
- $H_{Ri} \geq 2 \cdot h_a$   
 $B_{Ri} \geq B_a + 4$
- = Guide trough set      ● = Glide bar
- = Installation set "Basic"      ● = C-profile

**Installation set "Basic" with C-profile**

Bottom Clamp attached optionally inwards or outwards

E6.29.030.100.0 ► Order example

$B_{Ri}$ [mm]	Part No.	
	attached inwards	attached outwards
.030 50	-	960.30.150
.040 60	-	960.30.175
.050 70	-	960.30.175
.060 80	960.30.150	960.30.175
.070 90	960.30.150	960.30.200
.080 100	960.30.150	960.30.200
.090 110	960.30.175	960.30.225
.100 120	960.30.175	960.30.225
.110 130	960.30.200	960.30.225
.120 140	960.30.200	960.30.250

Insert for the installation set "Heavy-Duty": **971.50.XXX** instead of (960.30.XXX) on the right column "attached outwards"



- **Components, trough "Basic":** ① Trough side parts, aluminum, 2 m ② Glide bar, plastic, 2 m ③ Glide strips, plastic, 2 m (without glide strips on request) ⑩ Optional: Silencer profile, rubber
- **Components, installation set "Basic":** ④ Bottom clamp, aluminum ⑤ C-profile, steel galvanized ⑥ Screw M6 x16 ⑦ Sliding nut M6 ⑧ Interface connector, plastic

**Order example: Length of travel 30 m - Center mounted for Series E6.29.060.100.0 with  $B_{Ri} = 80$**

Guide trough set (set of 2 trough side parts, incl. glide strips) <b>without</b> glide bar	Part No.	971.30.SL
Order text: 16 m guide trough without glide bar (8 x 2 m sections)		
Guide trough set (set of 2 trough side parts, incl. glide strips) <b>with</b> glide bar	Part No.	971.31.SL
Order text: 16 m guide trough with glide bar (8 x 2 m sections)		
Installation set "Basic" complete (guide trough-sets + 1)	Part No.	960.30.150
Order text: 17 installation sets "Basic"		
Module for the fixed end	Part No.	971.80
Order text: 1 set		
Option: For an additional noise dampening with silencer profile, please add Index A - Example:	Part No.	971.30.SLA

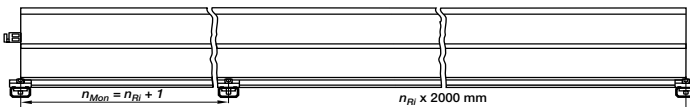

Principle sketch: Number of installation sets to be installed = **Number of trough sections + 1**

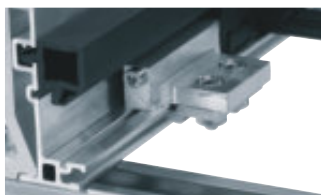

**NEW! A quick fix for mounting the stationary end of an E-Chain\***

With this new module for the fixed end, fast and easy mounting onto the Aluminum "SuperTrough" is now possible without any drilling. Fast mounting of the E-Chain\* by clamping onto the aluminum trough

- Quick relocation of the stationary end
- No drilling necessary ► page 9.16





Price index



Extremely low noise  
Test results upon request



IPA certification: ISO Class 1, acc. to norm DIN EN ISO 14644-1 for the System E6 - Special material "cleanroom", Series E6.29.060.150.0 at  $v = 0,5$  m/s, 2 m./s. ISO Class 3 (at  $v = 1$  m/s and  $v = 2$  m/s) for the system E6, Series E6.29.050.055.0



ATEX-ESD Standard Material: igumid G - ESD compatibility Level 1 according to SEMI E78-0998 ESD igumid ESD special material (upon request); Superior long-term conductivity due to lack of pin and bore toleranus (no air gaps)

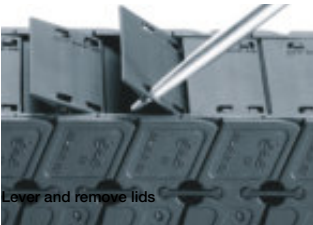

Lever and remove lids



When to use the Series R6.29:

- If a low-noise version is required
- At very high speeds and/or accelerations
- Protection against dirt and chips
- For small bending radii
- If less vibration is required
- Minimal abrasion  
(e.g. cleanroom applications)



When not to use it:

- Limited in side-mounted applications
  - ▶ Series 2450/2480 System E2/000, page 5.94
- No use with RBR (reverse bending radius)
  - ▶ Series 2450/2480 System E2/000, page 5.94
- No use with high additional loads
  - ▶ Series 2450/2480 System E2/000, page 5.94

- 1 Fully enclosed E-Tube
- 2 No pin and bore connection
- 3 Can be shortened or lengthened due to modular design
- 4 Very large gliding surfaces
- 5 Interior stop dog
- 6 Small pitch for low-noise, smooth operation
- 7 KMA mounting brackets with attachment points on all sides (strain relief with separate tiewrap plates possible)
- 8 Enclosed design protects from light debris, weld splatter and compromising environmental influences

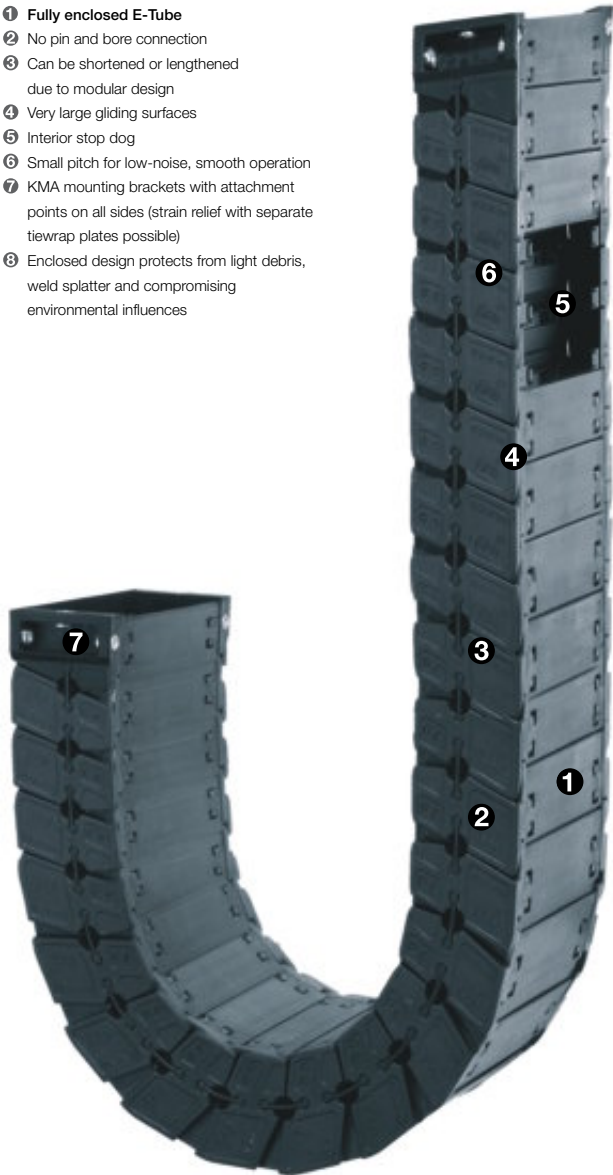

Order example complete E-Chain®

Please indicate chain-lengths or number of links Example: 2 m or 92 links

2 m R6.29.080.100.0



E-Tube

with 2 separators R6.29.11 assembled every 2<sup>nd</sup> link

Interior separation

1 set R6.290.080.12



Mounting bracket

**Unsupported length**

$FL_G$  = with straight upper run

$FL_B$  = with permitted sag

Further information ► **Design, page 1.12**

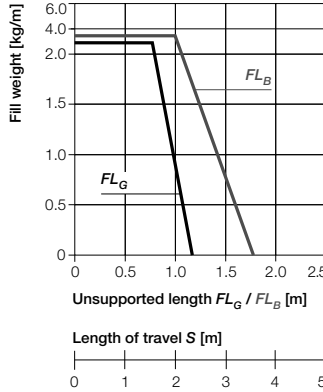
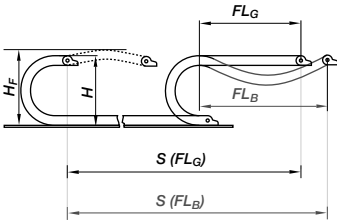

- $S$  = Length of travel
- $R$  = Bending radius
- $H$  = Nominal clearance height
- $H_F$  = Required clearance height
- $D$  = Overlength E-Chain\* radius in final position
- $K = \pi \cdot R + \text{"safety"}$

**Other installation methods**

- Vertical, hanging  $\leq 30$  m
- Vertical, standing  $\leq 2$  m
- Side mounted, unsupported = possible to a limited extent
- Unsupported length of upper run = upon request



**Short travels - unsupported**

Unsupported E-Chains\* feature positive camber over short travels. This must be accounted for when specifying the clearance height  $H_F$ . Please consult igus\* if space is particularly restricted.

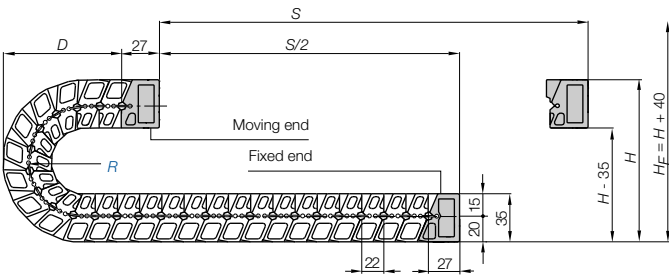

Pitch = 22 mm/link Links/m = 46 (1012 mm) Chain length =  $S/2 + K$

R	055	075	100	150
H (min.)	150	190	240	340
D	97	117	142	192
K	220	280	360	520

The required clearance height:  
 $H_F = H + 40$  mm  
 (with 2,0 kg/m fill weight)

**Bio-oil-resistant TPE-bus cables in machine tools - Chainflex® CF11.LC.D**

TPE outer jacket, shielded, PVC- and halogen-free  
 Further information: [www.igus.de/en/CF11LCD](http://www.igus.de/en/CF11LCD)

CHAINFLEX® CF11.LC.D



TIP!

Speed / acceleration $FL_G$	max. 20 [m/s] / max. 200 [m/s <sup>2</sup> ]
Speed / acceleration $FL_B$	max. 3 [m/s] / max. 6 [m/s <sup>2</sup> ]
Gliding speed / acceleration (maximum)	upon request
permitted temperature °C	-40° up to +100° C
Flammability class	VDE 0304 IIC UL94 HB

**Technical Data**



Details of material properties  
 ► page 1.38

28

System E6  
 Inner height: 28 mm

Phone +49- (0) 22 03-96 49-800  
 Fax +49- (0) 22 03-96 49-222



Trough E6.29  
 ► page 8.45



► page 8.39



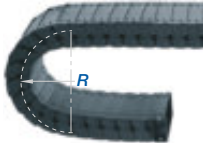
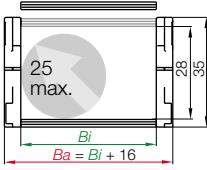

Series R6.29 - E-Tube, lids can be removed along inner and outer radius

Part No.	Bi [mm]	Ba [mm]	R [mm]	Bending radii	Weight [kg/m]
R6.29.030.□.0	30	46	055	075 100 150	≈ 0,80
R6.29.050.□.0	50	66	055	075 100 150	≈ 0,89
R6.29.060.□.0	60	76	055	075 100 150	≈ 0,94
R6.29.080.□.0	80	96	055	075 100 150	≈ 1,03
R6.29.100.□.0	100	116	055	075 100 150	≈ 1,13
R6.29.110.□.0	110	126	055	075 100 150	≈ 1,18
R6.29.120.□.0	120	136	055	075 100 150	≈ 1,22

Part No. structure

R6.29.060.100.0



Supplement Part No. with required radius. Example: R6.29.080.100.0

0 = standard color, other colors ▶ page 1.39 · Pitch = 22 mm/link - Links/m = 46

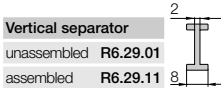

System E6 | E-Tube | Series R6.29 | Accessories | Interior Separation

Option 1: Vertical separators

Vertical separators are used if a vertical subdivision of the E-Chain® interior is required -  
 By standard vertical separators are assembled every other E-Chain® link!

- The notches on this separator marks the sticking side for a stuck mounting on the lid
- Standard subdivision with vertical separator E6.29.11

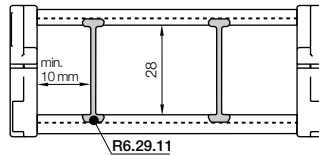
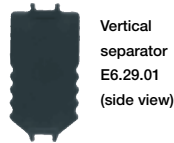

igus® System E6 in industrial printing machines - low noise and less vibrations are some of the benefits of the System E6

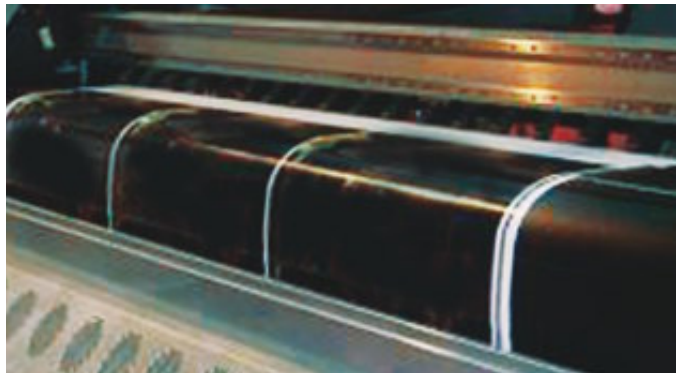





Price index



Extremely low noise  
Test results upon request



Cleanroom test  
upon request



ATEX-ESD Standard Material: igumid G  
- ESD compatibility Level 1 according to SEMI E78-0998 ESD igumid ESD special material (upon request); Superior long-term conductivity due to lack of pin and bore tolerances (no air gaps)



To close, push and click shut



When to use the Series E6.35:

- If a low-noise version is required
- At very high speeds and/or accelerations
- For enlarged thrusts and tensile forces
- For small bending radii
- If less vibration is required
- Minimal abrasion  
(e.g. cleanroom applications)



When not to use it:

- Limited in side-mounted applications  
▶ Series 280/290 System E4, page 7.26
- No use with RBR (reverse bending radius)  
▶ Series 280/290 System E4, page 7.26
- No use with high additional loads  
▶ Series 280/290 System E4, page 7.26
- No use in dirty environments  
▶ Series 280/290 System E4, page 7.26
- If a fully enclosed E-Tube is required  
▶ Series R58 E2 Tubes, page 6.34

- ① No pin and bore connection, minimal abrasion
- ② Small pitch for low-noise, smooth operation
- ③ Very large gliding surfaces
- ④ Interior stop dog
- ⑤ KMA mounting brackets with attachment points on all sides (strain relief with separate tie-wrap plates possible)
- ⑥ Can be shortened or lengthened due to modular design
- ⑦ **Strain relief separator** - E6.35.02.Z separator with integrated strain relief for the use in the first or last chain link ▶ page 8.54

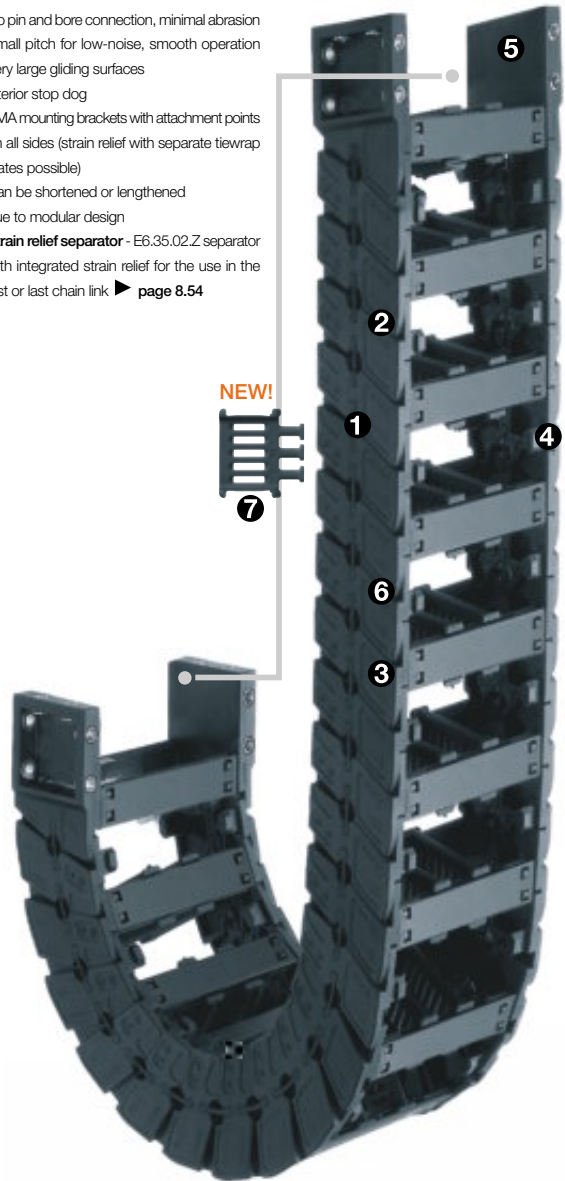

Order example complete E-Chain®

Please indicate chain-lengths or number of links Example: 2 m or 80 links

2 m E6.35.100.055.0



E-Chain®

with 2 separators E6.35.01 assembled every 2<sup>nd</sup> link



Interior separation

1 set E6.350.100.12



Mounting bracket

**Unsupported length**

$FL_G$  = with straight upper run

$FL_B$  = with permitted sag

Further information ► **Design, page 1.12**

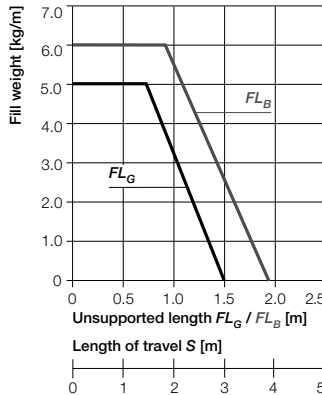
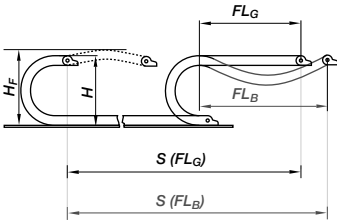

- $S$  = Length of travel
- $R$  = Bending radius
- $H$  = Nominal clearance height
- $H_F$  = Required clearance height
- $D$  = Overlength E-Chain® radius in final position
- $K = \pi \cdot R + \text{"safety"}$

**Other installation methods**

- Vertical, hanging  $\leq 30$  m
- Vertical, standing  $\leq 2$  m
- Side mounted, unsupported = possible to a limited extent
- Unsupported length of upper run = upon request

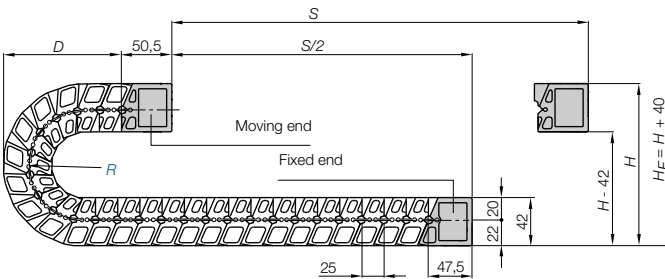

**Pitch = 25 mm/link Links/m = 40 (1.000 mm) Chain length =  $S/2 + K$**

$R$	055
$H$ (min.)	154
$D$	102
$K$	225

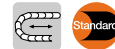

**Short travels - unsupported**

Unsupported E-Chains® feature positive camber over short travels. This must be accounted for when specifying the clearance height  $H_F$ . Please consult igus® if space is particularly restricted.

The required clearance height:  
 $H_F = H + 40$  mm  
 (with 2,0 kg/m fill weight)

35

System E6  
Inner height: 35 mm

Phone +49- (0) 22 03-96 49-800  
Fax +49- (0) 22 03-96 49-222



► page 8.39

**Double shielded data-cable for highest EMV-safety - Chainflex® CF12**

**TIP!**

TPE-outer jacket, double shielded, oil- and biooilresistant, PVC- and halogen-free  
 Further information: [www.igus.de/en/CF12](http://www.igus.de/en/CF12)

IGUS® CHAINFLEX® CF12

Speed / acceleration $FL_G$	max. 20 [m/s] / max. 200 [m/s²]
Speed / acceleration $FL_B$	max. 3 [m/s] / max. 6 [m/s²]
Gliding speed / acceleration (maximum)	upon request
Material - permitted temperature °C	-40° up to +100° C
Flammability class	VDE 0304 IIC UL94 HB

**Technical Data**



Details of material properties  
 ► page 1.38

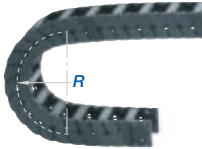
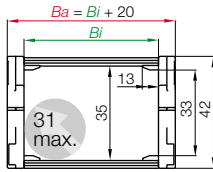

Part No. structure

E6.35.100.055.0

Series E6.35 - with crossbars every 2<sup>nd</sup> link

Part No.	Bl [mm]	Ba [mm]	R [mm]	Bending radii	Weight [kg/m]
E6.35.030.□.0	30	50	055		≈ 0,88
E6.35.040.□.0	40	60	055		≈ 0,90
E6.35.050.□.0	50	70	055		≈ 0,92
E6.35.060.□.0	60	80	055		≈ 0,94
E6.35.070.□.0	70	90	055		≈ 0,96
E6.35.080.□.0	80	100	055		≈ 0,99
E6.35.090.□.0	90	110	055		≈ 1,01
E6.35.100.□.0	100	120	055		≈ 1,03
E6.35.110.□.0	110	130	055		≈ 1,05
E6.35.120.□.0	120	140	055		≈ 1,07

The bending radii **075** **100** **125** **150** are available upon request.

Delivery time: approx. 6-8 weeks after receipt of order!

Supplement Part No. with required radius. Example: E6.35.100.**055**.0

0 = standard color, other colors ▶ page 1.39 · Pitch = 25 mm/link - Links/m = 40

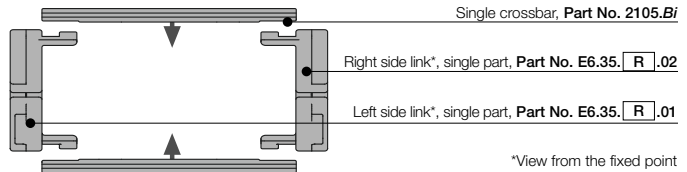

## Part No. E-Chain® - links, single parts

Horizontal and standing  
installations mounted  
at a portal robot reduce  
the noise level

### Option 1: Vertical separators

Vertical separators are used if a vertical subdivision of the E-Chain® interior is required -

By standard vertical separators are assembled every other E-Chain® link!

- **Standard** subdivision with **vertical separator E6.35.11**, for combinations with **full-width shelf 111.X**
- **Middle plate\*** E6.35.12 (slotted 5 times) for combinations with **side plate E6.35.13**, **full-width shelf 221.X** and **Shelf 2210.X**
- **Strain relief separator E6.35.12.Z** (slotted 5 times), can be integrated into the mounting bracket and can be placed there at any point

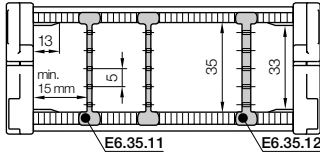

<b>Vert. separator, slotted</b>	
unassembled	E6.35.01
assembled	E6.35.11

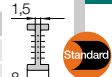

<b>Middle plate</b>	
unassembled	E6.35.02
assembled	E6.35.12



<b>Strain relief separator</b>	
unassembled	E6.35.02.Z
assembled	E6.35.12.Z

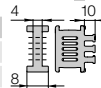

System E6  
Inner height: 35 mm

### Option 2: Full-width shelves

For applications involving many thin cables with similar or identical diameters

- **Full-width shelf 111.X** for combinations with **vertical separator E6.35.11**
- **Full-width shelf 221.X** for combinations with **middle plate E6.35.12**, **strain relief separator E6.35.12.Z**, and **side plate E6.35.13**

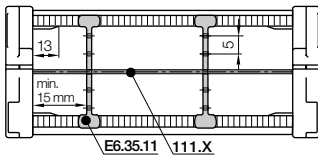

Width X [mm]	Part No. unassembled		Part No. assembled	
	110.X	220.X	111.X	221.X
030	110.30	220.30	111.30	221.30
040	110.40	220.40	111.40	221.40
050	110.50	220.50	111.50	221.50
060	110.60	220.60	111.60	221.60
070	110.70	220.70	111.70	221.70

Width X [mm]	Part No. unassembled		Part No. assembled	
	110.X	220.X	111.X	221.X
080	110.80	220.80	111.80	221.80
090	110.90	220.90	111.90	221.90
100	110.100	220.100	111.100	221.100
110	110.110	220.110	111.110	221.110
120	110.120	220.120	111.120	221.120

#### Full-width shelf

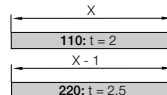

### Option 3: Shelves

Shelves can be arranged elevator-shifted with different bottoms within the entire E-Chain® width

- **Shelf 2210.X** for combinations with **middle plate E6.35.12**, **strain relief separator E6.35.12.Z**, and **side plate E6.35.13**

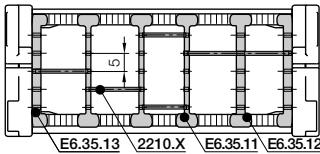

<b>Side plate</b>	
unassembled	E6.35.03
assembled	E6.35.13



Width X [mm]	Part No.	Part No.
	unassembled	assembled
18	2200.18	2210.18
23	2200.23	2210.23
28	2200.28	2210.28
33	2200.33	2210.33
38	2200.38	2210.38
43	2200.43	2210.43

Width X [mm]	Part No.	Part No.
	unassembled	assembled
48	2200.48	2210.48
58	2200.58	2210.58
68	2200.68	2210.68
73	2200.73	2210.73
88	2200.88	2210.88
99	2200.99	2210.99

#### Shelf

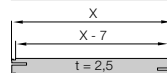

Phone +49- (0) 22 03-96 49-800  
Fax +49- (0) 22 03-96 49-222



▶ page 8.39

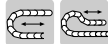

\* KMA = Polymer Metal Mounting Bracket

**Option KMA\* - pivoting**

- Option - integrated C-profile strain relief device with Chainfix clip or strain relief tiwrap plates
- C-profile mountable in the inner or outer radius of the E-Chain®
- Bolted connection outside of chain cross-section
- Recommended for unsupported and gliding applications
- Confined installation conditions
- Universal mountable with attachment capability on all sides

Moving end  
E6.350...2

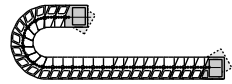

The attachment variants arising automatically by the choice of the KMA mounting bracket

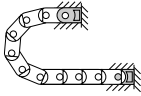

E6.350...1  
Fixed end

**Dimensions and order configurations**

E6.350...2  
Fixed end

E6.350...1  
Moving end

Part No. structure

E6.350.040.12

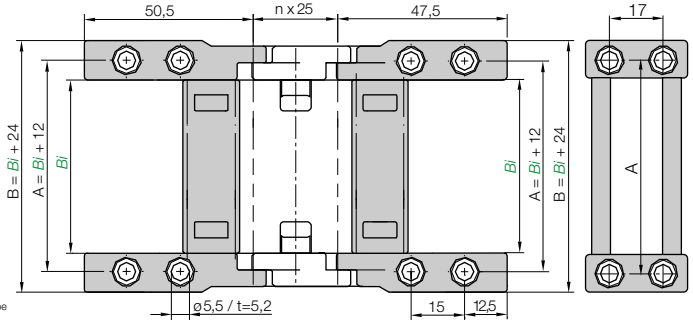

Phone +49- (0) 22 03-96 49-800  
Fax +49- (0) 22 03-96 49-222

Full set, for both ends:

E6.350.040.12

Single-part order:

E6.350.040.1

Fixed end mounting bracket

E6.350.040.2

Moving end mounting bracket

For E-Chain®	Part No. full set	Dim. B [mm]	Dim. A [mm]
E6.35.030.	▶ E6.350.030.12	54	42
E6.35.040.	▶ E6.350.040.12	64	52
E6.40.050.	▶ E6.350.050.12	74	62
E6.40.060.	▶ E6.350.060.12	84	72
E6.40.070.	▶ E6.350.070.12	94	82

For E-Chain®	Part No. full set	Dim. B [mm]	Dim. A [mm]
E6.40.080.	▶ E6.350.080.12	104	92
E6.40.090.	▶ E6.350.090.12	114	102
E6.40.100.	▶ E6.350.100.12	124	112
E6.40.110.	▶ E6.350.110.12	134	122
E6.40.120.	▶ E6.350.120.12	144	132

igus® GmbH  
51147 Cologne

System E6 | E-Chain® | Series E6.35 | Accessories | Strain Relief

**NEW! Strain relief separator**

Separator with integrated strain relief for the use in the first or last chain link. Individual part for the manufacturing of switchgear cabinets or for the assembly of machines. Easy to assemble without any screws ▶ chapter 10.

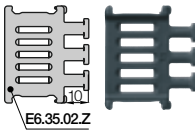

Part No.	Number of teeth	For Series
E6.35.02.Z	3 one side	E6.35 E-Chain®

Internet: [www.igus.de](http://www.igus.de)  
E-mail: [info@igus.de](mailto:info@igus.de)



Other strain relief elements - optional ▶ chapter 10



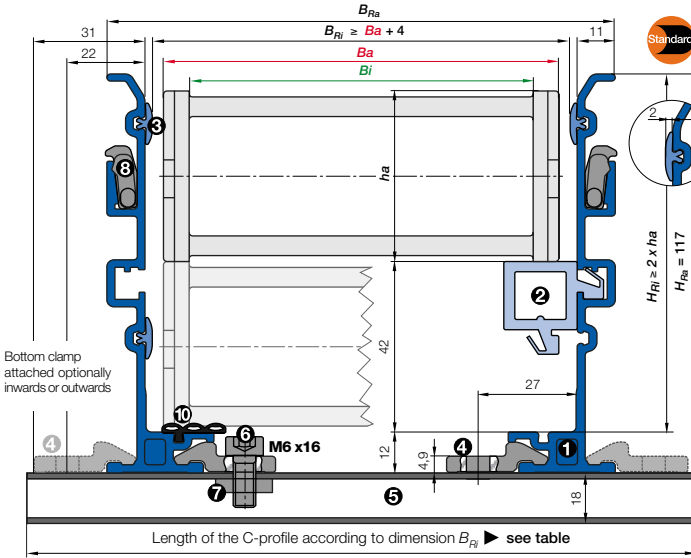

- Ba** = Outer width E-Chains® / E-Tube
  - Bi** = Inner width E-Chains® / E-Tube
  - ha** = Outer height E-Chains® / E-Tube
  - H<sub>Ri</sub>** = Inner trough height
  - H<sub>Ra</sub>** = Outer trough height
  - B<sub>Ri</sub>** = Inner trough width ► depends on dim. Ba
  - B<sub>Ra</sub>** = Outer trough width
  - n<sub>Mon</sub>** = Number of installation sets (left/right)
  - n<sub>Ri</sub>** = Number of trough sets (left/right)
  - H<sub>Ri</sub> ≥ 2 · ha**
  - B<sub>Ri</sub> ≥ Ba + 4**
- = Guide trough set      ● = Glide bar  
 ● = Installation set "Basic"      ● = C-profile

**Installation set "Basic" with C-profile**

Bottom Clamp attached optionally inwards or outwards ►

E6.35.100.063.0 Order example

B <sub>Ri</sub> [mm]	Part No.	
	attached inwards	attached outwards
.040	54	960.30.150
.050	64	960.30.175
.060	74	960.30.125
.062	84	960.30.150
.070	94	960.30.150
.075	104	960.30.150
.087	114	960.30.175
.100	124	960.30.175
.125	134	960.30.200
.150	144	960.30.200

Insert for the installation set "Heavy-Duty": **972.50.XXX** instead of **(960.30.XXX)** on the right column "attached outwards"



- **Components, trough "Basic":** ① Trough side parts, aluminum, 2 m ② Glide bar, plastic, 2 m ③ Glide strips, plastic, 2 m (without glide strips on request) ⑩ Optional: Silencer profile, rubber
- **Components, installation set "Basic":** ④ Bottom clamp, aluminum ⑤ C-profile, steel galvanized ⑥ Screw M6 x 16 ⑦ Sliding nut M6 ⑧ Interface connector, plastic



**Order example: Length of travel 30 m - Center mounted for Series E6.35.100.063.0 with B<sub>Ri</sub> = 124**

- Guide trough set (set of 2 trough side parts, incl. glide strips) **without** glide bar  
**Order text: 16 m guide trough without glide bar (8 x 2 m sections)** Part No. **972.02.30.SL**
- Guide trough set (set of 2 trough side parts, incl. glide strips) **with** glide bar  
**Order text: 16 m guide trough with glide bar (8 x 2 m sections)** Part No. **972.02.31.SL**
- Installation set "Basic" complete (guide trough-sets + 1)  
**Order text: 17 installation sets "Basic"** Part No. **960.30.175**
- Module for the fixed end  
**Order text: 1 set** Part No. **972.82**
- Option:** For an additional noise dampening with silencer profile, please add Index A - Example: Part No. **972.02.30.SLA**



Principle sketch: Number of installation sets to be installed = **Number of trough sections + 1**

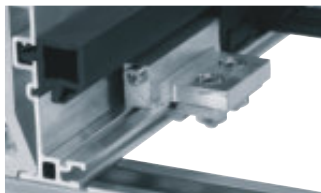

**NEW! A quick fix for mounting the stationary end of an E-Chain®**

With this new module for the fixed end, fast and easy mounting onto the Aluminum "SuperTrough" is now possible without any drilling. Fast mounting of the E-Chain® by clamping onto the aluminum trough

- Quick relocation of the stationary end
- No drilling necessary ► **page 9.16**

Phone +49- (0) 22 03-96 49-800  
 Fax +49- (0) 22 03-96 49-222



► **Chapter 10**  
 ► **Chapter 9**  
 ► **page 8.39**



Price index



Extremely low noise  
Test results upon request



Cleanroom test  
upon request



ATEX-ESD Standard Material: igamid G  
- ESD compatibility Level 1 according  
to SEMI E78-0998 ESD igamid ESD  
special material (upon request); Superior  
long-term conductivity due to lack of  
pin and bore tolerances (no air gaps)



To close, push and click shut



#### When to use the Series E6.40:

- If a low-noise version is required
- At very high speeds and/or accelerations
- For enlarged thrusts and tensile forces
- For small bending radii
- If less vibration is required
- Minimal abrasion  
(e.g. cleanroom applications)



#### When not to use it:

- Limited in side-mounted applications  
▶ Series 280/290 System E4, page 7.26
- No use with RBR (reverse bending radius)  
▶ Series 280/290 System E4, page 7.26
- No use with high additional loads  
▶ Series 280/290 System E4, page 7.26
- No use in dirty environments  
▶ Series 280/290 System E4, page 7.26

- ① No pin and bore connection
- ② Small pitch for low-noise, smooth operation
- ③ Very large gliding surfaces
- ④ Interior stop dog
- ⑤ KMA mounting brackets with attachment points on all sides (strain relief with separate tie-wrap plates possible)
- ⑥ Can be shortened or lengthened due to modular design
- ⑦ Optional with or without integrated C-profile
- ⑧ Series R6.40 - E-Tube-version available on request

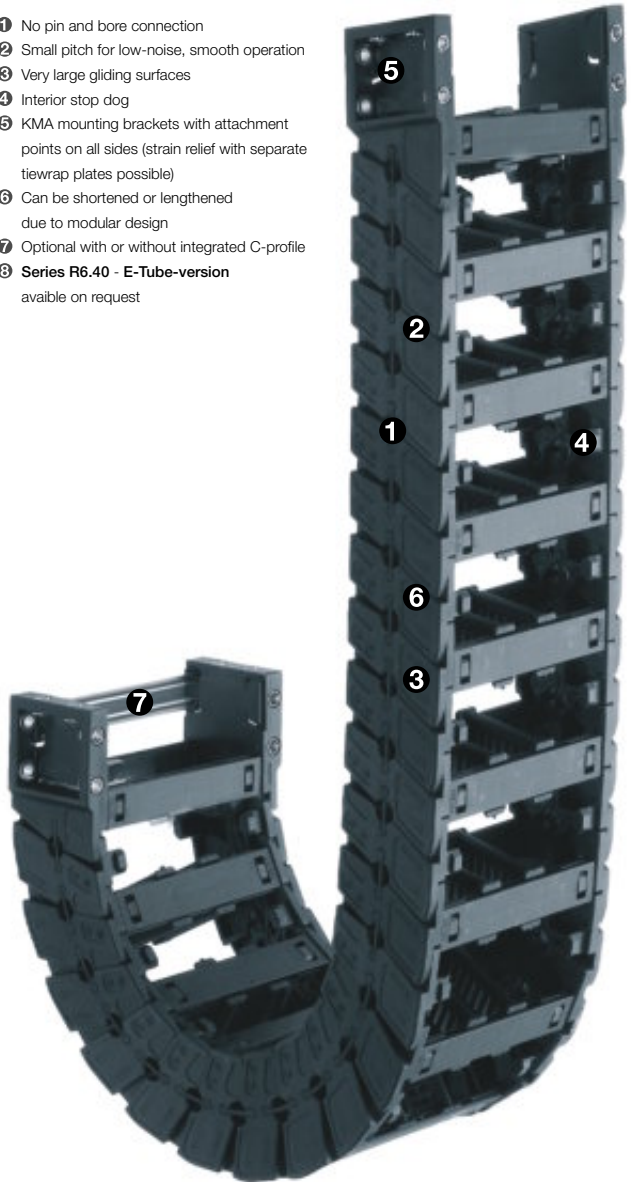

#### Order example complete E-Chain®

Please indicate chain-lengths or number of links Example: 2 m or 72 links

2 m **E6.40.100.075.0**



E-Chain®

with 2 separators **28222** assembled every 2<sup>nd</sup> link



Interior separation

1 set **E6.400.100.12**



Mounting bracket

**Unsupported length**

$FL_G$  = with straight upper run

$FL_B$  = with permitted sag

Further information ► **Design, page 1.12**

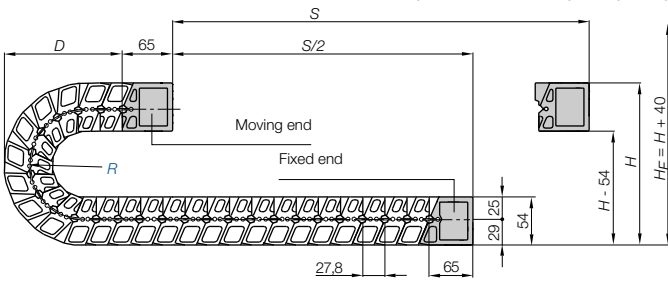
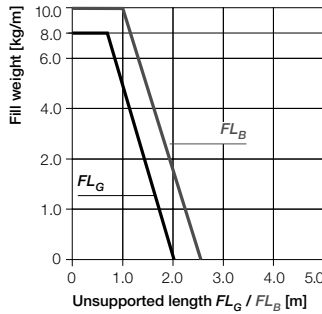
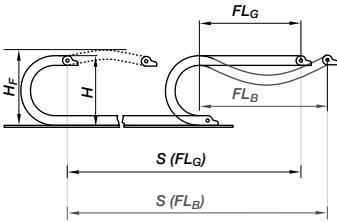

**Pitch = 27,8 mm/link Links/m = 36 (1001 mm) Chain length =  $S/2 + K$**

R	063	075	100	125	150	200
H (min.)	184	208	258	308	358	458
D	120	132	157	182	207	257
K	255	295	370	450	530	685
$D_2^{+25}$	214	263	388	574	760	1382
$K_2$	112	306	743	723	973	1474

- S = Length of travel
- R = Bending radius
- H = Nominal clearance height
- $H_F$  = Required clearance height
- $H_{in}$  = Trough inner height
- D = Overlength E-Chain® radius in final position
- K =  $\pi \cdot R$  + "safety"
- $D_2$  = Over length for long travels gliding
- $K_2$  = Further add-on if the mounting bracket location is set lower

**Other installation methods**

- Vertical, hanging  $\leq 30$  m
- Vertical, standing  $\leq 2$  m
- Side mounted, unsupported = possible to a limited extent
- Unsupported length of upper run = upon request



**Short travels - unsupported**

Unsupported E-Chains® feature positive camber over short travels. This must be accounted for when specifying the clearance height  $H_F$ . Please consult igus® if space is particularly restricted.

The required clearance height:  
 **$H_F = H + 40$  mm**  
 (with 2,0 kg/m fill weight)

**Long travel lengths from 6 m to max. 60 m Chain length =  $S/2 + K_2$**

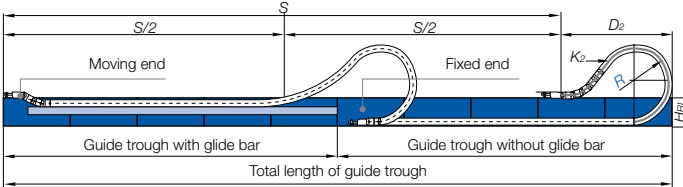

In case of travels between 4 m and 6 m we recommend a longer unsupported length.



**Gliding, long travel applications (max. 60 m)**

In this case the E-Chain® upper run will be introduced in a guide trough on the lower run. We recommend to realize the engineering of such a plant by our technicians.

Speed / acceleration $FL_G$	max. 20 [m/s] / max. 200 [m/s <sup>2</sup> ]
Speed / acceleration $FL_B$	max. 3 [m/s] / max. 6 [m/s <sup>2</sup> ]
Gliding speed / acceleration (maximum)	upon request
permitted temperature °C	-40° up to +100° C
Flammability class	VDE 0304 IIC UL94 HB

**Technical Data**



Details of material properties  
 ► **page 1.38**

System E6  
 Inner height: 40 mm

Phone +49- (0) 22 03-96 49-800  
 Fax +49- (0) 22 03-96 49-222



► **page 8.39**

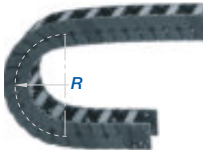
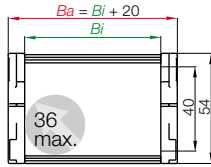

Part No. structure

E6.40.100.100.0

Series E6.40 - with crossbars every 2<sup>nd</sup> link

Part No.	Bi [mm]	Ba [mm]	R [mm]	Bending radii				Weight [kg/m]
E6.40.040.□.0	40	60	063 075	100	125	150	200	≈ 1,29
E6.40.050.□.0	50	70	063 075	100	125	150	200	≈ 1,33
E6.40.062.□.0	62	82	063 075	100	125	150	200	≈ 1,38
E6.40.070.□.0	70	90	063 075	100	125	150	200	≈ 1,41
E6.40.075.□.0	75	95	063 075	100	125	150	200	≈ 1,43
E6.40.087.□.0	87	107	063 075	100	125	150	200	≈ 1,48
E6.40.100.□.0	100	120	063 075	100	125	150	200	≈ 1,53
E6.40.125.□.0	125	145	063 075	100	125	150	200	≈ 1,63
E6.40.150.□.0	150	170	063 075	100	125	150	200	≈ 1,73
E6.40.175.□.0	175	195	063 075	100	125	150	200	≈ 1,83
E6.40.200.□.0	200	220	063 075	100	125	150	200	≈ 1,93
E6.40.225.□.0	225	245	063 075	100	125	150	200	≈ 2,02
E6.40.250.□.0	250	270	063 075	100	125	150	200	≈ 2,12
E6.40.275.□.0	275	295	063 075	100	125	150	200	≈ 2,22
E6.40.300.□.0	300	320	063 075	100	125	150	200	≈ 2,32

Supplement Part No. with required radius. Example: E6.40.100.□.100.0

0 = standard color, other colors ► page 1.39 · Pitch = 27,8 mm/link - Links/m = 36

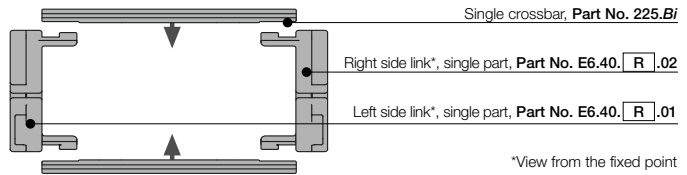
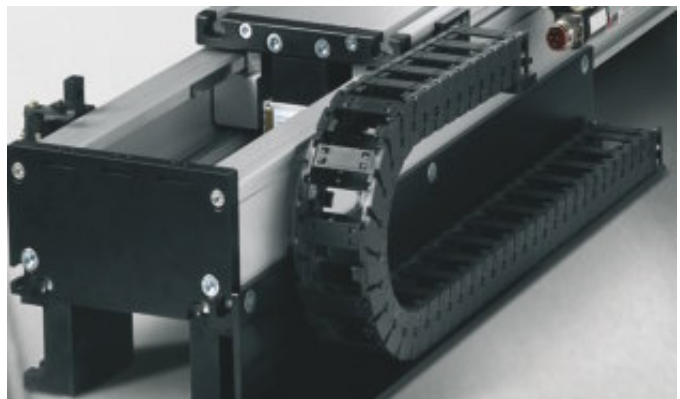

## Part No. E-Chain® - links, single parts

igus® System E6 on a  
linear drive for high speeds

### Option 1: Vertical separators

Vertical separators are used if a vertical subdivision of the E-Chain® interior is required -

By standard vertical separators are assembled every other E-Chain® link

- Standard subdivision with vertical separator, slotted 28222 -

for combinations with full-width shelf 221.X

- Locking vertical separator E6.40.12, (slotted, 7 times) - for combinations with shelf 2210.X

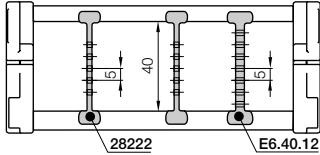

Vert. separator, slotted

unassembled 28221

assembled 28222



Locking vertical separator

unassembled E6.40.02

assembled E6.40.12



### Option 2: Full-width shelves

For applications involving many thin cables with similar or identical diameters

- Full-width shelf 221.X for combinations with

Vertical separator, slotted 28222 and Side plate E6.40.13 und Asymmetrical separator E6.40.18

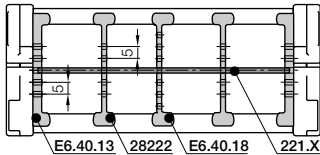

Side plate

unassembled E6.40.03

assembled E6.40.13



Asymmetrical separator

unassembled E6.40.08

assembled E6.40.18



Width X [mm]	Part No. unassembled	Part No. assembled
40	220.40	221.40
50	220.50	221.50
62	220.62	221.62
70	220.70	221.70
75	220.75	221.75
87	220.87	221.87

Width X [mm]	Part No. unassembled	Part No. assembled
100	220.100	221.100
125	220.125	221.125
150	220.150	221.150
175	220.175	221.175
200	220.200	221.200

Full-width shelf

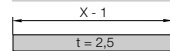

### Option 3: Shelves

Shelves can be arranged elevator-shifted with different bottoms within the entire E-Chain® width

- Shelf 2210.X for combinations with Locking vertical separator E6.40.12, and side plate E6.40.13

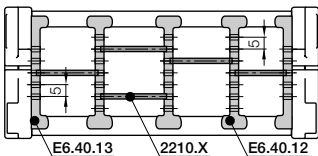

Width X [mm]	Part No. unassembled	Part No. assembled
18	2200.18	2210.18
23	2200.23	2210.23
28	2200.28	2210.28
33	2200.33	2210.33
38	2200.38	2210.38
43	2200.43	2210.43

Width X [mm]	Part No. unassembled	Part No. assembled
48	2200.48	2210.48
58	2200.58	2210.58
68	2200.68	2210.68
73	2200.73	2210.73
88	2200.88	2210.88
99	2200.99	2210.99

Shelf

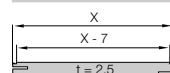

System E6  
Inner height: 40 mm

Phone +49- (0) 22 03-96 49-800  
Fax +49- (0) 22 03-96 49-222



▶ page 8.39

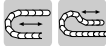

\* KMA = Polymer Metal Mounting Bracket

### Option KMA\* - pivoting

- Option - integrated C-profile strain relief device with Chainfix clip or strain relief tiwrap plates
- C-profile mountable in the inner or outer radius of the E-Chain®
- Bolted connection outside of chain cross-section
- Recommended for unsupported and gliding applications
- Confined installation conditions
- Universal mountable with attachment capability on all sides

Moving end  
E6.400...2

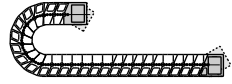

The attachment variants arising automatically by the choice of the KMA mounting bracket

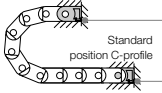

E6.400...1  
Fixed end

### Dimensions and order configurations



Adapters for gliding applications available upon request

#### Part No. structure

E6.400.040.12.C

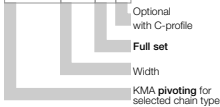

Full set, for both ends:

[E6.400.040.12](#)

Single-part order:

[E6.400.040.1](#)

Fixed end mounting bracket

[E6.400.040.2](#)

Moving end mounting bracket

E6.400...2

Fixed end

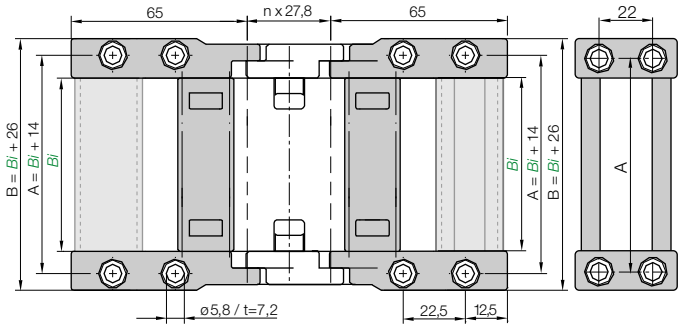

E6.400...1

Moving end

For E-Chain®	Part No. full set optional with C-profile	Dim. A [mm]	Dim. B [mm]
E6.40.040.	▶ E6.400.040.12.C	54	66
E6.40.050.	▶ E6.400.050.12.C	64	76
E6.40.062.	▶ E6.400.062.12.C	76	88
E6.40.070.	▶ E6.400.070.12.C	84	96
E6.40.075.	▶ E6.400.075.12.C	89	101
E6.40.087.	▶ E6.400.087.12.C	101	113
E6.40.100.	▶ E6.400.100.12.C	114	126
E6.40.125.	▶ E6.400.125.12.C	139	151

For E-Chain®	Part No. full set optional with C-profile	Dim. A [mm]	Dim. B [mm]
E6.40.150.	▶ E6.400.150.12.C	164	176
E6.40.175.	▶ E6.400.175.12.C	189	201
E6.40.200.	▶ E6.400.200.12.C	214	226
E6.40.225.	▶ E6.400.225.12.C	239	251
E6.40.250.	▶ E6.400.250.12.C	264	276
E6.40.275.	▶ E6.400.275.12.C	289	301
E6.40.300.	▶ E6.400.300.12.C	314	326

Phone +49- (0) 22 03-96 49-800  
Fax +49- (0) 22 03-96 49-222

igus® GmbH  
51147 Cologne

Internet: [www.igus.de](http://www.igus.de)  
E-mail: [info@igus.de](mailto:info@igus.de)

### System E6 | E-Chain® | Series E6.40 | Accessories | Strain Relief

Strain relief tiwrap plate can be fixed on the last crossbar, alternatively with C-profile. Tiwrap plate as individual part - Part No. 20XX.ZB. Further strain relief elements ▶ chapter 10



Other strain relief elements - optional ▶ chapter 10



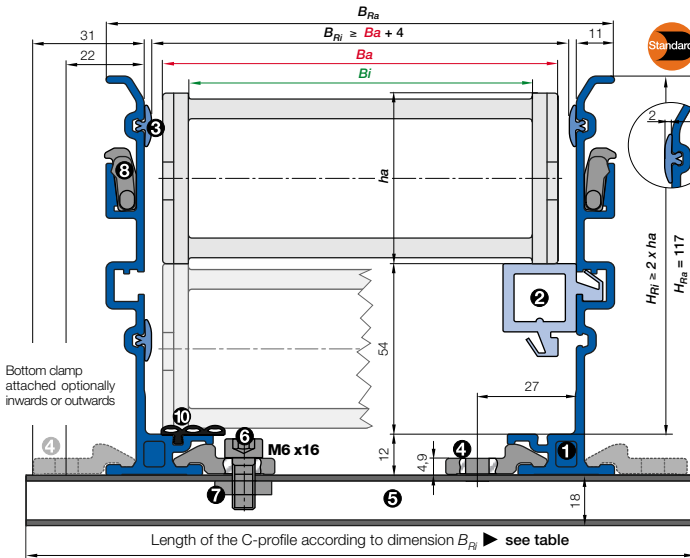

- $B_a$  = Outer width E-Chains\* / E-Tube
  - $B_i$  = Inner width E-Chains\* / E-Tube
  - $h_a$  = Outer height E-Chains\* / E-Tube
  - $H_{Ri}$  = Inner trough height
  - $H_{Ra}$  = Outer trough height
  - $B_{Ri}$  = Inner trough width ► depends on dim.  $B_a$
  - $B_{Ra}$  = Outer trough width
  - $n_{Mon}$  = Number of installation sets (left/right)
  - $n_{Ri}$  = Number of trough sets (left/right)
- $H_{Ri} \geq 2 \cdot h_a$   
 $B_{Ri} \geq B_a + 4$
- = Guide trough set
  - = Installation set "Basic"
  - = Glide bar
  - = C-profile

**Installation set "Basic" with C-profile**

Bottom Clamp attached optionally inwards or outwards ►

E6.40.040.063.0 Order example

$B_{Ri}$ [mm]	Part No.	
	attached inwards	attached outwards
.040	64	960.30.175
.050	74	960.30.125 960.30.175
.062	86	960.30.150 960.30.200
.070	94	960.30.150 960.30.200
.075	99	960.30.150 960.30.200
.087	111	960.30.175 960.30.225
.100	124	960.30.175 960.30.225
.125	149	960.30.200 960.30.250
.150	174	960.30.225 960.30.275
.175	199	960.30.250 960.30.300
.200	224	960.30.275 960.30.325
.225	249	960.30.300 960.30.350
.250	274	960.30.325 960.30.375
.275	299	960.30.350 960.30.400
.300	324	960.30.375 960.30.425



- **Components, trough "Basic":** ① Trough side parts, aluminum, 2 m ② Glide bar, plastic, 2 m ③ Glide strips, plastic, 2 m (without glide strips on request) ⑩ Optional: Silencer profile, rubber
- **Components, installation set "Basic":** ④ Bottom clamp, aluminum ⑤ C-profile, steel galvanized ⑥ Screw M6 x16 ⑦ Sliding nut M6 ⑧ Interface connector, plastic

**Order example: Length of travel 30 m - Center mounted for Series E6.40.050.063.0 with  $B_{Ri} = 74$**

Guide trough set (set of 2 trough side parts, incl. glide strips) <b>without</b> glide bar	Part No.	972.30.SL
Order text: 16 m guide trough without glide bar (8 x 2 m sections)		
Guide trough set (set of 2 trough side parts, incl. glide strips) <b>with</b> glide bar	Part No.	972.31.SL
Order text: 16 m guide trough with glide bar (8 x 2 m sections)		
Installation set "Basic" complete (guide trough-sets + 1)	Part No.	960.30.150
Order text: 17 installation sets "Basic"		
Module for the fixed end	Part No.	972.80
Order text: 1 set		
Option: For an additional noise dampening with silencer profile, please add Index A - Example:	Part No.	972.30.SLA

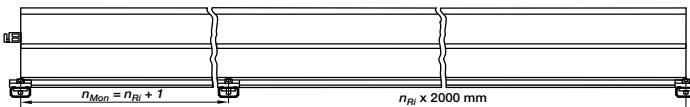

Principle sketch: Number of installation sets to be installed = **Number of trough sections + 1**

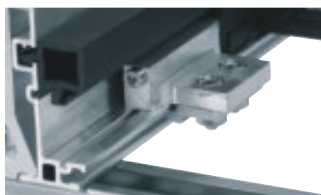

**NEW! A quick fix for mounting the stationary end of an E-Chain\***

With this new module for the fixed end, fast and easy mounting onto the Aluminum "SuperTrough" is now possible without any drilling. Fast mounting of the E-Chain\* by clamping onto the aluminum trough

- Quick relocation of the stationary end
- No drilling necessary ► page 9.16

Insert for the installation set "Heavy-Duty": **972.50.XXX** instead of **(960.30.XXX)** on the right column "attached outwards"

Tel. +49- (0) 22 03-96 49-800  
 Fax +49- (0) 22 03-96 49-222



► Chapter 10



► Chapter 9



► page 8.39



● ● ● Price index



**Extremely low noise**  
Test results upon request



**Cleanroom test**  
upon request



**ATEX-ESD Standard Material: igamid G**  
- ESD compatibility Level 1 according to SEMI E78-0998 ESD igamid ESD special material (upon request): Superior long-term conductivity due to lack of pin and bore tolerances (no air gaps)



Deckel entfernen durch aufhebeln



**When to use the Series R6.40:**

- If a low-noise version is required
- At very high speeds and/or accelerations
- For enlarged thrusts and tensile forces
- For small bending radii
- If less vibration is required
- Minimal abrasion  
(e.g. cleanroom applications)



**When not to use it:**

- Limited in side-mounted applications  
▶ Series R770 System E4/00, page 7.26

- 1 Fully enclosed E-Tube
- 2 No pin and bore connection, minimal abrasion
- 3 Can be shortened or lengthened due to modular design
- 4 Very large gliding surfaces
- 5 Interior stop dog
- 6 Small pitch for low-noise, smooth operation
- 7 KMA mounting brackets with attachment points on all sides (strain relief with separate tiewrap plates possible)



**Order example complete E-Chain®**

Please indicate chain-lengths or number of links **Example: 2 m or 72 links**

2 m **R6.40.062.075.0**



**E-Chain®**

with 2 separators **R6.40.11** assembled every 2<sup>nd</sup> link



**Interior separation**

1 set **R6.400.062.12**



**Mounting bracket**

**Unsupported length**

$FL_G$  = with straight upper run

$FL_B$  = with permitted sag

Further information ► **Design, page 1.12**

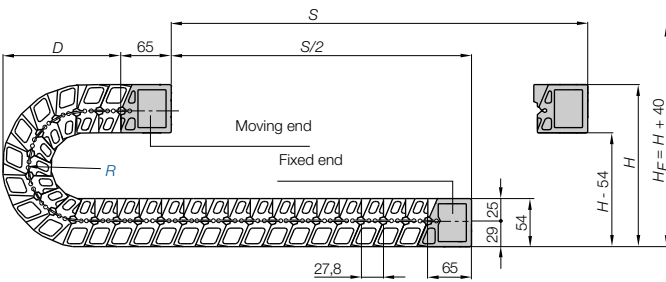
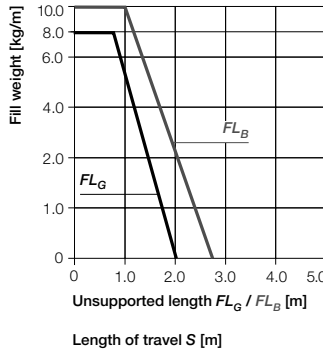
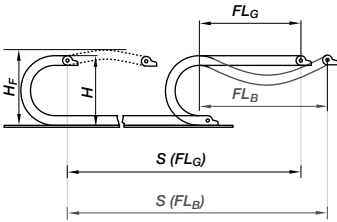

Pitch = 27,8 mm/link Links/m = 36 (1.000,8 mm) Chain length =  $S/2 + K$

R	063	075	100	125	150	200
H	184	208	258	308	358	458
D	120	132	157	182	207	257
K	255	295	370	450	530	685

- S = Length of travel
- R = Bending radius
- H = Nominal clearance height
- H<sub>F</sub> = Required clearance height
- D = Overlength E-Chain® radius in final position
- K =  $\pi \cdot R + \text{"safety"}$

**Other installation methods**

- Vertical, hanging  $\leq 30$  m
- Vertical, standing  $\leq 2$  m
- Side mounted, unsupported = possible to a limited extent
- Unsupported length of upper run = upon request



**Short travels - unsupported**

Unsupported E-Chains® feature positive camber over short travels. This must be accounted for when specifying the clearance height H<sub>F</sub>. Please consult igus® if space is particularly restricted.

The required clearance height:  
**H<sub>F</sub> = H + 40 mm**  
 (with 2,0 kg/m fill weight)

40

System E6  
Inner height: 40 mm

Phone +49- (0) 22 03-96 49-800  
Fax +49- (0) 22 03-96 49-222



Trough E6.40  
► page 8.61



► page 8.39

**TPE-data cable for max. requirements - Chainflex® CF11**

Shielded, oil-resistant and bio-oil-resistant, PVC- and halogen-free  
 Further information: [www.igus.de/en/CF11](http://www.igus.de/en/CF11)

IGUS® CHAINFLEX® CF11



TIPP!

Speed / acceleration $FL_G$	max. 20 [m/s] / max. 200 [m/s <sup>2</sup> ]
Speed / acceleration $FL_B$	max. 3 [m/s] / max. 6 [m/s <sup>2</sup> ]
Gliding speed / acceleration (maximum)	upon request
Material - permitted temperature °C	-40° up to +100° C
Flammability class	VDE 0304 IIC UL94 HB

**Technical Data**



Details of material properties  
 ► page 1.38

igus® E-ChainSystems®

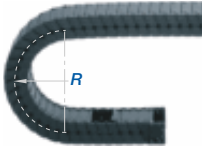
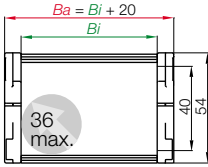

Part No. structure

R6.40.062.100.0



**Series E6.40 - E-Tube, lids can be removed along inner and outer radius**

Part No.	Bi [mm]	Ba [mm]	R [mm]	Bending radii	Weight [kg/m]
R6.40.062.	62	82	063	075 100 125 150 200	~ 1,38

The widths 075 / 087 / 100 / 125 / 150 / 175 / 200 / 225 / 275 / 300 are available upon request.

Time of delivery approx. 6-8 weeks after order.

Supplement Part No. with required radius. Example: R6.40.100.100.0

0 = standard color, other colors ▶ page 1.39 · Pitch = 27,8 mm/link - Links/m = 36



Phone +49- (0) 22 03-96 49-800  
Fax +49- (0) 22 03-96 49-222

**Vertical separator**

unassembled	R6.40.01
assembled	R6.40.11



System E6 | E-Tube | **Series R6.40** | Accessories | Interior Separation

**Option 1: Vertical separators**

Vertical separators are used if a vertical subdivision of the E-Chain® interior is required - By standard vertical separators are assembled every other E-Chain® link!

- The notches on this separator marks the sticking side for a stuck mounting on the lid
- Standard subdivision with vertical separator R6.40.11



Vertical separator  
E6.40.01  
(side view)

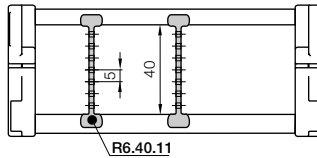

igus® GmbH  
51147 Cologne

Internet: [www.igus.de](http://www.igus.de)  
E-mail: [info@igus.de](mailto:info@igus.de)

Low-noise low vibrations  
with E6. Designed to  
withstand high  
dynamic loads



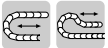

\* KMA = Polymer Metal Mounting Bracket

**Option KMA\* - pivoting**

- Option - integrated C-profile strain relief device with Chainfix clip or strain relief tiewrap plates
- C-profile mountable in the inner or outer radius of the E-Chain®
- Bolted connection outside of chain cross-section
- Recommended for unsupported and gliding applications
- Confined installation conditions
- Universal mountable with attachment capability on all sides

Moving end  
R6.400...2

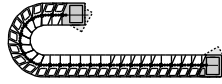

R6.400...1  
Fixed end



The attachment variants arising automatically by the choice of the KMA mounting bracket

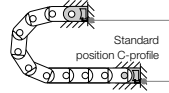

R6.400...2  
Fixed end

R6.400...1  
Moving end

**Dimensions and order configurations**

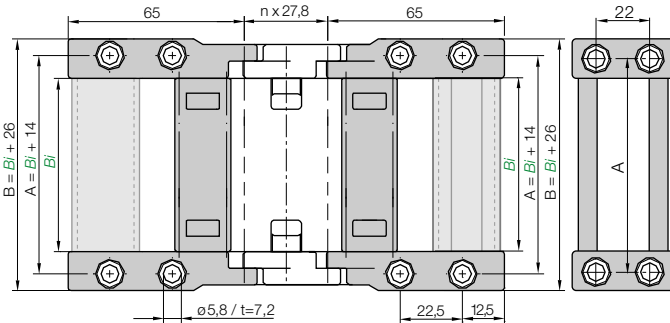

Part No. structure

R6.400.062.12.C

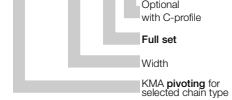

Full set, for both ends:

R6.400.062.12

Single-part order:

R6.400.062.1

Fixed end mounting bracket

R6.400.062.2

Moving end mounting bracket

For E-Chain®	Part No. full set optional with C-profile	Dim. A [mm]	Dim. B [mm]
R6.40.062. ▶	R6.400.062.12. C	76	88

System E6 | E-Tube | **Series R6.40 | Accessories** | Strain Relief

Strain relief tiewrap plate can be fixed on the last crossbar, alternatively with C-profile. Tiewrap plate as individual part - **Part No. 30XX.ZB**. Further strain relief elements ▶ **chapter 10**



Other strain relief elements - optional ▶ **chapter 10**



Trough E6.40  
▶ page 8.61



▶ page 8.39



Price index



**Extremely low noise**  
Test results upon request



**Cleanroom test**  
upon request



**ATEX-ESD Standard Material: igumid G**  
- ESD compatibility Level 1 according to SEMI E78-0998 ESD igumid ESD special material (upon request); Superior long-term conductivity due to lack of pin and bore tolerances (no air gaps)



To close, push and click shut



**When to use the Series E6.52:**

- If a low-noise version is required
- At very high speeds and/or accelerations
- For enlarged thrusts and tensile forces
- For small bending radii
- If less vibration is required
- Minimal abrasion  
(e.g. cleanroom applications)



**When not to use it:**

- Limited in side-mounted applications
  - ▶ **Series 3838 System E4, page 7.104**
- No use with RBR (reverse bending radius)
  - ▶ **Series 3838 System E4, page 7.104**
- No use with high additional loads
  - ▶ **Series 3838 System E4, page 7.104**
- No use in dirty environments
  - ▶ **Series 3838 System E4, page 7.104**

- ① No pin and bore connection
- ② Interior stop dog
- ③ Very large gliding surfaces
- ④ Small pitch for low-noise, smooth operation
- ⑤ Can be shortened or lengthened due to modular design
- ⑥ KMA mounting brackets with attachment points on all sides (strain relief with separate tie-wrap plates possible)
- ⑦ Optional with or without integrated C-profile

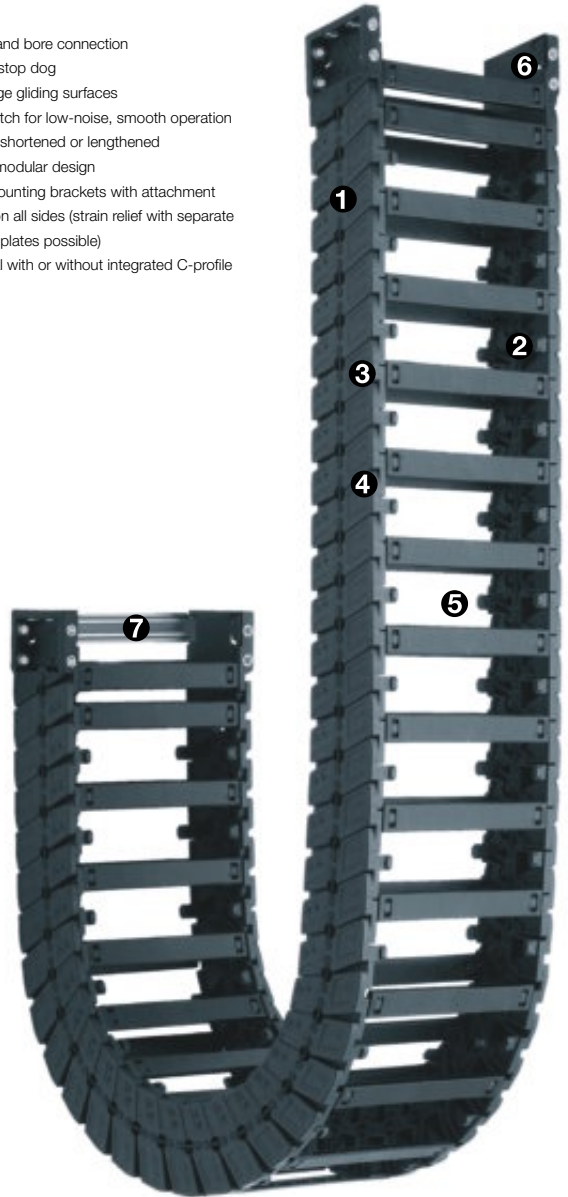

**Order example complete E-Chain®**

Please indicate chain-lengths or number of links **Example: 2 m or 68 links**

2 m **E6.52.100.075.0**



**E-Chain®**

with 2 separators **38222** assembled every 2<sup>nd</sup> link



**Interior separation**

1 set **E6.520.100.12**



**Mounting bracket**

**Unsupported length**

$FL_G$  = with straight upper run

$FL_B$  = with permitted sag

Further information ► **Design, page 1.12**

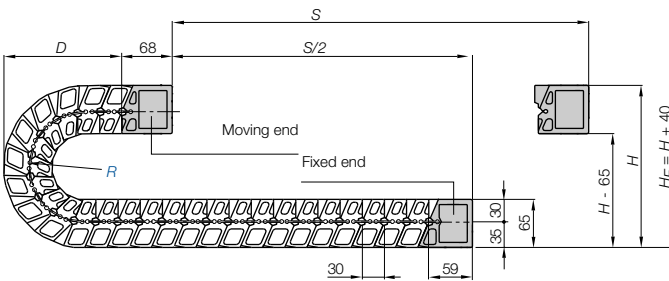
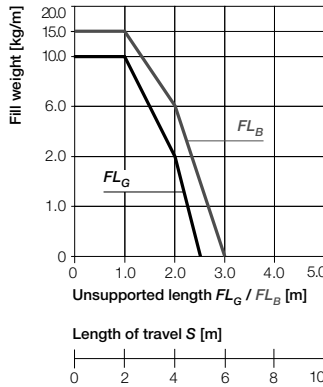
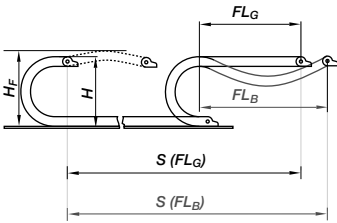

**Pitch = 30 mm/link Links/m = 34 (1020 mm) Chain length =  $S/2 + K$**

R	075	100	150	200	250
H	220	270	370	470	570
D	140	165	215	265	315
K	300	375	535	690	850
$D_2^{+25}$	270	398	768	1138	1508
$K_2$	300	480	990	1470	1950

- S = Length of travel
- R = Bending radius
- H = Nominal clearance height
- $H_F$  = Required clearance height
- $H_{in}$  = Trough inner height
- D = Overlength E-Chain® radius in final position
- $K = \pi \cdot R + \text{"safety"}$
- $D_2$  = Over length for long travels gliding
- $K_2$  = Further add-on if the mounting bracket location is set lower

**Other installation methods**

- Vertical, hanging  $\leq 50$  m
- Vertical, standing  $\leq 2$  m
- Side mounted, unsupported = possible to a limited extent
- Unsupported length of upper run = upon request



**Short travels - unsupported**

Unsupported E-Chains® feature positive camber over short travels. This must be accounted for when specifying the clearance height  $H_F$ . Please consult igus® if space is particularly restricted.

The required clearance height:  
 $H_F = H + 40$  mm  
 (with 2,0 kg/m fill weight)

**Long travel lengths from 6 m to max. 80 m Chain length =  $S/2 + K_2$**

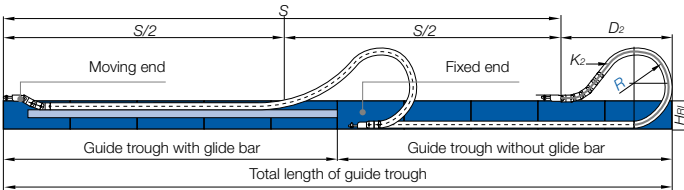

In case of travels between 4 and 6 m we recommend a longer unsupported length.



**Gliding, long travel applications (max. 80 m)**

In this case the E-Chain® upper run will be introduced in a guide trough on the lower run. We recommend to realize the engineering of such a plant by our technicians.

Speed / acceleration $FL_G$	max. 20 [m/s] / max. 200 [m/s <sup>2</sup> ]
Speed / acceleration $FL_B$	max. 3 [m/s] / max. 6 [m/s <sup>2</sup> ]
Gliding speed / acceleration (maximum)	upon request
permitted temperature °C	-40° up to +100° C
Flammability class	VDE 0304 IIC UL94 HB

**Technical Data**



Details of material properties  
 ► page 1.38

52

System E6  
 Inner height: 52 mm

Phone +49- (0) 22 03-96 49-800  
 Fax +49- (0) 22 03-96 49-222



► page 8.39



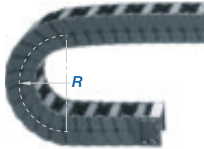
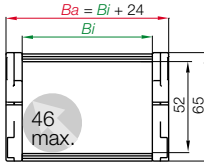

Part No. structure

E6.52.100.075.0

Color  
black  
Bending  
radius  
Width  
SeriesSeries E6.52 - with crossbars every 2<sup>nd</sup> link

Part No.	$B_l$ [mm]	$B_a$ [mm]	$R$ [mm]	Bending radii				Weight [kg/m]
E6.52.040.□.0	40	64	075	100	150	200	250	~ 1,76
E6.52.050.□.0	50	74	075	100	150	200	250	~ 1,80
E6.52.062.□.0	62	86	075	100	150	200	250	~ 1,84
E6.52.070.□.0	70	94	075	100	150	200	250	~ 1,87
E6.52.075.□.0	75	99	075	100	150	200	250	~ 1,89
E6.52.087.□.0	87	111	075	100	150	200	250	~ 1,94
E6.52.100.□.0	100	124	075	100	150	200	250	~ 1,98
E6.52.125.□.0	125	149	075	100	150	200	250	~ 2,07
E6.52.150.□.0	150	174	075	100	150	200	250	~ 2,17
E6.52.175.□.0	175	199	075	100	150	200	250	~ 2,26
E6.52.200.□.0	200	224	075	100	150	200	250	~ 2,36
E6.52.225.□.0	225	249	075	100	150	200	250	~ 2,45
E6.52.250.□.0	250	274	075	100	150	200	250	~ 2,54
E6.52.275.□.0	275	299	075	100	150	200	250	~ 2,64
E6.52.300.□.0	300	324	075	100	150	200	250	~ 2,73

Supplement Part No. with required radius. Example: E6.52.100.075.0

0 = standard color, other colors ► page 1.39 · Pitch = 30 mm/link - Links/m = 34

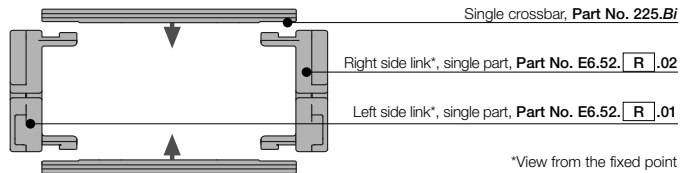

## Part No. E-Chain® - links, single parts

Pick and place robot - speed  
8m/s, acceleration 78,5 m/s<sup>2</sup>



### Option 1: Vertical separators and spacers

Vertical separators are used if a vertical subdivision of the E-Chain® interior is required -

By standard vertical separators are assembled every other E-Chain® link

- **Standard** subdivision with **middle plate, slotted 38222** and **Spacers 215.09**
  - If a broad distance shall be kept between the separators, **Spacers 215.09** can be used.
- They are generally used on side-mounted E-Chains®

- **Separator 382213** purely for easy separation of the E-Chain®

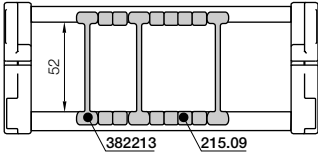

Separator	
unassembled	382212
assembled	382213

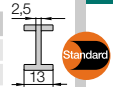

Spacer*	
unassembled	205.09
assembled	215.09



\* for side-mounted applications

System E6  
Inner height: 52 mm

### Option 2: Full-width shelves

For applications involving many thin cables with similar or identical diameters

- **Slotted separators 38226** - for applications with **full-width shelf 221.X**
- **Locking vertical separator 382215** - for applications with **full-width shelf 221.X**

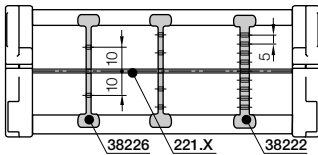

Slotted separator	
unassembled	38225
assembled	38226



Locking separator	
unassembled	38228
assembled	38229



Middle plate, slotted	
unassembled	38221
assembled	38222



Width X [mm]	Part No. unassembled		Part No. assembled	
	220.X	320.X	221.X	321.X
050	220.050	320.050	221.050	321.050
075	220.075	320.075	221.075	321.075
100	220.100	320.100	221.100	321.100
115	220.115	320.115	221.115	321.115
125	220.125	320.125	221.125	321.125

Width X [mm]	Part No. unassembled		Part No. assembled	
	220.X	320.X	221.X	321.X
150	220.150	320.150	221.150	321.150
175	220.175	320.175	221.175	321.175
200	220.200	320.200	221.200	321.200
225	220.225	320.225	221.225	321.225
250	220.250	320.250	221.250	321.250

Full-width shelf	
X - 1	
220: t = 2,5	
X - 1	
320: t = 3,4	

### Option 3: Shelves

Shelves can be arranged elevator-shifted with different bottoms within the entire E-Chain® width

- Shelf **2210.X** for combinations with **middle plate 38222** (slotted, 9 times), **locking separator 382215** (slotted, 9 times) with higher retention force and **side plate 38224**

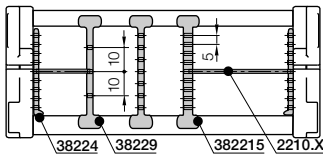

Locking separator	
unassembled	382214
assembled	382215



Side plate	
unassembled	38223
assembled	38224



Width X [mm]	Part No.	Part No.
	unassembled	assembled
18	2200.18	2210.18
23	2200.23	2210.23
28	2200.28	2210.28
33	2200.33	2210.33
38	2200.38	2210.38
43	2200.43	2210.43
48	2200.48	2210.48

Width X [mm]	Part No.	Part No.
	unassembled	assembled
58	2200.58	2210.58
68	2200.68	2210.68
73	2200.73	2210.73
88	2200.88	2210.88
99	2200.99	2210.99
124	2200.124	2210.124
149	2200.149	2210.149

Shelf	
X	
X - 7	
t = 2,5	



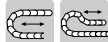

\* KMA = Polymer Metal Mounting Bracket

Moving end  
E6.520...2

**Option KMA\* - pivoting**

- Option - integrated C-profile strain relief device with Chainfix clip or strain relief tiwrap plates
- C-profile mountable in the inner or outer radius of the E-Chain®
- Bolted connection outside of chain cross-section
- Recommended for unsupported and gliding applications
- Confined installation conditions
- Universal mountable with attachment capability on all sides

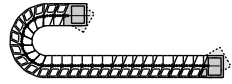

The attachment variants arising automatically by the choice of the KMA mounting bracket

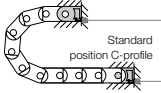

E6.520...1  
Fixed end

**Dimensions and order configurations**

E6.520...2  
Moving end

E6.520...1  
Fixed end



Adapters for gliding applications available upon request

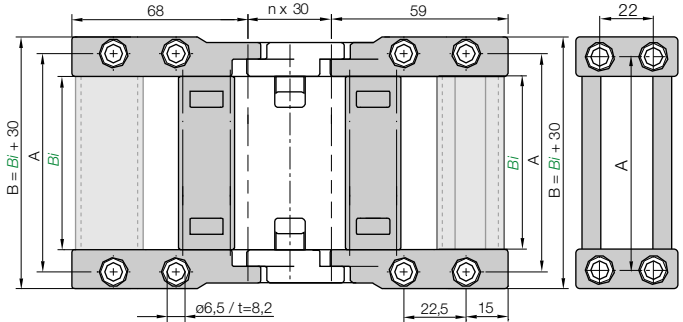

Phone +49- (0) 22 03-96 49-800  
Fax +49- (0) 22 03-96 49-222

**Part No. structure**

E6.520.040.12.C

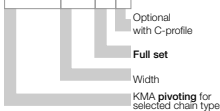

- Full set, for both ends:  
E6.520.040.12.C (with C-profile)
- Single-part order:  
E6.520.040.1.C (with C-profile)
- Fixed end mounting bracket  
E6.520.040.2.C (with C-profile)
- Moving end mounting bracket

For E-Chain®	Part No. full set optional with C-profile	Dim. A [mm]	Dim. B [mm]
E6.52.040.	E6.520.040.12.C	56	70
E6.52.050.	E6.520.050.12.C	66	80
E6.52.062.	E6.520.062.12.C	78	92
E6.52.070.	E6.520.070.12.C	86	100
E6.52.075.	E6.520.075.12.C	91	105
E6.52.087.	E6.520.087.12.C	103	117
E6.52.100.	E6.520.100.12.C	116	130
E6.52.125.	E6.520.125.12.C	141	155

For E-Chain®	Part No. full set optional with C-profile	Dim. A [mm]	Dim. B [mm]
E6.52.150.	E6.520.150.12.C	166	180
E6.52.175.	E6.520.175.12.C	191	205
E6.52.200.	E6.520.200.12.C	216	230
E6.52.225.	E6.520.225.12.C	241	255
E6.52.250.	E6.520.250.12.C	266	280
E6.52.275.	E6.520.275.12.C	291	300
E6.52.300.	E6.520.300.12.C	316	330

igus® GmbH  
51147 Cologne

**Other strain relief elements**

System E6 | E-Tube | **Series R6.52** | Accessories | Strain Relief

Strain relief tiwrap plate can be fixed on the last crossbar, alternatively with C-profile. Tiwrap plate as individual part - Part No. 30XX.ZB. Further strain relief elements ► chapter 10



Other strain relief elements - optional ► chapter 10



Internet: www.igus.de  
E-mail: info@igus.de

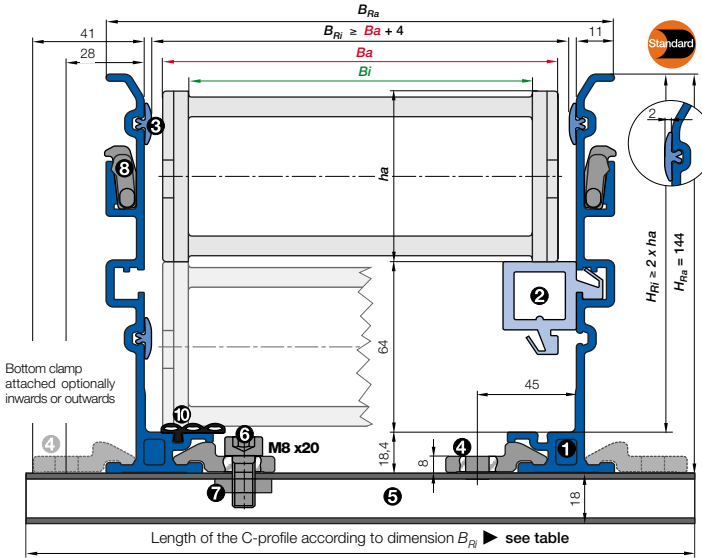

- $B_a$  = Outer width E-Chains\* / E-Tube
- $B_i$  = Inner width E-Chains\* / E-Tube
- $h_a$  = Outer height E-Chains\* / E-Tube
- $H_{Ri}$  = Inner trough height
- $H_{Ra}$  = Outer trough height
- $B_{Ri}$  = Inner trough width ► depends on dim.  $B_a$
- $B_{Ra}$  = Outer trough width
- $n_{Mon}$  = Number of installation sets (left/right)
- $n_{Ri}$  = Number of trough sets (left/right)
- !  $H_{Ri} \geq 2 \cdot h_a$
- !  $B_{Ri} \geq B_a + 4$
- = Guide trough set      ● = Glide bar
- = Installation set "Basic"      ● = C-profile

**Installation set "Basic" with C-profile**

Bottom Clamp attached optionally inwards or outwards

E6.52.040.200.0 ► Order example

$B_{Ri}$ [mm]	Part No.		Part No.	
	attached inwards	attached outwards	attached inwards	attached outwards
.040	68	-	960.40.200	
.050	78	-	960.40.200	
.062	90	-	960.40.225	
.070	98	-	960.40.225	
.075	103	-	960.40.225	
.100	128	960.40.175	960.40.250	
.125	153	960.40.200	960.40.275	
.150	178	960.40.225	960.40.300	
.175	203	960.40.250	960.40.325	
.200	228	960.40.275	960.40.350	
.225	253	960.40.300	960.40.375	
.250	278	960.40.325	960.40.400	
.275	303	960.40.350	960.40.425	
.300	328	960.40.375	960.40.450	



- **Components, trough "Basic":** ① Trough side parts, aluminum, 2 m ② Glide bar, plastic, 2 m ③ Glide strips, plastic, 2 m (without glide strips on request) ⑩ Optional: Silencer profile, rubber
- **Components, installation set "Basic":** ④ Bottom clamp, aluminum ⑤ C-profile, steel galvanized ⑥ Screw M8 x20 ⑦ Sliding nut M8 ⑧ Interface connector, plastic

**Order example: Length of travel 30 m - Center mounted for Series E6.52.100.200.0 with  $B_{Ri} = 128$**

Guide trough set (set of 2 trough side parts, incl. glide strips) <b>without</b> glide bar	Part No.	973.30.SL
Order text: 16 m guide trough without glide bar (8 x 2 m sections)		
Guide trough set (set of 2 trough side parts, incl. glide strips) <b>with</b> glide bar	Part No.	973.31.SL
Order text: 16 m guide trough with glide bar (8 x 2 m sections)		
Installation set "Basic" complete (guide trough-sets + 1)	Part No.	960.40.175
Order text: 17 installation sets "Basic"		
Module for the fixed end	Part No.	973.80
Order text: 1 set		
Option: For an additional noise dampening with silencer profile, please add Index A - Example:	Part No.	973.30.SLA



Principle sketch: Number of installation sets to be installed = **Number of trough sections + 1**

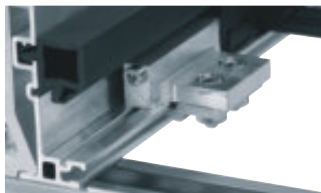

**NEW! A quick fix for mounting the stationary end of an E-Chain\***

With this new module for the fixed end, fast and easy mounting onto the Aluminum "SuperTrough" is now possible without any drilling. Fast mounting of the E-Chain\* by clamping onto the aluminum trough

- Quick relocation of the stationary end
- No drilling necessary ► page 9.16

Insert for the installation set "Heavy-Duty": **973.50.XXX** instead of (960.40.XXX) on the right column "attached outwards"

Tel. +49- (0) 22 03-96 49-800  
 Fax +49- (0) 22 03-96 49-222



► page 8.39



Price index



Extremely low noise  
Test results upon request



Cleanroom test  
upon request



ATEX-ESD Standard Material: igamid G  
- ESD compatibility Level 1 according to SEMI E78-0998 ESD igamid ESD special material (upon request): Superior long-term conductivity due to lack of pin and bore tolerances (no air gaps)



Lever and remove lids



When to use the Series R6.52:

- Protection against dirt and chips
- If a low-noise version is required
- At very high speeds and/or accelerations
- For enlarged thrusts and tensile forces
- For small bending radii
- If less vibration is required
- Minimal abrasion  
(e.g. cleanroom applications)



When not to use it:

- Limited in side-mounted applications  
▶ Series R7838 System E4, page 7.104

- 1 No pin and bore connection
- 2 Can be shortened or lengthened due to modular design
- 3 Small pitch for low-noise, smooth operation
- 4 Continuous glide surfaces
- 5 Smooth, cable-protecting inner chamber
- 6 Interior stop dog
- 7 Very large gliding surfaces
- 8 Enclosed design protects from light debris, weld splatter and compromising environmental influences
- 9 KMA-Mounting Brackets with attachment points on all sides
- 10 Optional with or without integrated C-profile

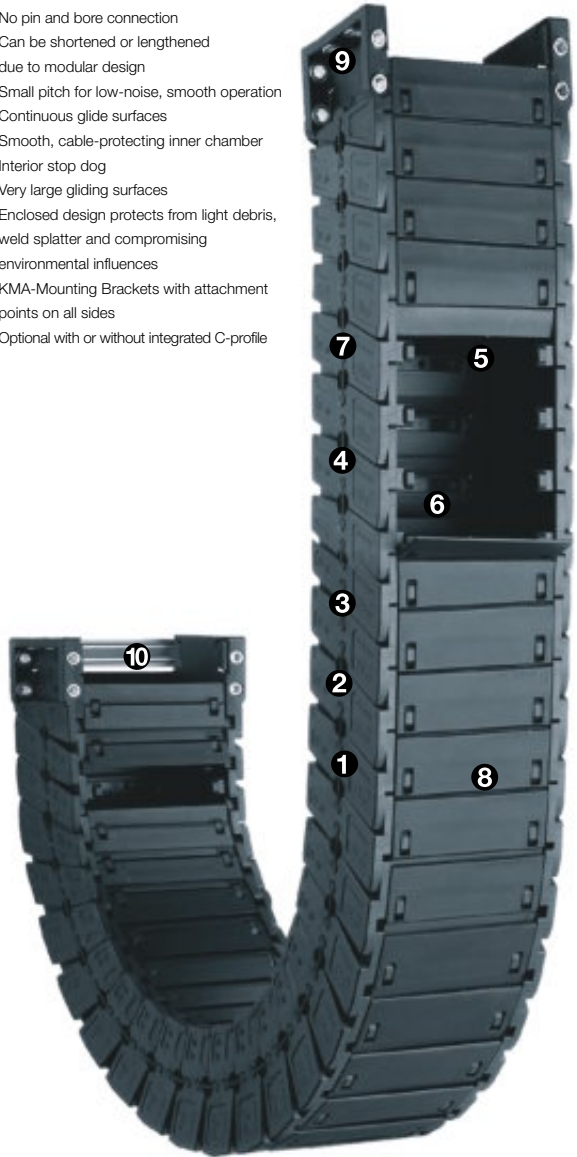

Order example complete E-Chain®

Please indicate chain-lengths or number of links Example: 2 m or 68 links

2 m R6.52.100.075.0



E-Tube

with 2 separators R6.52.11 assembled every 2<sup>nd</sup> link

Interior separation

1 set R6.520.100.12



Mounting bracket

**Unsupported length**

$FL_G$  = with straight upper run  
 $FL_B$  = with permitted sag  
 Further information ► **Design, page 1.12**

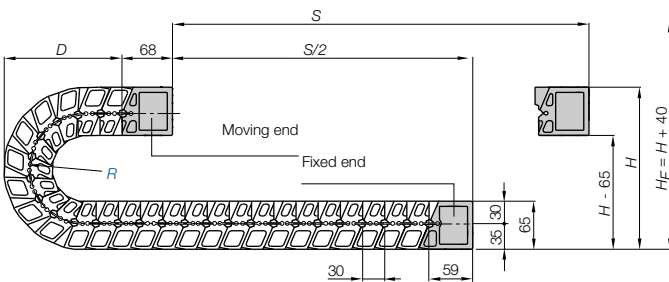
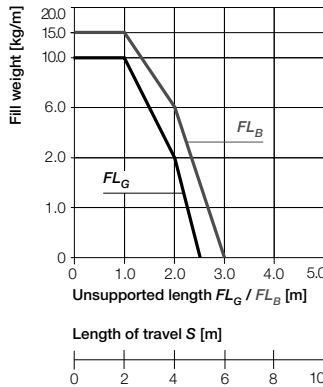
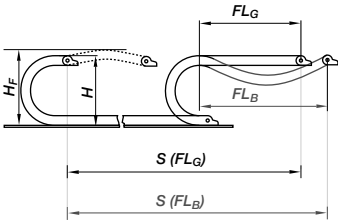

**Pitch = 30 mm/link Links/m = 34 (1020 mm) Chain length =  $S/2 + K$**

<b>R</b>	075	100	150	200	250
<b>H</b>	220	270	370	470	570
<b>D</b>	140	165	215	265	315
<b>K</b>	300	375	535	690	850
<b>D<sub>2</sub><sup>+25</sup></b>	270	398	768	1138	1508
<b>K<sub>2</sub></b>	300	480	990	1470	1950

- S** = Length of travel
- R** = Bending radius
- H** = Nominal clearance height
- H<sub>F</sub>** = Required clearance height
- H<sub>tr</sub>** = Trough inner height
- D** = Overlength E-Chain® radius in final position
- K** =  $\pi \cdot R$  + "safety"
- D<sub>2</sub>** = Over length for long travels gliding
- K<sub>2</sub>** = Further add-on if the mounting bracket location is set lower

**Other installation methods**

- Vertical, hanging  $\leq 50$  m
- Vertical, standing  $\leq 2$  m
- Side mounted, unsupported = possible to a limited extent
- Unsupported length of upper run = upon request



**Short travels - unsupported**

Unsupported E-Chains® feature positive camber over short travels. This must be accounted for when specifying the clearance height  $H_F$ . Please consult igus® if space is particularly restricted.

The required clearance height:  
 **$H_F = H + 40$  mm**  
 (with 2,0 kg/m fill weight)

**Long travel lengths from 6 m to max. 80 m Chain length =  $S/2 + K_2$**

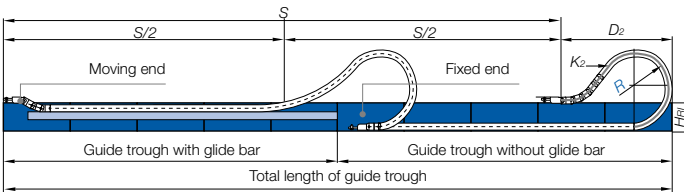

In case of travels between 4 m and 6 m we recommend a longer unsupported length.



**Gliding, long travel applications (max. 80 m)**

In this case the E-Chain® upper run will be introduced in a guide trough on the lower run. We recommend to realize the engineering of such a plant by our technicians.

Speed / acceleration $FL_G$	max. 20 [m/s] / max. 200 [m/s <sup>2</sup> ]
Speed / acceleration $FL_B$	max. 3 [m/s] / max. 6 [m/s <sup>2</sup> ]
Gliding speed / acceleration (maximum)	upon request
permitted temperature °C	-40° up to +100° C
Flammability class	VDE 0304 IIC UL94 HB

**Technical Data**



Details of material properties  
 ► page 1.38

System E6  
 Inner height: 52 mm

Phone +49- (0) 22 03-96 49-800  
 Fax +49- (0) 22 03-96 49-222



► page 8.39

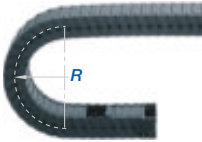
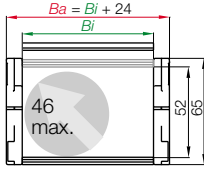

Part No. structure

R6.52.100.075.0



**Serie R6.52 E-Tube, lids can be removed along inner and outer radius**

Part No.	Bi [mm]	Ba [mm]	R [mm]	Bending radii				Weight [kg/m]
R6.52.050.□.0	50	74	075	100	150	200	250	~ 1,89
R6.52.075.□.0	75	99	075	100	150	200	250	~ 2,12
R6.52.100.□.0	100	124	075	100	150	200	250	~ 2,35
R6.52.125.□.0	125	149	075	100	150	200	250	~ 2,57
R6.52.150.□.0	150	174	075	100	150	200	250	~ 2,80
R6.52.175.□.0	175	199	075	100	150	200	250	~ 3,03

The widths 040 / 062 / 087 / 200 / 225 / 250 / 275 / 300 are available upon request.

Time of delivery approx. 6-8 weeks after order.

Supplement Part No. with required radius. Example: R6.52.100.075.0

0 = standard color, other colors ▶ page 1.39 · Pitch = 30 mm/link - Links/m = 34



Trennsteg

unassembled R6.52.01  
assembled R6.52.11



System E6 | E-Tube | **Series R6.52** | Accessories | Interior Separation

**Option 1: Vertical separators**

Vertical separators are used if a vertical subdivision of the E-Chain® interior is required -  
By standard vertical separators are assembled every other E-Chain® link!

- The notches on this separator marks the sticking side for a stuck mounting on the lid
- Standard subdivision with vertical separator R6.52.11



Separator,  
R6.52.01  
(side view)

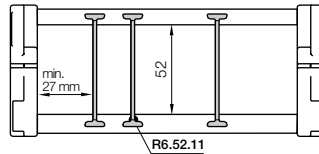

igus® System E6 harnessed in a printing machine. Clear separation due to the igus® separator-program



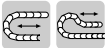

\* KMA = Polymer Metal Mounting Bracket

### Option KMA\* - pivoting

- Option - integrated C-profile strain relief device with Chainfix clip or strain relief tiwrap plates
- C-profile mountable in the inner or outer radius of the E-Chain®
- Bolted connection outside of chain cross-section
- Recommended for unsupported and gliding applications
- Confined installation conditions
- Universal mountable with attachment capability on all sides

Moving end  
R6.520...2

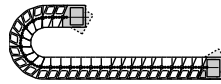

The attachment variants arising automatically by the choice of the KMA mounting bracket

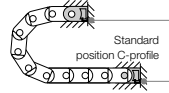

R6.520...2

Fixed end

R6.520...1

Moving end

### Dimensions and order configurations

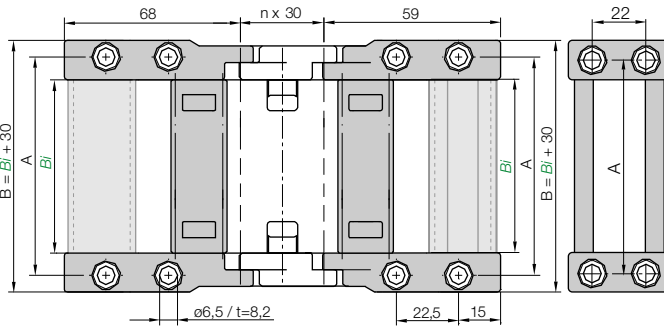

For E-Chain®	Part No. full set optional with C-profile	Dim. A [mm]	Dim. B [mm]
R6.52.050. ▶	R6.520.050.12.C	66	80
R6.52.075. ▶	R6.520.075.12.C	91	105
R6.52.100. ▶	R6.520.100.12.C	116	130

For E-Chain®	Part No. full set optional with C-profile	Dim. A [mm]	Dim. B [mm]
R6.52.125. ▶	R6.520.125.12.C	141	155
R6.52.150. ▶	R6.520.150.12.C	166	180
R6.52.175. ▶	R6.520.175.12.C	191	205

Part No. structure

R6.520.040.12.C

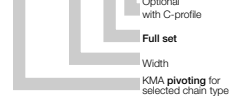

Full set, for both ends:

R6.520.040.12.C (with C-profile)

Single-part order:

R6.520.040.1.C (with C-profile)

Fixed end mounting bracket

R6.520.040.2.C (with C-profile)

Moving end mounting bracket

Phone +49- (0) 22 03-96 49-800  
Fax +49- (0) 22 03-96 49-222

### System E6 | E-Tube | Series R6.52 | Accessories | Strain Relief

Strain relief tiwrap plate can be fixed on the last crossbar, alternatively with C-profile. Tiwrap plate as individual part - Part No. 30XX.ZB. Further strain relief elements ▶ chapter 10



Other strain relief elements - optional ▶ chapter 10



Trough E6.52 ▶ page 8.71



▶ page 8.39





Price index



Extremely low noise  
Test results upon request



Cleanroom test  
upon request



ATEX-ESD Standard Material: igumid G  
- ESD compatibility Level 1 according  
to SEMI E78-0998 ESD igumid ESD  
special material (upon request); Superior  
long-term conductivity due to lack of  
pin and bore tolerances (no air gaps)



To close, push and click shut



When to use the Series E6.62:

- If a low-noise version is required
- At very high speeds and/or accelerations
- For enlarged thrusts and tensile forces
- For small bending radii
- If less vibration is required
- Minimal abrasion  
(e.g. cleanroom applications)



When not to use it:

- Limited in side-mounted applications  
▶ Series 4040 System E4, page 7.116
- No use with RBR (reverse bending radius)  
▶ Series 4040 System E4, page 7.116
- No use with high additional loads  
▶ Series 4040 System E4, page 7.116
- No use in dirty environments  
▶ Series 4040 System E4, page 7.116

- ① No pin and bore connection
- ② Interior stop dog
- ③ Small pitch for low-noise, smooth operation
- ④ Can be shortened or lengthened due to modular design
- ⑤ Very large gliding surfaces
- ⑥ Increased inner height
- ⑦ KMA-Mounting Brackets with attachment points on all sides
- ⑧ Optional with or without integrated C-profile
- ⑨ Series R6.62 - E-Tube-version available on request

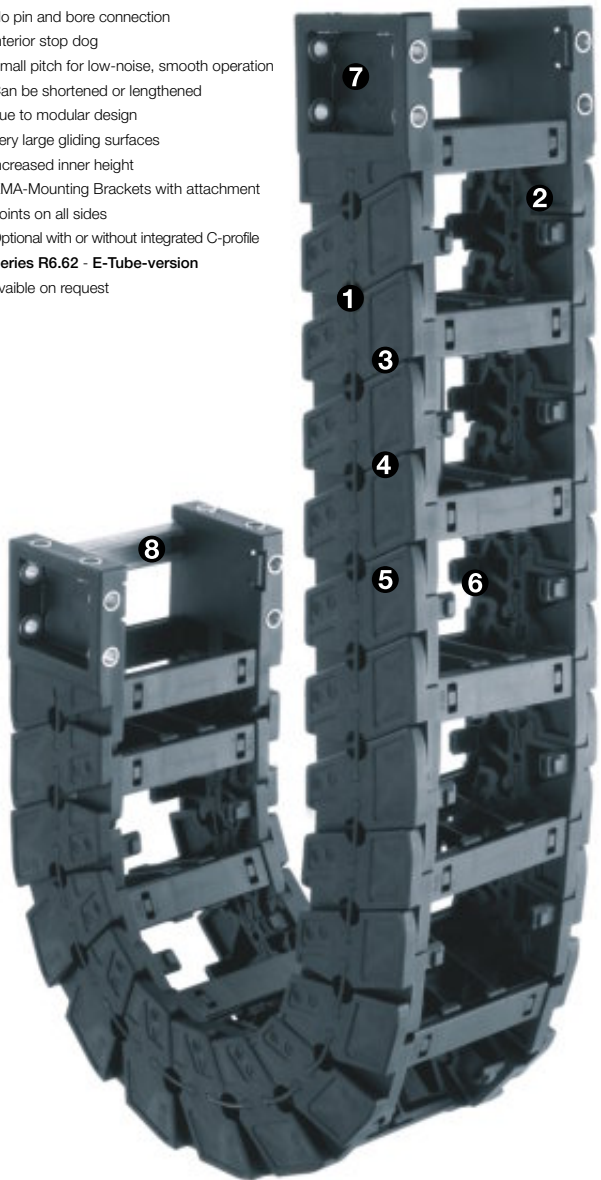

Order example complete E-Chain®

Please indicate chain-lengths or number of links Example: 3 m or 60 links

3 m E6.62.10.200.0

E-Chain®

with 2 separators E6.62.11 assembled every 2<sup>nd</sup> link

Interior separation

1 set E6.620.10.12C

Mounting bracket

**Unsupported length**

$FL_G$  = with straight upper run

$FL_B$  = with permitted sag

Further information ► **Design, page 1.12**

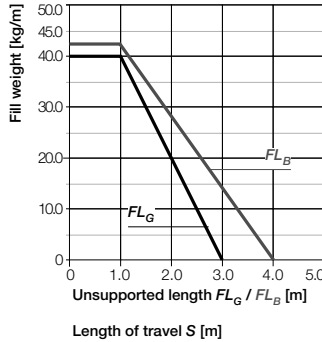
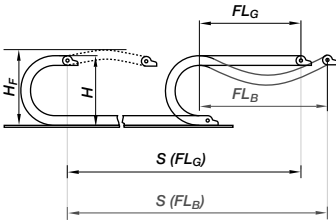

- $S$  = Length of travel
- $R$  = Bending radius
- $H$  = Nominal clearance height
- $H_F$  = Required clearance height
- $H_{in}$  = Trough inner height
- $D$  = Overlength E-Chain® radius in final position
- $K$  =  $\pi \cdot R$  + "safety"
- $D_2$  = Over length for long travels gliding
- $K_2$  = Further add-on if the mounting bracket location is set lower

**Other installation methods**

- Vertical, hanging  $\leq 60$  m
- Vertical, standing  $\leq 3$  m
- Side mounted, unsupported = possible to a limited extent
- Unsupported length of upper run = upon request

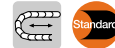

**Short travels - unsupported**

Unsupported E-Chains® feature positive camber over short travels. This must be accounted for when specifying the clearance height  $H_F$ . Please consult igus® if space is particularly restricted.

The required clearance height:

$H_F = H + 80$  mm  
(with 2,0 kg/m fill weight)

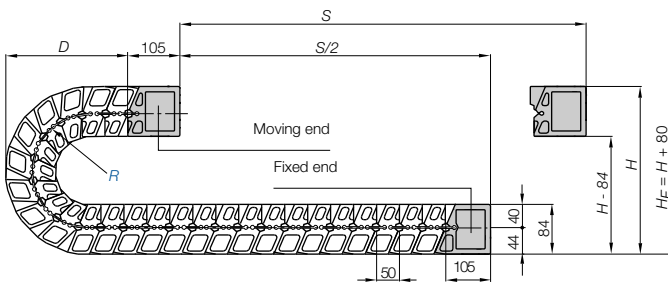

Pitch = 50 mm/link Links/m = 20 (1000 mm) Chain length =  $S/2 + K$

R	115	150	200	250	300	350
H	318	388	488	588	688	788
D	209	244	294	344	394	444
K	465	575	730	890	1045	1200
$D_2^{+25}$	463	498	1012	1314	1616	1918
$K_2$	550	650	1300	1700	2150	2600

Long travel lengths from 10 m to max. 100 m Chain length =  $S/2 + K_2$

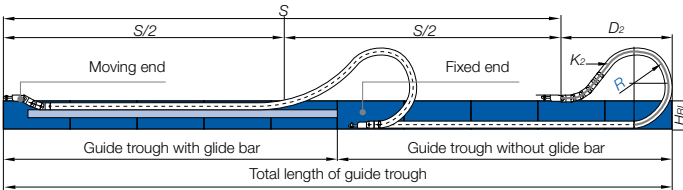

In case of travels between 4 m and 10 m we recommend a longer unsupported length.



**Gliding, long travel applications (max. 100 m)**

In this case the E-Chain® upper run will be introduced in a guide trough on the lower run. We recommend to realize the engineering of such a plant by our technicians.

Speed / acceleration $FL_G$	max. 20 [m/s] / max. 200 [m/s <sup>2</sup> ]
Speed / acceleration $FL_B$	max. 3 [m/s] / max. 6 [m/s <sup>2</sup> ]
Gliding speed / acceleration (maximum)	upon request
permitted temperature °C	-40° up to +100° C
Flammability class	VDE 0304 IIC UL94 HB

**Technical Data**



Details of material properties  
► page 1.38

System E6  
Inner height: 62 mm

Phone +49- (0) 22 03-96 49-800  
Fax +49- (0) 22 03-96 49-222

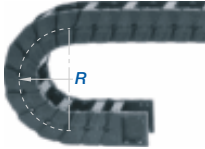
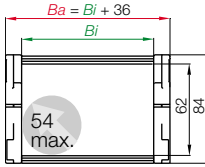

► page 8.39

Series E6.62 - with crossbars every 2<sup>nd</sup> link

Part No.	Bi [mm]	Ba [mm]	R [mm]	Bending radii					Weight [kg/m]
E6.62.05.	50	86	115	150	200	250	300	350	≈ 3,22
E6.62.06.	68	104	115	150	200	250	300	350	≈ 3,28
E6.62.07.	75	111	115	150	200	250	300	350	≈ 3,31
E6.62.087.	87	123	115	150	200	250	300	350	≈ 3,35
E6.62.10.	100	136	115	150	200	250	300	350	≈ 3,39
E6.62.11.	108	144	115	150	200	250	300	350	≈ 3,42
E6.62.112.	112	148	115	150	200	250	300	350	≈ 3,43
E6.62.12.	125	161	115	150	200	250	300	350	≈ 3,48
E6.62.137.	137	173	115	150	200	250	300	350	≈ 3,52
E6.62.15.	150	186	115	150	200	250	300	350	≈ 3,57
E6.62.162.	162	198	115	150	200	250	300	350	≈ 3,61
E6.62.17.	168	204	115	150	200	250	300	350	≈ 3,63
E6.62.18.	175	211	115	150	200	250	300	350	≈ 3,65
E6.62.187.	187	223	115	150	200	250	300	350	≈ 3,69
E6.62.20.	200	236	115	150	200	250	300	350	≈ 3,74
E6.62.212.	212	248	115	150	200	250	300	350	≈ 3,78
E6.62.23.	225	261	115	150	200	250	300	350	≈ 3,83
E6.62.237.	237	273	115	150	200	250	300	350	≈ 3,87
E6.62.25.	250	286	115	150	200	250	300	350	≈ 3,91
E6.62.262.	262	298	115	150	200	250	300	350	≈ 3,95
E6.62.28.	275	311	115	150	200	250	300	350	≈ 4,00
E6.62.29.	287	323	115	150	200	250	300	350	≈ 4,04
E6.62.30.	300	336	115	150	200	250	300	350	≈ 4,09
E6.62.312.	312	348	115	150	200	250	300	350	≈ 4,13
E6.62.325.	325	361	115	150	200	250	300	350	≈ 4,17
E6.62.337.	337	373	115	150	200	250	300	350	≈ 4,21
E6.62.350.	350	386	115	150	200	250	300	350	≈ 4,26
E6.62.362.	362	398	115	150	200	250	300	350	≈ 4,30
E6.62.375.	375	411	115	150	200	250	300	350	≈ 4,35
E6.62.387.	387	423	115	150	200	250	300	350	≈ 4,39
E6.62.400.	400	436	115	150	200	250	300	350	≈ 4,43

Supplement Part No. with required radius. Example: E6.62.237.150.0

0 = standard color, other colors ► page 1.39 · Pitch = 50 mm/link - Links/m = 20

Part No. structure

E6.62.237.150.0

## Part No. E-Chain® - links, single parts

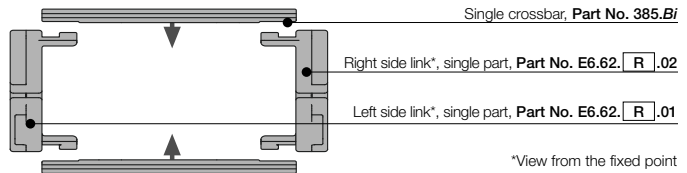

\*View from the fixed point

### Option 1: Vertical separators and spacers

Vertical separators are used if a vertical subdivision of the E-Chain® interior is required -

By standard vertical separators are assembled every other E-Chain® link

- **Standard separator 417** offers safe stability due to its wide base design, even when used with large diameter cables or hoses
- If a broad distance shall be kept between the separators or they have to be fixed in their position, e.g. in case of side mounted applications, **Spacers 382.10, 382.15 and 382.20** can be used

**Instruction:** The available interior height is reduced by 2 mm per spacer, and can hence amount to 4 mm when spacers are fitted on both sides. To avoid this, the parts can also be installed from the outside on the opening crossbar. (no long travels)

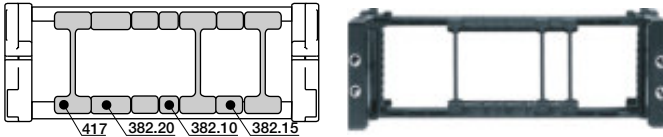

Vertical separator	
unassembled	407
assembled	417

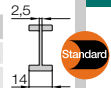

Spacer*	
unassembled	381.10
assembled	382.10
unassembled	381.15
assembled	382.15
unassembled	381.20
assembled	382.20

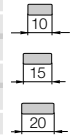

\* for side-mounted applications

System E6  
Inner height: 62 mm

### Option 2: Full-width shelves

For applications involving many thin cables with similar or identical diameters

- **Vertical separator, slotted E6.62.11** - for applications with full-width shelf 321.X

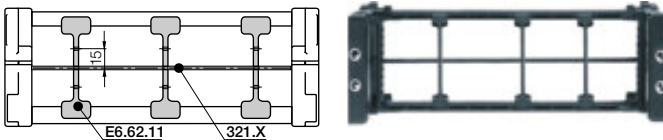

Width X [mm]	Part No. unassembled	Part No. assembled
50	320.050	321.050
75	320.075	321.075
100	320.100	321.100
115	320.115	321.115
125	320.125	321.125

Width X [mm]	Part No. unassembled	Part No. assembled
150	320.150	321.150
175	320.175	321.175
200	320.200	321.200
225	320.225	321.225
250	320.250	321.250

Vertical separator, slotted	
unassembled	E6.62.01
assembled	E6.62.11



Full-width shelf	
Width	X-1
Thickness	t = 3,4

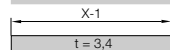

Phone +49- (0) 22 03-96 49-800  
Fax +49- (0) 22 03-96 49-222

### Option 3: Shelves

Shelves can be arranged elevator-shifted with different bottoms within the entire E-Chain® width

They can be arranged at 7 different heights (in 7 mm increments)

- Shelf 387.X can be combined with middle plate 149 and side plate 147
- ▶ Design, chapter 1 for layout recommendations.
- **Slotted separators 1417** are used for complex subdivisions.

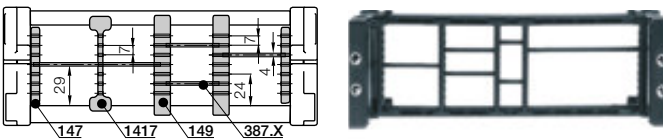

Width X [mm]	Part No. unassembled	Part No. assembled
18	386.18	387.18
23	386.23	387.23
25	386.25	387.25
28	386.28	387.28
33	386.33	387.33
43	386.43	387.43
50	386.50	387.50
54	386.54	387.54
62	386.62	387.62

Width X [mm]	Part No. unassembled	Part No. assembled
75	386.75	387.75
87	386.87	387.87
100	386.100	387.100
108	386.108	387.108
125	386.125	387.125
150	386.150	387.150
175	386.175	387.175
200	386.200	387.200
208	386.208	387.208

Middle plate	
unassembled	148
assembled	149



Side plate	
unassembled	146
assembled	147



Slotted separator**	
unassembled	1407
assembled	1417



\*\*retrofit of an existing interior shelving not possible without disassembling of the parts

Shelf	
Width	X - 8
Thickness	t = 4

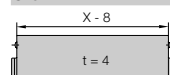



The attachment variants arising automatically by the choice of the KMA mounting bracket

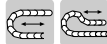
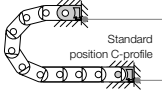

\* KMA = Polymer Metal Mounting Bracket

**Option KMA\* - pivoting**

- Option - integrated C-profile strain relief device with Chainfix clip or strain relief tiwrap plates
- C-profile mountable in the inner or outer radius of the E-Chain®
- Bolted connection outside of chain cross-section
- Recommended for unsupported and gliding applications
- Confined installation conditions
- Universal mountable with attachment capability on all sides

Moving end  
E6.620...2

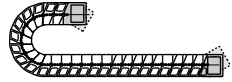

E6.620...1  
Fixed end

**Dimensions and order configurations**



Adapters for gliding applications available upon request

E6.620...2  
Moving end

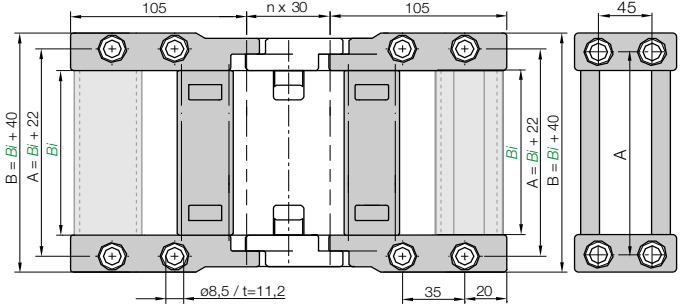

E6.620...1  
Fixed end

Phone +49- (0) 22 03-96 49-800  
Fax +49- (0) 22 03-96 49-222

igus® GmbH  
51147 Cologne

**Part No. structure**

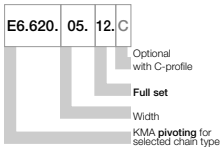

Full set, for both ends:

[E6.620.05.12.C] (with C-profile)

Single-part order:

[E6.620.05.1.C] (with C-profile)

Fixed end mounting bracket

[E6.620.05.2.C] (with C-profile)

Moving end mounting bracket

For E-Chain®	Part No. full set optional with C-profile	Bi [mm]
E6.62.05.	E6.620.05.12. C	50
E6.62.06.	E6.620.06.12. C	68
E6.62.07.	E6.620.07.12. C	75
E6.62.087.	E6.620.087.12. C	087
E6.62.10.	E6.620.10.12. C	100
E6.62.11.	E6.620.11.12. C	108
E6.62.112.	E6.620.112.12. C	112
E6.62.12.	E6.620.12.12. C	125
E6.62.137.	E6.620.137.12. C	137
E6.62.15.	E6.620.15.12. C	150
E6.62.162.	E6.620.162.12. C	162
E6.62.17.	E6.620.17.12. C	168
E6.62.18.	E6.620.18.12. C	175
E6.62.187.	E6.620.187.12. C	187
E6.62.20.	E6.620.20.12. C	200
E6.62.212.	E6.620.212.12. C	212

For E-Chain®	Part No. full set optional with C-profile	Bi [mm]
E6.62.23.	E6.620.23.12. C	225
E6.62.237.	E6.620.237.12. C	237
E6.62.25.	E6.620.25.12. C	250
E6.62.262.	E6.620.262.12. C	262
E6.62.28.	E6.620.28.12. C	275
E6.62.29.	E6.620.29.12. C	287
E6.62.30.	E6.620.30.12. C	300
E6.62.312.	E6.620.312.12. C	312
E6.62.325.	E6.620.325.12. C	325
E6.62.337.	E6.620.337.12. C	337
E6.62.350.	E6.620.350.12. C	350
E6.62.362.	E6.620.362.12. C	362
E6.62.375.	E6.620.375.12. C	375
E6.62.387.	E6.620.387.12. C	387
E6.62.400.	E6.620.400.12. C	400

Internet: [www.igus.de](http://www.igus.de)  
E-mail: [info@igus.de](mailto:info@igus.de)

System E6 | E-Tube | Series E6.62 | Accessories | Strain Relief

Strain relief tiwrap plate can be fixed on the last crossbar, alternatively with C-profile. Tiwrap plate as individual part - Part No. 30XX.ZB. Further strain relief elements ► chapter 10



Other strain relief elements - optional ► chapter 10



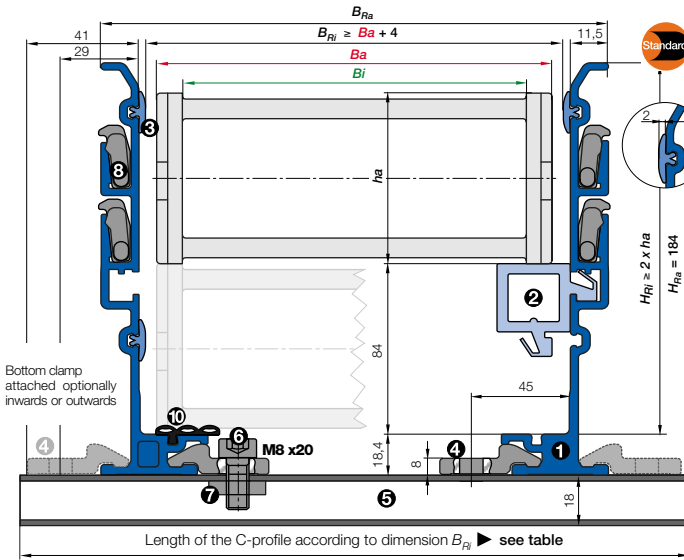

- $B_a$  = Outer width E-Chains\* / E-Tube
  - $B_i$  = Inner width E-Chains\* / E-Tube
  - $h_a$  = Outer height E-Chains\* / E-Tube
  - $H_{Ri}$  = Inner trough height
  - $H_{Ra}$  = Outer trough height
  - $B_{Ri}$  = Inner trough width ► depends on dim.  $B_a$
  - $B_{Ra}$  = Outer trough width
  - $n_{Mon}$  = Number of installation sets (left/right)
  - $n_{Ri}$  = Number of trough sets (left/right)
- $H_{Ri} \geq 2 \cdot h_a$   
 $B_{Ri} \geq B_a + 4$
- = Guide trough set
  - = Installation set "Basic"
  - = Glide bar
  - = C-profile

**Installation set "Basic" with C-profile**

Bottom Clamp attached optionally inwards or outwards ►

E6.62.05.200.0 ► Order example

$B_{Ri}$ [mm]	attached inwards	attached outwards	Part No.	Part No.
.05	90	-	960.50.225	
.06	108	-	960.50.225	
.07	115	-	960.50.250	
.087	127	960.50.175	960.50.250	
.10	140	960.50.200	960.50.275	
.11	148	960.50.200	960.50.275	
.112	152	960.50.200	960.50.275	
.12	165	960.50.225	960.50.300	
.137	177	960.50.225	960.50.300	
.15	190	960.50.250	960.50.325	
.162	202	960.50.250	960.50.325	
.17	208	960.50.275	960.50.325	
.18	215	960.50.275	960.50.350	
.187	227	960.50.275	960.50.350	
.20	240	960.50.300	960.50.375	
.212	252	960.50.300	960.50.375	
.23	265	960.50.325	960.50.400	
.237	277	960.50.325	960.50.400	
.25	290	960.50.350	960.50.425	
.262	302	960.50.350	960.50.425	
.28	315	960.50.375	960.50.450	
.29	327	960.50.375	960.50.450	
.30	340	960.50.400	960.50.475	
.312	352	960.50.400	960.50.475	
.325	365	960.50.425	960.50.500	
.337	377	960.50.425	960.50.500	
.350	390	960.50.450	960.50.525	
.362	402	960.50.450	960.50.525	
.375	415	960.50.475	960.50.550	
.387	427	960.50.475	960.50.550	
.400	440	960.50.500	960.50.575	



- **Components, trough "Basic":** ① Trough side parts, aluminum, 2 m ② Glide bar, plastic, 2 m ③ Glide strips, plastic, 2 m (without glide strips on request) ⑩ Optional: Silencer profile, rubber
- **Components, installation set "Basic":** ④ Bottom clamp, aluminum ⑤ C-profile, steel galvanized ⑥ Screw M8 x20 ⑦ Sliding nut M8 ⑧ Interface connector, plastic



**Order example: Length of travel 30 m - Center mounted for Series E6.62.087.200.0 with  $B_{Ri} = 127$**

Guide trough set (set of 2 trough side parts, incl. glide strips) <b>without</b> glide bar	Part No.	974.30.SL
Order text: 16 m guide trough without glide bar (8 x 2 m sections)		
Guide trough set (set of 2 trough side parts, incl. glide strips) <b>with</b> glide bar	Part No.	974.31.SL
Order text: 16 m guide trough with glide bar (8 x 2 m sections)		
Installation set "Basic" complete (guide trough-sets + 1)	Part No.	960.50.200
Order text: 17 installation sets "Basic"		
Module for the fixed end	Part No.	975.80
Order text: 1 set		
Option: For an additional noise dampening with silencer profile, please add Index A - Example:	Part No.	974.30.SLA

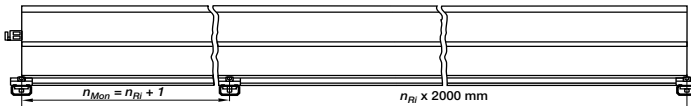

Principle sketch: Number of installation sets to be installed = **Number of trough sections + 1**

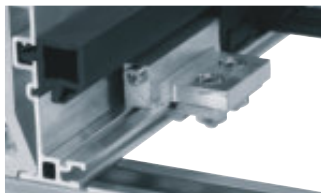

**NEW! A quick fix for mounting the stationary end of an E-Chain®**

With this new module for the fixed end, fast and easy mounting onto the Aluminum "SuperTrough" is now possible without any drilling. Fast mounting of the E-Chain® by clamping onto the aluminum trough

- Quick relocation of the stationary end
- No drilling necessary ► page 9.16

Insert for the installation set "Heavy-Duty": **974.50.XXX** instead of (960.50.XXX) on the right column "attached outwards"







Price index



**Extremely low noise**  
Test results upon request



**Cleanroom test**  
upon request



**ATEX-ESD Standard Material: igumid G**  
- ESD compatibility Level 1 according to SEMI E78-0998 ESD igumid ESD special material (upon request); Superior long-term conductivity due to lack of pin and bore tolerances (no air gaps)



To close, push and click shut



#### When to use the Series E6.80L:

- If a low-noise version is required
- At very high speeds and/or accelerations
- For enlarged thrusts and tensile forces
- For small bending radii
- If less vibration is required
- Minimal abrasion  
(e.g. cleanroom applications)



#### When not to use it:

- Limited in side-mounted applications
  - ▶ Series 15050 System E4/light, page 7.182
- No use with RBR (reverse bending radius)
  - ▶ Series 15050 System E4/light, page 7.182
- No use with high additional loads
  - ▶ Series 15050 System E4/light, page 7.182

- ① 45% lighter in weight compared to the Series E6.80
- ② Can be shortened or lengthened due to modular design
- ③ Continuous glide surfaces
- ④ No pin and bore connection
- ⑤ Interior stop dog
- ⑥ Small pitch for low-noise, smooth operation
- ⑦ KMA mounting brackets with attachment points on all sides (strain relief with separate tiewrap plates possible)
- ⑧ Increased inner height
- ⑨ Optional with or without integrated C-profile

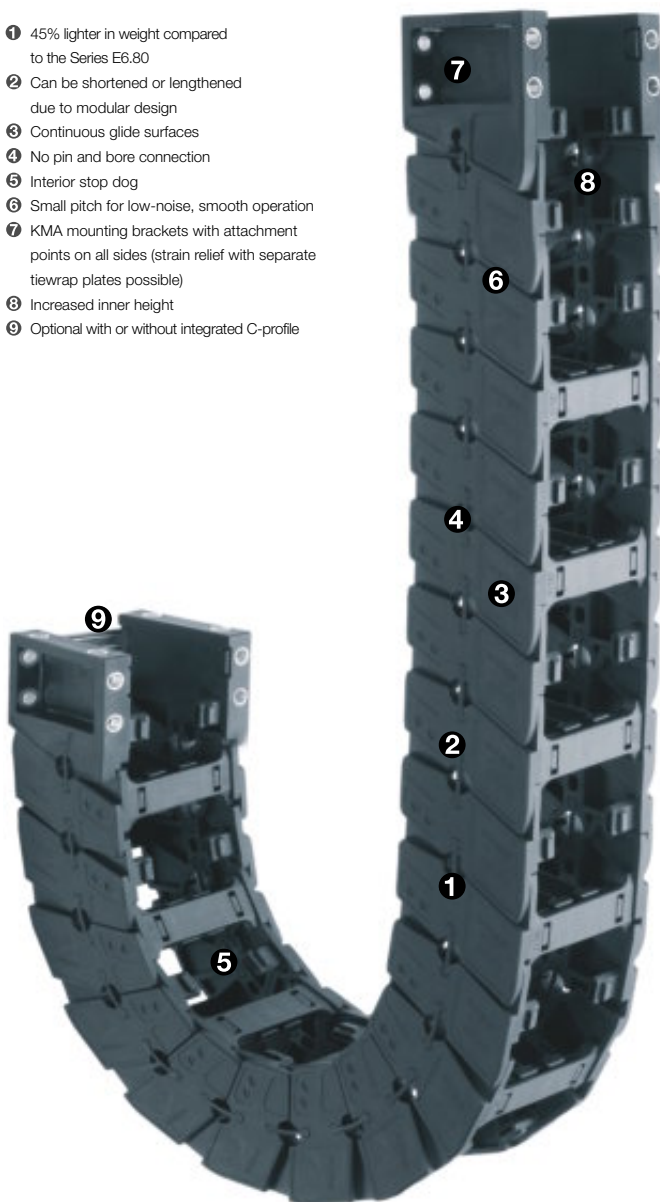

#### Order example complete E-Chain®

Please indicate chain-lengths or number of links **Example: 5 m or 80 links**

5 m **E6.80L.15.175.0**

 **E-Chain®**

with 2 separators **511** assembled every 2<sup>nd</sup> link

 **Interior separation**

1 set **E6.800L.15.12**

 **Mounting bracket**



**Unsupported length**

$FL_G$  = with straight upper run

$FL_B$  = with permitted sag

Further information ► **Design, page 1.12**

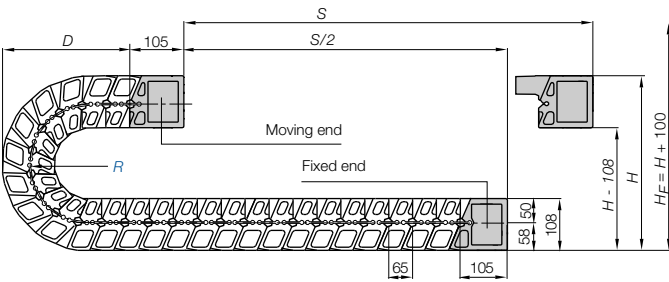
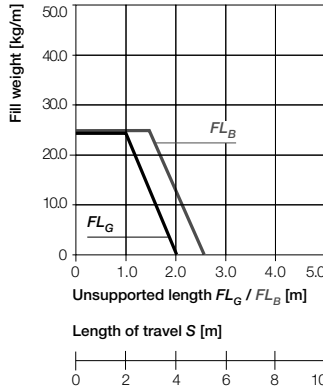
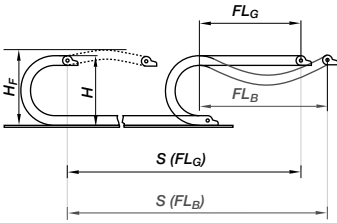

**Pitch = 65 mm/link Links/m = 16 (1040 mm) Chain length =  $S/2 + K$**

<b>R</b>	175
<b>H</b>	466
<b>D</b>	298
<b>K</b>	680

- S** = Length of travel
- R** = Bending radius
- H** = Nominal clearance height
- H<sub>F</sub>** = Required clearance height
- H<sub>tr</sub>** = Trough inner height
- D** = Overlength E-Chain® radius in final position
- K** =  $\pi \cdot R$  + "safety"
- D<sub>2</sub>** = Over length for long travels gliding
- K<sub>2</sub>** = Further add-on if the mounting bracket location is set lower

**Other installation methods**

- Vertical, hanging ≤ 60 m
- Vertical, standing ≤ 4 m
- Side mounted, unsupported = possible to a limited extent
- Unsupported length of upper run = upon request



**Short travels - unsupported**

Unsupported E-Chains® feature positive camber over short travels. This must be accounted for when specifying the clearance height  $H_F$ . Please consult igus® if space is particularly restricted.

The required clearance height:  
 **$H_F = H + 100$  mm**  
 (with 5,0 kg/m fill weight)



System E6  
 Inner height: 80 mm

Phone +49- (0) 22 03-96 49-800  
 Fax +49- (0) 22 03-96 49-222



► page 8.39

Speed / acceleration $FL_G$	max. 20 [m/s] / max. 200 [m/s <sup>2</sup> ]
Speed / acceleration $FL_B$	max. 3 [m/s] / max. 6 [m/s <sup>2</sup> ]
Gliding speed / acceleration (maximum)	upon request
Material - permitted temperature °C	-40° up to +100° C
Flammability class	VDE 0304 IIC UL94 HB

**Technical Data**

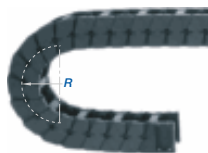
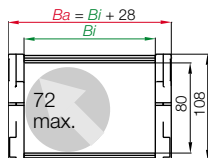

Details of material properties  
 ► page 1.38

Series E6.80L - with crossbars every 2<sup>nd</sup> link

Part No.	Bi [mm]	Ba [mm]	Bending radii	Weight [kg/m]
E6.80L.11.	112	140	175	≈ 3,38
E6.80L.12.	125	153	175	≈ 3,43
E6.80L.13.	137	165	175	≈ 3,49
E6.80L.15.	150	178	175	≈ 3,55
E6.80L.16.	162	190	175	≈ 3,61
E6.80L.17.	175	203	175	≈ 3,67
E6.80L.18.	187	215	175	≈ 3,73
E6.80L.20.	200	228	175	≈ 3,79
E6.80L.21.	212	240	175	≈ 3,85
E6.80L.22.	225	253	175	≈ 3,91
E6.80L.23.	237	265	175	≈ 3,97
E6.80L.25.	250	278	175	≈ 4,02
E6.80L.26.	262	290	175	≈ 4,09
E6.80L.27.	275	303	175	≈ 4,14
E6.80L.28.	287	315	175	≈ 4,20
E6.80L.30.	300	328	175	≈ 4,26
E6.80L.31.	312	340	175	≈ 4,32
E6.80L.32.	325	353	175	≈ 4,38
E6.80L.33.	337	365	175	≈ 4,44
E6.80L.35.	350	378	175	≈ 4,50
E6.80L.36.	362	390	175	≈ 4,56
E6.80L.37.	375	403	175	≈ 4,62
E6.80L.38.	387	415	175	≈ 4,68
E6.80L.40.	400	428	175	≈ 4,74
E6.80L.41.	412	440	175	≈ 4,80
E6.80L.42.	425	453	175	≈ 4,85
E6.80L.43.	437	465	175	≈ 4,92
E6.80L.45.	450	478	175	≈ 5,03
E6.80L.46.	462	490	175	≈ 5,09
E6.80L.47.	475	503	175	≈ 5,15
E6.80L.48.	487	515	175	≈ 5,21
E6.80L.50.	500	528	175	≈ 5,27
E6.80L.51.	512	540	175	≈ 5,33
E6.80L.52.	525	553	175	≈ 5,39
E6.80L.53.	537	565	175	≈ 5,45
E6.80L.55.	550	578	175	≈ 5,51

Supplement Part No. with required radius. Example: E6.80L.15.175.0

0 = standard color, other colors ► page 1.39 · Pitch = 65 mm/link - Links/m = 16

Part No. structure

E6.80L. 15. 175.0



## Part No. E-Chain® - links, single parts

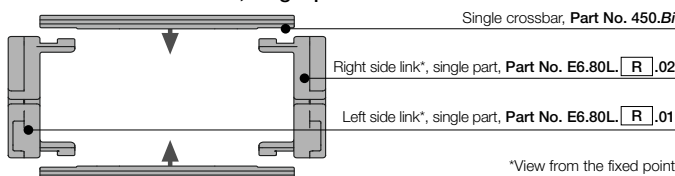

\*View from the fixed point

### Option 1: Vertical separators and spacers

Vertical Separators are used if a vertical subdivision of the E-Chain® interior is required -

By standard vertical separators are assembled every other E-Chain® link

- **Standard separator 511** offers safe stability due to its wide base design, even when used with large diameter cables or hoses

Also available:

- **Locking separator 514** with increased retention force for extreme applications
- The **locking separator 518** is used in applications with very high relative humidity, such as composting plants. The lateral cam serves to ensure the uniform alignment of the vertical separator (in the case of uneven alignment, the E-Chain® can only be opened by breaking the vertical separator)
- If a broad distance shall be kept between the separators or they have to be fixed in their position, e.g. in case of side mounted applications, **spacers 415.10, 415.15, 415.20, 415.30 and 415.40** can be used. Here a great number of possible distances between the vertical separators can be achieved by combining spacers of different widths with the **vertical separator, asymmetrical 511A**

**Instruction:** The available interior height is reduced by 2 mm per spacer, and can hence amount to 4 mm when spacers are fitted on both sides. To avoid this, the parts can also be installed from the outside on the opening crossbar. (no long travels)

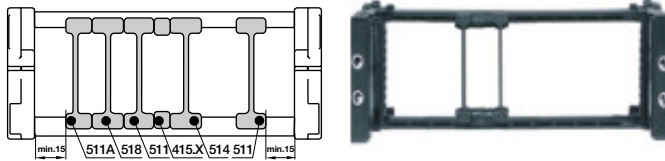

<b>Vertical separator</b>	
unassembled	501
assembled	511

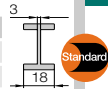

<b>Locking separator</b>	
unassembled	504
assembled	514



<b>Locking separator</b>	
unassembled	508
assembled	518



<b>Ver. separator, asymmetrical</b>	
unassembled	501A
assembled	511A



<b>Spacer*</b>	
unassembled	405.10
assembled	415.10
unassembled	405.15
assembled	415.15
unassembled	405.20
assembled	415.20
unassembled	405.30
assembled	415.30
unassembled	405.40
assembled	405.40

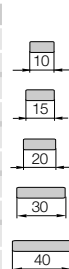

\* for side-mounted applications

<b>Locking vert. separator</b>	
unassembled	510
assembled	520



<b>Locking separator slotted</b>	
unassembled	507
assembled	517



<b>Middle plate</b>	
unassembled	503
assembled	513



<b>Slotted separator</b>	
unassembled	505
assembled	515



<b>Slotted separator, open</b>	
unassembled	509
assembled	519



<b>Side plate** left/right</b>	
unassembled	E6.80.03
assembled	E6.80.13
unassembled	E6.80.04
assembled	E6.80.14

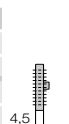

<b>Shelf</b>	

### Option 2: Shelves

For applications involving many cables with similar or identical diameters. Shelves of various widths can be arranged at 11 different heights (in 7 mm increments)

- **Shelf 421.X** can be combined with **Locking vertical separator 521**, **Locking separator, slotted 517**, **middle plate 1313**, **slotted separator 515** and **slotted separator, open 519**
- **Slotted separators 515** are used for complex subdivisions. When **slotted separators, open 519** and **Locking vertical separator 521** are installed only the middle slot can be used for shelves.

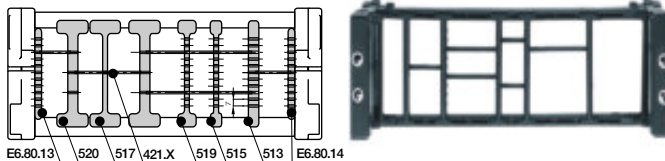

Width X [mm]	Part No. unassembled	Part No. assembled
18	420.18	421.18
23	420.23	421.23
25	420.25	421.25
28	420.28	421.28
33	420.33	421.33
43	420.43	421.43
50	420.50	421.50
62	420.62	421.62

Width X [mm]	Part No. unassembled	Part No. assembled
75	420.75	421.75
100	420.100	421.100
125	420.125	421.125
150	420.150	421.150
175	420.175	421.175
187	420.187	421.187
200	420.200	421.200

System E6  
Inner height: 80 mm

Phone +49- (0) 22 03-96 49-800  
Fax +49- (0) 22 03-96 49-222

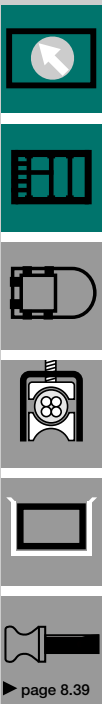

▶ page 8.39



\* KMA = Polymer Metal Mounting Bracket

Moving end  
E6.80L...2

### Option KMA\* - pivoting

- Option - integrated C-profile strain relief device with Chainfix clip or strain relief tiwrap plates
- C-profile mountable in the inner or outer radius of the E-Chain®
- Bolted connection outside of chain cross-section
- Recommended for unsupported applications
- Confined installation conditions
- Universal mountable with attachment capability on all sides

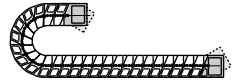

The attachment variants arising automatically by the choice of the KMA mounting bracket

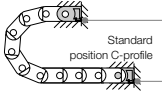

E6.80L...1  
Fixed end

## Dimensions and order configurations

E6.80L...2

Fixed end

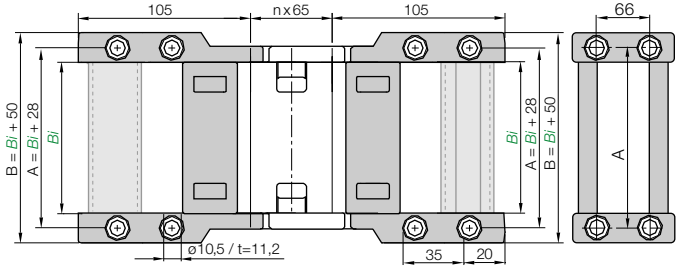

E6.80L...1

Moving end

Phone +49- (0) 22 03-96 49-800  
Fax +49- (0) 22 03-96 49-222

igus® GmbH  
51147 Cologne

Part No. structure

E6.80L 11. 12.C

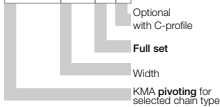

Full set, for both ends:

**E6.80L. 11. 12.C** (with C-profile)

Single-part order:

**E6.80L. 11. 1.C** (with C-profile)

Fixed end mounting bracket

**E6.80L. 11. 2.C** (with C-profile)

Moving end mounting bracket

For	Part No. full set	$B_i$
E-Chain®	optional with C-profile	[mm]
E6.80L.11	E6.800L.11.12.C	112
E6.80L.12	E6.800L.12.12.C	125
E6.80L.13	E6.800L.13.12.C	137
E6.80L.15	E6.800L.15.12.C	150
E6.80L.16	E6.800L.16.12.C	162
E6.80L.17	E6.800L.17.12.C	175
E6.80L.18	E6.800L.18.12.C	187
E6.80L.20	E6.800L.20.12.C	200
E6.80L.21	E6.800L.21.12.C	212
E6.80L.22	E6.800L.22.12.C	225
E6.80L.23	E6.800L.23.12.C	237
E6.80L.25	E6.800L.25.12.C	250
E6.80L.26	E6.800L.26.12.C	262
E6.80L.27	E6.800L.27.12.C	275
E6.80L.28	E6.800L.28.12.C	287
E6.80L.30	E6.800L.30.12.C	300
E6.80L.31	E6.800L.31.12.C	312
E6.80L.32	E6.800L.32.12.C	325

For	Part No. full set	$B_i$
E-Chain®	optional with C-profile	[mm]
E6.80L.33	E6.800L.33.12.C	337
E6.80L.35	E6.800L.35.12.C	350
E6.80L.36	E6.800L.36.12.C	362
E6.80L.37	E6.800L.37.12.C	375
E6.80L.38	E6.800L.38.12.C	387
E6.80L.40	E6.800L.40.12.C	400
E6.80L.42	E6.800L.42.12.C	425
E6.80L.43	E6.800L.43.12.C	437
E6.80L.45	E6.800L.45.12.C	450
E6.80L.46	E6.800L.46.12.C	462
E6.80L.47	E6.800L.47.12.C	475
E6.80L.48	E6.800L.48.12.C	487
E6.80L.50	E6.800L.50.12.C	500
E6.80L.51	E6.800L.51.12.C	512
E6.80L.52	E6.800L.52.12.C	525
E6.80L.53	E6.800L.53.12.C	537
E6.80L.55	E6.800L.55.12.C	550

Internet: [www.igus.de](http://www.igus.de)  
E-mail: [info@igus.de](mailto:info@igus.de)



Other strain relief elements - optional ▶ chapter 10



## Series E6.80L | Accessories | Strain Relief

Strain relief tiwrap plate can be fixed on the last crossbar, alternatively with C-profile. Tiwrap plate as individual part - Part No. 30XX.ZB. Further strain relief elements ▶ chapter 10

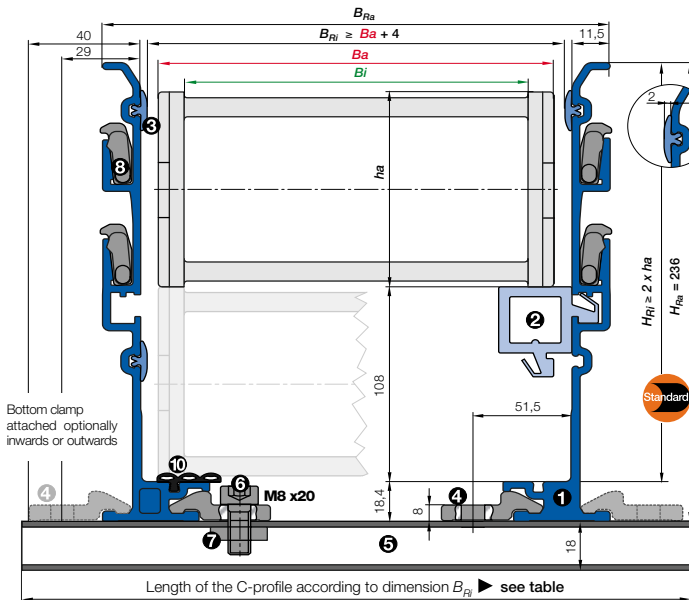

- $B_a$  = Outer width E-Chains\* / E-Tube
  - $B_i$  = Inner width E-Chains\* / E-Tube
  - $h_a$  = Outer height E-Chains\* / E-Tube
  - $H_{Ri}$  = Inner trough height
  - $H_{Ra}$  = Outer trough height
  - $B_{Ri}$  = Inner trough width ► depends on dim.  $B_a$
  - $B_{Ra}$  = Outer trough width
  - $n_{Mon}$  = Number of installation sets (left/right)
  - $n_{Ri}$  = Number of trough sets (left/right)
  - $H_{Ri} \geq 2 \cdot h_a$
  - $B_{Ri} \geq B_a + 4$
- = Guide trough set
  - = Glide bar
  - = Installation set "Basic"
  - = C-profile

**Installation set "Basic" with C-profile**

Bottom Clamp attached optionally inwards or outwards

E6.80L.30.300.0 ► Order example

$B_{Ri}$ [mm]	Part No. attached inwards	Part No. attached outwards
.11	144 960.50.200	960.50.275
.12	157 960.50.225	960.50.275
.13	169 960.50.225	960.50.300
.15	182 960.50.250	960.50.300
.16	194 960.50.250	960.50.325
.17	207 960.50.275	960.50.325
.18	219 960.50.275	960.50.350
.20	232 960.50.300	960.50.350
.21	244 960.50.300	960.50.375
.22	257 960.50.325	960.50.375
.23	269 960.50.325	960.50.400
.25	282 960.50.350	960.50.400
.26	294 960.50.350	960.50.425
.27	307 960.50.375	960.50.425
.28	319 960.50.375	960.50.450
.30	332 960.50.400	960.50.450
.31	344 960.50.400	960.50.475
.32	357 960.50.425	960.50.475
.33	369 960.50.425	960.50.500
.35	382 960.50.450	960.50.500
.36	394 960.50.450	960.50.525
.37	407 960.50.475	960.50.525
.38	419 960.50.475	960.50.550
.40	432 960.50.500	960.50.550
.41	444 960.50.500	960.50.575
.42	457 960.50.525	960.50.575
.43	469 960.50.525	960.50.600
.45	482 960.50.550	960.50.600
.46	494 960.50.550	960.50.625
.47	507 960.50.575	960.50.625
.48	519 960.50.575	960.50.650
.50	532 960.50.600	960.50.650
.51	544 960.50.600	960.50.675
.52	557 960.50.625	960.50.675
.53	569 960.50.625	960.50.700
.55	582 960.50.650	960.50.700

- **Components, trough "Basic":** ① Trough side parts, aluminum, 2 m ② Glide bar, plastic, 2 m ③ Glide strips, plastic, 2 m (without glide strips on request) ⑩ Optional: Silencer profile, rubber
- **Components, installation set "Basic":** ④ Bottom clamp, aluminum ⑤ C-profile, steel galvanized ⑥ Screw M8 x20 ⑦ Sliding nut M8 ⑧ Interface connector, plastic

**Order example: Length of travel 30 m - Center mounted for Series E6.80L.30.300.0 with  $B_{Ri} = 332$**

- Guide trough set (set of 2 trough side parts, incl. glide strips) **without** glide bar  
**Order text: 16 m guide trough without glide bar (8 x 2 m sections)** Part No. **975.30.SL**
- Guide trough set (set of 2 trough side parts, incl. glide strips) **with** glide bar  
**Order text: 16 m guide trough with glide bar (8 x 2 m sections)** Part No. **975.31.SL**
- Installation set "Basic" complete (guide trough-sets + 1)  
**Order text: 17 installation sets "Basic"** Part No. **960.50.425**
- Module for the fixed end  
**Order text: 1 set** Part No. **975.80**
- Option:** For an additional noise dampening with silencer profile, please add Index A - Example: Part No. **975.30.SLA**

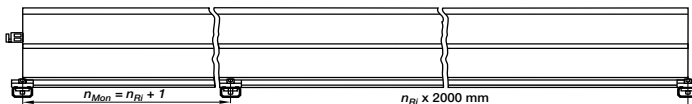

Principle sketch: Number of installation sets to be installed = Number of trough sections + 1

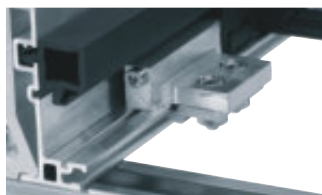

**NEW! A quick fix for mounting the stationary end of an E-Chain®**

With this new module for the fixed end, fast and easy mounting onto the Aluminum "SuperTrough" is now possible without any drilling. Fast mounting of the E-Chain® by clamping onto the aluminum trough

- Quick relocation of the stationary end
- No drilling necessary ► page 9.16

Insert for the installation set "Heavy-Duty": **974.50.XXX** instead of (**960.50.XXX**) on the right column "attached outwards"





Price index



Extremely low noise  
Test results upon request



Cleanroom test  
upon request



ATEX-ESD Standard Material: igumid G  
- ESD compatibility Level 1 according  
to SEMI E78-0998 ESD igumid ESD  
special material (upon request): Superior  
long-term conductivity due to lack of  
pin and bore tolerances (no air gaps)



To close, push and click shut



#### When to use the Series E6.80:

- If a low-noise version is required
- At very high speeds and/or accelerations
- For enlarged thrusts and tensile forces
- For small bending radii
- If less vibration is required
- Minimal abrasion  
(e.g. cleanroom applications)



#### When not to use it:

- Limited in side-mounted applications
  - ▶ Series 5050 System E4, page 7.136
- No use with RBR (reverse bending radius)
  - ▶ Series 5050 System E4, page 7.136
- No use with high additional loads
  - ▶ Series 5050 System E4, page 7.136

- ❶ No pin and bore connection
- ❷ Interior stop dog
- ❸ Small pitch for low-noise, smooth operation
- ❹ Increased inner height
- ❺ Very large gliding surfaces
- ❻ KMA-Mounting Brackets with attachment points on all sides
- ❼ Can be shortened or lengthened due to modular design
- ❽ Optional with or without integrated C-profile

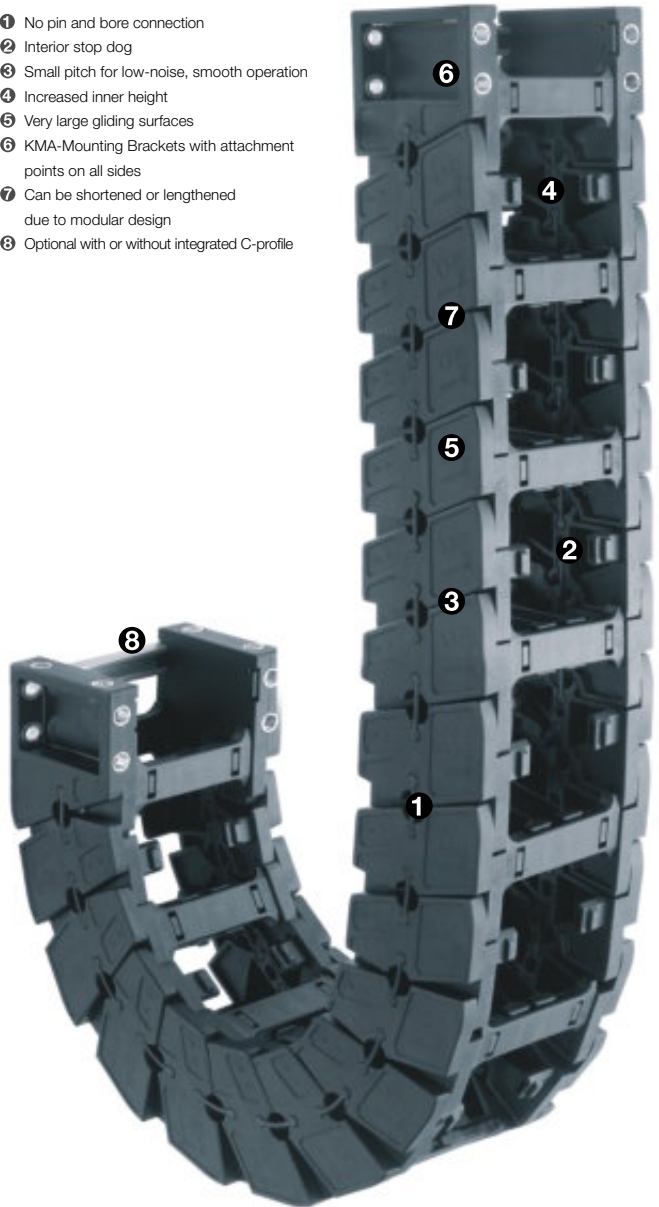

#### Order example complete E-Chain®

Please indicate chain-lengths or number of links **Example: 5 m or 80 links**

5 m **E6.80.10.200.0**

E-Chain®

with 2 separators **511** assembled every 2<sup>nd</sup> link

Interior separation

1 set **E6.800.10.12**

Mounting bracket

**Unsupported length**

$FL_G$  = with straight upper run

$FL_B$  = with permitted sag

Further information ► **Design, page 1.12**

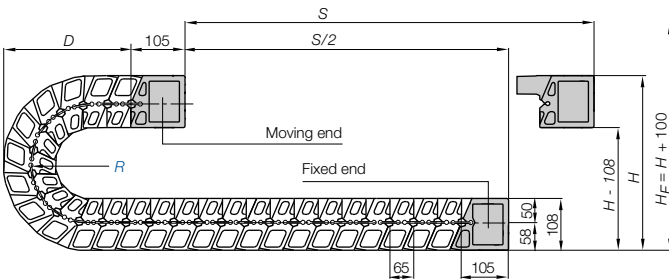
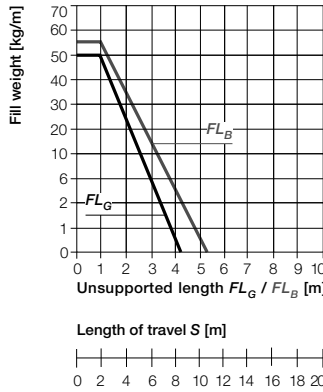
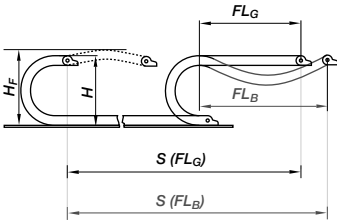

**Pitch = 65 mm/link Links/m = 16 (1040 mm) Chain length =  $S/2 + K$**

R	150	200	250	300	350	400	450
H	416	516	616	716	816	916	1016
D	273	323	373	423	473	523	573
K	605	760	920	1075	1230	1390	1545
$D_2^{+25}$	524	936	1349	1762	2175	2588	3000
$K_2$	650	1170	1690	2275	2795	3315	3835

- S = Length of travel
- R = Bending radius
- H = Nominal clearance height
- $H_F$  = Required clearance height
- $H_{H1}$  = Trough inner height
- D = Overlength E-Chain® radius in final position
- K =  $\pi \cdot R$  + "safety"
- $D_2$  = Over length for long travels gliding
- $K_2$  = Further add-on if the mounting bracket location is set lower

**Other installation methods**

- Vertical, hanging  $\leq 60$  m
- Vertical, standing  $\leq 4$  m
- Side mounted, unsupported = possible to a limited extent
- Unsupported length of upper run = upon request



**Short travels - unsupported**

Unsupported E-Chains® feature positive camber over short travels. This must be accounted for when specifying the clearance height  $H_F$ . Please consult igus® if space is particularly restricted.

The required clearance height:  
 $H_F = H + 100$  mm  
 (with 5,0 kg/m fill weight)

**Long travel lengths from 10 m to max. 120 m Chain length =  $S/2 + K_2$**

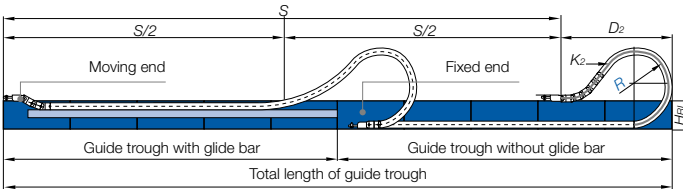

In case of travels between 4 m and 12 m we recommend a longer unsupported length.



**Gliding, long travel applications (max. 120 m)**

In this case the E-Chain® upper run will be introduced in a guide trough on the lower run. We recommend to realize the engineering of such a plant by our technicians.

Speed / acceleration $FL_G$	max. 20 [m/s] / max. 200 [m/s <sup>2</sup> ]
Speed / acceleration $FL_B$	max. 3 [m/s] / max. 6 [m/s <sup>2</sup> ]
Gliding speed / acceleration (maximum)	upon request
permitted temperature °C	-40° up to +100° C
Flammability class	VDE 0304 IIC UL94 HB

**Technical Data**



Details of material properties  
 ► page 1.38

80

System E6  
 Inner height: 80 mm

Phone +49- (0) 22 03-96 49-800  
 Fax +49- (0) 22 03-96 49-222



► page 8.39



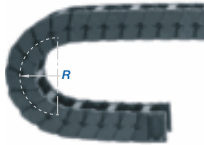
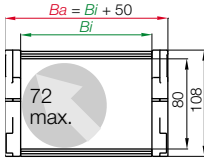

Series E6.80 - with crossbars every 2<sup>nd</sup> link

Part No.	Bl [mm]	Ba [mm]	R [mm]	Bending radii							Weight [kg/m]
E6.80.05.	50	100	150	200	250	300	350	400	450	≈ 5,21	
E6.80.06.	65	115	150	200	250	300	350	400	450	≈ 5,28	
E6.80.07.	75	125	150	200	250	300	350	400	450	≈ 5,33	
E6.80.10.	100	150	150	200	250	300	350	400	450	≈ 5,45	
E6.80.11.	112	162	150	200	250	300	350	400	450	≈ 5,50	
E6.80.12.	125	175	150	200	250	300	350	400	450	≈ 5,57	
E6.80.13.	137	187	150	200	250	300	350	400	450	≈ 5,62	
E6.80.15.	150	200	150	200	250	300	350	400	450	≈ 5,68	
E6.80.16.	162	212	150	200	250	300	350	400	450	≈ 5,74	
E6.80.17.	175	225	150	200	250	300	350	400	450	≈ 5,80	
E6.80.18.	187	237	150	200	250	300	350	400	450	≈ 5,86	
E6.80.20.	200	250	150	200	250	300	350	400	450	≈ 5,92	
E6.80.21.	212	262	150	200	250	300	350	400	450	≈ 5,98	
E6.80.22.	225	275	150	200	250	300	350	400	450	≈ 6,04	
E6.80.23.	237	287	150	200	250	300	350	400	450	≈ 6,10	
E6.80.25.	250	300	150	200	250	300	350	400	450	≈ 6,16	
E6.80.26.	262	312	150	200	250	300	350	400	450	≈ 6,21	
E6.80.27.	275	325	150	200	250	300	350	400	450	≈ 6,28	
E6.80.28.	287	337	150	200	250	300	350	400	450	≈ 6,33	
E6.80.30.	300	350	150	200	250	300	350	400	450	≈ 6,39	
E6.80.31.	312	362	150	200	250	300	350	400	450	≈ 6,45	
E6.80.32.	325	375	150	200	250	300	350	400	450	≈ 6,51	
E6.80.33.	337	387	150	200	250	300	350	400	450	≈ 6,57	
E6.80.35.	350	400	150	200	250	300	350	400	450	≈ 6,63	
E6.80.36.	362	412	150	200	250	300	350	400	450	≈ 6,69	
E6.80.37.	375	425	150	200	250	300	350	400	450	≈ 6,75	
E6.80.38.	387	437	150	200	250	300	350	400	450	≈ 6,80	
E6.80.40.	400	450	150	200	250	300	350	400	450	≈ 6,88	
E6.80.41.	412	462	150	200	250	300	350	400	450	≈ 6,92	
E6.80.42.	425	475	150	200	250	300	350	400	450	≈ 6,99	
E6.80.43.	437	487	150	200	250	300	350	400	450	≈ 7,04	
E6.80.45.	450	500	150	200	250	300	350	400	450	≈ 7,10	
E6.80.46.	462	512	150	200	250	300	350	400	450	≈ 7,16	
E6.80.47.	475	525	150	200	250	300	350	400	450	≈ 7,22	
E6.80.48.	487	537	150	200	250	300	350	400	450	≈ 7,28	
E6.80.50.	500	550	150	200	250	300	350	400	450	≈ 7,34	
E6.80.51.	512	562	150	200	250	300	350	400	450	≈ 7,40	
E6.80.52.	525	575	150	200	250	300	350	400	450	≈ 7,46	
E6.80.53.	537	587	150	200	250	300	350	400	450	≈ 7,52	
E6.80.55.	550	600	150	200	250	300	350	400	450	≈ 7,58	
E6.80.60.	600	650	150	200	250	300	350	400	450	≈ 7,81	

Part No. structure

E6.80.10.200.0



Supplement Part No. with required radius. Example: E6.80.10.200.0

0 = standard color, other colors ▶ page 1.39 · Pitch = 65 mm/link - Links/m = 16



Part No. E-Chain® - links, single parts

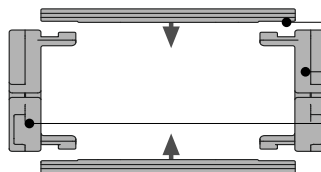

Single crossbar, Part No. 450.BI

Right side link\*, single part, Part No. E6.80. [R] .02

Left side link\*, single part, Part No. E6.80. [R] .01

\*View from the fixed point

### Option 1: Vertical separators and spacers

Vertical separators are used if a vertical subdivision of the E-Chain® interior is required -

By standard vertical separators are assembled every other E-Chain® link

- **Standard separator 511** offers safe stability due to its wide base design, even when used with large diameter cables or hoses

Also available:

- **Locking separator 514** with increased retention force for extreme applications
- The **locking separator 518** is used in applications with very high relative humidity, such as composting plants. The lateral cam serves to ensure the uniform alignment of the vertical separator (in the case of uneven alignment, the E-Chain® can only be opened by breaking the vertical separator)
- If a broad distance shall be kept between the separators or they have to be fixed in their position, e.g. in case of side mounted applications, **Spacers 415.10, 415.15, 415.20, 415.30 and 415.40** can be used. Here a great number of possible distances between the vertical separators can be achieved by combining spacers of different widths with the **vertical separator, asymmetrical 511A**

**Instruction:** The available interior height is reduced by 2 mm per spacer, and can hence amount to 4 mm when spacers are fitted on both sides. To avoid this, the parts can also be installed from the outside on the opening crossbar. (no long travels)

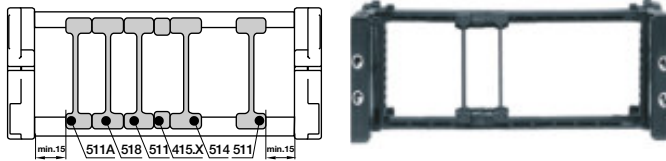

### Option 2: Shelves

For applications involving many cables with similar or identical diameters. Shelves of various widths can be arranged at 11 different heights (in 7 mm increments)

- **Shelf 421.X** can be combined with **Locking vertical separator 521**, **Locking separator, slotted 517**, **middle plate 1313**, **slotted separator 515** and **slotted separator, open 519**
- **Slotted separators 515** are used for complex subdivisions. When **slotted separators, open 519** and **Locking vertical separator 521** are installed only the middle slot can be used for shelves

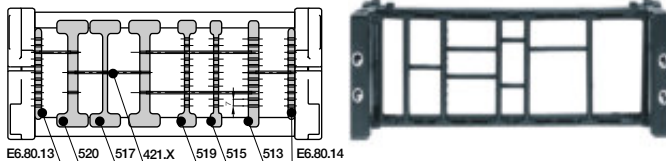

Width X [mm]	Part No. unassembled	Part No. assembled
18	420.18	421.18
23	420.23	421.23
25	420.25	421.25
28	420.28	421.28
33	420.33	421.33
43	420.43	421.43
50	420.50	421.50
62	420.62	421.62

Width X [mm]	Part No. unassembled	Part No. assembled
75	420.75	421.75
100	420.100	421.100
125	420.125	421.125
150	420.150	421.150
175	420.175	421.175
187	420.187	421.187
200	420.200	421.200

Vertical separator	
unassembled	501
assembled	511



Locking separator	
unassembled	504
assembled	514



Locking separator	
unassembled	508
assembled	518



Ver. separator, asymmetrical	
unassembled	501A
assembled	511A



Spacer*	
unassembled	405.10
assembled	415.10
unassembled	405.15
assembled	415.15
unassembled	405.20
assembled	415.20
unassembled	405.30
assembled	415.30
unassembled	405.40
assembled	405.40

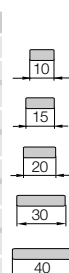

Locking vert. separator	
unassembled	510
assembled	520



Locking separator, slotted	
unassembled	507
assembled	517



Middle plate	
unassembled	503
assembled	513



Slotted separator	
unassembled	505
assembled	515



Slotted separator, open	
unassembled	509
assembled	519



Side plate** left/right	
unassembled	E6.80.03
assembled	E6.80.13
unassembled	E6.80.04
assembled	E6.80.14

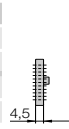

Shelf	
X = 8	
t = 4,5	



System E6  
Inner height: 80 mm

Phone +49- (0) 22 03-96 49-800  
Fax +49- (0) 22 03-96 49-222

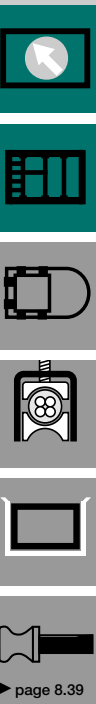

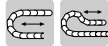

\* KMA = Polymer Metal Mounting Bracket

**Option KMA\* - pivoting**

- Option - integrated C-profile strain relief device with Chainfix clip or strain relief tiwrap plates
- C-profile mountable in the inner or outer radius of the E-Chain®
- Bolted connection outside of chain cross-section
- Recommended for unsupported and gliding applications
- Confined installation conditions
- Universal mountable with attachment capability on all sides

Moving end  
E6.800...2

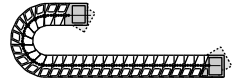

The attachment variants arising automatically by the choice of the KMA mounting bracket

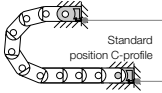

E6.800...1  
Fixed end

**Dimensions and order configurations**



Adapters for gliding applications available upon request

E6.800...2  
Fixed end

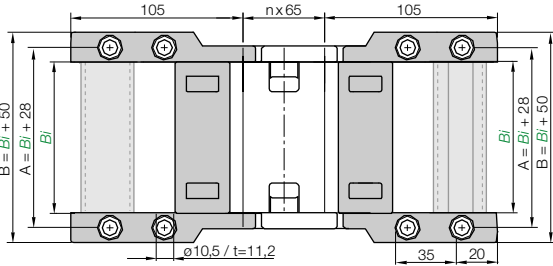

E6.800...1  
Moving end

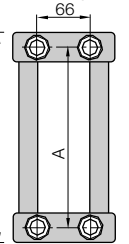

Phone +49- (0) 22 03-96 49-800  
Fax +49- (0) 22 03-96 49-222

igus® GmbH  
51147 Cologne

Part No. structure

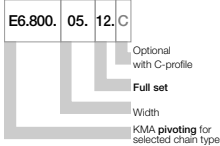

Full set, for both ends:

**E6.800.05.12.C** (with C-profile)

Single-part order:

**E6.800.05.1.C** (with C-profile)

Fixed end mounting bracket

**E6.800.05.2.C** (with C-profile)

Moving end mounting bracket

For	Part No. full set	Bi
E-Chain®	optional with C-profile	[mm]
E6.80.05.	E6.800.05.12.C	50
E6.80.06.	E6.800.06.12.C	65
E6.80.07.	E6.800.07.12.C	75
E6.80.10.	E6.800.10.12.C	100
E6.80.11.	E6.800.11.12.C	112
E6.80.12.	E6.800.12.12.C	125
E6.80.13.	E6.800.13.12.C	137
E6.80.15.	E6.800.15.12.C	150
E6.80.16.	E6.800.16.12.C	162
E6.80.17.	E6.800.17.12.C	175
E6.80.18.	E6.800.18.12.C	187
E6.80.20.	E6.800.20.12.C	200
E6.80.21.	E6.800.21.12.C	212
E6.80.22.	E6.800.22.12.C	225
E6.80.23.	E6.800.23.12.C	237
E6.80.25.	E6.800.25.12.C	250
E6.80.26.	E6.800.26.12.C	262
E6.80.27.	E6.800.27.12.C	275
E6.80.28.	E6.800.28.12.C	287
E6.80.30.	E6.800.30.12.C	300
E6.80.31.	E6.800.31.12.C	312

For	Part No. full set	Bi
E-Chain®	optional with C-profile	[mm]
E6.80.32.	E6.800.32.12.C	325
E6.80.33.	E6.800.33.12.C	337
E6.80.35.	E6.800.35.12.C	350
E6.80.36.	E6.800.36.12.C	362
E6.80.37.	E6.800.37.12.C	375
E6.80.38.	E6.800.38.12.C	387
E6.80.40.	E6.800.40.12.C	400
E6.80.41.	E6.800.41.12.C	412
E6.80.42.	E6.800.42.12.C	425
E6.80.43.	E6.800.43.12.C	437
E6.80.45.	E6.800.45.12.C	450
E6.80.46.	E6.800.46.12.C	462
E6.80.47.	E6.800.47.12.C	475
E6.80.48.	E6.800.48.12.C	487
E6.80.50.	E6.800.50.12.C	500
E6.80.51.	E6.800.51.12.C	512
E6.80.52.	E6.800.52.12.C	525
E6.80.53.	E6.800.53.12.C	537
E6.80.55.	E6.800.55.12.C	550
E6.80.60.	E6.800.60.12.C	600

Internet: [www.igus.de](http://www.igus.de)  
E-mail: [info@igus.de](mailto:info@igus.de)

**Series E6.80 | Accessories | Strain Relief**



Other strain relief elements - optional ▶ chapter 10

Strain relief tiwrap plate can be fixed on the last crossbar, alternatively with C-profile. Tiwrap plate as individual part - Part No. 30XX.ZB. Further strain relief elements ▶ chapter 10



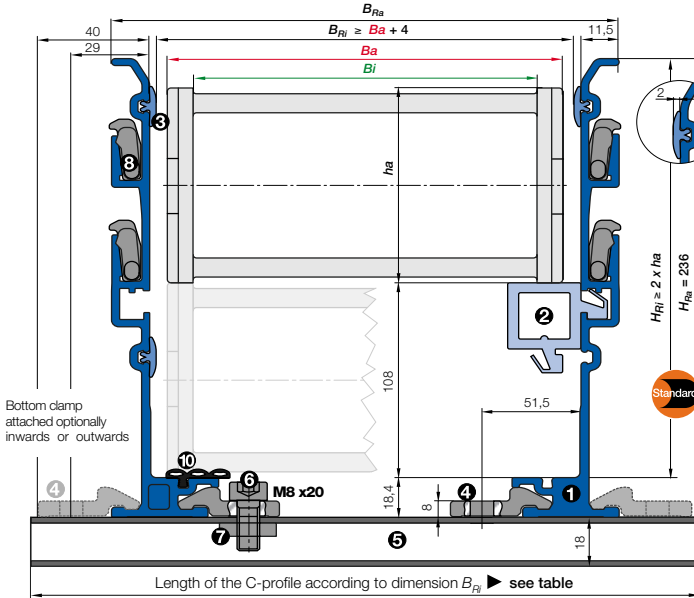

- $B_a$  = Outer width E-Chains / E-Tube
  - $B_i$  = Inner width E-Chains / E-Tube
  - $ha$  = Outer height E-Chains / E-Tube
  - $H_{Ri}$  = Inner trough height
  - $H_{Ra}$  = Outer trough height
  - $B_{Ri}$  = Inner trough width ▶ depends on dim.  $B_a$
  - $B_{Ra}$  = Outer trough width
  - $n_{Mon}$  = Number of installation sets (left/right)
  - $n_{Ri}$  = Number of trough sets (left/right)
  - $H_{Ri} \geq 2 \cdot ha$
  - $B_{Ri} \geq B_a + 4$
- = Guide trough set
  - = Glide bar
  - = Installation set "Basic"
  - = C-profile

### Installation set "Basic" with C-profile

Bottom Clamp attached optionally inwards or outwards

E6.80.30.300.0 ▶ Order example

$B_{Ri}$ [mm]	Part No.	
	attached inwards	attached outwards
.05	104	960.50.225
.06	119	960.50.250
.07	129	960.50.250
.10	154	960.50.225
.11	167	960.50.225
.12	179	960.50.250
.13	192	960.50.250
.15	204	960.50.275
.16	217	960.50.275
.17	229	960.50.300
.18	242	960.50.300
.20	254	960.50.325
.21	267	960.50.325
.22	279	960.50.350
.23	292	960.50.350
.25	304	960.50.375
.26	317	960.50.375
.27	329	960.50.400
.28	342	960.50.400
.30	354	960.50.425
.31	367	960.50.425
.32	379	960.50.450
.33	392	960.50.450
.35	404	960.50.475
.36	417	960.50.475
.37	429	960.50.500
.38	442	960.50.500
.40	454	960.50.525
.41	467	960.50.525
.42	479	960.50.550
.43	492	960.50.550
.45	504	960.50.575
.46	517	960.50.575
.47	529	960.50.600
.48	542	960.50.600
.50	554	960.50.625
.51	567	960.50.625
.52	579	960.50.650
.53	592	960.50.650
.55	604	960.50.675
.60	654	960.50.725

- **Components, trough "Basic":** ① Trough side parts, aluminum, 2 m ② Glide bar, plastic, 2 m ③ Glide strips, plastic, 2 m (without glide strips on request) ⑩ Optional: Silencer profile, rubber
- **Components, installation set "Basic":** ④ Bottom clamp, aluminum ⑤ C-profile, steel galvanized ⑥ Screw M8 x20 ⑦ Sliding nut M8 ⑧ Interface connector, plastic



**Order example: Length of travel 30 m - Center mounted for Series E6.80.30.300.0 with  $B_{Ri} = 354$**

Guide trough set (set of 2 trough side parts, incl. glide strips) <b>without</b> glide bar	
<b>Order text: 16 m guide trough without glide bar (8 x 2 m sections)</b>	<b>Part No. 975.30.SL</b>
Guide trough set (set of 2 trough side parts, incl. glide strips) <b>with</b> glide bar	
<b>Order text: 16 m guide trough with glide bar (8 x 2 m sections)</b>	<b>Part No. 975.31.SL</b>
Installation set "Basic" complete (guide trough-sets + 1)	
<b>Order text: 17 installation sets "Basic"</b>	<b>Part No. 960.50.425</b>
Module for the fixed end	
<b>Order text: 1 set</b>	<b>Part No. 975.80</b>
<b>Option:</b> For an additional noise dampening with silencer profile, please add Index A - Example:	<b>Part No. 975.30.SLA</b>

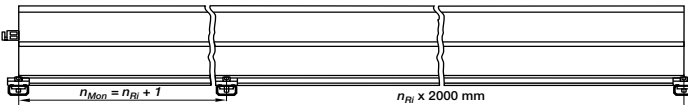

Principle sketch: Number of installation sets to be installed = Number of trough sections + 1

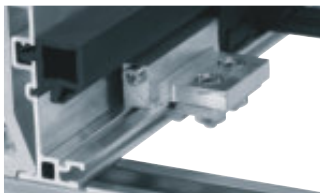

### NEW! A quick fix for mounting the stationary end of an E-Chain®

With this new module for the fixed end, fast and easy mounting onto the Aluminum "SuperTrough" is now possible without any drilling. Fast mounting of the E-Chain® by clamping onto the aluminum trough

- Quick relocation of the stationary end
- No drilling necessary ▶ page 9.16

Insert for the installation set "Heavy-Duty": **974.50.XXX** instead of **(960.50.XXX)** on the right column "attached outwards"





# Solutions for long travel applications... with or without Guide Troughs

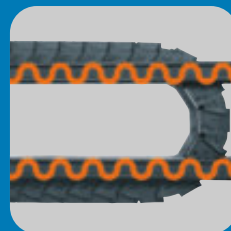
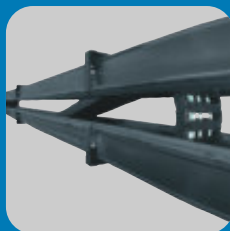
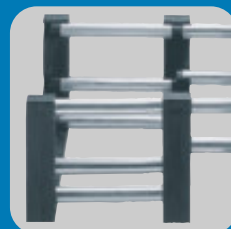

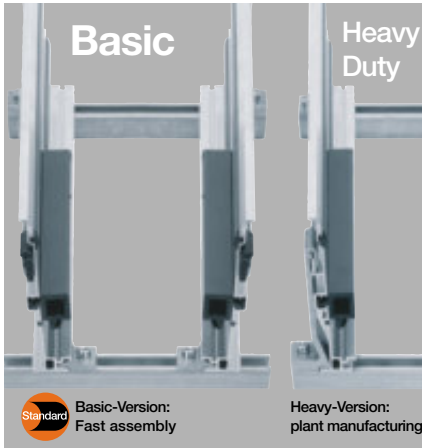

### Aluminium "SuperTrough" - The igus® standard guide trough

- Very simple, modular assembly
- Side-mounted glide strips for wear protection in high-speed
- Corrosion resistant, seawater resistant aluminium profile
- Flexible assembly - Fastening on substructure independent of profile lengths and butt joints
- Interface connector - Plastic with snap-in connection
- Plastic glide bar made of PE
- Bottom clamp can be mounted -inside or outside- directly on the bottom or on the c-profile
- Glide strips and silencer profile for the minimization of the noise level
- Heavy duty brackets for safe connection also for rough applications
- C-profile for the fixation of the bottom clamp or heavy duty brackets

Aluminium "SuperTrough" ► from page 9.12



### Steel guide trough - very stable and rugged for heavy duty applications

- Easy assembly with installation set
- Big range, two piece design, adjustable to E-Chain® width
- Available in galvanized steel and stainless steel
- Glide bar made of PE

Steel guide troughs ► from page 9.42

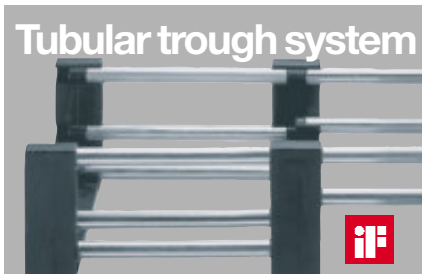

### Tubular trough system RS - lets light and dirt through

- Resistant to dirt - wear debris falls through
- More translucent than sheet metal constructions
- Easy and fast assembly
- Low price
- Easy and space saving delivery
- iF-Design Award

Tubular troughs ► from page 9.64



### Snap-in trough system SP - simple and cost effective

- Smaller than conventional troughs
- Easy and fast assembly
- No sharp metal edges in the internal area because of covered connectors
- Low price because of easy assembly

Snap-in troughs ► from page 9.64



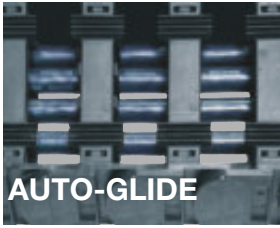

**AUTO-GLIDE**



**AUTO-GLIDE - Long travels without guide troughs**

Travels up to 50 m, speeds up to 1,5 m/s

- AUTO-GLIDE E-Chain® links are moulded and no additional parts are necessary
- Very fast assembly times for long travels - No Guide Troughs required!
- Easy Chain® principle: cables and hoses can be put in without opening the E-Chain®
- Narrow construction width, quiet running
- Function guarantee on the whole system with Chainflex® cables
- 4 versions available

**AUTO-GLIDE** ► from page 9.72



**Rol E-Chain®**



**Rol E-Chain® - Rolling instead of gliding**

Travels up to 800 m, speeds up to 10 m/s

- Major reduction in drive power to less than 25 % for moving the E-Chain®
- Various roller types for optimum application adaption
- Can be used even in dirty environments
- Available as ready-to-fit, made-to-specifications system
- Rol E-Chain® is designed for applications with long travel lengths at high speed
- Low total life cost through reduced wear

**Rol E-Chain®** ► from page 9.78

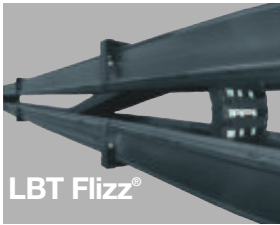

**LBT Flizz®**



**LBT Flizz® - Enclosed plastic trough**

Travels up to 200 m, speeds up to 8 m/s

- Applicable for moving and stationary control, ideal for all bus systems
- Good for applications needing low weight and good corrosion resistance
- Quiet and maintenance free operation
- At -35°C up to +80°C continuous temperature
- Accelerations over 10 m/s<sup>2</sup>
- Energy supply for all media, not only for electrical

**LBT Flizz®** ► from page 9.82

Special solutions | Further igus® solutions for long travels



**Micro Flizz®**



**Micro Flizz® - Small E-Chains® in aluminum profile**

ONE compact system for a secure guidance of power, data and air

- Maintenance-free alternative for busbar
- Control via stationary switch cabinet possible
- Accelerations up to 50 m/s<sup>2</sup> and speeds up to 6 m/s
- Fast assembly due to pre-configured, modular system
- Less space required
- Smooth running due to ball bearings in the guide carriages

**Micro Flizz®** ► from page 9.86



**LeviChain**





**LeviChain - magnetic E-ChainSystem® - it "floats"**

Long travel possible without laying the E-Chain® systems on top of each other

- Almost no abrasion and very low wear due to low-abrasion E-Chain® links (without pin/bore connection) as well as almost contactless movement of the E-Chain®
- Low noise [41.7 dB(A) in 1 m distance], almost no rolling or sliding noise
- High speeds and accelerations are possible
- Simple assembly, even as a retrofit
- Variable installation positions (horizontal and vertical) possible

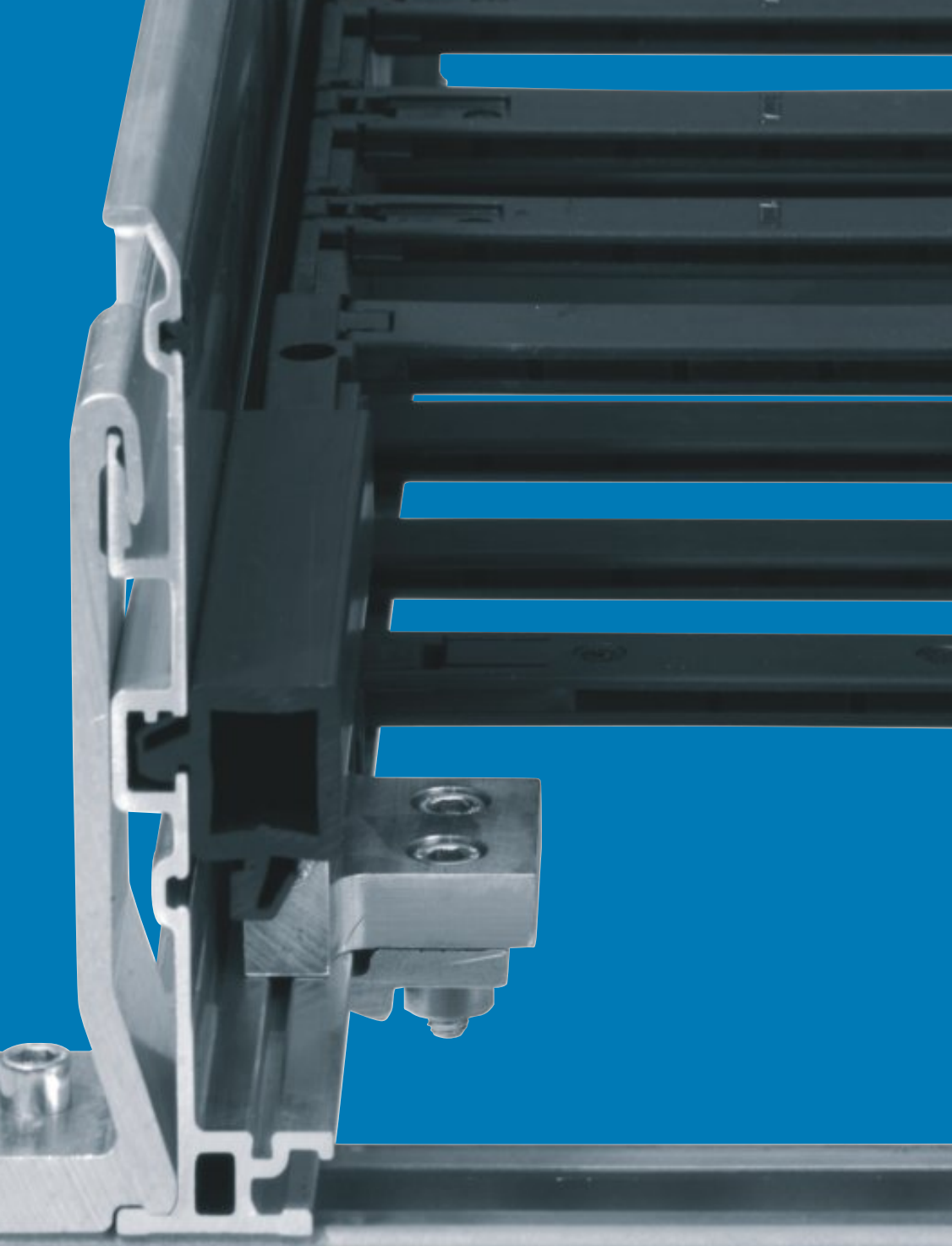
**LeviChain** ► from page 9.92



A detailed cross-sectional view of a Guide Trough System. The image shows a complex assembly of metal components, including a central trough with a curved profile, a mounting bracket with two screws, and a base plate with a circular hole. The components are shown in a dark grey or black color against a solid blue background. The text "Guide Trough Systems" is overlaid in white on the right side of the image.

# Guide Trough Systems

OBO - 1268 -

## Aluminum "SuperTrough" | Basic version - for general machinery

**Basic version**

▶ from page 9.20

Guide trough Series Part No.	Outer trough height $H_{Ra}$ [mm]	Price index	Materials of side parts	Page
970.30.SL / 970.31.SL	77	● ● ●	Aluminum	9.20
970.30.SL / 970.32.SL	77	● ● ●	Aluminum	9.22
971.30.SL / 971.31.SL	87	● ● ●	Aluminum	9.24
972.02.30.SL / 972.02.31.SL	117	● ● ●	Aluminum	9.26
972.30.SL / 972.31.SL	117	● ● ●	Aluminum	9.28
972.30.SL / 972.32.SL	117	● ● ●	Aluminum	9.30
973.30.SL / 973.31.SL	144	● ● ●	Aluminum	9.32
974.30.SL / 974.31.SL	184	● ● ●	Aluminum	9.34
975.30.SL / 975.31.SL	236	● ● ●	Aluminum	9.38

**Assembly kit for the basic version**

The basic assembly kits are the standard for the super aluminum troughs. They can be fastened inside or outside and are recommended for most application areas. The basic clamping shoes are made of aluminum. The part numbers of the basic assembly kits can be found on the corresponding Super-Alu-Trough page.

## Aluminum "SuperTrough" | Heavy-duty version - for rugged plant construction

**Heavy-Duty Version**

▶ fom page 9.24

Guide trough Series Part No.	Outer trough height $H_{Ra}$ [mm]	Price index	Materials of side parts	Page
971.30.SL / 971.31.SL	87	● ● ●	Aluminum	9.24
972.02.30.SL / 972.02.31.SL	117	● ● ●	Aluminum	9.26
972.30.SL / 972.31.SL	117	● ● ●	Aluminum	9.28
972.30.SL / 972.32.SL	117	● ● ●	Aluminum	9.30
973.30.SL / 973.31.SL	144	● ● ●	Aluminum	9.32
974.30.SL / 974.31.SL	184	● ● ●	Aluminum	9.36
975.30.SL / 975.31.SL	236	● ● ●	Aluminum	9.40

**Assembly kit for the heavy-duty version**

The heavy-duty version of the Super-Alu-Trough is differentiated only by the type of the assembly kit. The part numbers of the channel side plates, slide bars, etc., are the same as the basic model. The heavy-duty assembly kit consists of a rugged aluminum bracket, fastened outside on the guide trough. The heavy-duty assembly kits are recommended for plant construction and extreme application areas. The part numbers of these assembly kits can be found on the corresponding Super-Alu-Trough page.

**Steel guide troughs** | For harsh environments



**ST** Steel guide troughs  
▶ from page 9.44

Guide trough Series Part No.	Outer trough height $H_{Ra}$ [mm]	Price index	Materials of side parts	Page
92.30 / 92.31	70	● ● ●	Galvanized steel*	9.44
95.30 / 95.31	100	● ● ●	Galvanized steel*	9.46
99.30 / 99.31	100	● ● ●	Galvanized steel*	9.48
97.30 / 97.31	130	● ● ●	Galvanized steel*	9.50
93.30 / 93.31	130	● ● ●	Galvanized steel*	9.52
94.30 / 94.31	170	● ● ●	Galvanized steel*	9.54
96.30 / 96.31	220	● ● ●	Galvanized steel*	9.56
98.30 / 98.31	300	● ● ●	Galvanized steel*	9.58
90.30 / 90.31	480	● ● ●	Galvanized steel*	9.60
91.10 - 91.51**	48	● ● ●	Galvanized steel*	9.63

\*Stainless steel on request    \*\*Steel guide troughs, one-piece

**Tubular trough system RS** | Lets debris through, and gives good visibility

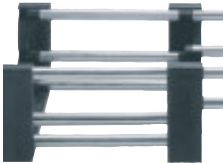

**RS** Tubular trough  
▶ from page 9.64

Guide trough Series Part No.	Outer trough height $H_{Ra}$ [mm]	Price index	Materials of side parts	Page
92.70 / 92.71	90	● ● ●	Galvanized steel / Polymer	9.64
93.70 / 93.71	146	● ● ●	Galvanized steel / Polymer	9.67
95.70 / 95.71	126,3	● ● ●	Galvanized steel / Polymer	9.67

**Snap-in trough system SP** | Simple and cost effective



**SP** Snap-in trough  
▶ from page 9.68

Guide trough Series Part No.	Outer trough height $H_{Ra}$ [mm]	Price index	Materials of side parts	Page
91.930	55,5	● ● ●	Galvanized steel	9.68
92.930	76,6	● ● ●	Galvanized steel	9.68
93.930	138,6	● ● ●	Galvanized steel	9.69
95.930	106,6	● ● ●	Galvanized steel	9.69

## igus® guide troughs

Guide troughs are used for long travels, (travels from 5 to 12 m) and greater, depending on the E-Chain® type. They allow to continue smooth, low-friction operation in these long-travel situations. If the E-Chains® are installed in the center of the travel ("center-mounted"), they glide on themselves for half the travel. For the other half, we recommend glide bars, which are assembled in the trough and on which the E-Chains® glide. igus® guide troughs are available from stock with these highly abrasion-resistant polymer glide bars, which perform well with igus® E-Chains® regarding noise, abrasion and friction.



Various guide trough systems are available



Various guide trough systems are available

### Trough type

igus® offers guide troughs made of corrosion-resistant aluminum, steel, stainless steel, as well as tubes and insert troughs (with steel side plates). The trough type to be used depends on the application conditions and the requirements of the customer. We recommend the igus® standard super aluminum guide troughs.

### Glide bars

Glide bars made of igulene are optimally matched to the E-Chain® material and achieve the lowest values for friction, noise and wear. Glide bars must be used, if the fixed point is in the center of the travel. It means: Use half of the guide trough with glide bars and the other half of the guide trough without glide bars.

### Delivery condition

The troughs are delivered in 2 meter sections. Special lengths up to 6 m are possible. The left and right side parts are installed on location with the appropriate distance - depending on the width of the E-Chain®. The necessary width is shown by the dimension  $B_{PI}$  on the guide trough pages. The E-Chain® sides can be linked with the base through screwing, welding or a special igus® installation set. The fixation module for the igus® Super-Alu-Trough is a quick fix for mounting the stationary end of an E-Chain® with a KMA-mounting bracket. With this new module a fast and easy mounting onto the Super-Aluminum-Trough is possible without any drilling  
 ► page 9.16.

### Own production

The dimensions quoted in this chapter are for design and installation. They apply exclusively to igus® guide trough systems. If a user of igus® E-Chains® produces own designs, the manufacturing and installation dimensions for the necessary guide trough must be obtained from igus®. This applies in particular to the use of one-piece guide troughs and the play between guide trough and E-Chain®, depending on chain type, chain length, size bending radius and tolerance of the moving end and the base. One must be particularly careful here, since a function-compatible setting during installation and a subsequent adjustment is not possible for such guide troughs.



Trough without glide bars -  
E-Chain® glides on E-Chain®



Trough with glide bars -  
E-Chain® glides on glide bars



Center mounted: 1/2 Travel with glide  
bars - 1/2 Travel without glide bars

For long travels, the upper run of the igus® E-Chains® rests on the lower run. The upper run glides partially on the lower run and partially at the same height on a glide bar. The diagrams below show this. For lateral guidance, a Guide Trough is necessary. If the stationary mounting bracket and the fixed end of the cables and hoses can be placed **in the center**, the E-Chain® length is calculated as follows:  $L_k = S/2 + K$ . The shortest E-Chain® length is attained by the axial feeder module. The length of the E-Chain® then corresponds to about half the travel distance. Depending on the technical data and the selected E-Chain®, the mounting point of the moving end of the E-Chain® must be lowered on some units. In our system analysis for long travels, we give exact details for your specific application.

**Selection criteria**

Following parameters are required for the design of a trough system:  
 ● E-Chain® type (Series, width  $B_i$ , radius  $R$ ) ● Travel and travel speed  
 ● Fill weight ● Acceleration and/or lagging ● Lateral accelerations ● Environmental conditions

**Design and installation of the guide trough**

The guide trough is an important element in long travel applications. Usually, the height of the trough must be at least twice that of the E-Chain® link height:  $H_{Ri} \geq 2 \times ha$ . The sides must provide a chamfered opening. The trough inner width is the same as the E-Chain® outer width, plus 5 mm ( $B_{Ri} = Ba + 4$ ). Along the side of the trough, where the upper run cannot glide on the lower run, glide bars must be installed. We recommend the use of polymer glide bars from igus®. They are optimally matched to the E-Chain® material and achieve the lowest values for friction, noise and wear. Guide troughs with and without glide bars can

<b>S</b>	=	Length of travel
<b>R</b>	=	Bending radius
<b>H<sub>F</sub></b>	=	Required clearance height
<b>K<sub>2</sub></b>	=	Further add-on (if the mounting bracket location is set lower)
<b>K</b>	=	$\pi \cdot R$ + "safety" Add-on for bending radius (K is taken from the data tables of the individual igus® Series)
<b>D<sub>2</sub></b>	=	Over length for long travels gliding
<b>Ba</b>	=	Outer E-Chain® width
<b>Bi</b>	=	Inner E-Chain® width
<b>ha</b>	=	Outer E-Chain® height
<b>H<sub>Ri</sub></b>	=	Inner trough height
<b>H<sub>Ra</sub></b>	=	Outer trough height
<b>H<sub>2</sub></b>	=	Mounting height (if the mounting bracket location is set lower)
<b>B<sub>Ri</sub></b>	=	Inner E-Chain® width ► depending on Ba
<b>B<sub>Ra</sub></b>	=	Guide trough outer width
<b>L<sub>k</sub></b>	=	E-Chain® length
<b>L<sub>k</sub> = S/2 + K   H<sub>Ri</sub> ≥ 2 x ha   B<sub>Ri</sub> ≥ Ba + 4</b>		
<span style="color: blue;">●</span>	Guide trough	<span style="color: grey;">●</span> Installation set "Basic"
<span style="color: lightblue;">●</span>	Glide bar	<span style="color: darkgrey;">●</span> C-profile

be obtained for almost all igus® E-Chains®. **Important: When assembling the trough parts, the following points must be given particular attention:** ● Properly align all trough parts upon installation ● All screw heads should be flush with the trough ● Smooth levelled transition between the end of the E-Chain® and the glide bars ● Solid connection with the glide surface. **These points must be observed when using assembly-friendly igus® guide troughs.**

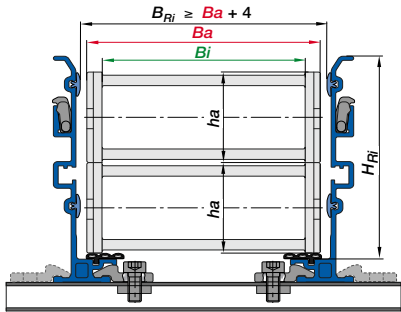

Guide troughs without glide bars - upper run glides on the lower run

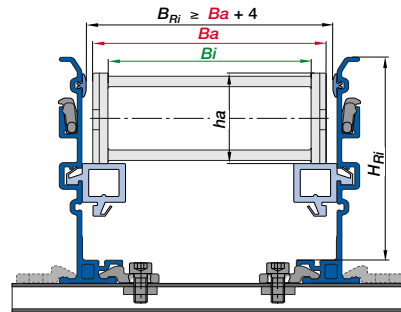

Guide troughs with glide bars - From the middle of the travel the upper run glides off on the glide bar

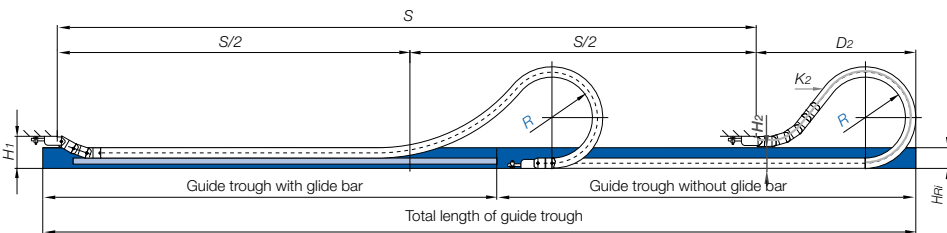

The function of an E-ChainSystem® for gliding applications

The fixed end of the E-Chain® is located in the center of the travel distance



Selected guide trough Series	Type	Part No. Aluminium SuperTrough	Optional noise dampening	Optional Heavy Duty	Part No. fixed end module ▶ page 9.16
10/B15.015	E2 mini	970.30.SL, 970.31.SL <b>NEW!</b>	–	–	–
10/B15.025	E2 mini	970.30.SL, 970.31.SL <b>NEW!</b>	–	–	–
10/B15.038	E2 mini	970.30.SL, 970.31.SL <b>NEW!</b>	–	–	–
10/B15.050	E2 mini	970.30.SL, 970.31.SL <b>NEW!</b>	–	–	–
10/B15.5	E2 mini	970.30.SL, 970.31.SL <b>NEW!</b>	–	–	–
15.015	Zipper	970.30.SL, 970.31.SL <b>NEW!</b>	–	–	–
15.025	Zipper	970.30.SL, 970.31.SL <b>NEW!</b>	–	–	–
15.038	Zipper	970.30.SL, 970.31.SL <b>NEW!</b>	–	–	–
15.050	Zipper	970.30.SL, 970.31.SL <b>NEW!</b>	–	–	–
15.5	Zipper	970.30.SL, 970.31.SL <b>NEW!</b>	–	–	–
1400/1450/1480/1500	E2/000	970.30.SL, 970.32.SL <b>NEW!</b>	–	–	–
2400/2450/2480/2500	E2/000	971.30.SL, 971.31.SL	●	●	971.80
2600/2650/2680/2700	E2/000	972.30.SL, 972.32.SL	●	●	972.81
3400/3450/3480/3500	E2/000	973.30.SL, 973.31.SL	●	●	973.80
200/240/250	E2 medium	971.30.SL, 971.31.SL	●	●	–
255	E2 medium	971.30.SL, 971.31.SL	●	●	–
26/27I/27	E2 medium	972.30.SL, 972.32.SL	●	●	–
340/350	E2 medium	973.30.SL, 973.31.SL	●	●	–
R48	E2 R	971.30.SL, 971.31.SL <b>NEW!</b>	●	●	–
R58 / R58 classic	E2 R	972.30.SL, 972.32.SL	●	●	–
R68 / R68 classic	E2 R	973.30.SL, 973.31.SL	●	●	–
210	E4/00	970.30.SL, 970.32.SL <b>NEW!</b>	–	–	–
220/R760	E4/00	972.02.30.SL, 972.02.31.SL <b>NEW!</b>	●	●	972.82
280/290/R770	E4/00	972.30.SL, 972.31.SL	●	●	972.80
380/390/R780	E4/00	973.30.SL, 973.31.SL	●	●	973.81
400/410/R880	E4/00	974.30.SL, 974.31.SL	●	●	974.80
2828/2928/R7728	E4/4	972.30.SL, 972.31.SL	●	●	972.80
3838/3938/R7838	E4/4	973.30.SL, 973.31.SL	●	●	973.81
4040/4140/R8840	E4/4	974.30.SL, 974.31.SL	●	●	974.80
4040HD/R8840HD	E4/4	974.30.SL, 974.31.SL	●	●	974.80
5050/5150/R9850	E4/4	975.30.SL, 975.31.SL <b>NEW!</b>	●	●	975.80
5050HD/R9850HD	E4/4	975.30.SL, 975.31.SL <b>NEW!</b>	●	●	975.80
140/141/R188	E4/light	974.30.SL, 974.31.SL	●	●	974.81
14040/14140/R18840	E4/light	974.30.SL, 974.31.SL	●	●	974.81
142/143	E4/light	974.30.SL, 974.31.SL	●	●	974.81
14240/14340	E4/light	974.30.SL, 974.31.SL	●	●	974.81
150/151/R198	E4/light	975.30.SL, 975.31.SL <b>NEW!</b>	●	●	975.80
15050/15150/R19850	E4/light	975.30.SL, 975.31.SL <b>NEW!</b>	●	●	975.80
22/23/R76	E4/0	972.02.30.SL, 972.02.31.SL <b>NEW!</b>	●	●	972.82
28/29/R77	E4/0	972.30.SL, 972.31.SL	●	●	972.80
38/39/R78	E4/0	973.30.SL, 973.31.SL	●	●	973.81
40/41/R88	E4/0	974.30.SL, 974.31.SL	●	●	974.80
50/51/R98	E4/0	975.30.SL, 975.31.SL	●	●	975.80
E6.29/R6.29	E6	971.30.SL, 971.31.SL	●	●	–
E6.35	E6	972.02.30.SL, 972.02.31.SL <b>NEW!</b>	●	●	972.82
E6.40/R6.40	E6	972.30.SL, 972.31.SL	●	●	972.80
E6.52/R6.52	E6	973.30.SL, 973.31.SL	●	●	973.81
E6.62	E6	974.30.SL, 974.31.SL	●	●	974.80
E6.80/E6.80L	E6	975.30.SL, 975.31.SL <b>NEW!</b>	●	●	975.80

● as option possible – not possible

### **New!** A quick fix for mounting the stationary end of an E-Chain®

With this new module for the fixed end, fast and easy mounting onto the Aluminum "SuperTrough" is now possible without any drilling. Fast mounting of the E-Chain® by clamping onto the aluminum trough ● Quick relocation of the stationary end ● No drilling necessary

Selected guide trough Series	Type	Part No.		
		Steel guide troughs	Tubular troughs	Snap-in troughs
10/B15.015	E2 mini	91.10, 91.11**	–	91.930
10/B15.025	E2 mini	91.20, 91.21**	–	91.930
10/B15.038	E2 mini	91.30, 91.31**	–	91.930
10/B15.050	E2 mini	91.40, 91.41**	–	91.930
10/B15.5	E2 mini	91.50, 91.51**	–	91.930
15.015	Zipper	91.10, 91.11**	–	–
15.025	Zipper	91.20, 91.21**	–	–
15.038	Zipper	91.30, 91.31**	–	–
15.050	Zipper	91.40, 91.41**	–	–
15.5	Zipper	91.50, 91.51**	–	–
2400/2450/2480/2500	E2/000	92.30, 92.31*	92.70, 92.71	92.930
2600/2650/2680/2700	E2/000	95.30, 95.31*	95.70, 95.71	95.930
3400/3450/3480/3500	E2/000	93.30, 93.31*	93.70, 93.71	93.930
200/240/250	E2 medium	92.30, 92.31*	92.70, 92.71	92.930
255	E2 medium	92.30, 92.31*	92.70, 92.71	–
26/27i/27	E2 medium	95.30, 95.31*	95.70, 95.71	95.930
340/350	E2 medium	93.30, 93.31*	93.70, 93.71	93.930
R58 / R58 classic	E2 R	95.30, 95.31*	–	–
R68 / R68 classic	E2 R	93.30, 93.31*	–	–
220/R760	E4/00	99.30, 99.31*	–	–
280/290/R770	E4/00	97.30, 97.31*	–	–
380/390/R780	E4/00	93.30, 93.31*	–	–
400/410/R880	E4/00	94.30, 94.31*	–	–
600/601/R608	E4/00	98.30, 98.31*	–	–
640	E4/00	98.30, 98.31*	–	–
800/840	E4/00	90.30, 90.31*	–	–
2828/2928/R7728	E4/4	97.30, 97.31*	–	–
3838/3938/R7838	E4/4	93.30, 93.31*	–	–
4040/4140/R8840	E4/4	94.30, 94.31*	–	–
4040HD/R8840HD	E4/4	94.30, 94.31*	–	–
5050/5150/R9850	E4/4	96.30, 96.31*	–	–
5050HD/R9850HD	E4/4	96.30, 96.31*	–	–
140/141/R188	E4/light	94.30, 94.31*	–	–
14040/14140/R18840	E4/light	94.30, 94.31*	–	–
142/143	E4/light	94.30, 94.31*	–	–
14240/14340	E4/light	94.30, 94.31*	–	–
150/151/R198	E4/light	96.30, 96.31*	–	–
15050/15150/R19850	E4/light	96.30, 96.31*	–	–
1640/1608	E4/light	98.30, 98.31*	–	–
22/23/R76	E4/0	99.30, 99.31*	–	–
28/29/R77	E4/0	97.30, 97.31*	–	–
38/39/R78	E4/0	93.30, 93.31*	–	–
40/41/R88	E4/0	94.30, 94.31*	–	–
50/51/R98	E4/0	96.30, 96.31*	–	–
E6.29/R6.29	E6	92.30, 92.31*	92.70, 92.71	92.930
E6.35	E6	99.30, 99.31*	–	–
E6.40	E6	97.30, 97.31*	–	–
E6.52/R6.52	E6	93.30, 93.31*	93.70, 93.71	93.930
E6.62	E6	94.30, 94.31*	–	–
E6.80 / E6.80L	E6	96.30, 96.31*	–	–

\*Stainless steel on request \*\*Steel guide troughs, one-piece

A detailed cross-sectional view of a window frame assembly. The central vertical element is a dark grey frame profile. To its right is a grey metal block with two cylindrical protrusions, one at the top and one at the bottom. A roller is visible within the frame's channel, resting on a track. A black seal is positioned between the frame and the metal block. The background is a solid blue color.

# Alu Super Trough



**Aluminium "SuperTrough" -  
The igus® standard guide trough**

- Modular design in two versions - Basic and Heavy Duty
- Very simple, modular assembly
- Side-mounted glide strips for wear protection in high-speed
- Corrosion resistant, seawater resistant aluminium profile
- Flexible assembly - Fastening on substructure independent of profile lengths and butt joints
- Interface connector - Plastic with snap-in connection
- Plastic glide bar made of PE
- Bottom clamp can be mounted -inside or outside- directly on the bottom or on the c-profile
- Glide strips and silencer profile for the minimization of the noise level
- Heavy duty brackets for safe connection also for rough applications
- C-profile for the fixation of the bottom clamp or Heavy duty brackets
- Fixed end module for fast and easy mounting onto the Aluminium "SuperTrough" - without any drilling

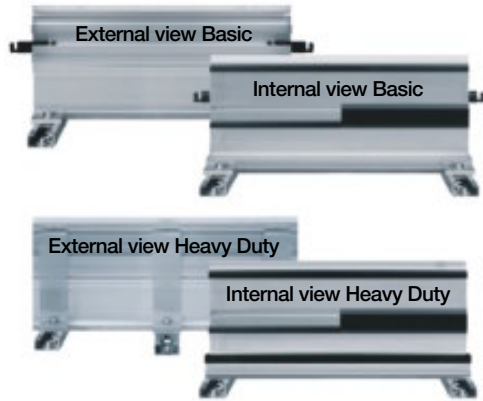

Aluminium "SuperTrough" is available in low cost "basic versions" and can be upgraded for heavy duty applications

**Aluminium "SuperTrough" - Overview of sizes**

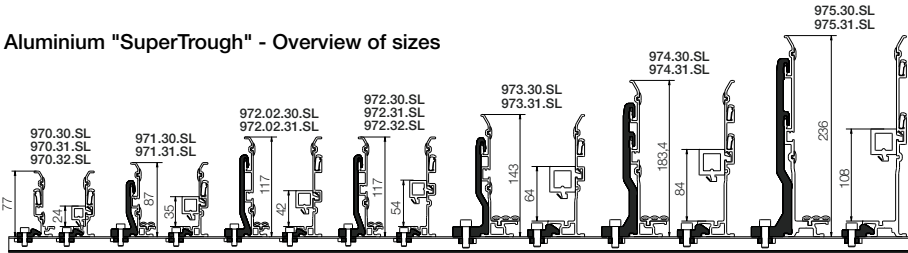

**Super-Alu trough configuration according to your requirements**

**Assemble the right trough suited for your application quickly and easily**

- Selection of the suitable guide trough according to the E-Chain® Series and E-Chain® width *Bi* ► **page 9.10**
- Determine the feeding point of the cables ► **page 9.9**
- Determine travel distance and thus the length of the required guide trough and the number of trough pieces. (Standard length of a trough side plate: 2000 mm). The length of the guide trough - for axial feeding - is calculated from half the travel length **with** and half the travel length **without** the glide bar
- Option: "Sound dampening" with silencer profile ► **page 9.15**
- Number and selection of the assembly kit ► **page 9.14/9.15:**

There are two assembly kit options: Basic (standard), Heavy Duty (for plant construction)

**The quantity of the assembly kit is calculated from the number of the trough pieces + 1 kit:**

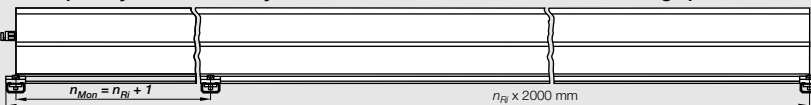

- Selection of the fastening of the assembly kit on the subsurface - igus® C rails option
- If you have opted for an E-Chain® with KMA mounting brackets, we offer you a fixed-end module for the quick and simple fastening of the E-Chain® in the trough without holes ► **page 9.16**

## Aluminium "SuperTrough" | Advantages

### Aluminum "Super Trough"- the igus® standard

The Aluminum "SuperTrough" is a modular guide trough system for long travels (when E-Chains® glide on themselves). Aluminum "Super-Trough" is available in low cost "basic versions" and can be upgraded for heavy duty applications. **This modular usage makes it the igus® recommended new standard trough system.**

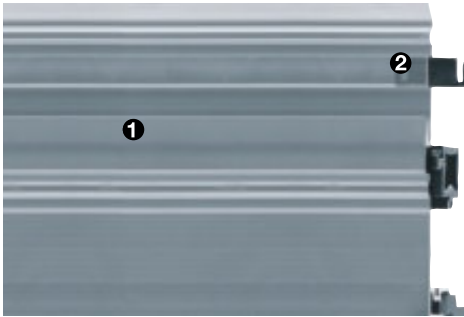
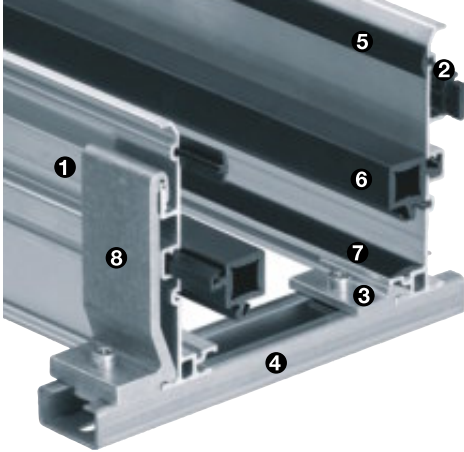

### Huge program

- ① Aluminium profile (Standard: 2 m section)
  - Fitted to the igus® E-Chain® program
  - For almost all igus® E-Chains® available
  - Seawater resistant and corrosion resistant

### Fast connection

- ② Interface connector "Basic"
  - Snap-on polymer connector
  - Easy assembly, no tools needed
  - Simply clipped on firmly in the provided slot

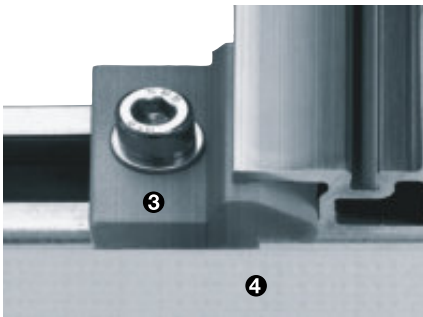

### Simple fastening

- ③ Bottom clamp "Basic"
  - Fast and easy single-bolt assembly
  - Slider attached inwards or outwards, directly to the ground or onto a C-profile
  - Standard assembly kit for igus® Super-Alu troughs
  - Ideal for general mechanical engineering
- ④ C-profile
  - Hold Bottom clamps or heavy duty brackets
  - Available in zinc-plated or stainless steel



### Misalignment-free installation

- Screwing or welding of the profiles not required
- Manifold fastening potentials with bracket, clamping shoe and connectors
- Flexible fastening on substructure independent of profile lengths and butt joints
- No screw heads sticking out inwards
- Even change-over between E-Chain® connection and glide bar

**Wear-reducing**

⑤ **Polymer glide bar**

- Easy click-on assembly (tongue and groove), no tools needed
- Even support due to the special slot design
- Glide bars are ideally suited for the E-Chain® material
- Minimum coefficients in terms of friction noise and wear

⑥ **Glide strip**

- Protect from wear on the sides
- Easy click-on assembly (tongue and groove), no tools needed

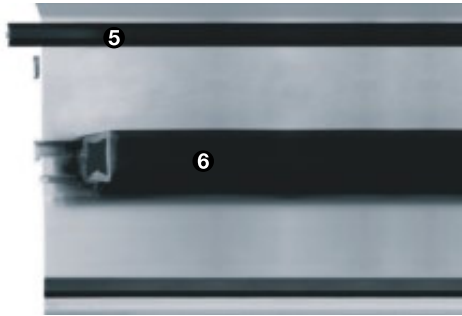

**Noise-reducing**

⑦ **Silencer profile (add-on item)**

- Rubber profile insert for additional noise reduction
- Excellent wear and sound values when applied with igus® E-Chain® systems: In combination with optimized igus® roller E-Chain® and "dampening profile" of the Super-Alu trough, a distinct reduction in noise reduction of 9.0 dB (A) is evident
- Can be optionally ordered

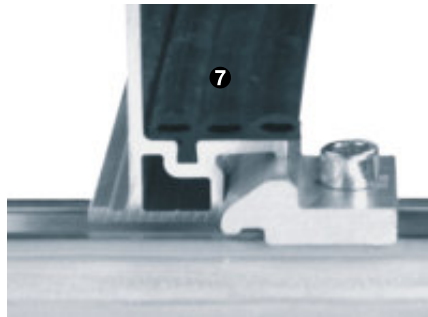

**Heavy stress**

⑧ **Heavy duty bracket (add-on item)**

- Safe grip for heavy duty operation
- Easy tongue and groove assembly
- Attached directly to ground or to C-profiles
- Can be optionally ordered

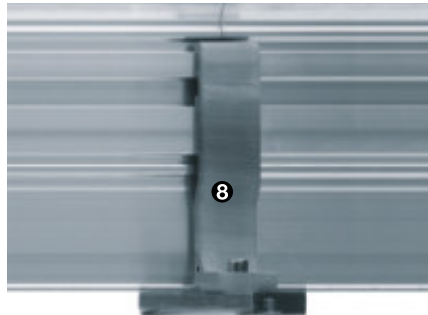

**Simple connection to the E-Chain®**

⑨ **Fixed end module**

- **NEW!** Quick assistance while fastening of the E-Chain® fixed end on the Super-Alu trough
- Fixed end module for fast and easy mounting onto the Aluminium "SuperTrough" - without any drilling
- Can be optionally ordered - Recommended for E-Chain® with KMA mounting bracket in conjunction with igus® Super-Alu trough

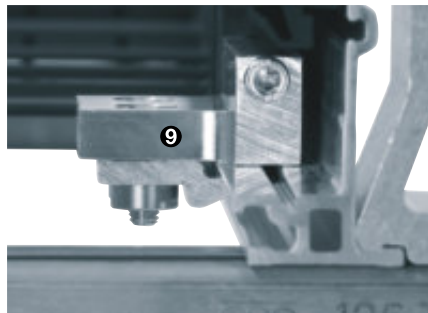

Aluminium "Super Trough"

Phone +49- (0) 22 03-96 49-800  
Fax +49- (0) 22 03-96 49-222



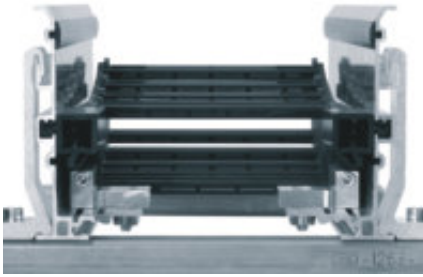

**New! A quick fix for mounting the stationary end of an E-Chain®**

With this new module for the fixed end, fast and easy mounting onto the Alu "SuperTrough" is now possible without any drilling. Fast mounting of the E-Chain® by clamping onto the alu trough ● Quick relocation of the stationary end ● No drilling necessary

**Installation - A) Fixed-end module, B) KMA mounting bracket**

- ① Removing the preassembled metal bushings
- ② Use of threaded bushings
- ③ Installation fixed-end module
- ④ Mounting on Super-Alu trough

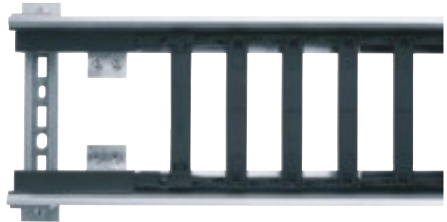
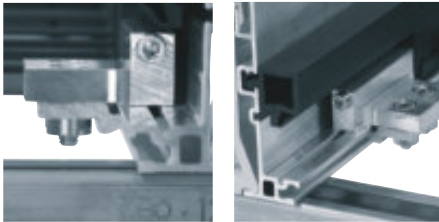
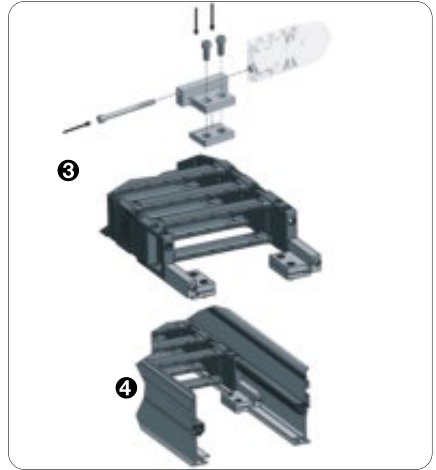
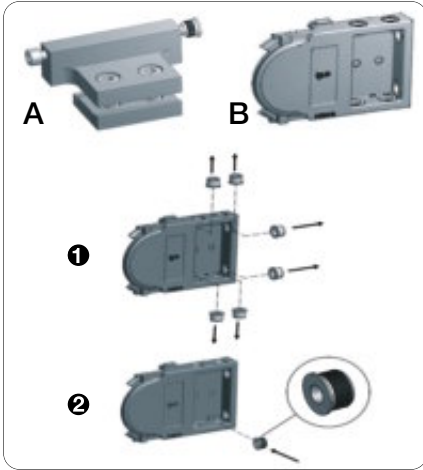

Fixed-end module - Simple fastening of the E-Chain® without drilling

Part No.	For Aluminum-SuperTrough	For Series	Application including Inner width (B)
971.80	971.30.SL / 971.31.SL	2400/2450/2480/2500, 255	.07
972.82	972.02.30.SL / 972.02.31.SL	220/R760, E6.35	.06
972.81	972.30.SL / 972.32.SL	2600/2650/2680/2700	.06
972.80	972.30.SL / 972.31.SL	280/290/R770, 2828/2928/R7728, E6.40/R6.40	.06
973.81	973.30.SL / 973.31.SL	380/390/R780, 3838/3938/R7838, E6.52/R6.52	.10
973.80	973.30.SL / 973.31.SL	3400/3450/3480/3500	.100
974.81	974.30.SL / 974.31.SL	14040/14140/R18840, 14240/14340	.10
974.80	974.30.SL / 974.31.SL	400/410/R880, 4040/4140/R8840, E6.62	.10
975.80	975.30.SL / 975.31.SL	5050/5150/R9850, 15050/15150/R19850, E6.80/E6.80L	.10

Material assembly kits: Aluminum AlMg3, seawater resistant

Material screw kits: Standard steel, galvanized. Also available in stainless steel 1.4571 as an option: e.g. 974.80.E4





The igus® Super-Alu trough has been used in test setups since 2005.

Test setup "Axis 1": Speed 1.5 m/s, Travel: 18 m, Mileage so far: about 50,000 km (test runs since 2005)



Test - Glide strips minimize wear after 1.653.187 cycles, 4.300 km

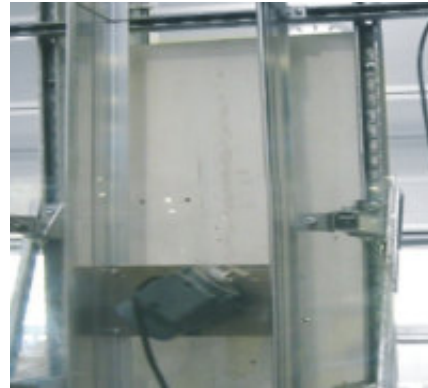

Vibration test: No shifting of trough sections after 108.000.000 rotations at 658 rpm.

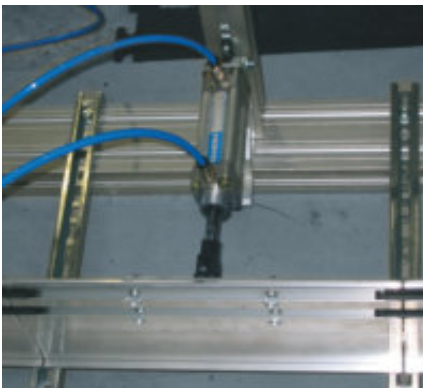

Test - Interface connector

- Push/pull force of 350N
- 9.890.000 cycles without shifting of the connector

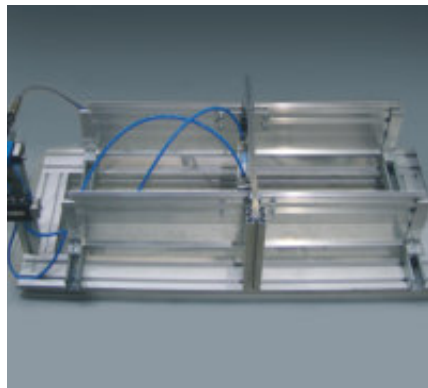

Alternating push- and pull force of 400N is induced on 2 trough side parts, with no deformation after 1.700.000 cycles

Phone +49- (0) 22 03-96 49-800  
Fax +49- (0) 22 03-96 49-222

AL

ST

RS

SP

Installation sets | Basic and Heavy Duty

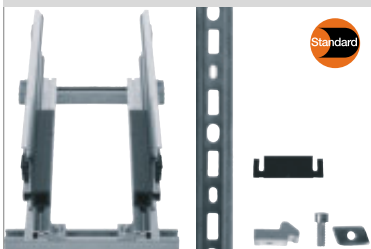

Installation set Basic



Installation set Heavy Duty

Pre-assembly of installation set | Basic - The Standard!

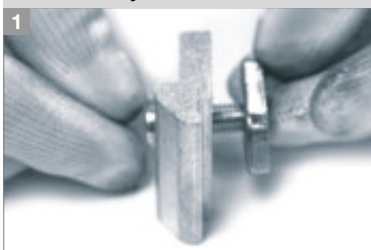

Pre-assemble the clamping shoe and the screw kit



Clip in polymer connector on both sides of the designated support

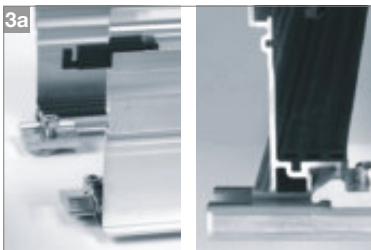

Fasten Basic assembly set Basic inside ③a or outside ③b (Check stability of the fixing). Please note: half the length of the assembly set and connector must protrude out of the trough. The glide nut should be well fastened in the C-profile

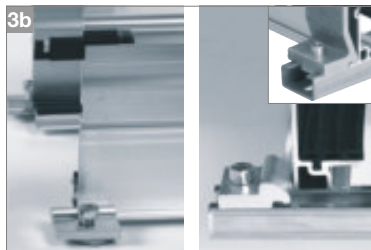

Pre-assembly of installation set | Heavy Duty (alternative)



① Pre-assemble heavy duty bracket and screw set



② Fasten Heavy Duty assembly set outside. Please note: half the length of the assembly set and connector must protrude out of the trough

**Assembly | Adding the rubber profile (optional)**



Cut the rubber profile in accordance to the length of the trough (standard 2 m) and press it into the designated groove. (Pictured: Left and right sides are the same. To be repeated for each trough section.)

**Connecting | Trough sections**



- 1 Join the sides of the trough side parts by pushing them together (min. +2 mm gap!)
- 2 + 3 The pre-assembled parts join each trough section centrally

**Adjusting the tolerance | Aligning trough sections**



- 1 Adjust by the necessary minimum "E-Chain"/trough" tolerance of 2 mm on both sides. Please note: the inner width  $B_{PI}$  of the trough decreases 2 mm per side with the assembled glide strip (pictured)
- 2 Test to ensure the E-Chain" runs problem free and with low friction in the channel
- 3 After adjusting the minimum tolerance and alignment of all trough sections, please pull tight all screw tight connections. Pay attention thereby to the correct installation direction of the sliding nut (see detail) Starting torque of the assembly set's fixing bolts: M6: 10 Nm / M8: 23 Nm.

**Tools for the assembling of the SuperTrough**

- Pictogram aid: Hand
- Pictogram aid: Rubber hammer
- Pictogram aid: Hexagonal wrench
- Pictogram aid: Ruler

! Please consider health & safety regulations while handling sheet metals. We recommend using protective Category II gloves to protect against cuts when handling the aluminium profiles.





For the following  
E-Chains®/E-Tubes:

**System E2 Series**

- 10
- B15
- Zipper Series
- 15/R15

$B_a$  = Outer E-Chain® width  
 $B_i$  = Inner E-Chain® width  
 $h_a$  = E-Chain® outer height  
 $H_{Ri}$  = Inner trough height  
 $H_{Ra}$  = Outer trough height  
 $B_{Ri}$  = Inner trough width ▶  
depends on dim.  $B_a$   
 $B_{Ra}$  = Outer trough width

!  $H_{Ri} \geq 2 \cdot h_a$   
■  $B_{Ri} \geq B_a + 4$

- = Guide trough
- = Glide bar
- = Installation set "Basic"
- = C-profile



**Calculation - travel center mounted**

Half travel length, rounded down to full 2 m sections =  $X$  m **guide trough length without glide bars** +  $X$  m **guide trough length with glide bars** + installation sets "Basic" (number of trough pieces + 1)

Supplement Part No. with the indicated C-profile-length-index.  
**Example:** 960.30.125

C-profile length-index for your chosen trough inner width  $B_{Ri}$  ▶ see table on the right or the respective page for chosen series



**Fixed end module** - A quick fix for mounting the stationary end of an E-Chain® ▶ page 9.16

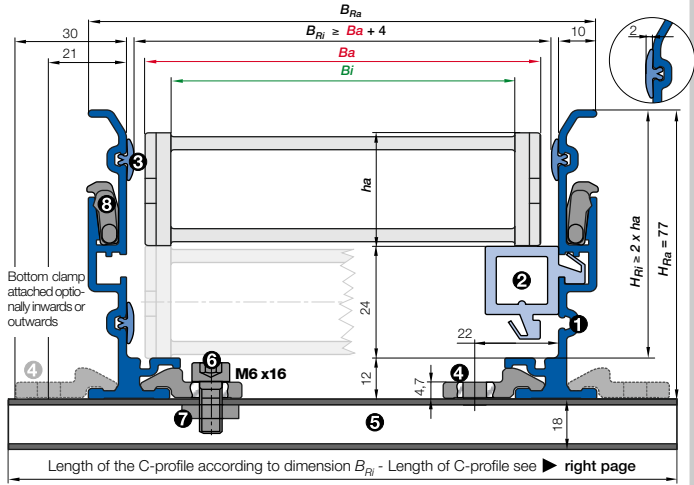

- **Components, trough "Basic":** ① Trough side parts, aluminum, 2 m ② Glide bar, plastic, 2 m ③ Glide strips, plastic, 2 m (without glide strips on request)
- **Components, installation set "Basic":** ④ Bottom clamp, aluminum ⑤ C-profile, steel galvanized ⑥ Screw M6 x 16 ⑦ Sliding nut M6 ⑧ Interface connector, plastic

**Basic version: Aluminum "SuperTrough" components**

Complete guide trough sets - description	Part No.	Weight
① Set of 2 trough side parts, incl. glide strips, without glide bars, 2 m section	970.30.SL	≈ 4,20 kg
① Set of 2 trough side parts, incl. glide strips, with glide bars, 2 m section	970.31.SL	≈ 4,90 kg
1 Installation set "Basic" without C-profile	960.30	≈ 0,06 kg
1 Installation set "Basic" with C-profile	960.30. <input type="text"/>	
Single parts - description		
③ 1 Glide strip, individual, 2 m section	75.01	≈ 0,06 kg
④ 1 Bottom clamp, individual	75.40	≈ 0,03 kg
⑧ 1 Interface connector, individual	75.60	
⑥ 1 Screw M6 x 16, individual	MAT 0040209	
⑦ 1 Sliding nut M6, individual	MAT 0040057	
② 1 Glide bar, individual, 2 m section	82.79	≈ 0,42 kg
⑤ 1 C-profile, individual	92.52. <input type="text"/>	≈ 0,90 kg/m



**Order example: Length of travel 30 m - Center mounted for Series 10.5.038.0 with  $B_{Ri} = 53$**

Guide trough set (set of 2 trough side parts, incl. glide strips) <b>without</b> glide bar		
<b>Order text:</b> 16 m guide trough without glide bar (8 x 2 m sections)	<b>Part No.</b>	970.30.SL
Guide trough set (set of 2 trough side parts, incl. glide strips) <b>with</b> glide bar		
<b>Order text:</b> 16 m guide trough with glide bar (8 x 2 m sections)	<b>Part No.</b>	970.31.SL
Installation set "Basic" complete (guide trough-sets + 1)		
<b>Order text:</b> 17 installation sets "Basic"	<b>Part No.</b>	960.30.125

Lengths of C-profile for Basic version - Bottom clamp attached optionally **inwards** or **outwards**

10				B15				15/R15			
10.5.038.0				B15.5.038.0				15.5.038.0			
$B_{Rl}$ [mm]	Part No. attached inwards	Part No. attached outwards		$B_{Rl}$ [mm]	Part No. attached inwards	Part No. attached outwards		$B_{Rl}$ [mm]	Part No. attached inwards	Part No. attached outwards	
.015	30	*	960.30.125	.015	30	*	960.30.125	.015	30	*	960.30.125
.025	40	*	960.30.150	.025	40	*	960.30.150	.025	40	*	960.30.150
.038	53	*	960.30.150	.038	53	*	960.30.150	.038	53	*	960.30.150
.050	65	960.30.125	960.30.175	.050	65	960.30.125	960.30.175	.050	65	960.30.125	960.30.175
.5	80	960.30.125	960.30.175	.5	80	960.30.125	960.30.175	.5	80	960.30.125	960.30.175
.6	98	960.30.150	960.30.200	.6	98	960.30.150	960.30.200	.6	98	960.30.150	960.30.200
.7	117	960.30.175	960.30.225	.7	117	960.30.175	960.30.225	.7	117	960.30.175	960.30.225

\*upon request

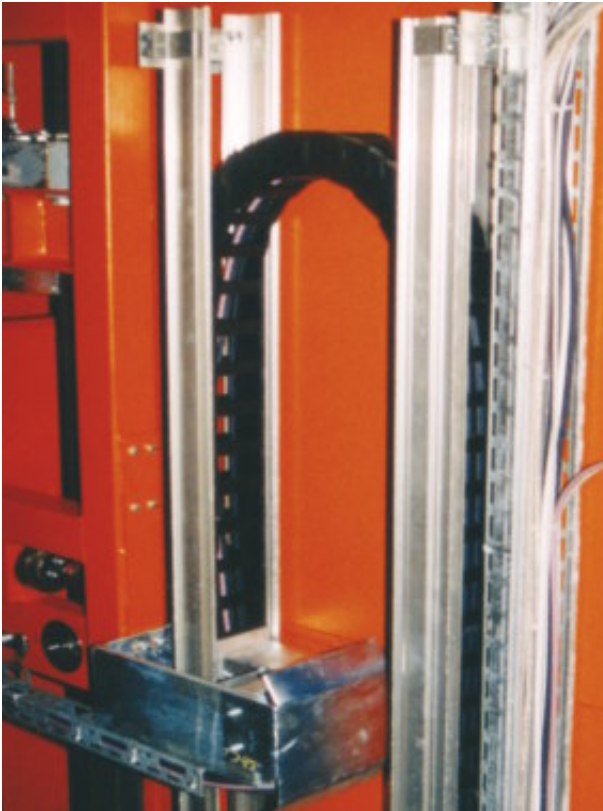

E-Chain® on the tower of the storage and retrieval unit for high-bay warehouses rolls off from one aluminum guide trough to the opposite one



For the following  
E-Chains®/E-Tubes:

**System E2 Series**

- 1400/1450/1480/1500

**System E4 Series**

- 210

$B_a$  = Outer E-Chain® width  
 $B_i$  = Inner E-Chain® width  
 $h_a$  = E-Chain® outer height  
 $H_{Ri}$  = Inner trough height  
 $H_{Ra}$  = Outer trough height  
 $B_{Ri}$  = Inner trough width ▶  
depends on dim.  $B_a$   
 $B_{Ra}$  = Outer trough width

!  $H_{Ri} \geq 2 \cdot h_a$   
■  $B_{Ri} \geq B_a + 4$

- = Guide trough
- = Glide bar
- = Installation set "Basic"
- = C-profile



**Calculation - travel center mounted**

Half travel length, rounded down to full 2 m sections =  $X$  m **guide trough length without glide bars** +  $X$  m **guide trough length with glide bars** + installation sets "Basic" (number of trough pieces + 1)

Supplement Part No. with the indicated C-profile-length-index.  
**Example:** 960.30.125

C-profile length-index for your chosen trough inner width  $B_{Ri}$  ▶ see table on the right or the respective page for chosen series



**Fixed end module** - A quick fix for mounting the stationary end of an E-Chain® ▶ page 9.16

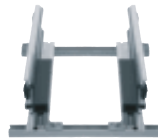
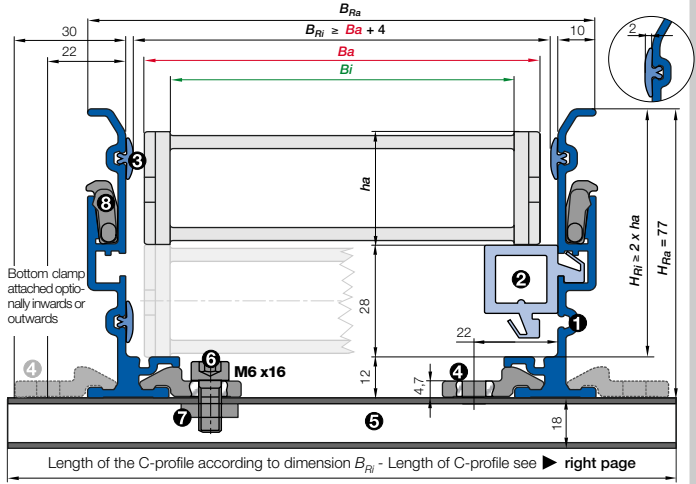

- **Components, trough "Basic":** ① Trough side parts, aluminum, 2 m ② Glide bar, plastic, 2 m ③ Glide strips, plastic, 2 m (without glide strips on request)
- **Components, installation set "Basic":** ④ Bottom clamp, aluminum ⑤ C-profile, steel galvanized ⑥ Screw M6 x 16 ⑦ Sliding nut M6 ⑧ Interface connector, plastic

**Basic version: Aluminum "SuperTrough" components**

Complete guide trough sets - description	Part No.	Weight
① Set of 2 trough side parts, incl. glide strips, without glide bars, 2 m section	970.30.SL	≈ 4,20 kg
① Set of 2 trough side parts, incl. glide strips, with glide bars, 2 m section	970.32.SL	≈ 5,00 kg
1 Installation set "Basic" without C-profile	960.30	≈ 0,06 kg
1 Installation set "Basic" with C-profile	960.30. <input type="text"/>	
Single parts - description		
③ 1 Glide strip, individual, 2 m section	75.01	≈ 0,06 kg
④ 1 Bottom clamp, individual	75.40	≈ 0,03 kg
⑧ 1 Interface connector, individual	75.60	
⑥ 1 Screw M6 x 16, individual	MAT 0040209	
⑦ 1 Sliding nut M6, individual	MAT 0040057	
② 1 Glide bar, individual, 2 m section	82.79	≈ 0,42 kg
⑤ 1 C-profile, individual	92.52. <input type="text"/>	≈ 0,90 kg/m



**Order example: Length of travel 30 m - Center mounted for Series 1500.050.035.0 with  $B_{Ri} = 68$**

Guide trough set (set of 2 trough side parts, incl. glide strips) <b>without</b> glide bar	<b>Order text:</b> 16 m guide trough without glide bar (8 x 2 m sections)	<b>Part No.</b> 970.30.SL
Guide trough set (set of 2 trough side parts, incl. glide strips) <b>with</b> glide bar	<b>Order text:</b> 16 m guide trough with glide bar (8 x 2 m sections)	<b>Part No.</b> 970.32.SL
Installation set "Basic" complete (guide trough-sets + 1)	<b>Order text:</b> 17 installation sets "Basic"	<b>Part No.</b> 960.30.125



Lengths of C-profile for Basic version - Bottom clamp attached optionally **inwards** or **outwards**

1400/1450/1480/1500			210		
1500.050.035.0			210.080.100.0		
$B_{Rl}$ [mm]	Part No. attached inwards	Part No. attached outwards	$B_{Rl}$ [mm]	Part No. attached inwards	Part No. attached outwards
.015 33	*	960.30.125	.030 48	*	960.30.150
.020 38	*	960.30.125	.040 58	960.30.125	960.30.150
.025 43	*	960.30.150	.050 68	960.30.125	960.30.175
.038 56	*	960.30.150	.060 78	960.30.125	960.30.175
.050 68	960.30.125	960.30.175	.070 88	960.30.150	960.30.175
.068 86	960.30.150	960.30.175	.080 98	960.30.150	960.30.200
.080 98	960.30.150	960.30.200	.090 108	960.30.175	960.30.200
.100 118	960.30.175	960.30.225	.100 118	960.30.175	960.30.225
.125 143	960.30.200	960.30.250	.110 128	960.30.175	960.30.225
			.120 138	960.30.200	960.30.225

\*upon request



Seawater resistant super-alu-trough in a RTG-crane. Long travel with the E4/4 system





For the following  
E-Chains®/E-Tubes:

**System E2 Series**

- 2400/2450/2480/2500
- 255
- 200/240/250 classic

**System E2 E-Tubes**

- R48

**System E6 Series**

- E6.29/R6.29

$B_a$  = Outer E-Chain® width  
 $B_i$  = Inner E-Chain® width  
 $h_a$  = E-Chain® outer height  
 $H_{Ri}$  = Inner trough height  
 $H_{Ra}$  = Outer trough height  
 $B_{Ri}$  = Inner trough width  
depends on dim.  $B_a$   
 $B_{Ra}$  = Outer trough width

!  $H_{Ri} \geq 2 \cdot h_a$   
■  $B_{Ri} \geq B_a + 4$

- = Guide trough
- = Glide bar
- = Installation set "Basic"
- = C-profile



**Calculation - travel center mounted**

Half travel length, rounded down to full 2 m sections =  $X$  m **guide trough length without glide bars** +  $X$  m **guide trough length with glide bars** + installation sets "Basic" (number of trough pieces + 1)

Supplement Part No. with the indicated C-profile-length-index.  
**Example:** 960.30.150  
C-profile length-index for your chosen trough inner width  $B_{Ri}$  ▶ see table on the right or the respective page for chosen series



**Fixed end module** - A quick fix for mounting the stationary end of an E-Chain® ▶ **page 9.16**

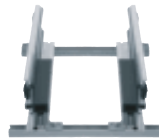
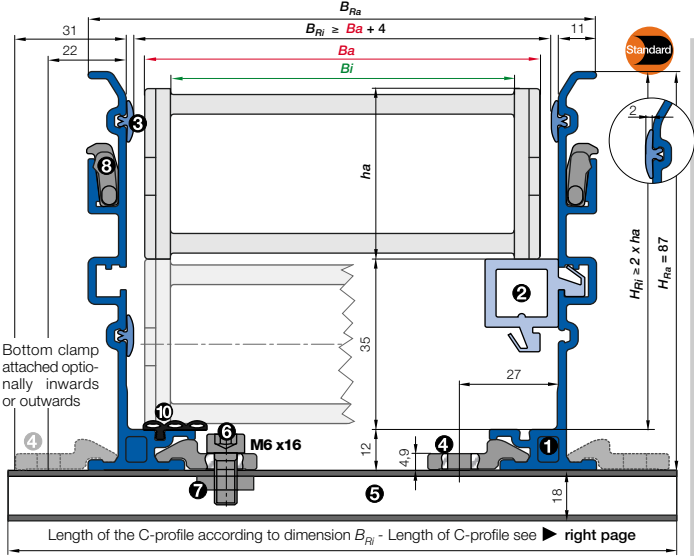

- **Components, trough "Basic":** ① Trough side parts, aluminum, 2 m ② Glide bar, plastic, 2 m ③ Glide strips, plastic, 2 m (without glide strips on request) ⑩ Optional: Silencer profile, rubber
- **Components, installation set "Basic":** ④ Bottom clamp, aluminum ⑤ C-profile, steel galvanized ⑥ Screw M6 x16 ⑦ Sliding nut M6 ⑧ Interface connector, plastic

**Basic version: Aluminum "SuperTrough" components**

Complete guide trough sets - description	Part No.	Weight kg
① Set of 2 trough side parts, incl. glide strips, without glide bars, 2 m section	971.30.SL	≈ 5,00 kg
① Set of 2 trough side parts, incl. glide strips, with glide bars, 2 m section	971.31.SL	≈ 6,40 kg
1 Installation set "Basic" without C-profile	960.30	≈ 0,06 kg
1 Installation set "Basic" with C-profile	960.30. <input type="text"/>	
Single parts - description		
③ 1 Glide strip, individual, 2 m section	75.01	≈ 0,06 kg
⑩ 1 Silencer profile, rubber, individual, 2 m section	75.67.H	
④ 1 Bottom clamp, individual	75.40	≈ 0,03 kg
⑧ 1 Interface connector, individual	75.60	
⑥ 1 Screw M6 x 16, individual	MAT 0040209	
⑦ 1 Sliding nut M6, individual	MAT 0040057	
② 1 Glide bar, individual, 2 m section	82.79	≈ 0,60 kg
⑤ 1 C-profile, individual	92.52. <input type="text"/>	≈ 0,90 kg/m



**Order example: Length of travel 30 m - Center mounted for Series 2400.07 with  $B_{Ri} = 97$**

Guide trough set (set of 2 trough side parts, incl. glide strips) <b>without</b> glide bar	<b>Order text:</b> 16 m guide trough without glide bar (8 x 2 m sections)	<b>Part No.</b>	971.30.SL
Guide trough set (set of 2 trough side parts, incl. glide strips) <b>with</b> glide bar	<b>Order text:</b> 16 m guide trough with glide bar (8 x 2 m sections)	<b>Part No.</b>	971.31.SL
Installation set "Basic" complete (guide trough-sets + 1)	<b>Order text:</b> 17 installation sets "Basic"	<b>Part No.</b>	960.30.150
Module for the fixed end	<b>Order text:</b> 1 set		971.80
<b>Option:</b> For an additional noise dampening with silencer profile, please add Index A Example:		<b>Part No.</b>	971.30.SLA

Lengths of C-profile for Basic version - Bottom clamp attached optionally inwards or outwards

2400/2450/2480/2500				255				E6.29/R6.29				R48			
2400.02.200.0				255.03.200.0				E6.29.030.100.0				48.050.100.0			
$B_{Rl}$ [mm]	Part No. attached inwards	Part No. attached outwards		$B_{Rl}$ [mm]	Part No. attached inwards	Part No. attached outwards		$B_{Rl}$ [mm]	Part No. attached inwards	Part No. attached outwards		$B_{Rl}$ [mm]	Part No. attached inwards	Part No. attached outwards	
.02	45	*	960.30.150	.03	58	*	960.30.150	.030	50	*	960.30.150	.025	40	*	960.30.150
.03	58	*	960.30.150	.05	77	960.30.125	960.30.175	.040	60	*	960.30.175	.050	65	*	960.30.175
.05	77	960.30.125	960.30.175	.07	97	960.30.150	960.30.200	.050	70	*	960.30.175	.075	90	960.30.150	960.30.200
.07	97	960.30.150	960.30.200	.10	123	960.30.175	960.30.225	.060	80	960.30.150	960.30.175	.100	115	960.30.175	960.30.225
.09	109	960.30.175	960.30.225					.070	90	960.30.150	960.30.200	.130	145	960.30.200	960.30.250
.10	123	960.30.175	960.30.225					.080	100	960.30.150	960.30.200				
.12	145	960.30.200	960.30.250					.090	110	960.30.175	960.30.225				
								.100	120	960.30.175	960.30.225				
								.110	130	960.30.200	960.30.225				
								.120	140	960.30.200	960.30.250				

\*upon request



Safely guide the E-Chain® across longer travel. Nowadays, users increasingly prefer aluminum (corrosion resistance, weight savings, faster assembly among others)

"Heavy Duty" Version | Installation set Part No. 971.50

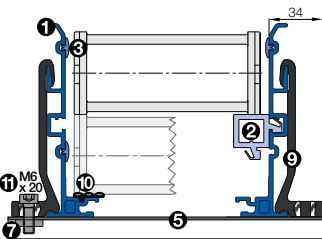

- Components, trough "Heavy Duty": ❶ Trough side parts, aluminum, 2 m ❷ Glide bar, plastic, 2 m ❸ Glide strips, plastic 2 m (without glide strips on request) ❹ Optional: Silencer profile, rubber
- Components, installation set "Heavy Duty": ❺ C-profile, steel galvanized ❽ Sliding nut M6 ❾ Heavy duty bracket, aluminum ❿ Screw M6 x 20

Note: Dimensions similar to Basic version!  
Exception: Heavy duty bracket, see drawing



- = Guide trough
- = Glide bar
- = Installation set "Heavy duty"
- = C-profile

Insert for the installation set "Heavy-Duty": **971.50.XXX** instead of 960.30.XXX on the right column "attached outwards"

"Heavy Duty" installation set Part No. 971.50.150

igus® E-ChainSystems®

Phone +49- (0) 22 03-96 49-800  
Fax +49- (0) 22 03-96 49-222

igus® GmbH  
51147 Cologne

Internet: www.igus.de  
E-mail: info@igus.de



For the following  
E-Chains®/E-Tubes:

**System E4 Series**

- 220/R760
  - 22/23/R76 classic
- System E6 Series**
- E6.35

- $B_a$  = Outer E-Chain® width
- $B_i$  = Inner E-Chain® width
- $h_a$  = E-Chain® outer height
- $H_{Ri}$  = Inner trough height
- $H_{Ra}$  = Outer trough height
- $B_{Ri}$  = Inner trough width
- depends on dim.  $B_a$
- $B_{Ra}$  = Outer trough width

!  $H_{Ri} \geq 2 \cdot h_a$   
■  $B_{Ri} \geq B_a + 4$

- = Guide trough
- = Glide bar
- = Installation set "Basic"
- = C-profile



**Calculation - travel center mounted**

Half travel length, rounded down to full 2 m sections =  $X$  m **guide trough length without glide bars** +  $X$  m **guide trough length with glide bars** + **installation sets "Basic"** (number of trough pieces + 1)

Supplement Part No. with the indicated C-profile-length-index.  
**Example:** 960.30.175  
C-profile length-index for your chosen trough inner width  $B_{Ri}$  ▶ see table on the right or the respective page for chosen series



**Fixed end module** - A quick fix for mounting the stationary end of an E-Chain® ▶ **page 9.16**

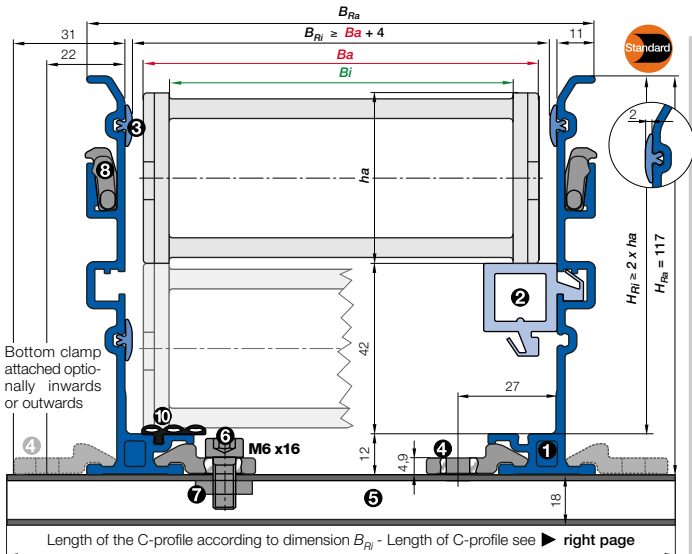

- **Components, trough "Basic":** ① Trough side parts, aluminum, 2 m ② Glide bar, plastic, 2 m ③ Glide strips, plastic, 2 m (without glide strips on request) ⑩ Optional: Silencer profile, rubber
- **Components, installation set "Basic":** ④ Bottom clamp, aluminum ⑤ C-profile, steel galvanized ⑥ Screw M6 x 16 ⑦ Sliding nut M6 ⑧ Interface connector, plastic

**Basic version: Aluminum "SuperTrough" components**

Complete guide trough sets - description	Part No.	Weight
① Set of 2 trough side parts, incl. glide strips, without glide bars, 2 m section	972.02.30.SL	= 6,00 kg
① Set of 2 trough side parts, incl. glide strips, with glide bars, 2 m section	972.02.31.SL	= 7,40 kg
1 Installation set "Basic" without C-profile	960.30.	= 0,06 kg
1 Installation set "Basic" with C-profile	960.30.	
Single parts - description		
③ 1 Glide strip, individual, 2 m section	75.01	= 0,06 kg
⑩ 1 Silencer profile, rubber, individual, 2 m section	75.67.H	
④ 1 Bottom clamp, individual	75.40	= 0,03 kg
⑧ 1 Interface connector, individual	75.60	
⑥ 1 Screw M6 x 16, individual	MAT 0040209	
⑦ 1 Sliding nut M6, individual	MAT 0040057	
② 1 Glide bar, individual, 2 m section	82.79	= 0,60 kg
⑤ 1 C-profile, individual	92.52.	= 0,90 kg/m



**Order example: Length of travel 30 m - Center mounted for Series E6.35.100.063.0 with  $B_{Ri} = 124$**

Guide trough set (set of 2 trough side parts, incl. glide strips) <b>without</b> glide bar	<b>Order text:</b> 16 m guide trough without glide bar (8 x 2 m sections)	<b>Part No.</b> 972.02.30.SL
Guide trough set (set of 2 trough side parts, incl. glide strips) <b>with</b> glide bar	<b>Order text:</b> 16 m guide trough with glide bar (8 x 2 m sections)	<b>Part No.</b> 972.02.31.SL
Installation set "Basic" complete (guide trough-sets + 1)	<b>Order text:</b> 17 installation sets "Basic"	<b>Part No.</b> 960.30.175
Module for the fixed end	<b>Order text:</b> 1 set	972.82
<b>Option:</b> For an additional noise dampening with silencer profile, please add Index A Example:		<b>Part No.</b> 972.02.30.SLA

Lengths of C-profile for Basic version - Bottom clamp attached optionally **inwards** or **outwards**

220			E6.35				
220.070.250.0			E6.35.100.063.0				
$B_{Rl}$ [mm]	Part No. attached inwards	Part No. attached outwards	$B_{Rl}$ [mm]	Part No. attached inwards	Part No. attached outwards		
.040	64	*	960.30.175	.040	54	*	960.30.150
.050	74	960.30.125	960.30.175	.050	64	*	960.30.175
.060	84	960.30.150	960.30.200	.060	74	960.30.125	960.30.175
.062	86	960.30.150	960.30.200	.062	84	960.30.150	960.30.200
.070	94	960.30.150	960.30.200	.070	94	960.30.150	960.30.200
.075	99	960.30.150	960.30.200	.075	104	960.30.150	960.30.200
.087	111	960.30.175	960.30.225	.087	114	960.30.175	960.30.225
.100	124	960.30.175	960.30.225	.100	124	960.30.175	960.30.225
.125	149	960.30.200	960.30.250	.125	134	960.30.200	960.30.250
.150	174	960.30.225	960.30.275	.150	144	960.30.200	960.30.250
.175	199	960.30.250	960.30.300				
.200	224	960.30.275	960.30.325				
.225	249	960.30.300	960.30.350				
.250	274	960.30.325	960.30.375				
.275	299	960.30.350	960.30.400				
.300	324	960.30.375	960.30.425				

\*upon request



Long travel length with the super-alu-trough in a cold store

"Heavy Duty" Version | Installation set Part No. 972.50

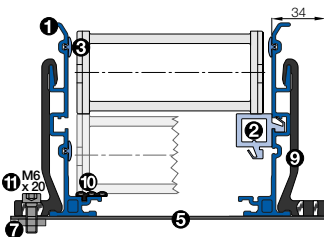

- **Components, trough "Heavy Duty":** ❶ Trough side parts, aluminum, 2 m ❷ Glide bar, plastic, 2 m ❸ Glide strips, plastic 2 m (without glide strips on request) ❹ Optional: Silencer profile, rubber
- **Components, installation set "Heavy Duty":** ❺ C-profile, steel galvanized ❻ Sliding nut M6 ❼ Heavy duty bracket, aluminum ❶ Screw M6 x 20

Note: Dimensions similar to Basic version!  
Exception: Heavy duty bracket, see drawing



- = Führungsrippen-Set
- = Gleitschiene
- = Montageset "Heavy duty"
- = C-Profil

Insert for the installation set "Heavy-Duty": **972.50.XXX** instead of 960.30.XXX on the right column "attached outwards"

"Heavy Duty" installation set Part No. 972.50. 150



For the following  
E-Chains®/E-Tubes:

**System E4 Series**

- 280/290/R770
- 2828/2928/R7728
- 28/29/R77 classic

**System E6 Series**

- E6.40/R6.40

$B_a$  = Outer E-Chain® width  
 $B_i$  = Inner E-Chain® width  
 $h_a$  = E-Chain® outer height  
 $H_{Ri}$  = Inner trough height  
 $H_{Ra}$  = Outer trough height  
 $B_{Ri}$  = Inner trough width  
 depends on dim.  $B_a$   
 $B_{Ra}$  = Outer trough width

!  $H_{Ri} \geq 2 \cdot h_a$   
 ■  $B_{Ri} \geq B_a + 4$

- = Guide trough
- = Glide bar
- = Installation set "Basic"
- = C-profile



**Calculation - travel center mounted**

Half travel length, rounded down to full 2 m sections =  $X$  m **guide trough length without glide bars** +  $X$  m **guide trough length with glide bars** + installation sets "Basic" (number of trough pieces + 1)

Supplement Part No. with the indicated C-profile-length-index.  
**Example:** 960.30.150  
 C-profile length-index for your chosen trough inner width  $B_{Ri}$ , see table on the right or the respective page for chosen series



**Fixed end module** - A quick fix for mounting the stationary end of an E-Chain® ▶ **page 9.16**

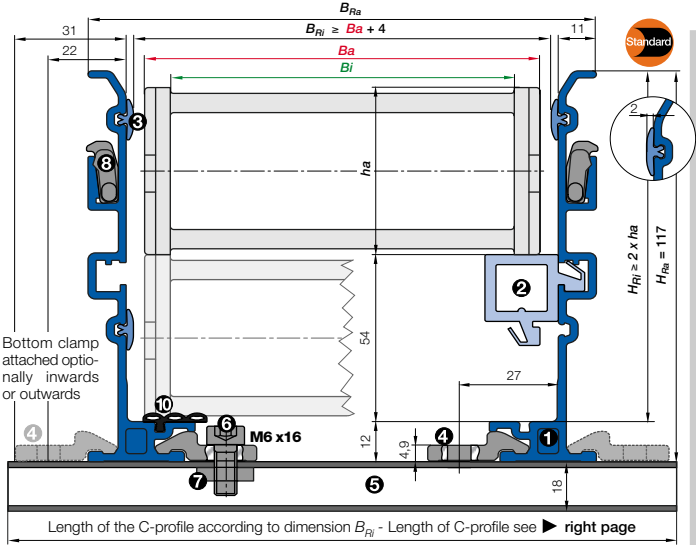

- **Components, trough "Basic":** ① Trough side parts, aluminum, 2 m ② Glide bar, plastic, 2 m ③ Glide strips, plastic, 2 m (without glide strips on request) ⑩ Optional: Silencer profile, rubber
- **Components, installation set "Basic":** ④ Bottom clamp, aluminum ⑤ C-profile, steel galvanized ⑥ Screw M6 x 16 ⑦ Sliding nut M6 ⑧ Interface connector, plastic

**Basic version: Aluminum "SuperTrough" components**

Complete guide trough sets - description	Part No.	Weight kg
① Set of 2 trough side parts, incl. glide strips, without glide bars, 2 m section	972.30.SL	≈ 6,00 kg
① Set of 2 trough side parts, incl. glide strips, with glide bars, 2 m section	972.31.SL	≈ 7,40 kg
1 Installation set "Basic" without C-profile	960.30	≈ 0,06 kg
1 Installation set "Basic" with C-profile	960.30. <input type="text"/>	
Single parts - description		
⑥ 1 Glide strip, individual, 2 m section	75.01	≈ 0,06 kg
⑩ 1 Silencer profile, rubber, individual, 2 m section	75.67.H	
④ 1 Bottom clamp, individual	75.40	≈ 0,03 kg
⑧ 1 Interface connector, individual	75.60	
⑥ 1 Screw M6 x 16, individual	MAT 0040209	
⑦ 1 Sliding nut M6, individual	MAT 0040057	
② 1 Glide bar, individual, 2 m section	82.79	≈ 0,60 kg
⑤ 1 C-profile, individual	92.52. <input type="text"/>	≈ 0,90 kg/m



**Order example: Length of travel 30 m - Center mounted for Series 280.07 with  $B_{Ri} = 102$**

Guide trough set (set of 2 trough side parts, incl. glide strips) <b>without</b> glide bar	<b>Order text:</b> 16 m guide trough without glide bar (8 x 2 m sections)	<b>Part No.</b>	972.30.SL
Guide trough set (set of 2 trough side parts, incl. glide strips) <b>with</b> glide bar	<b>Order text:</b> 16 m guide trough with glide bar (8 x 2 m sections)	<b>Part No.</b>	972.31.SL
Installation set "Basic" complete (guide trough-sets + 1)	<b>Order text:</b> 17 installation sets "Basic"	<b>Part No.</b>	960.30.150
Module for the fixed end	<b>Order text:</b> 1 set		972.80
<b>Option:</b> For an additional noise dampening with silencer profile, please add Index A Example:		<b>Part No.</b>	972.30.SLA

Lengths of C-profile for Basic version - Bottom clamp attached optionally inwards or outwards

280/290/R770				2828/2928/R7728				E6.40/R6.40			
280.05.200.0				2828.05.200.0				E6.40.040.063.0			
$B_{Ri}$ [mm]	Part No. attached inwards	Part No. attached outwards		$B_{Ri}$ [mm]	Part No. attached inwards	Part No. attached outwards		$B_{Ri}$ [mm]	Part No. attached inwards	Part No. attached outwards	
.05	77	960.30.125	960.30.175	.05	78	960.30.125	960.30.175	.040	64	*	960.30.175
.06	95	960.30.150	960.30.200	.06	96	960.30.150	960.30.200	.050	74	960.30.125	960.30.175
.07	102	960.30.150	960.30.200	.07	103	960.30.150	960.30.200	.062	86	960.30.150	960.30.200
.087	114	960.30.175	960.30.225	.087	115	960.30.175	960.30.225	.070	94	960.30.150	960.30.200
.10	127	960.30.175	960.30.225	.10	128	960.30.175	960.30.225	.075	99	960.30.150	960.30.200
.11	135	960.30.200	960.30.250	.11	136	960.30.200	960.30.225	.087	111	960.30.175	960.30.225
.112	140	960.30.200	960.30.250	.112	141	960.30.200	960.30.250	.100	124	960.30.175	960.30.225
.12	152	960.30.200	960.30.250	.12	153	960.30.200	960.30.250	.125	149	960.30.200	960.30.250
.137	165	960.30.225	960.30.275	.137	166	960.30.225	960.30.275	.150	174	960.30.225	960.30.275
.15	177	960.30.225	960.30.275	.15	178	960.30.225	960.30.275	.175	199	960.30.250	960.30.300
.162	190	960.30.250	960.30.300	.162	191	960.30.250	960.30.300	.200	224	960.30.275	960.30.325
.17	195	960.30.250	960.30.300	.17	196	960.30.250	960.30.300	.225	249	960.30.300	960.30.350
.18	202	960.30.250	960.30.300	.18	203	960.30.250	960.30.300	.250	274	960.30.325	960.30.375
.187	215	960.30.275	960.30.325	.187	216	960.30.275	960.30.325	.275	299	960.30.350	960.30.400
.20	227	960.30.275	960.30.325	.20	228	960.30.275	960.30.325	.300	324	960.30.375	960.30.425
.212	240	960.30.300	960.30.350	.212	241	960.30.300	960.30.350				
.23	252	960.30.300	960.30.350	.23	253	960.30.300	960.30.350				
.237	265	960.30.325	960.30.375	.237	266	960.30.325	960.30.375				
.25	277	960.30.325	960.30.375	.25	278	960.30.325	960.30.375				
.262	290	960.30.350	960.30.400	.262	291	960.30.350	960.30.400				
.28	302	960.30.350	960.30.400	.28	303	960.30.350	960.30.400				
.29	315	960.30.375	960.30.425	.29	316	960.30.375	960.30.425				
.30	327	960.30.375	960.30.425	.30	328	960.30.375	960.30.425				
.312	340	960.30.400	960.30.450	.312	341	960.30.400	960.30.450				
.325	352	960.30.400	960.30.450	.325	353	960.30.400	960.30.450				
.337	365	960.30.425	960.30.475	.337	366	960.30.425	960.30.475				
.350	377	960.30.425	960.30.475	.350	378	960.30.425	960.30.475				
.362	390	960.30.450	960.30.500	.362	391	960.30.450	960.30.500				
.375	402	960.30.450	960.30.500	.375	403	960.30.450	960.30.500				
.387	415	960.30.475	960.30.525	.387	416	960.30.475	960.30.525				
.400	427	960.30.475	960.30.525	.400	428	960.30.475	960.30.525				

\*upon request



igus® Series E4/4 with super-alu-trough in a crane application

"Heavy Duty" Version | Installation set Part No. 972.50

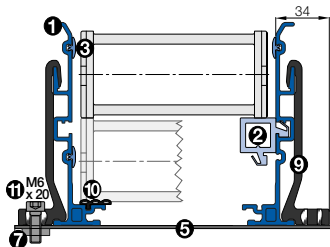

- Components, trough "Heavy Duty": ① Trough side parts, aluminum, 2 m ② Glide bar, plastic, 2 m ③ Glide strips, plastic 2 m (without glide strips on request) ⑩ Optional: Silencer profile, rubber
- Components, installation set "Heavy Duty": ⑤ C-profile, steel galvanized ⑦ Sliding nut M6 ⑧ Heavy duty bracket, aluminum ⑪ Screw M6 x 20

Note: Dimensions similar to Basic version!  
Exception: Heavy duty bracket, see drawing



- = Guide trough
- = Glide bar
- = Installation set "Heavy duty"
- = C-profile

Insert for the installation set "Heavy-Duty": **972.50.XXX** instead of 960.30.XXX on the right column "attached outwards"

"Heavy Duty" installation set Part No. 972.50. 150



For the following  
E-Chains®/E-Tubes:

**System E2 Series**

- 2600/2650/2680/2700
  - 26/27/27 classic
- System E2 E-Tubes**
- R58
  - R58 classic

$B_a$  = Outer E-Chain® width  
 $B_i$  = Inner E-Chain® width  
 $h_a$  = E-Chain® outer height  
 $H_{Ri}$  = Inner trough height  
 $H_{Ra}$  = Outer trough height  
 $B_{Ri}$  = Inner trough width  
 depends on dim.  $B_a$   
 $B_{Ra}$  = Outer trough width

!  $H_{Ri} \geq 2 \cdot h_a$   
 $B_{Ri} \geq B_a + 4$

- = Guide trough
- = Glide bar
- = Installation set "Basic"
- = C-profile



**Calculation - travel center mounted**

Half travel length, rounded down to full 2 m sections =  $X$  m **guide trough length without glide bars** +  $X$  m **guide trough length with glide bars** + installation sets "Basic" (number of trough pieces + 1)

Supplement Part No. with the indicated C-profile-length-index.  
**Example : 960.30.150**  
 C-profile length-index for your chosen trough inner width  $B_{Ri}$  ▶ see table on the right or the respective page for chosen series



**Fixed end module** - A quick fix for mounting the stationary end of an E-Chain® ▶ **page 9.16**

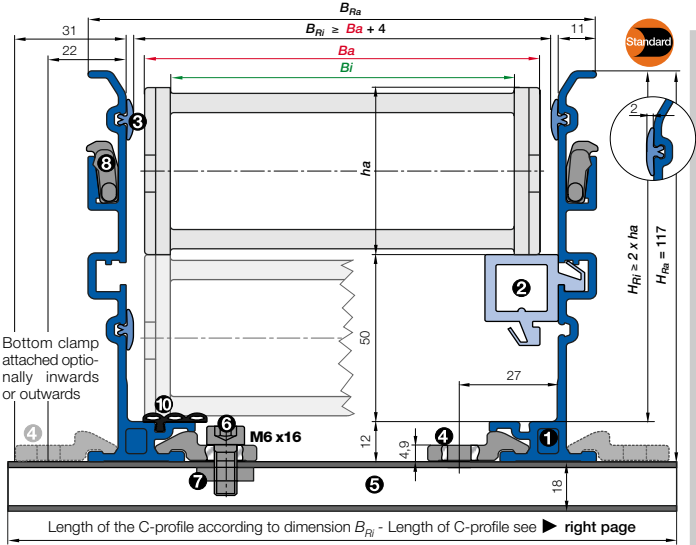

- **Components, trough "Basic":** ① Trough side parts, aluminum, 2 m ② Glide bar, plastic, 2 m ③ Glide strips, plastic, 2 m (without glide strips on request) ⑩ Optional: Silencer profile, rubber
- **Components, installation set "Basic":** ④ Bottom clamp, aluminum ⑤ C-profile, steel galvanized ⑥ Screw M6 x 16 ⑦ Sliding nut M6 ⑧ Interface connector, plastic

**Basic version: Aluminum "SuperTrough" components**

Complete guide trough sets - description	Part No.	Weight
① Set of 2 trough side parts, incl. glide strips, without glide bars, 2 m section	972.30.SL	≈ 6,00 kg
① Set of 2 trough side parts, incl. glide strips, with glide bars, 2 m section	972.32.SL	≈ 7,40 kg
1 Installation set "Basic" without C-profile	960.30	≈ 0,06 kg
1 Installation set "Basic" with C-profile	960.30. <input type="text"/>	
Single parts - description		
③ 1 Glide strip, individual, 2 m section	75.01	≈ 0,06 kg
⑩ 1 Silencer profile, rubber, individual, 2 m section	75.67.H	
④ 1 Bottom clamp, individual	75.40	≈ 0,03 kg
⑧ 1 Interface connector, individual	75.60	
⑥ 1 Screw M6 x 16, individual	MAT 0040209	
⑦ 1 Sliding nut M6, individual	MAT 0040057	
② 1 Glide bar, individual, 2 m section	82.79	≈ 0,60 kg
⑤ 1 C-profile, individual	92.52. <input type="text"/>	≈ 0,90 kg/m



**Order example: Length of travel 30 m - Center mounted for Series 2600.07 with  $B_{Ri} = 95$**

Guide trough set (set of 2 trough side parts, incl. glide strips) <b>without</b> glide bar	<b>Order text: 16 m guide trough without glide bar (8 x 2 m sections)</b>	<b>Part No.</b>	<b>972.30.SL</b>
Guide trough set (set of 2 trough side parts, incl. glide strips) <b>with</b> glide bar	<b>Order text: 16 m guide trough with glide bar (8 x 2 m sections)</b>	<b>Part No.</b>	<b>972.32.SL</b>
Installation set "Basic" complete (guide trough-sets + 1)	<b>Order text: 17 installation sets "Basic"</b>	<b>Part No.</b>	<b>960.30.150</b>
Module for the fixed end	<b>Order text: 1 set</b>		<b>972.81</b>
<b>Option:</b> For an additional noise dampening with silencer profile, please add Index A Example:		<b>Part No.</b>	<b>972.30.SLA</b>



Lengths of C-profile for Basic version - Bottom clamp attached optionally **inwards** or **outwards**

2600/2650/2680/2700				R58			
2600.05.200.0				58.075.200.0			
$B_{Rl}$ [mm]	Part No. attached inwards	Part No. attached outwards	$B_{Rl}$ [mm]	Part No. attached inwards	Part No. attached outwards		
.05	70	*	960.30.175	.050	70	*	960.30.175
.06	85	960.30.150	960.30.200	.075	95	960.30.150	960.30.200
.07	95	960.30.150	960.30.200	.100	120	960.30.175	960.30.225
.09	110	960.30.175	960.30.225	.125	145	960.30.200	960.30.250
.10	120	960.30.175	960.30.225	.150	170	960.30.225	960.30.275
.12	145	960.30.200	960.30.250	.175	195	960.30.250	960.30.300
.15	170	960.30.225	960.30.275	.200	220	960.30.275	960.30.325
.17	198	960.30.250	960.30.300				

\*upon request



Stable guidance without oscillation. Crane operating speed 80 m/min.

"Heavy Duty" Version | Installation set Part No. Nr. 972.50

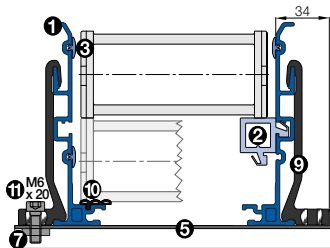

- **Components, trough "Heavy Duty":** ❶ Trough side parts, aluminum, 2 m ❷ Glide bar, plastic, 2 m ❸ Glide strips, plastic 2 m (without glide strips on request) ❹ Optional: Silencer profile, rubber
- **Components, installation set "Heavy Duty":** ❺ C-profile, steel galvanized ❻ Sliding nut M6 ❼ Heavy duty bracket, aluminum ❶ Screw M6 x 20



- = Guide trough
- = Glide bar
- = Installation set "Heavy duty"
- = C-profile

Note: Dimensions similar to Basic version!  
Exception: Heavy duty bracket, see drawing



Insert for the installation set "Heavy-Duty": **972.50.XXX** instead of 960.30.XXX on the right column "attached outwards"

"Heavy Duty" installation set Part No. 972.50. 150



For the following  
E-Chains®/E-Tubes:

**System E2 Series**

- 3400/3450/3480/3500

- 340/350 classic

**System E2 E-Tubes Series**

- R68 ● R68 classic

**System E4 Series**

- 380/390/R780

- 3838/3938/R7838

- 38/39/R78 classic

**System E6 Series**

- E6.52/R6.52

$B_a$  = Outer E-Chain® width

$B_i$  = Inner E-Chain® width

$h_a$  = E-Chain® outer height

$H_{Ri}$  = Inner trough height

$H_{Ra}$  = Outer trough height

$B_{Ri}$  = Inner trough width ►  
depends on dim.  $B_a$

$B_{Ra}$  = Outer trough width

!  $H_{Ri} \geq 2 \cdot h_a$   
■  $B_{Ri} \geq B_a + 4$

● = Guide trough

● = Glide bar

● = Installation set "Basic"

● = C-profile



**Calculation - travel  
center mounted**

Half travel length, rounded down to full 2 m sections =  $X$  m **guide trough length without glide bars** +  $X$  m **guide trough length with glide bars** + installation sets "Basic" (number of trough pieces + 1)

Supplement Part No. with the indicated C-profile-length-index.

**Example:** 960.40.175

C-profile length-index for your chosen trough inner width  $B_{Ri}$  ► see table on the right or the respective page for chosen series



**Fixed end module** - A quick fix for mounting the stationary end of an E-Chain® ► **page 9.16**

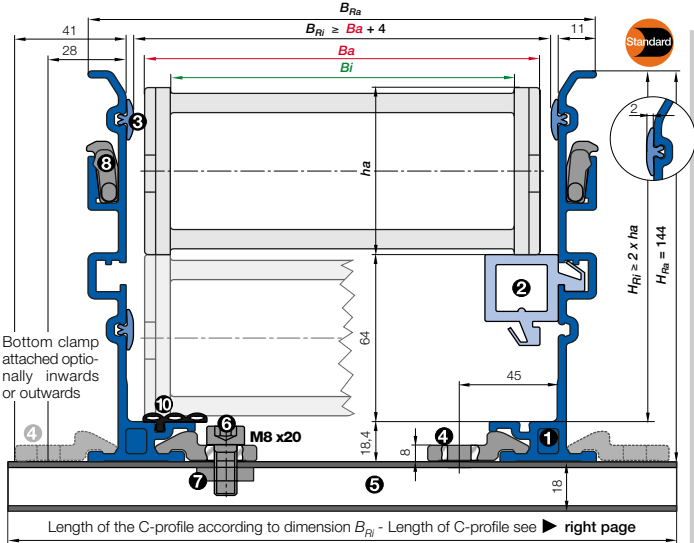

- **Components, trough "Basic":** ① Trough side parts, aluminum, 2 m ② Glide bar, plastic, 2 m ③ Glide strips, plastic, 2 m (without glide strips on request) ⑩ Optional: Silencer profile, rubber
- **Components, installation set "Basic":** ④ Bottom clamp, aluminum ⑤ C-profile, steel galvanized ⑥ Screw M8 x 20 ⑦ Sliding nut M8 ⑧ Interface connector, plastic

**Basic version: Aluminum "SuperTrough" components**

**Complete guide trough sets - description**

	Part No.	Weight kg
① Set of 2 trough side parts, incl. glide strips, without glide bars, 2 m section	973.30.SL	≈ 8,00 kg
① Set of 2 trough side parts, incl. glide strips, with glide bars, 2 m section	973.31.SL	≈ 10,8 kg
1 Installation set "Basic" without C-profile	960.40.	≈ 0,08 kg
1 Installation set "Basic" with C-profile	960.40.	

**Single parts - description**

② 1 Glide strip, individual, 2 m section	75.01	≈ 0,06 kg
⑩ 1 Silencer profile, rubber, individual, 2 m section	75.68.H	
④ 1 Bottom clamp, individual	75.50	≈ 0,04 kg
⑧ 1 Interface connector, individual	75.60	
⑥ 1 Screw M8 x 20, individual	MAT 0040445	
⑦ 1 Sliding nut M8, individual	MAT 0040413	
② 1 Glide bar, individual, 2 m section	83.79	≈ 1,30 kg
⑤ 1 C-profile, individual	92.52.	≈ 0,90 kg/m



**Order example: Length of travel 30 m -  
Center mounted for Series 3400.100 with  $B_{Ri} = 124$**

Guide trough set (set of 2 trough side parts, incl. glide strips) <b>without</b> glide bar		
<b>Order text:</b> 16 m guide trough without glide bar (8 x 2 m sections)	<b>Part No.</b>	973.30.SL
Guide trough set (set of 2 trough side parts, incl. glide strips) <b>with</b> glide bar		
<b>Order text:</b> 16 m guide trough with glide bar (8 x 2 m sections)	<b>Part No.</b>	973.31.SL
Installation set "Basic" complete (guide trough-sets + 1)		
<b>Order text:</b> 17 installation sets "Basic"	<b>Part No.</b>	960.40.175
Module for the fixed end		
<b>Order text:</b> 1 set		973.80
<b>Option:</b> For an additional noise dampening with silencer profile, please add Index A Example:	<b>Part No.</b>	973.30.SLA

Lengths of C-profile for Basic version - Bottom clamp attached optionally inwards or outwards

3400/3450/3480/3500			R68			380/390/R780			3838/3938/R7838			E6.52/R6.52			
3400.050.200.0			68.050.200.0			380.05.200.0			3838.05.200.0			E6.52.040.200.0			
$B_{Rl}$ [mm]	Part No. attached inwards	Part No. attached outwards	$B_{Rl}$ [mm]	Part No. attached inwards	Part No. attached outwards	$B_{Rl}$ [mm]	Part No. attached inwards	Part No. attached outwards	$B_{Rl}$ [mm]	Part No. attached inwards	Part No. attached outwards	$B_{Rl}$ [mm]	Part No. attached inwards	Part No. attached outwards	
.050	74	*	960.40.200	.050	72	*	960.40.200	.05	80	*	960.40.200	.05	81	*	960.40.200
.075	99	*	960.40.225	.075	97	*	960.40.225	.06	98	*	960.40.225	.06	99	*	960.40.225
.100	124	960.40.175	960.40.250	.100	122	960.40.175	960.40.250	.07	105	*	960.40.225	.07	106	*	960.40.225
.115	139	960.40.200	960.40.275	.115	137	960.40.200	960.40.275	.087	118	960.40.175	960.40.250	.087	119	960.40.175	960.40.250
.125	149	960.40.200	960.40.275	.125	147	960.40.200	960.40.275	.10	130	960.40.200	960.40.250	.10	131	960.40.200	960.40.250
.150	174	960.40.225	960.40.300	.150	172	960.40.225	960.40.300	.11	138	960.40.200	960.40.275	.11	139	960.40.200	960.40.275
.175	199	960.40.250	960.40.325	.175	197	960.40.250	960.40.325	.112	143	960.40.200	960.40.275	.112	144	960.40.200	960.40.275
.200	224	960.40.275	960.40.350	.200	222	960.40.275	960.40.350	.12	155	960.40.225	960.40.275	.12	156	960.40.225	960.40.275
.225	249	960.40.300	960.40.375	.225	247	960.40.300	960.40.375	.137	168	960.40.225	960.40.300	.137	169	960.40.225	960.40.300
.250	274	960.40.325	960.40.400	.250	272	960.40.325	960.40.400	.15	180	960.40.250	960.40.300	.15	181	960.40.250	960.40.300
								.162	193	960.40.250	960.40.325	.162	194	960.40.250	960.40.325
								.17	198	960.40.250	960.40.325	.17	199	960.40.250	960.40.325
								.18	205	960.40.275	960.40.325	.18	206	960.40.275	960.40.325
								.187	218	960.40.275	960.40.350	.187	219	960.40.275	960.40.350
								.20	230	960.40.300	960.40.350	.20	231	960.40.300	960.40.350
								.212	243	960.40.300	960.40.375	.212	244	960.40.300	960.40.375
								.23	255	960.40.325	960.40.375	.23	256	960.40.325	960.40.375
								.237	268	960.40.325	960.40.400	.237	269	960.40.325	960.40.400
								.25	280	960.40.350	960.40.400	.25	281	960.40.350	960.40.400
								.262	293	960.40.350	960.40.425	.262	294	960.40.350	960.40.425
								.28	305	960.40.375	960.40.425	.28	306	960.40.375	960.40.425
								.29	318	960.40.375	960.40.450	.29	319	960.40.375	960.40.450
								.30	330	960.40.400	960.40.450	.30	331	960.40.400	960.40.450
								.312	343	960.40.400	960.40.475	.312	344	960.40.400	960.40.475
								.325	355	960.40.425	960.40.475	.325	356	960.40.425	960.40.475
								.337	368	960.40.425	960.40.500	.337	369	960.40.425	960.40.500
								.350	380	960.40.450	960.40.500	.350	381	960.40.450	960.40.500
								.362	393	960.40.450	960.40.525	.362	394	960.40.450	960.40.525
								.375	406	960.40.475	960.40.525	.375	406	960.40.475	960.40.525
								.387	418	960.40.475	960.40.550	.387	419	960.40.475	960.40.550
								.400	430	960.40.500	960.40.550	.400	431	960.40.500	960.40.550

\*upon request

"Heavy Duty" Version | Installation set Part No. 973.50

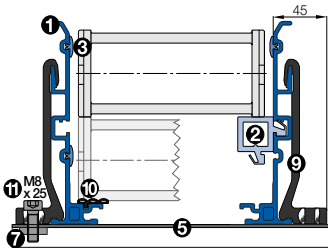

- Components, trough "Heavy Duty": ① Trough side parts, aluminum, 2 m ② Glide bar, plastic, 2 m ③ Glide strips, plastic 2 m (without glide strips on request) ⑩ Optional: Silencer profile, rubber
- Components, installation set "Heavy Duty": ⑤ C-profile, steel galvanized ⑦ Sliding nut M8 ⑧ Heavy duty bracket, aluminum ⑨ Screw M8 x 25



- = Guide trough
- = Glide bar
- = Installation set "Heavy duty"
- = C-profile

Note: Dimensions similar to Basic version!  
Exception: Heavy duty bracket, see drawing

Insert for the installation set "Heavy-Duty": **973.50.XXX** instead of 960.40.XXX on the right column "attached outwards"  
"Heavy Duty" installation set Part No 973.50.175



For the following  
E-Chains®/E-Tubes:

**System E4 Series**

- 400/410/R880
- 4040/4140/R8840
- 140/141/R188 classic
- 142/143 classic
- 14040/14140/R18840
- 14240/14340
- 40/41/R88 classic

**System E6 Series**

- E6.62

$B_a$  = Outer E-Chain® width  
 $B_i$  = Inner E-Chain® width  
 $h_a$  = E-Chain® outer height  
 $H_{Ri}$  = Inner trough height  
 $H_{Ra}$  = Outer trough height  
 $B_{Ri}$  = Inner trough width  
 depends on dim.  $B_a$   
 $B_{Ra}$  = Outer trough width

!  $H_{Ri} \geq 2 \cdot h_a$   
 ■  $B_{Ri} \geq B_a + 4$

- = Guide trough
- = Glide bar
- = Installation set "Basic"
- = C-profile



**Calculation - travel center mounted**

Half travel length, rounded down to full 2 m sections =  $X$  m **guide trough length without glide bars** +  $X$  m **guide trough length with glide bars** + installation sets "Basic" (number of trough pieces + 1)

Supplement Part No. with the indicated C-profile-length-index.  
**Example:** 960.50.200  
 C-profile length-index for your chosen trough inner width  $B_{Ri}$  ▶ see table on the right or the respective page for chosen series



**Fixed end module** - A quick fix for mounting the stationary end of an E-Chain® ▶ **page 9.16**

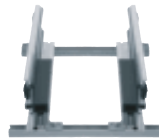
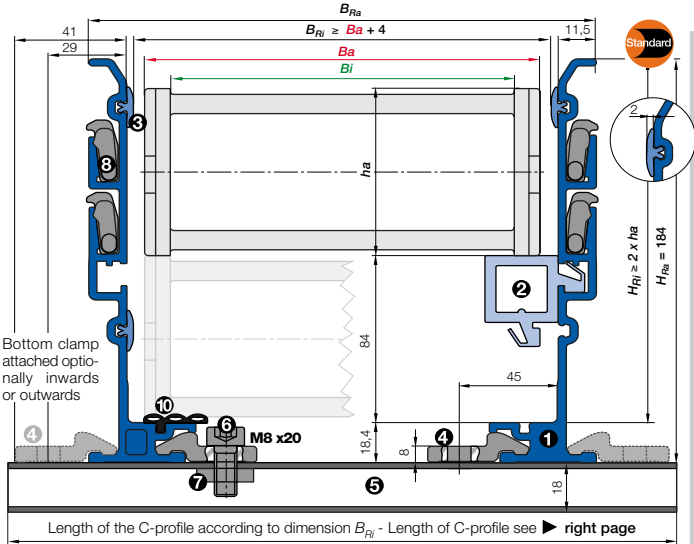

- **Components, trough "Basic":** ① Trough side parts, aluminum, 2 m ② Glide bar, plastic, 2 m ③ Glide strips, plastic, 2 m (without glide strips on request) ⑩ Optional: Silencer profile, rubber
- **Components, installation set "Basic":** ④ Bottom clamp, aluminum ⑤ C-profile, steel galvanized ⑥ Screw M8 x 20 ⑦ Sliding nut M8 ⑧ Interface connector, plastic

**Basic version: Aluminum "SuperTrough" components**

Complete guide trough sets - description	Part No.	Weight	kg
① Set of 2 trough side parts, incl. glide strips, without glide bars, 2 m section	974.30.SL	≈ 10,0 kg	
① Set of 2 trough side parts, incl. glide strips, with glide bars, 2 m section	974.31.SL	≈ 12,8 kg	
1 Installation set "Basic" without C-profile	960.50	≈ 0,08 kg	
1 Installation set "Basic" with C-profile	960.50.		
Single parts - description			
⑥ 1 Glide strip, individual, 2 m section	75.01	≈ 0,06 kg	
⑩ 1 Silencer profile, rubber, individual, 2 m section	75.68.H		
④ 1 Bottom clamp, individual	75.50	≈ 0,04 kg	
⑧ 1 Interface connector, individual	75.60		
⑥ 1 Screw M8 x 20, individual	MAT 0040445		
⑦ 1 Sliding nut M8, individual	MAT 0040413		
② 1 Glide bar, individual, 2 m section	83.79	≈ 1,30 kg	
⑤ 1 C-profile, individual	92.52.	≈ 0,90 kg/m	



**Order example: Length of travel 30 m - Center mounted for Series 400.10 with  $B_{Ri} = 138$**

Guide trough set (set of 2 trough side parts, incl. glide strips) <b>without</b> glide bar	<b>Order text:</b> 16 m guide trough without glide bar (8 x 2 m sections)	<b>Part No.</b>	974.30.SL
Guide trough set (set of 2 trough side parts, incl. glide strips) <b>with</b> glide bar	<b>Order text:</b> 16 m guide trough with glide bar (8 x 2 m sections)	<b>Part No.</b>	974.31.SL
Installation set "Basic" complete (guide trough-sets + 1)	<b>Order text:</b> 17 installation sets "Basic"	<b>Part No.</b>	960.50.200
Module for the fixed end	<b>Order text:</b> 1 set		974.80
<b>Option:</b> For an additional noise dampening with silencer profile, please add Index A Example:		<b>Part No.</b>	974.30.SLA

## Lengths of C-profile for Basic version - Bottom clamp attached optionally inwards or outwards

400/410/R880			4040/4140/R8840			14040/14140/R18840			14240/14340			E6.62		
400.05.200.0			4040.05.200.0			14040.05.200.0			14240.05.200.0			E6.62.05.200.0		
$B_{Rl}$ [mm]	Part No. attached inwards	Part No. attached outwards	$B_{Rl}$ [mm]	Part No. attached inwards	Part No. attached outwards	$B_{Rl}$ [mm]	Part No. attached inwards	Part No. attached outwards	$B_{Rl}$ [mm]	Part No. attached inwards	Part No. attached outwards	$B_{Rl}$ [mm]	Part No. attached inwards	Part No. attached outwards
.05	88	* 960.50.225	.05	90	* 960.50.225	.05	80	* 960.50.200	.05	80	* 960.50.200	.05	90	* 960.50.225
.06	103	* 960.50.225	.06	105	* 960.50.225	.06	95	* 960.50.225	.06	98	* 960.50.225	.06	108	* 960.50.225
.07	113	* 960.50.250	.07	115	* 960.50.250	.07	105	* 960.50.225	.07	105	* 960.50.225	.07	115	* 960.50.250
.10	138	960.50.200 960.50.275	.10	140	960.50.200 960.50.275	.10	130	960.50.200 960.50.250	.087	118	960.50.175 960.50.250	.087	127	960.50.175 960.50.250
.11	151	960.50.200 960.50.275	.11	153	960.50.200 960.50.275	.11	143	960.50.200 960.50.275	.10	130	960.50.200 960.50.250	.10	140	960.50.200 960.50.275
.12	163	960.50.225 960.50.300	.12	165	960.50.225 960.50.300	.12	155	960.50.225 960.50.275	.11	138	960.50.200 960.50.275	.11	148	960.50.200 960.50.275
.13	176	960.50.225 960.50.300	.13	178	960.50.225 960.50.300	.13	168	960.50.225 960.50.300	.112	143	960.50.200 960.50.275	.112	152	960.50.200 960.50.275
.15	188	960.50.250 960.50.325	.15	190	960.50.250 960.50.325	.15	180	960.50.250 960.50.300	.12	155	960.50.225 960.50.275	.12	165	960.50.225 960.50.300
.16	201	960.50.250 960.50.325	.16	203	960.50.250 960.50.325	.16	193	960.50.250 960.50.325	.137	168	960.50.225 960.50.300	.137	177	960.50.225 960.50.300
.17	213	960.50.275 960.50.350	.17	215	960.50.275 960.50.350	.17	205	960.50.275 960.50.325	.15	180	960.50.250 960.50.300	.15	190	960.50.250 960.50.325
.18	226	960.50.275 960.50.350	.18	228	960.50.275 960.50.350	.18	218	960.50.275 960.50.350	.162	193	960.50.250 960.50.325	.162	202	960.50.250 960.50.325
.20	238	960.50.300 960.50.375	.20	240	960.50.300 960.50.375	.20	230	960.50.300 960.50.350	.17	198	960.50.250 960.50.325	.17	208	960.50.275 960.50.325
.21	251	960.50.300 960.50.375	.21	253	960.50.300 960.50.375	.21	243	960.50.300 960.50.375	.18	205	960.50.275 960.50.325	.18	215	960.50.275 960.50.350
.22	263	960.50.325 960.50.400	.22	265	960.50.325 960.50.400	.22	255	960.50.325 960.50.400	.187	218	960.50.275 960.50.350	.187	227	960.50.275 960.50.350
.23	276	960.50.325 960.50.400	.23	278	960.50.325 960.50.400	.23	268	960.50.325 960.50.400	.20	230	960.50.300 960.50.350	.20	240	960.50.300 960.50.375
.25	288	960.50.350 960.50.425	.25	290	960.50.350 960.50.425	.25	280	960.50.350 960.50.400	.212	243	960.50.300 960.50.375	.212	252	960.50.300 960.50.375
.26	301	960.50.350 960.50.425	.26	303	960.50.350 960.50.425	.26	293	960.50.350 960.50.425	.23	255	960.50.325 960.50.375	.23	265	960.50.325 960.50.400
.27	313	960.50.375 960.50.450	.27	315	960.50.375 960.50.450	.27	305	960.50.375 960.50.425	.237	268	960.50.325 960.50.400	.237	277	960.50.325 960.50.400
.28	326	960.50.375 960.50.450	.28	328	960.50.375 960.50.450	.28	318	960.50.375 960.50.450	.25	280	960.50.350 960.50.400	.25	290	960.50.350 960.50.425
.30	338	960.50.400 960.50.475	.30	340	960.50.400 960.50.475	.30	330	960.50.400 960.50.450	.262	293	960.50.350 960.50.425	.262	302	960.50.350 960.50.425
.31	351	960.50.400 960.50.475	.31	353	960.50.400 960.50.475	.31	343	960.50.400 960.50.475	.28	305	960.50.375 960.50.425	.28	315	960.50.375 960.50.450
.32	363	960.50.425 960.50.500	.32	365	960.50.425 960.50.500	.32	355	960.50.425 960.50.475	.29	318	960.50.375 960.50.450	.29	327	960.50.375 960.50.450
.33	376	960.50.425 960.50.500	.33	378	960.50.425 960.50.500	.33	368	960.50.425 960.50.500	.30	330	960.50.400 960.50.450	.30	340	960.50.400 960.50.475
.35	388	960.50.450 960.50.525	.35	390	960.50.450 960.50.525	.35	380	960.50.450 960.50.500	.312	343	960.50.400 960.50.475	.312	352	960.50.400 960.50.475
.36	401	960.50.450 960.50.525	.36	403	960.50.450 960.50.525	.36	393	960.50.450 960.50.525	.325	355	960.50.425 960.50.475	.325	365	960.50.425 960.50.500
.37	413	960.50.475 960.50.550	.37	415	960.50.475 960.50.550	.37	405	960.50.475 960.50.525	.337	368	960.50.425 960.50.500	.337	377	960.50.425 960.50.500
.38	426	960.50.475 960.50.550	.38	428	960.50.475 960.50.550	.38	418	960.50.475 960.50.550	.350	380	960.50.450 960.50.500	.350	390	960.50.450 960.50.525
.40	438	960.50.500 960.50.575	.40	440	960.50.500 960.50.575	.40	430	960.50.500 960.50.550	.362	393	960.50.450 960.50.525	.362	402	960.50.450 960.50.525
.41	451	960.50.500 960.50.575	.41	453	960.50.500 960.50.575	.41	443	960.50.500 960.50.575	.375	405	960.50.475 960.50.525	.375	415	960.50.475 960.50.550
.42	463	960.50.525 960.50.600	.42	465	960.50.525 960.50.600	.42	455	960.50.525 960.50.575	.387	418	960.50.475 960.50.550	.387	427	960.50.475 960.50.550
.43	476	960.50.525 960.50.600	.43	478	960.50.525 960.50.600	.43	468	960.50.525 960.50.600	.400	430	960.50.500 960.50.550	.400	440	960.50.500 960.50.575
.45	488	960.50.550 960.50.625	.45	490	960.50.550 960.50.625	.45	480	960.50.550 960.50.600						* upon request
.46	501	960.50.550 960.50.625	.46	503	960.50.550 960.50.625	.46	493	960.50.550 960.50.625						
.47	513	960.50.575 960.50.650	.47	515	960.50.575 960.50.650	.47	505	960.50.575 960.50.625						
.48	526	960.50.575 960.50.650	.48	528	960.50.575 960.50.650	.48	518	960.50.575 960.50.650						
.50	538	960.50.600 960.50.675	.50	540	960.50.600 960.50.675	.50	530	960.50.600 960.50.650						
.51	551	960.50.600 960.50.675	.51	553	960.50.600 960.50.675	.51	543	960.50.600 960.50.675						
.52	563	960.50.625 960.50.700	.52	565	960.50.625 960.50.700	.52	555	960.50.625 960.50.675						
.53	576	960.50.625 960.50.700	.53	578	960.50.625 960.50.700	.53	568	960.50.625 960.50.700						
.55	588	960.50.650 960.50.725	.55	590	960.50.650 960.50.725	.55	580	960.50.650 960.50.700						
.60	638	960.50.700 960.50.775	.60	640	960.50.700 960.50.775	.60	630	960.50.700 960.50.750						

## "Heavy Duty" Version | Installation set Part No. 974.50

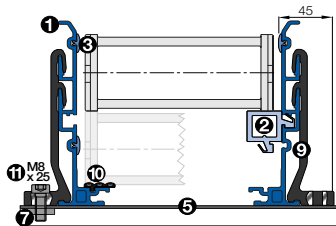

- Components, trough "Heavy Duty": ① Trough side parts, aluminum, 2 m ② Glide bar, plastic, 2 m ③ Glide strips, plastic 2 m (without glide strips on request) ⑩ Optional: Silencer profile, rubber

- Components, installation set "Heavy Duty": ⑤ C-profile, steel galvanized ⑦ Sliding nut M8 ⑧ Heavy duty bracket, aluminum ⑪ Screw M8 x 25

Note: Dimensions similar to Basic version!  
Exception: Heavy duty bracket, see drawing



- = Guide trough
- = Glide bar
- = Installation set "Heavy duty"
- = C-profile

Insert for the installation set "Heavy-Duty": **974.50.XXX** instead of 960.50.XXX on the right column "attached outwards"  
"Heavy Duty" installation set Part No. 974.50. 200



For the following  
E-Chains®/E-Tubes:

**System E4 Series**

- 4040HD/R8840HD

We especially recommend for the igus® E4/4 series 4040 HD (Heavy Duty) this trough system. Structurally identical with trough 974.30.SL yet with special HD-installation set, suitable for ambitious applications.

- $B_a$  = Outer E-Chain width
- $B_i$  = Inner E-Chain width
- $h_a$  = E-Chain® outer height
- $H_{Ri}$  = Inner trough height
- $H_{Ra}$  = Outer trough height
- $B_{Ri}$  = Inner trough width ▶ depends on dim.  $B_a$
- $B_{Ra}$  = Outer trough width

!  $H_{Ri} \geq 2 \cdot h_a$   
■  $B_{Ri} \geq B_a + 4$

- = Guide trough
- = Glide bar
- = Installation set "Basic"
- = C-profile



**Calculation - travel center mounted**

Half travel length, rounded down to full 2 m sections =  $X$  m **guide trough length without glide bars** +  $X$  m **guide trough length with glide bars** + installation sets "Basic" (number of trough pieces + 1)

Supplement Part No. with the indicated C-profile-length-index.

**Example:** 974.50.200

C-profile length-index for your chosen trough inner width  $B_{Ri}$  ▶ see table on the right or the respective page for chosen series



**Fixed end module** - A quick fix for mounting the stationary end of an E-Chain® ▶ **page 9.16**

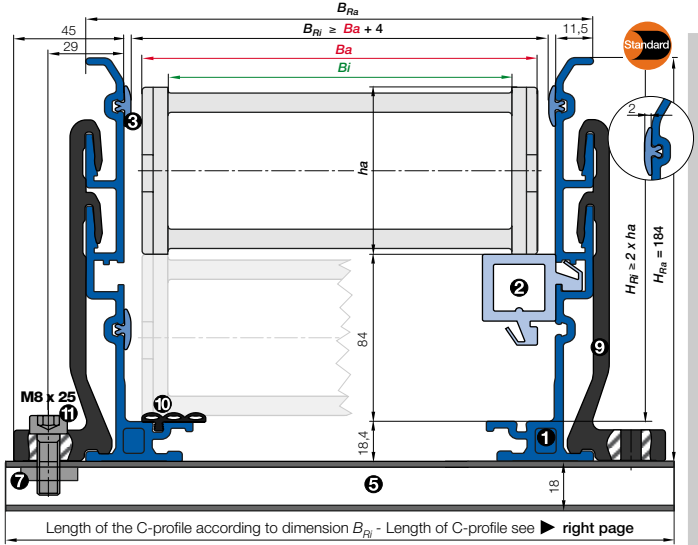

- **Components, trough "Heavy Duty":** ① Trough side parts, aluminum, 2 m ② Glide bar, plastic, 2 m ③ Glide strips, plastic, 2 m (without glide strips on request) ⑩ Optional: Silencer profile, rubber ● **Components, installation set "Heavy Duty":** ⑤ C-profile, steel galvanized ⑦ Sliding nut M8 ⑨ Heavy duty bracket, aluminum ⑪ Screw M8 x 25

**Heavy Duty version: Aluminum "SuperTrough" components**

Complete guide trough sets - description	Part No.	Weight kg
① Set of 2 trough side parts, incl. glide strips, without glide bars, 2 m section	974.30.SL	≈ 10,0 kg
① Set of 2 trough side parts, incl. glide strips, with glide bars, 2 m section	974.31.SL	≈ 12,8 kg
1 Installation set "Heavy Duty" without C-profile	974.50	≈ 0,40 kg
1 Installation set "Heavy Duty" with C-profile	974.50. <input type="text"/>	
Single parts - description		
③ 1 Glide strip, individual, 2 m section	75.01	≈ 0,06 kg
⑩ 1 Silencer profile, rubber, individual, 2 m section	75.68.H	
⑪ 1 Screw M8 x 25, individual	MAT 0040445	
⑦ 1 Sliding nut M8, individual	MAT 0040413	
② 1 Glide bar, individual, 2 m section	83.79	≈ 1,30 kg
⑤ 1 C-profile, individual	92.52. <input type="text"/>	≈ 0,90 kg/m



**Order example: Length of travel 30 m - Center mounted for Series 4040HD.10.250.0 with  $B_{Ri} = 158$**

Guide trough set (set of 2 trough side parts, incl. glide strips) <b>without</b> glide bar	<b>Order text:</b> 16 m guide trough without glide bar (8 x 2 m sections)	<b>Part No.</b>	974.30.SL
Guide trough set (set of 2 trough side parts, incl. glide strips) <b>with</b> glide bar	<b>Order text:</b> 16 m guide trough with glide bar (8 x 2 m sections)	<b>Part No.</b>	974.31.SL
Installation set "Heavy Duty" complete (guide trough-sets + 1)	<b>Order text:</b> 17 installation sets "Heavy Duty"	<b>Part No.</b>	974.50.275
Module for the fixed end	<b>Order text:</b> 1 set		974.80
<b>Option:</b> For an additional noise dampening with silencer profile, please add Index A Example:		<b>Part No.</b>	974.30.SLA

Lengths of C-profile

4040HD/R8840HD

4040HD.05.250.0

$B_{R1}$ [mm]	Part No. assembled
.05 108	974.50.225
.06 123	974.50.250
.07 133	974.50.250
.10 158	974.50.275
.11 170	974.50.300
.12 183	974.50.300
.13 195	974.50.325
.15 208	974.50.325
.16 220	974.50.350
.17 233	974.50.350
.18 245	974.50.375
.20 258	974.50.375
.21 270	974.50.400
.22 283	974.50.400
.23 295	974.50.425
.25 308	974.50.425
.26 320	974.50.450
.27 333	974.50.450
.28 345	974.50.475
.30 358	974.50.475
.31 370	974.50.500
.32 383	974.50.500
.33 395	974.50.525
.35 408	974.50.525
.36 420	974.50.550
.37 433	974.50.550
.38 445	974.50.575
.40 458	974.50.575
.41 470	974.50.600
.42 483	974.50.600
.43 495	974.50.625
.45 508	974.50.625
.46 520	974.50.650
.47 533	974.50.650
.48 545	974.50.675
.50.^ 558	974.50.675
.51 570	974.50.700
.52 583	974.50.700
.53 595	974.50.725
.55 608	974.50.725
.60 658	974.50.775

# Series 4040HD Heavy-Duty

**For long travels and high fill weights**

Compared to the standard 4040: ● Higher tensile strength ● Times larger support areas at the stop dogs  
● Increased side wall thickness ● Support area at pin increased ● Application examples: Cranes, composting plants, concrete plants, mining

**Series 4040HD ► from page 7.128**







For the following  
E-Chains®/E-Tubes:

**System E4 Series**

- 5050/5150/R9850
- 15050/15150/R19850

**System E6 Series**

- E6.80L
- E6.80

$B_a$  = Outer E-Chain® width  
 $B_i$  = Inner E-Chain® width  
 $h_a$  = E-Chain® outer height  
 $H_{Ri}$  = Inner trough height  
 $H_{Ra}$  = Outer trough height  
 $B_{Ri}$  = Inner trough width ►  
 depends on dim.  $B_a$   
 $B_{Ra}$  = Outer trough width

!  $H_{Ri} \geq 2 \cdot h_a$   
 $B_{Ri} \geq B_a + 4$

- = Guide trough
- = Glide bar
- = Installation set "Basic"
- = C-profile



**Calculation - travel center mounted**

Half travel length, rounded down to full 2 m sections =  $X$  m **guide trough length without glide bars** +  $X$  m **guide trough length with glide bars** + installation sets "Basic" (number of trough pieces + 1)

Supplement Part No. with the indicated C-profile-length-index.  
**Example:** 960.50.200  
 C-profile length-index for your chosen trough inner width  $B_{Ri}$  ► see table on the right or the respective page for chosen series



**Fixed end module** - A quick fix for mounting the stationary end of an E-Chain® ► **page 9.16**

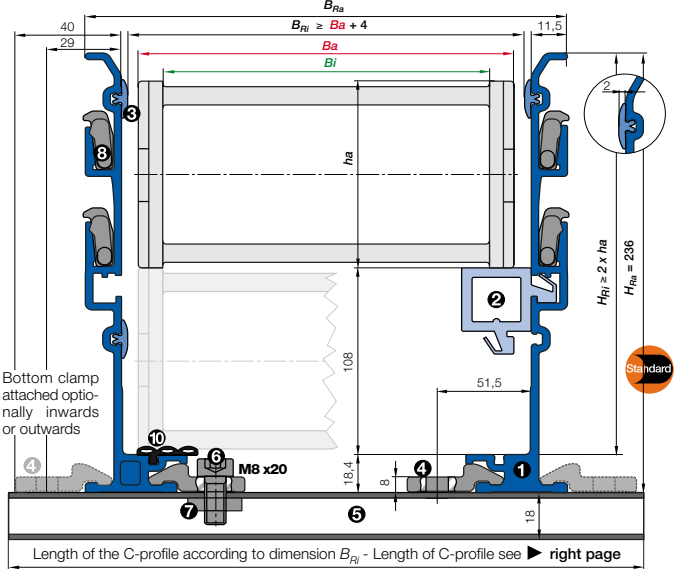

- **Components, trough "Basic":** ① Trough side parts, aluminum, 2 m ② Glide bar, plastic, 2 m ③ Glide strips, plastic, 2 m (without glide strips on request) ⑩ Optional: Silencer profile, rubber
- **Components, installation set "Basic":** ④ Bottom clamp, aluminum ⑤ C-profile, steel galvanized ⑥ Screw M8 x 20 ⑦ Sliding nut M8 ⑧ Interface connector, plastic

**Basic version: Aluminum "SuperTrough" components**

Complete guide trough sets - description	Part No.	Weight	kg
① Set of 2 trough side parts, incl. glide strips, without glide bars, 2 m section	975.30.SL	≈ 14,0	kg
① Set of 2 trough side parts, incl. glide strips, with glide bars, 2 m section	975.31.SL	≈ 16,6	kg
1 Installation set "Basic" without C-profile	960.50	≈ 0,08	kg
1 Installation set "Basic" with C-profile	960.50.		
Single parts - description			
⑥ 1 Glide strip, individual, 2 m section	75.01	≈ 0,06	kg
⑩ 1 Silencer profile, rubber, individual, 2 m section	75.68.H		
④ 1 Bottom clamp, individual	75.50	≈ 0,04	kg
⑧ 1 Interface connector, individual	75.60		
⑥ 1 Screw M8 x 20, individual	MAT 0040445		
⑦ 1 Sliding nut M8, individual	MAT 0040413		
② 1 Glide bar, individual, 2 m section	83.79	≈ 1,30	kg
⑤ 1 C-profile, individual	92.52.	≈ 0,90	kg/m



**Order example: Length of travel 30 m - Center mounted for Series 5050.30.300.0 with  $B_{Ri} = 345$**

Guide trough set (set of 2 trough side parts, incl. glide strips) <b>without</b> glide bar		
<b>Order text:</b> 16 m guide trough without glide bar (8 x 2 m sections)	<b>Part No.</b>	<b>975.30.SL</b>
Guide trough set (set of 2 trough side parts, incl. glide strips) <b>with</b> glide bar		
<b>Order text:</b> 16 m guide trough with glide bar (8 x 2 m sections)	<b>Part No.</b>	<b>975.31.SL</b>
Installation set "Basic" complete (guide trough-sets + 1)		
<b>Order text:</b> 17 installation sets "Basic"	<b>Part No.</b>	<b>960.50.425</b>
Module for the fixed end		
<b>Order text:</b> 1 set		<b>975.80</b>
<b>Option:</b> For an additional noise dampening with silencer profile, please add Index A Example:	<b>Part No.</b>	<b>975.30.SLA</b>

## Lengths of C-profile for Basic version - Bottom clamp attached optionally inwards or outwards

5050/5150/R9850				15050/15150/R19850				E6.80L				E6.80			
5050.05.200.0				15050.05.200.0				E6.80L.30.300.0				E6.80.30.300.0			
$B_{Ri}$ [mm]	Part No. attached inwards	Part No. attached outwards		$B_{Ri}$ [mm]	Part No. attached inwards	Part No. attached outwards		$B_{Ri}$ [mm]	Part No. attached inwards	Part No. attached outwards		$B_{Ri}$ [mm]	Part No. attached inwards	Part No. attached outwards	
.05	104	*	960.50.225	.05	84	*	960.50.200	.11	144	960.50.200	960.50.275	.05	104	*	960.50.225
.06	119	*	960.50.250	.07	109	*	960.50.225	.12	157	960.50.225	960.50.275	.06	119	*	960.50.250
.07	129	*	960.50.250	.10	134	*	960.50.250	.13	169	960.50.225	960.50.300	.07	129	*	960.50.250
.10	154	960.50.225	960.50.275	.11	146	960.50.200	960.50.275	.15	182	960.50.250	960.50.300	.10	154	960.50.225	960.50.275
.11	167	960.50.225	960.50.300	.12	159	960.50.225	960.50.275	.16	194	960.50.250	960.50.325	.11	167	960.50.225	960.50.300
.12	179	960.50.250	960.50.300	.13	171	960.50.225	960.50.300	.17	207	960.50.275	960.50.325	.12	179	960.50.250	960.50.300
.13	192	960.50.250	960.50.325	.15	184	960.50.250	960.50.300	.18	219	960.50.275	960.50.350	.13	192	960.50.250	960.50.325
.15	204	960.50.275	960.50.325	.16	196	960.50.250	960.50.325	.20	232	960.50.300	960.50.350	.15	204	960.50.275	960.50.325
.16	217	960.50.275	960.50.350	.17	209	960.50.275	960.50.325	.21	244	960.50.300	960.50.375	.16	217	960.50.275	960.50.350
.17	229	960.50.300	960.50.350	.18	221	960.50.275	960.50.350	.22	257	960.50.325	960.50.375	.17	229	960.50.300	960.50.350
.18	242	960.50.300	960.50.375	.20	234	960.50.300	960.50.350	.23	269	960.50.325	960.50.400	.18	242	960.50.300	960.50.375
.20	254	960.50.325	960.50.375	.21	246	960.50.300	960.50.375	.25	282	960.50.350	960.50.400	.20	254	960.50.325	960.50.375
.21	267	960.50.325	960.50.400	.22	259	960.50.325	960.50.375	.26	294	960.50.350	960.50.425	.21	267	960.50.325	960.50.400
.22	279	960.50.350	960.50.400	.23	271	960.50.325	960.50.400	.27	307	960.50.375	960.50.425	.22	279	960.50.350	960.50.400
.23	292	960.50.350	960.50.425	.25	284	960.50.350	960.50.400	.28	319	960.50.375	960.50.450	.23	292	960.50.350	960.50.425
.25	304	960.50.375	960.50.425	.26	296	960.50.350	960.50.425	.30	332	960.50.400	960.50.450	.25	304	960.50.375	960.50.425
.26	317	960.50.375	960.50.450	.27	309	960.50.375	960.50.425	.31	344	960.50.400	960.50.475	.26	317	960.50.375	960.50.450
.27	329	960.50.400	960.50.450	.28	321	960.50.375	960.50.450	.32	357	960.50.425	960.50.475	.27	329	960.50.400	960.50.450
.28	342	960.50.400	960.50.475	.30	334	960.50.400	960.50.450	.33	369	960.50.425	960.50.500	.28	342	960.50.400	960.50.475
.30	354	960.50.425	960.50.475	.31	346	960.50.400	960.50.475	.35	382	960.50.450	960.50.500	.30	354	960.50.425	960.50.475
.31	367	960.50.425	960.50.500	.32	359	960.50.425	960.50.475	.36	394	960.50.450	960.50.525	.31	367	960.50.425	960.50.500
.32	379	960.50.450	960.50.500	.33	371	960.50.425	960.50.500	.37	407	960.50.475	960.50.525	.32	379	960.50.450	960.50.500
.33	392	960.50.450	960.50.525	.35	384	960.50.450	960.50.500	.38	419	960.50.475	960.50.550	.33	392	960.50.450	960.50.525
.35	404	960.50.475	960.50.525	.36	396	960.50.450	960.50.525	.40	432	960.50.500	960.50.550	.35	404	960.50.475	960.50.525
.36	417	960.50.475	960.50.550	.37	409	960.50.475	960.50.525	.41	444	960.50.500	960.50.575	.36	417	960.50.475	960.50.550
.37	429	960.50.500	960.50.550	.38	421	960.50.475	960.50.550	.42	457	960.50.525	960.50.575	.37	429	960.50.500	960.50.550
.38	442	960.50.500	960.50.575	.40	434	960.50.500	960.50.550	.43	469	960.50.525	960.50.600	.38	442	960.50.500	960.50.575
.40	454	960.50.525	960.50.575	.41	446	960.50.500	960.50.575	.45	482	960.50.550	960.50.600	.40	454	960.50.525	960.50.575
.41	467	960.50.525	960.50.600	.42	459	960.50.525	960.50.575	.46	494	960.50.550	960.50.625	.41	467	960.50.525	960.50.600
.42	479	960.50.550	960.50.600	.43	471	960.50.525	960.50.600	.47	507	960.50.575	960.50.625	.42	479	960.50.550	960.50.600
.43	492	960.50.550	960.50.625	.45	484	960.50.550	960.50.600	.48	519	960.50.575	960.50.650	.43	492	960.50.550	960.50.625
.45	504	960.50.575	960.50.625	.46	496	960.50.550	960.50.625	.50	532	960.50.600	960.50.650	.45	504	960.50.575	960.50.625
.46	517	960.50.575	960.50.650	.47	509	960.50.575	960.50.625	.51	544	960.50.600	960.50.675	.46	517	960.50.575	960.50.650
.47	529	960.50.600	960.50.650	.48	521	960.50.575	960.50.650	.52	557	960.50.625	960.50.675	.47	529	960.50.600	960.50.650
.48	542	960.50.600	960.50.675	.50	534	960.50.600	960.50.650	.53	569	960.50.625	960.50.700	.48	542	960.50.600	960.50.675
.50	554	960.50.625	960.50.675	.51	546	960.50.600	960.50.675	.55	582	960.50.650	960.50.700	.50	554	960.50.625	960.50.675
.51	567	960.50.625	960.50.700	.52	559	960.50.625	960.50.675					.51	567	960.50.625	960.50.700
.52	579	960.50.650	960.50.700	.53	571	960.50.625	960.50.700					.52	579	960.50.650	960.50.700
.53	592	960.50.650	960.50.725	.55	584	960.50.650	960.50.700					.53	592	960.50.650	960.50.725
.55	604	960.50.675	960.50.725	.60	634	960.50.700	960.50.750					.55	604	960.50.675	960.50.725
.60	654	960.50.725	960.50.775									.60	654	960.50.725	960.50.775

\*upon request

## "Heavy Duty" Version | Installation set Part No. 975.50

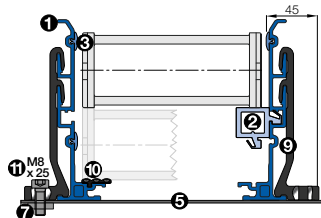

- Components, trough "Heavy Duty": ① Trough side parts, aluminum, 2 m ② Glide bar, plastic, 2 m ③ Glide strips, plastic 2 m (without glide strips on request) ⑩ Optional: Silencer profile, rubber
- Components, installation set "Heavy Duty": ⑤ C-profile, steel galvanized ⑦ Sliding nut M8 ⑧ Heavy duty bracket, aluminum ⑪ Screw M8 x 25

Note: Dimensions similar to Basic version!  
Exception: Heavy duty bracket, see drawing



- = Guide trough
- = Glide bar
- = Installation set "Heavy duty"
- = C-profile

Insert for the installation set "Heavy-Duty": **975.50.XXX** instead of **960.50.XXX** on the right column "attached outwards"  
"Heavy Duty" installation set Part No. **975.50.200**



For the following  
E-Chains®/E-Tubes:

**System E4 Series**

- 5050HD/R9850HD

We especially recommend for theigus® E4/4 series 5050 HD (Heavy Duty) this trough system. Structurally identical with trough 975.30.SL yet with special HD-installation set, suitable for ambitious applications.

- $B_a$  = Outer E-Chain® width
- $B_i$  = Inner E-Chain® width
- $h_a$  = E-Chain® outer height
- $H_{Ri}$  = Inner trough height
- $H_{Ra}$  = Outer trough height
- $B_{Ri}$  = Inner trough width ▶ depends on dim.  $B_a$
- $B_{Ra}$  = Outer trough width

!  $H_{Ri} \geq 2 \cdot h_a$   
■  $B_{Ri} \geq B_a + 4$

- = Guide trough
- = Glide bar
- = Installation set "Basic"
- = C-profile

**Calculation - travel center mounted**

Half travel length, rounded down to full 2 m sections = **X m guide trough length without glide bars** + X m **guide trough length with glide bars** + **installation sets "Basic"** (number of trough pieces + 1)

Supplement Part No. with the indicated C-profile-length-index.  
**Example: 974.50.200**  
C-profile length-index for your chosen trough inner width  $B_{Ri}$  ▶ see table on the right or the respective page for chosen series

**Fixed end module** - A quick fix for mounting the stationary end of an E-Chain® ▶ **page 9.16**

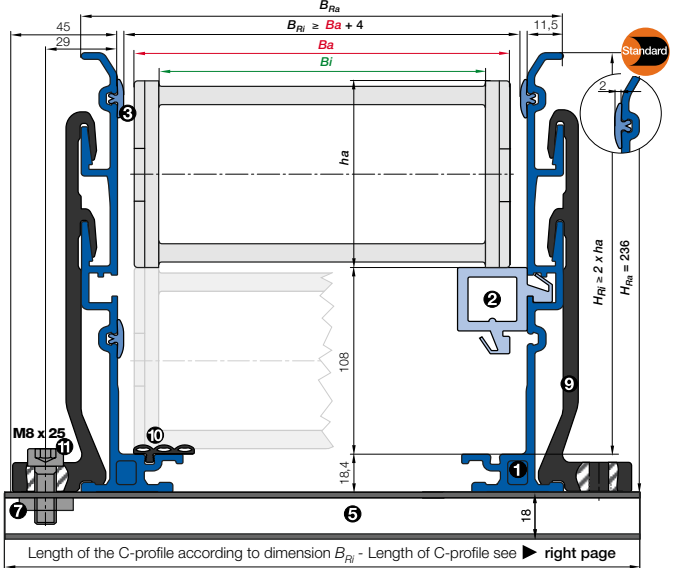

- Components, trough "Heavy Duty": ① Trough side parts, aluminum, 2 m ② Glide bar, plastic, 2 m ③ Glide strips, plastic, 2 m (without glide strips on request) ⑩ Optional: Silencer profile, rubber
- Components, installation set "Heavy Duty": ⑤ C-profile, steel galvanized ⑦ Sliding nut M8 ⑨ Heavy duty bracket, aluminum ⑪ Screw M8 x 25

**Heavy Duty version: Aluminum "SuperTrough" components**

Complete guide trough sets - description	Part No.	Weight
① Set of 2 trough side parts, incl. glide strips, without glide bars, 2 m section	975.30.SL	≈ 14,0 kg
① Set of 2 trough side parts, incl. glide strips, with glide bars, 2 m section	975.31.SL	≈ 16,6 kg
1 Installation set "Heavy Duty" without C-profile	975.50	≈ 0,53 kg
1 Installation set "Heavy Duty" with C-profile	975.50. <input type="text"/>	
Single parts - description		
③ 1 Glide strip, individual, 2 m section	75.01	≈ 0,06 kg
⑩ 1 Silencer profile, rubber, individual, 2 m section	75.68.H	
⑪ 1 Screw M8 x 25, individual	MAT 0040445	
⑦ 1 Sliding nut M8, individual	MAT 0040413	
② 1 Glide bar, individual, 2 m section	83.79	≈ 1,30 kg
⑤ 1 C-profile, individual	92.52. <input type="text"/>	≈ 0,90 kg/m



**Order example: Length of travel 30 m - Center mounted for Series 5050HD.10.250.0 with  $B_{Ri} = 164$**

Guide trough set (set of 2 trough side parts, incl. glide strips) <b>without</b> glide bar		
<b>Order text:</b> 16 m guide trough without glide bar (8 x 2 m sections)	Part No.	975.30.SL
Guide trough set (set of 2 trough side parts, incl. glide strips) <b>with</b> glide bar		
<b>Order text:</b> 16 m guide trough with glide bar (8 x 2 m sections)	Part No.	975.31.SL
Installation set "Heavy Duty" complete (guide trough-sets + 1)		
<b>Order text:</b> 17 installation sets "Heavy Duty"	Part No.	974.50. 300
Module for the fixed end		
<b>Order text:</b> 1 set		975.80
<b>Option:</b> For an additional noise dampening with silencer profile, please add Index A Example:	Part No.	975.30.SLA

Lengths of C-profile

5050HD/R9850HD

5050HD.30.300.0

$B_{R1}$ [mm]	Part No. assembled
.05 114	974.50.250
.06 129	974.50.250
.07 139	974.50.275
.10 164	974.50.300
.11 176	974.50.300
.12 189	974.50.325
.13 201	974.50.325
.15 214	974.50.350
.16 226	974.50.350
.17 239	974.50.375
.18 251	974.50.375
.20 264	974.50.400
.21 276	974.50.400
.22 289	974.50.425
.23 301	974.50.425
.25 314	974.50.450
.26 326	974.50.450
.27 339	974.50.475
.28 351	974.50.475
.30 364	974.50.500
.31 376	974.50.500
.32 389	974.50.525
.33 401	974.50.525
.35 414	974.50.550
.36 426	974.50.550
.37 439	974.50.575
.38 451	974.50.575
.40 464	974.50.600
.41 476	974.50.600
.42 489	974.50.625
.43 501	974.50.625
.45 514	974.50.650
.46 526	974.50.650
.47 539	974.50.675
.48 551	974.50.675
.50 564	974.50.700
.51 576	974.50.700
.52 589	974.50.725
.53 601	974.50.725
.55 614	974.50.750
.60 664	974.50.800

# Series 5050HD Heavy-Duty

## For long travels and high fill weights

Compared to the standard 5050: ● Higher tensile strength ● Times larger support areas at the stop dogs  
● Increased side wall thickness ● Support area at pin increased ● Application examples: Cranes, composting plants, concrete plants, mining.

**Series 5050HD ▶ from page 7.148**

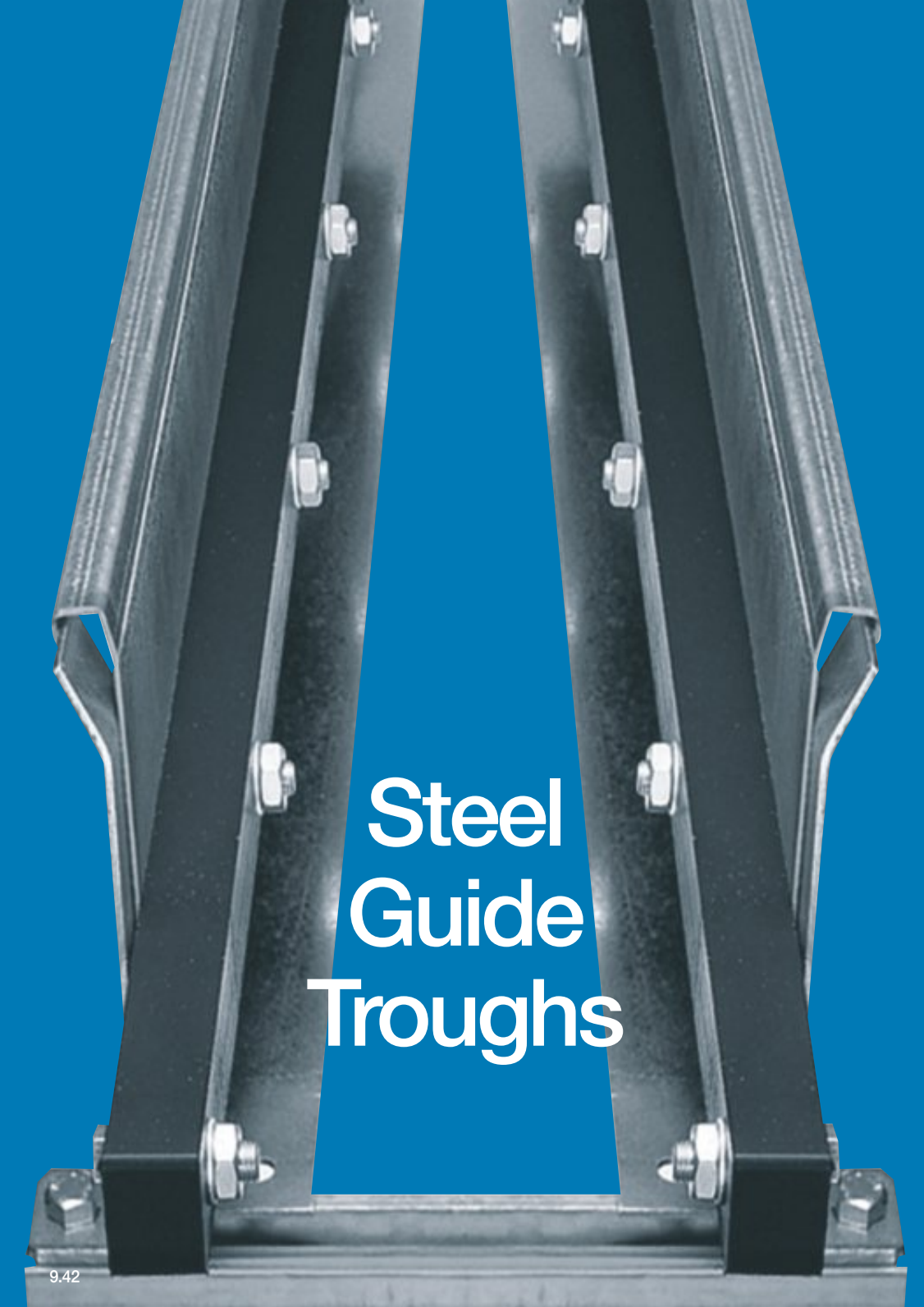

A close-up, low-angle photograph of a steel guide trough assembly. The assembly consists of two main vertical channels, each formed by two parallel steel beams. These channels are connected at the top and bottom by horizontal cross-braces. The entire structure is held together by several large, silver-colored bolts. The background is a solid, vibrant blue. The text "Steel Guide Troughs" is overlaid in the center in a white, sans-serif font.

# Steel Guide Troughs

## Steel guide trough - very stable and rugged for heavy duty applications

If the igus® installation sets are used, the guide troughs are particularly easy to assemble. All the steel guide troughs are constructed according to the same basic principle. On the following pages, you will find information about dimensions, weights and accessories according to the trough size. You will find all necessary design data to stipulate the assembly width on. All sizes use a common C-profile on which the guide parts are assembled. The assembly brackets used vary in height only.

- Easy assembly with installation set
- Big range, two piece design, adjustable to E-Chain® width
- Available in galvanized steel and stainless steel
- Glide bar made of PE

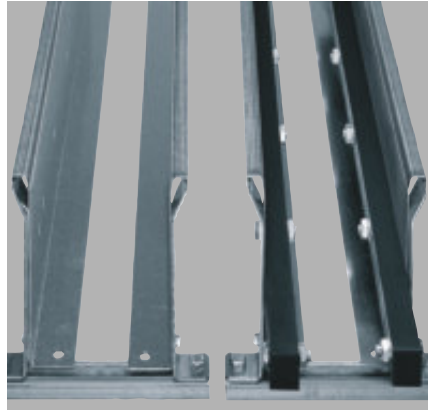

Steel guide trough without and with glide bars

## Side view of trough joint and C-profile

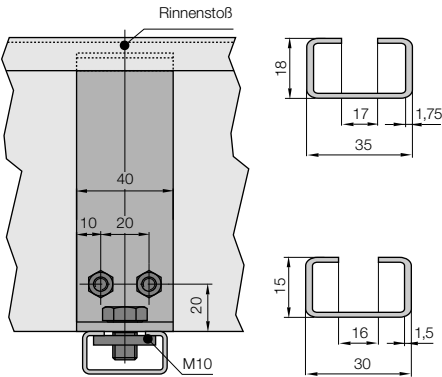

Side view of trough joint. All the dimensions, apart from the height, apply to all sizes

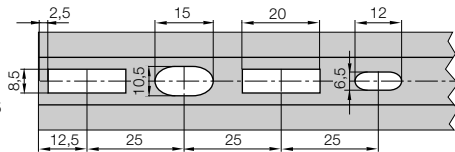

Part No. 92.52.XX

C-profile drilling pattern - normally galvanized version

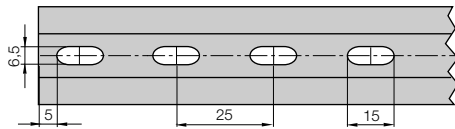

Part No. 92.52.XX.E

C-profile drilling pattern - stainless steel version



Long travel with igus® steel guide trough and harnessed igus® E-Chain® on a crane

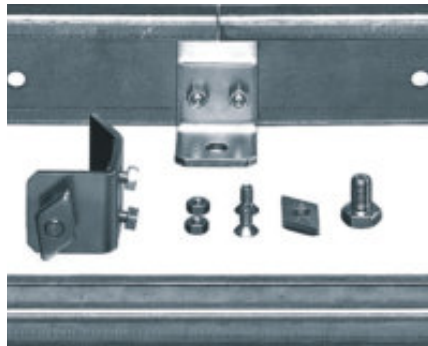

Installation set for joint and attachment surface connections secure connection without misalignment and without welding



For the following  
E-Chains®/E-Tubes:

**System E2 Series**

● 2400/2500/2450/2480

● 255

● 240/240/250 classic

**System E6 Series**

● E6.29/R6.29



**Fixed end module**

Quick installation of the mounting brackets due to the prepared bores

► page 9.62

- $B_a$  = Outer E-Chain® width
- $B_i$  = Inner E-Chain® width
- $h_a$  = E-Chain® outer height
- $H_{Ri}$  = Inner trough height
- $H_{Ra}$  = Outer trough height
- $B_{Ri}$  = Inner trough width ► depends on dim.  $B_a$
- $B_{Ra}$  = Outer trough width
- $n_{Mon}$  = Number of installation sets (left/right)
- $n_{Ri}$  = Number of trough sets (left/right)
- !  $H_{Ri} \geq 2 \cdot h_a$
- !  $B_{Ri} \geq B_a + 5$
- = Guide trough
- = Glide bar
- = Installation set
- = C-profile

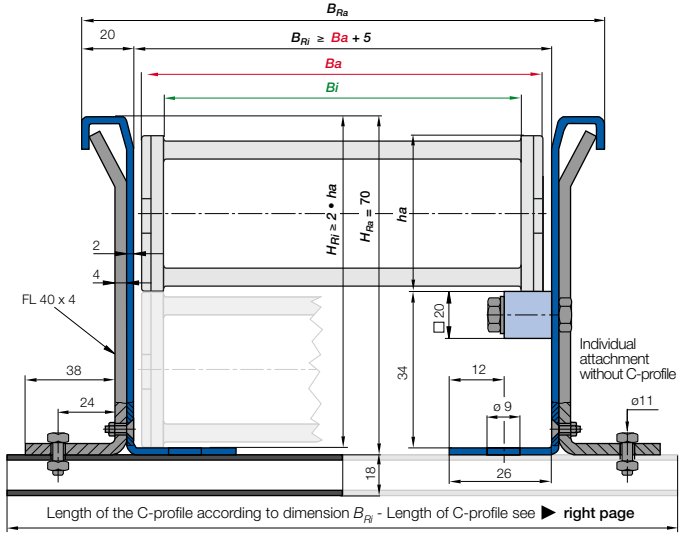

**Steel Guide Trough components - Sets and single parts**

Complete guide trough sets - description	Part No.	Weight	kg
Set of 2 trough side parts <b>without</b> glide bars, 2 m section	92.30	≈ 7,60 kg	
Set of 2 trough side parts <b>with</b> glide bars, 2 m section	92.31	≈ 9,60 kg	
1 Installation set "Basic" with C-profile	92.50. <input type="text"/>		
1 Installation set "Basic" without C-profile	92.50	≈ 0,34 kg	
Single parts - description			
1 glide bar, individual, each 2 m	92.01	≈ 0,75 kg	
1 glide bar, individual, each 2 m + 11 screw sets	92.20	≈ 0,98 kg	
11 screw sets for 2 m sections	92.21	≈ 0,23 kg	
1 Clamping bracket, individual	92.51	≈ 0,12 kg	
1 Countersunk-head screw M6 x 14, individual	92.53		
1 Hexagon nut M6, individual	92.54		
1 Hexagon-head screw M10 x 16, individual	92.55		
1 Glide nut M10, individual	92.56		
1 C-profile, individual	92.52. <input type="text"/>	≈ 0,90 kg/m	

Supplement Part No. with the indicated C-profile-length-index. Example: 92.50.

C-profile-length-index for your chosen trough inner width  $B_{Ri}$  ► right table

Trough side parts also available in stainless steel. Please add index "E" to the Part No. 92.30.E

**Principle sketch: Number of installation sets which have to be installed**

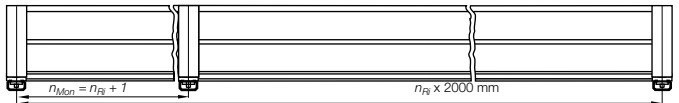

Calculation - travel center mounted

Half travel length, rounded down to full 2 m sections = X m guide trough length without glide bars + X m guide trough length with glide bars + installation sets (number of trough pieces + 1)



Order example: Length of travel 30 m - Center mounted for Series 2500.05 with  $B_{Ri} = 78$

Guide trough-set of 2 trough side parts, <b>without</b> glide bars:		
16 m Guide trough = 8 x 2 m sections (without glide bars)	Part No. 92.30	
Guide trough-set of 2 trough side parts, <b>with</b> assembled glide bars:		
16 m Guide trough = 8 x 2 m sections (with glide bars)	Part No. 92.31	
Installation sets complete (Guide trough-sets + 1)	Part No. 92.50. <input type="text"/>	
17 Installation sets (with C-profile)		







For the following  
E-Chains®/E-Tubes:

- System E2 Series**
- 2600/2650/2680/2700
- 26/27/271 classic
- System E2 Tubes Series**
- R58/R58 classic



**Fixed end module**

Quick installation of the mounting brackets due to the prepared bores

▶ page 9.62

- $B_a$  = Outer E-Chain® width
- $B_i$  = Inner E-Chain® width
- $h_a$  = E-Chain® outer height
- $H_{Ri}$  = Inner trough height
- $H_{Ra}$  = Outer trough height
- $B_{Ri}$  = Inner trough width ▶ depends on dim.  $B_a$
- $B_{Ra}$  = Outer trough width
- $n_{Mon}$  = Number of installation sets (left/right)
- $n_{Ri}$  = Number of trough sets (left/right)
- $H_{Ri} \geq 2 \cdot h_a$**
- $B_{Ri} \geq B_a + 5$**
- = Guide trough
- = Glide bar
- = Installation set
- = C-profile

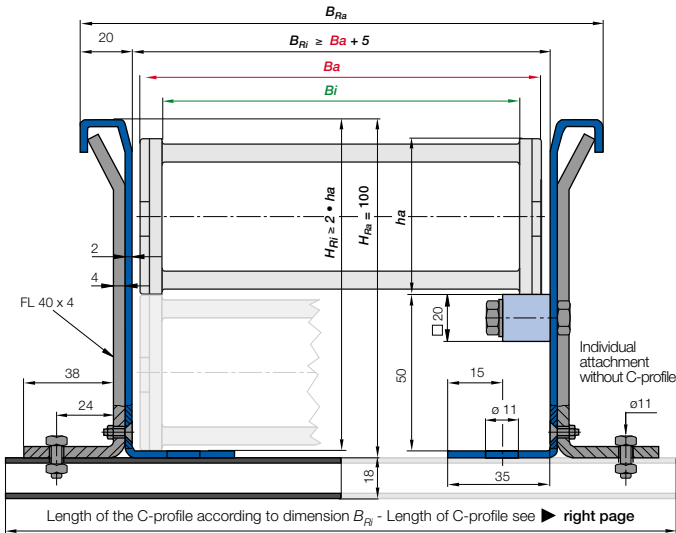

**Steel Guide Trough components - Sets and single parts**

Complete guide trough sets - description	Part No.	Weight	kg
Set of 2 trough side parts <b>without</b> glide bars, 2 m section	95.30	≈ 10,00 kg	
Set of 2 trough side parts <b>with</b> glide bars, 2 m section	95.31	≈ 12,00 kg	
1 Installation set "Basic" with C-profile	95.50. <input type="text"/>		
1 Installation set "Basic" without C-profile	95.50	≈ 0,41 kg	
Single parts - description			
1 glide bar, individual, each 2 m	92.01	≈ 0,75 kg	
1 glide bar, individual, each 2 m + 11 screw sets	92.20	≈ 0,98 kg	
11 screw sets for 2 m sections	92.21	≈ 0,23 kg	
1 Clamping bracket, individual	95.51	≈ 0,16 kg	
1 Countersunk-head screw M6 x 14, individual	92.53		
1 Hexagon nut M6, individual	92.54		
1 Hexagon-head screw M10 x 16, individual	92.55		
1 Glide nut M10, individual	92.56		
1 C-profile, individual	92.52. <input type="text"/>	≈ 0,90 kg/m	

Supplement Part No. with the indicated C-profile-length-index. Example: 95.50.

C-profile-length-index for your chosen trough inner width  $B_{Ri}$  ▶ right table

Trough side parts also available in stainless steel. Please add index "E" to the Part No. 95.30.E

**Principle sketch: Number of installation sets which have to be installed**

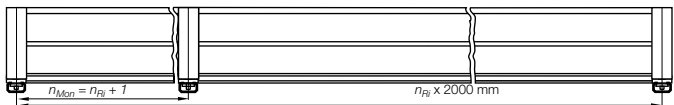

Calculation - travel center mounted

Half travel length, rounded down to full 2 m sections = X m guide trough length without glide bars + X m guide trough length with glide bars + installation sets (number of trough pieces + 1)



Order example: Length of travel 30 m - Center mounted for Series 2700.05 with  $B_{Ri} = 71$

Guide trough-set of 2 trough side parts, <b>without</b> glide bars:		
16 m Guide trough = 8 x 2 m sections (without glide bars)	Part No. 95.30	
Guide trough-set of 2 trough side parts, <b>with</b> assembled glide bars:		
16 m Guide trough = 8 x 2 m sections (with glide bars)	Part No. 95.31	
Installation sets complete (Guide trough-sets + 1)		
17 Installation sets (with C-profile)	Part No. 95.50. <input type="text"/>	

Part No. Installation set: Steel Guide Trough with C-profile (in dependance of the width)

**2600/2650/2680/2700**

2600\_05.200.0

**R58**

58\_050.200.0

$B_{Ri}$	Part No.	$B_{Ri}$	Part No.
[mm]	Installation set	[mm]	Installation set
.05	71 95.50.200	.050	71 95.50.200
.06	86 95.50.200	.075	96 95.50.225
.07	96 95.50.225	.100	121 95.50.250
.09	111 95.50.225	.125	146 95.50.275
.10	121 95.50.250	.150	171 95.50.300
.12	146 95.50.275	.175	196 95.50.325
.15	171 95.50.300	.200	221 95.50.350
.17	199 95.50.325		



igus® steel guide trough used in a shelf conveyor application, series 350 and Chainflex® cables



For the following  
E-Chains®/E-Tubes:

**System E4 Series**

- 220/R760
- 22/23/R76 classic
- E6.35



**Fixed end module**

Quick installation of the mounting brackets due to the prepared bores

▶ page 9.62

- $B_a$  = Outer E-Chain® width
- $B_i$  = Inner E-Chain® width
- $h_a$  = E-Chain® outer height
- $H_{Ri}$  = Inner trough height
- $H_{Ra}$  = Outer trough height
- $B_{Ri}$  = Inner trough width ▶ depends on dim.  $B_a$
- $B_{Ra}$  = Outer trough width
- $n_{Mon}$  = Number of installation sets (left/right)
- $n_{Ri}$  = Number of trough sets (left/right)
- !  $H_{Ri} \geq 2 \cdot h_a$
- !  $B_{Ri} \geq B_a + 5$
- = Guide trough
- = Glide bar
- = Installation set
- = C-profile

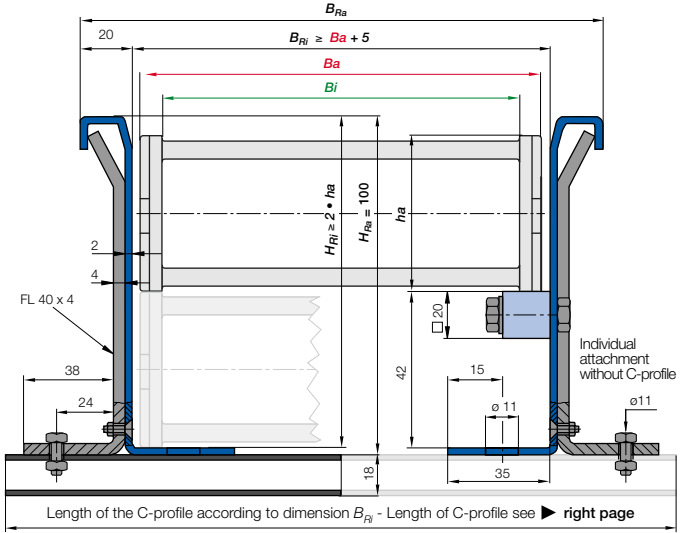

**Steel Guide Trough components - Sets and single parts**

Complete guide trough sets - description	Part No.	Weight	kg
Set of 2 trough side parts <b>without</b> glide bars, 2 m section	99.30	≈ 10,00 kg	
Set of 2 trough side parts <b>with</b> glide bars, 2 m section	99.31	≈ 12,00 kg	
1 Installation set "Basic" with C-profile	95.50. <input type="text"/>		
1 Installation set "Basic" without C-profile	95.50.	≈ 0,41 kg	
Single parts - description			
1 glide bar, individual, each 2 m	92.01	≈ 0,75kg	
1 glide bar, individual, each 2 m + 11 screw sets	92.20	≈ 0,98 kg	
11 screw sets for 2 m sections	92.21	≈ 0,23 kg	
1 Clamping bracket, individual	95.51	≈ 0,16 kg	
1 Countersunk-head screw M6 x 14, individual	92.53		
1 Hexagon nut M6, individual	92.54		
1 Hexagon-head screw M10 x 16, individual	92.55		
1 Glide nut M10, individual	92.56		
1 C-profile, individual	92.52. <input type="text"/>	≈ 0,90 kg/m	

Supplement Part No. with the indicated C-profile-length-index. Example: 95.50.

C-profile-length-index for your chosen trough inner width  $B_{Ri}$  ▶ right table

Trough side parts also available in stainless steel. Please add index "E" to the Part No. 99.30.E

**Principle sketch: Number of installation sets which have to be installed**

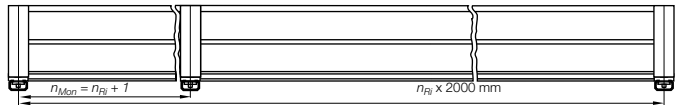

Calculation - travel center mounted

Half travel length, rounded down to full 2 m sections = X m guide trough length without glide bars + X m guide trough length with glide bars + installation sets (number of trough pieces + 1)



Order example: Length of travel 30 m - Center mounted for Series 220.050 with  $B_{Ri} = 75$

Guide trough-set of 2 trough side parts, <b>without</b> glide bars:		
16 m Guide trough = 8 x 2 m sections (without glide bars)	Part No. 99.30	
Guide trough-set of 2 trough side parts, <b>with</b> assembled glide bars:		
16 m Guide trough = 8 x 2 m sections (with glide bars)	Part No. 99.31	
Installation sets complete (Guide trough-sets + 1)		
17 Installation sets (with C-profile)	Part No. 95.50. <input type="text" value="200"/>	





For the following  
E-Chains®/E-Tubes:

**System E4 Series**

- 280/290/R770
- 2828/2928/R7728
- 28/29/R77 classic

**System E6 Series**

- E6.40/R6.40



**Fixed end module**

Quick installation of the mounting brackets due to the prepared bores

▶ page 9.62

- $B_a$  = Outer E-Chain® width
- $B_i$  = Inner E-Chain® width
- $h_a$  = E-Chain® outer height
- $H_{Ri}$  = Inner trough height
- $H_{Ra}$  = Outer trough height
- $B_{Ri}$  = Inner trough width ▶ depends on dim.  $B_a$
- $B_{Ra}$  = Outer trough width
- $n_{Mon}$  = Number of installation sets (left/right)
- $n_{Ri}$  = Number of trough sets (left/right)
- !  $H_{Ri} \geq 2 \cdot h_a$
- !  $B_{Ri} \geq B_a + 5$
- = Guide trough
- = Glide bar
- = Installation set
- = C-profile

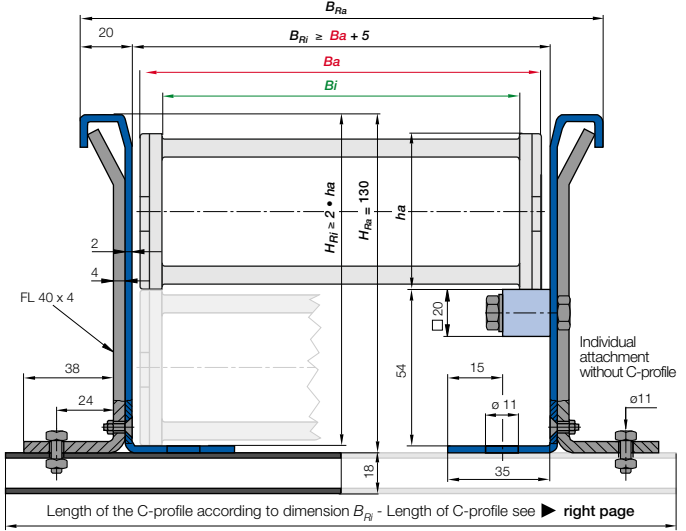

**Steel Guide Trough components - Sets and single parts**

Complete guide trough sets - description	Part No.	Weight	kg
Set of 2 trough side parts <b>without</b> glide bars, 2 m section	97.30	≈ 11,80 kg	
Set of 2 trough side parts <b>with</b> glide bars, 2 m section	97.31	≈ 13,60 kg	
1 Installation set "Basic" with C-profile	93.50. <input type="text"/>		
1 Installation set "Basic" without C-profile	93.50	≈ 0,49 kg	
Single parts - description			
1 glide bar, individual, each 2 m	92.01	≈ 0,75 kg	
1 glide bar, individual, each 2 m + 11 screw sets	92.20	≈ 0,98 kg	
11 screw sets for 2 m sections	92.21	≈ 0,23 kg	
1 Clamping bracket, individual	93.51	≈ 0,20 kg	
1 Countersunk-head screw M6 x 14, individual	92.53		
1 Hexagon nut M6, individual	92.54		
1 Hexagon-head screw M10 x 16, individual	92.55		
1 Glide nut M10, individual	92.56		
1 C-profile, individual	92.52. <input type="text"/>	≈ 0,90 kg/m	

Supplement Part No. with the indicated C-profile-length-index. Example: 93.50.

C-profile-length-index for your chosen trough inner width  $B_{Ri}$  ▶ right table

Trough side parts also available in stainless steel. Please add index "E" to the Part No. 97.30.E

**Principle sketch: Number of installation sets which have to be installed**

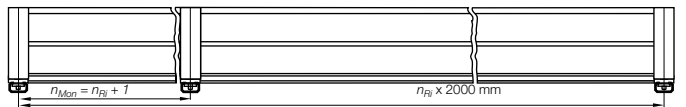

Calculation - travel center mounted

Half travel length, rounded down to full 2 m sections = X m guide trough length without glide bars + X m guide trough length with glide bars + installation sets (number of trough pieces + 1)



Order example: Length of travel 30 m - Center mounted for Series 2828.05 with  $B_{Ri} = 78$

Guide trough-set of 2 trough side parts, <b>without</b> glide bars:		
16 m Guide trough = 8 x 2 m sections (without glide bars)	Part No. 97.30	
Guide trough-set of 2 trough side parts, <b>with</b> assembled glide bars:		
16 m Guide trough = 8 x 2 m sections (with glide bars)	Part No. 97.31	
Installation sets complete (Guide trough-sets + 1)		
17 Installation sets (with C-profile)	Part No. 93.50. <input type="text"/>	









For the following  
E-Chains®/E-Tubes:

- System E2 Series**
- 3400/3450/3480/3500
- 340/350 classic
- System E2 Tubes Series**
- R68 ● R68 classic
- System E4 Series**
- 380/390/R780
- 3838/3938/R7838
- 38/39/R78 classic
- System E6 Series**
- E6.52/R6.52



**Fixed end module**

Quick installation of the mounting brackets due to the prepared bores

▶ page 9.62

- $B_a$  = Outer E-Chain® width
- $B_i$  = Inner E-Chain® width
- $h_a$  = E-Chain® outer height
- $H_{Ri}$  = Inner trough height
- $H_{Ra}$  = Outer trough height
- $B_{Ri}$  = Inner trough width ▶ depends on dim.  $B_a$
- $B_{Ra}$  = Outer trough width
- $n_{Mon}$  = Number of installation sets (left/right)
- $n_{Ri}$  = Number of trough sets (left/right)
- !  $H_{Ri} \geq 2 \cdot h_a$
- !  $B_{Ri} \geq B_a + 5$
- = Guide trough
- = Glide bar
- = Installation set
- = C-profile

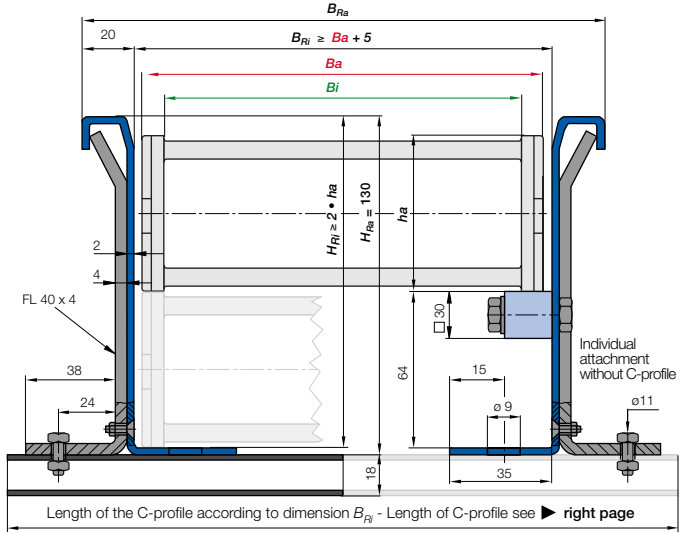

**Steel Guide Trough components - Sets and single parts**

Complete guide trough sets - description	Part No.	Weight	kg
Set of 2 trough side parts <b>without</b> glide bars, 2 m section	93.30	≈ 11,80 kg	
Set of 2 trough side parts <b>with</b> glide bars, 2 m section	93.31	≈ 16,20 kg	
1 Installation set "Basic" with C-profile	93.50. <input type="text"/>		
1 Installation set "Basic" without C-profile	93.50	≈ 0,49 kg	
Single parts - description			
1 glide bar, individual, each 2 m	93.01	≈ 1,68 kg	
1 glide bar, individual, each 2 m + 11 screw sets	93.20	≈ 2,22 kg	
11 screw sets for 2 m sections	93.21	≈ 0,54 kg	
1 Clamping bracket, individual	93.51	≈ 0,20 kg	
1 Countersunk-head screw M6 x 14, individual	92.53		
1 Hexagon nut M6, individual	92.54		
1 Hexagon-head screw M10 x 16, individual	92.55		
1 Glide nut M10, individual	92.56		
1 C-profile, individual	92.52. <input type="text"/>	≈ 0,90 kg/m	

Supplement Part No. with the indicated C-profile-length-index. Example: 93.50.

C-profile-length-index for your chosen trough inner width  $B_{Ri}$  ▶ right table

Trough side parts also available in stainless steel. Please add index "E" to the Part No. 93.30.E

**Principle sketch: Number of installation sets which have to be installed**

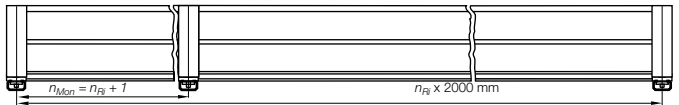

Calculation - travel center mounted

Half travel length, rounded down to full 2 m sections = X m guide trough length without glide bars + X m guide trough length with glide bars + installation sets (number of trough pieces + 1)



Order example: Length of travel 30 m - Center mounted for Series 3500.075 with  $B_{Ri} = 100$

Guide trough-set of 2 trough side parts, <b>without</b> glide bars:		
16 m Guide trough = 8 x 2 m sections (without glide bars)	Part No. 93.30	
Guide trough-set of 2 trough side parts, <b>with</b> assembled glide bars:		
16 m Guide trough = 8 x 2 m sections (with glide bars)	Part No. 93.31	
Installation sets complete (Guide trough-sets + 1)		
17 Installation sets (with C-profile)	Part No. 93.50. <input type="text"/>	

Part No. Installation set: Steel Guide Trough with C-profile (in dependence of the width)

**3400/3450/3480/3500**  
3400.050.200.0

$B_{Ri}$ [mm]	Part No. Installation set
.050	75 93.50.200
.075	100 93.50.225
.100	125 93.50.250
.115	140 93.50.250
.125	150 93.50.275
.150	175 93.50.300
.175	200 93.50.325
.200	225 93.50.350
.225	250 93.50.375
.250	275 93.50.400

**R68**  
68.050.200.0

$B_{Ri}$ [mm]	Part No. Installation set
.050	73 93.50.200
.075	98 93.50.225
.100	123 93.50.250
.115	138 93.50.250
.125	148 93.50.275
.150	173 93.50.300
.175	198 93.50.325
.200	223 93.50.350
.225	248 93.50.375
.250	273 93.50.400

**380/390/R780**  
390.07.200.0

$B_{Ri}$ [mm]	Part No. Installation set
.05	81 93.50.200
.06	99 93.50.225
.07	106 93.50.225
.087	119 93.50.250
.10	131 93.50.250
.11	139 93.50.250
.112	144 93.50.275
.12	156 93.50.275
.137	169 93.50.300
.15	181 93.50.300
.162	194 93.50.325
.17	199 93.50.325
.18	206 93.50.325
.187	219 93.50.350
.20	231 93.50.350
.212	244 93.50.375
.23	256 93.50.375
.237	269 93.50.400
.25	281 93.50.400
.262	294 93.50.425
.28	306 93.50.425
.29	319 93.50.450
.30	331 93.50.450
.312	344 93.50.475
.325	356 93.50.475
.337	369 93.50.500
.350	381 93.50.500
.362	394 93.50.525
.375	407 93.50.525
.387	419 93.50.550
.400	431 93.50.550

**3838/3938/R7838**  
3838.05.200.0

$B_{Ri}$ [mm]	Part No. Installation set
.05	82 93.50.200
.06	100 93.50.225
.07	107 93.50.225
.087	120 93.50.250
.10	132 93.50.250
.11	140 93.50.250
.112	145 93.50.275
.12	157 93.50.275
.137	170 93.50.300
.15	182 93.50.300
.162	195 93.50.325
.17	200 93.50.325
.18	207 93.50.325
.187	220 93.50.350
.20	232 93.50.350
.212	245 93.50.375
.23	257 93.50.375
.237	270 93.50.400
.25	282 93.50.400
.262	295 93.50.425
.28	307 93.50.425
.29	320 93.50.450
.30	332 93.50.450
.312	345 93.50.475
.325	357 93.50.475
.337	370 93.50.500
.350	382 93.50.500
.362	395 93.50.525
.375	407 93.50.525
.387	420 93.50.550
.400	432 93.50.550

**E6.52/R6.52**  
E6.52.040.200.0

$B_{Ri}$ [mm]	Part No. Installation set
.040	69 *
.050	79 93.50.200
.062	91 93.50.200
.070	99 93.50.225
.075	104 93.50.225
.100	129 93.50.250
.125	154 93.50.275
.150	179 93.50.300
.175	204 93.50.325
.200	229 93.50.350
.225	254 93.50.375
.250	279 93.50.400
.275	304 93.50.425
.300	329 93.50.450

\*upon request

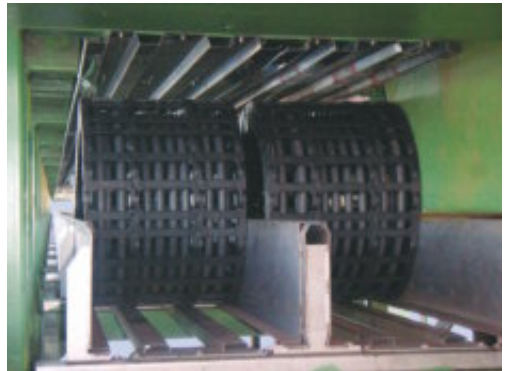

igus® System E4 with extension link at a ship loader for the coal unloading  
Travel 105 m, speed 240 m/min, load 53 kg/m



For the following  
E-Chains®/E-Tubes:

**System E4 Series**

- 400/410/R880
- 4040/4140/R8840
- 4040HD/R8840HD
- 40/41/R88 classic
- 140/141/R188 classic
- 142/143 classic
- 14040/14140/R18840
- 14240/14340

**System E6 Series**

- E6.62



**Fixed end module**

Quick installation of the mounting brackets due to the prepared bores

▶ page 9.62

- $B_a$  = Outer E-Chain® width
- $B_i$  = Inner E-Chain® width
- $h_a$  = E-Chain® outer height
- $H_{Ri}$  = Inner trough height
- $H_{Ra}$  = Outer trough height
- $B_{Ri}$  = Inner trough width ▶ depends on dim.  $B_a$
- $B_{Ra}$  = Outer trough width
- $n_{Mon}$  = Number of installation sets (left/right)
- $n_{Ri}$  = Number of trough sets (left/right)
- !  $H_{Ri} \geq 2 \cdot h_a$
- !  $B_{Ri} \geq B_a + 5$
- = Guide trough
- = Glide bar
- = Installation set
- = C-profile

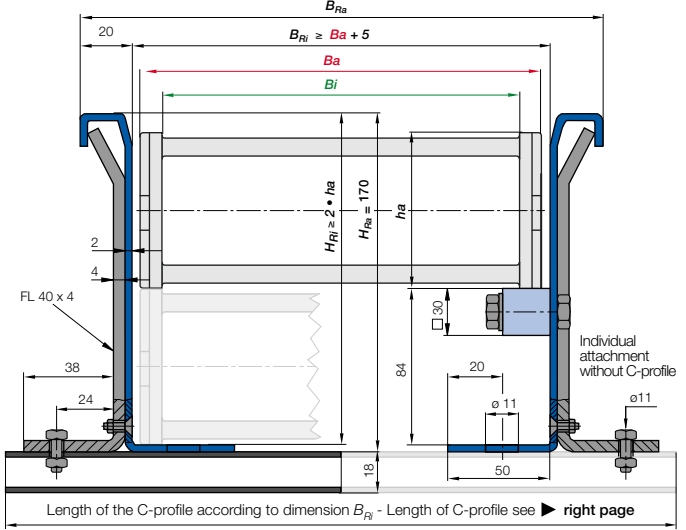

**Steel Guide Trough components - Sets and single parts**

Complete guide trough sets - description	Part No.	Weight	kg
Set of 2 trough side parts <b>without</b> glide bars, 2 m section	94.30	≈ 14,70 kg	
Set of 2 trough side parts <b>with</b> glide bars, 2 m section	94.31	≈ 19,00 kg	
1 Installation set "Basic" with C-profile	94.50. <input type="text"/>		
1 Installation set "Basic" without C-profile	94.50	≈ 0,58 kg	
Single parts - description			
1 glide bar, individual, each 2 m	93.01	≈ 1,68 kg	
1 glide bar, individual, each 2 m + 11 screw sets	93.20	≈ 2,22 kg	
11 screw sets for 2 m sections	93.21	≈ 0,54 kg	
1 Clamping bracket, individual	94.51	≈ 0,25 kg	
1 Countersunk-head screw M6 x 14, individual	92.53		
1 Hexagon nut M6, individual	92.54		
1 Hexagon-head screw M10 x 16, individual	92.55		
1 Glide nut M10, individual	92.56		
1 C-profile, individual	92.52. <input type="text"/>	≈ 0,90 kg/m	

Supplement Part No. with the indicated C-profile-length-index. Example: 94.50.

C-profile-length-index for your chosen trough inner width  $B_{Ri}$  ▶ right table

Trough side parts also available in stainless steel. Please add index "E" to the Part No. 94.30.E

**Principle sketch: Number of installation sets which have to be installed**

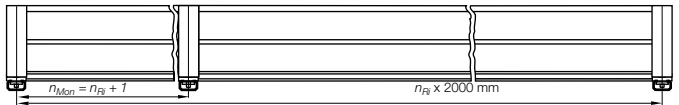

Calculation - travel center mounted

Half travel length, rounded down to full 2 m sections = X m guide trough length without glide bars + X m guide trough length with glide bars + installation sets (number of trough pieces + 1)



Order example: Length of travel 30 m - Center mounted for Series 400.06 with  $B_{Ri} = 104$

Guide trough-set of 2 trough side parts, <b>without</b> glide bars:		
16 m Guide trough = 8 x 2 m sections (without glide bars)	Part No. 94.30	
Guide trough-set of 2 trough side parts, <b>with</b> assembled glide bars:		
16 m Guide trough = 8 x 2 m sections (with glide bars)	Part No. 94.31	
Installation sets complete (Guide trough-sets + 1)	Part No. 94.50. <input type="text"/>	
17 Installation sets (with C-profile)	Part No. 94.50. <input type="text"/>	

## Part No. Installation set: Steel Guide Trough with C-profile (in dependence of the width)

400/410/R880			4040/4140/R8840			4040HD/R8840HD			14040/14140/R18840			14240/14340			E6.62		
400.10.200.0			4040.05.200.0			4040HD.05.200.0			14040.05.200.0			14240.05.200.0			E6.62.05.200.0		
$B_R$	Part No.	Installation set	$B_R$	Part No.	Installation set	$B_R$	Part No.	Installation set	$B_R$	Part No.	Installation set	$B_R$	Part No.	Installation set	$B_R$	Part No.	Installation set
[mm]			[mm]			[mm]			[mm]			[mm]			[mm]		
.05	89	*	.05	91	*	.05	109	94.50.225	.05	81	*	.05	81	*	.05	91	*
.06	104	94.50.225	.06	106	94.50.225	.06	124	94.50.250	.06	96	*	.06	99	*	.06	109	94.50.225
.07	114	94.50.225	.07	116	94.50.225	.07	134	94.50.250	.07	106	94.50.225	.07	106	94.50.225	.07	116	94.50.225
.10	139	94.50.250	.10	141	94.50.250	.10	159	94.50.275	.10	131	94.50.250	.087	119	94.50.250	.087	128	94.50.250
.11	152	94.50.275	.11	154	94.50.275	.11	171	94.50.300	.11	144	94.50.275	.10	131	94.50.250	.10	141	94.50.250
.12	164	94.50.275	.12	166	94.50.275	.12	184	94.50.300	.12	156	94.50.275	.11	139	94.50.250	.11	149	94.50.275
.13	177	94.50.300	.13	179	94.50.300	.13	196	94.50.325	.13	169	94.50.300	.112	144	94.50.275	.112	153	94.50.275
.15	189	94.50.300	.15	191	94.50.300	.15	209	94.50.325	.15	181	94.50.300	.12	156	94.50.275	.12	166	94.50.275
.16	202	94.50.325	.16	204	94.50.325	.16	221	94.50.350	.16	194	94.50.325	.137	169	94.50.300	.137	178	94.50.300
.17	214	94.50.325	.17	216	94.50.325	.17	234	94.50.350	.17	206	94.50.325	.15	181	94.50.300	.15	191	94.50.300
.18	227	94.50.350	.18	229	94.50.350	.18	246	94.50.375	.18	219	94.50.350	.162	194	94.50.325	.162	203	94.50.325
.20	239	94.50.350	.20	241	94.50.350	.20	259	94.50.375	.20	231	94.50.350	.17	199	94.50.325	.17	209	94.50.325
.21	252	94.50.375	.21	254	94.50.375	.21	271	94.50.400	.21	244	94.50.375	.18	206	94.50.325	.18	216	94.50.325
.22	264	94.50.375	.22	266	94.50.375	.22	284	94.50.400	.22	256	94.50.375	.187	219	94.50.350	.187	228	94.50.350
.23	277	94.50.400	.23	279	94.50.400	.23	296	94.50.425	.23	269	94.50.400	.20	231	94.50.350	.20	241	94.50.350
.25	289	94.50.400	.25	291	94.50.400	.25	309	94.50.425	.25	281	94.50.400	.212	244	94.50.375	.212	253	94.50.375
.26	302	94.50.425	.26	304	94.50.425	.26	321	94.50.450	.26	294	94.50.425	.23	256	94.50.375	.23	266	94.50.375
.27	314	94.50.425	.27	316	94.50.425	.27	334	94.50.450	.27	306	94.50.425	.237	269	94.50.400	.237	278	94.50.400
.28	327	94.50.450	.28	329	94.50.450	.28	346	94.50.475	.28	319	94.50.450	.25	281	94.50.400	.25	291	94.50.400
.30	339	94.50.450	.30	341	94.50.450	.30	359	94.50.475	.30	331	94.50.450	.262	294	94.50.425	.262	303	94.50.425
.31	352	94.50.475	.31	354	94.50.475	.31	371	94.50.500	.31	344	94.50.475	.28	306	94.50.425	.28	316	94.50.425
.32	364	94.50.475	.32	366	94.50.475	.32	384	94.50.500	.32	356	94.50.475	.29	319	94.50.450	.29	328	94.50.450
.33	377	94.50.500	.33	379	94.50.500	.33	396	94.50.525	.33	369	94.50.500	.30	331	94.50.450	.30	341	94.50.450
.35	389	94.50.500	.35	391	94.50.500	.35	409	94.50.525	.35	381	94.50.500	.312	344	94.50.475	.312	353	94.50.475
.36	402	94.50.525	.36	404	94.50.525	.36	421	94.50.550	.36	394	94.50.525	.325	356	94.50.475	.325	366	94.50.475
.37	414	94.50.525	.37	416	94.50.525	.37	434	94.50.550	.37	406	94.50.525	.337	369	94.50.500	.337	378	94.50.500
.38	427	94.50.550	.38	429	94.50.550	.38	446	94.50.575	.38	419	94.50.550	.350	381	94.50.500	.350	391	94.50.500
.40	439	94.50.550	.40	441	94.50.550	.40	459	94.50.575	.40	431	94.50.550	.362	394	94.50.525	.362	403	94.50.525
.41	452	94.50.575	.41	454	94.50.575	.41	471	94.50.600	.41	444	94.50.575	.375	406	94.50.525	.375	416	94.50.525
.42	464	94.50.575	.42	466	94.50.575	.42	484	94.50.600	.42	456	94.50.575	.384	419	94.50.550	.387	428	94.50.550
.43	477	94.50.600	.43	479	94.50.600	.43	496	94.50.625	.43	469	94.50.600	.400	431	94.50.550	.400	441	94.50.550
.45	489	94.50.600	.45	491	94.50.600	.45	509	94.50.625	.45	481	94.50.600						
.46	502	94.50.625	.46	504	94.50.625	.46	521	94.50.650	.46	494	94.50.625						
.47	514	94.50.625	.47	516	94.50.625	.47	534	94.50.650	.47	506	94.50.625						
.48	527	94.50.650	.48	529	94.50.650	.48	546	94.50.675	.48	519	94.50.650						
.50	539	94.50.650	.50	541	94.50.650	.50	559	94.50.675	.50	531	94.50.650						
.51	552	94.50.675	.51	554	94.50.675	.51	571	94.50.700	.51	544	94.50.675						
.52	564	94.50.675	.52	566	94.50.675	.52	584	94.50.700	.52	556	94.50.675						
.53	577	94.50.700	.53	579	94.50.700	.53	596	94.50.725	.53	569	94.50.700						
.55	589	94.50.700	.55	591	94.50.700	.55	609	94.50.725	.55	581	94.50.700						
.60	639	94.50.750	.60	641	94.50.750	.60	659	94.50.775	.60	631	94.50.750						

\*upon request



Trough (Part No. 94.30 and 94.31)  
with reinforced mounting angles for  
very rugged and extreme applications



For the following  
E-Chains®/E-Tubes:

**System E4 Series**

- 5050/5150/R9850
- 5050HD/R9850HD
- 50/51/R98 classic
- 15050/15150/R19850
- 150/151/R198 classic

**System E6 Series**

- E6.80/E6.80L



**Fixed end module**

Quick installation of the mounting brackets due to the prepared bores

▶ page 9.62

- $B_a$  = Outer E-Chain® width
- $B_i$  = Inner E-Chain® width
- $h_a$  = E-Chain® outer height
- $H_{Ri}$  = Inner trough height
- $H_{Ra}$  = Outer trough height
- $B_{Ri}$  = Inner trough width ▶ depends on dim.  $B_a$
- $B_{Ra}$  = Outer trough width
- $n_{Mon}$  = Number of installation sets (left/right)
- $n_{Ri}$  = Number of trough sets (left/right)
- !  $H_{Ri} \geq 2 \cdot h_a$
- !  $B_{Ri} \geq B_a + 5$
- = Guide trough
- = Glide bar
- = Installation set
- = C-profile

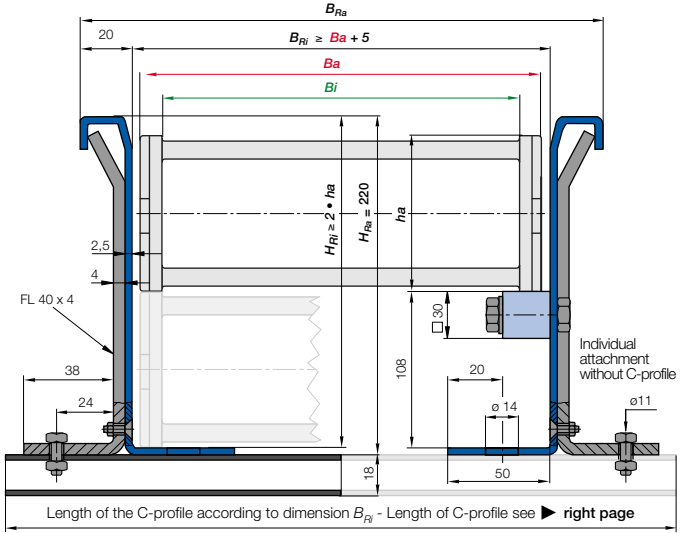

**Steel Guide Trough components - Sets and single parts**

Complete guide trough sets - description	Part No.	Weight	kg
Set of 2 trough side parts <b>without</b> glide bars, 2 m section	96.30	≈ 22,80 kg	
Set of 2 trough side parts <b>with</b> glide bars, 2 m section	96.31	≈ 27,20 kg	
1 Installation set "Basic" with C-profile	96.50. <input type="text"/>		
1 Installation set "Basic" without C-profile	96.50	≈ 0,72 kg	
Single parts - description			
1 glide bar, individual, each 2 m	93.01	≈ 1,68 kg	
1 glide bar, individual, each 2 m + 11 screw sets	93.20	≈ 2,22 kg	
11 screw sets for 2 m sections	93.21	≈ 0,54 kg	
1 Clamping bracket, individual	96.51	≈ 0,31 kg	
1 Countersunk-head screw M6 x 14, individual	92.53		
1 Hexagon nut M6, individual	92.54		
1 Hexagon-head screw M10 x 16, individual	92.55		
1 Glide nut M10, individual	92.56		
1 C-profile, individual	92.52. <input type="text"/>	≈ 0,90 kg/m	

Supplement Part No. with the indicated C-profile-length-index. Example: 96.50.

C-profile-length-index for your chosen trough inner width  $B_{Ri}$  ▶ right table

Trough side parts also available in stainless steel. Please add index "E" to the Part No. 96.30.E

**Principle sketch: Number of installation sets which have to be installed**

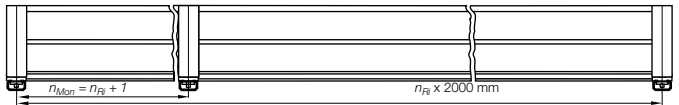

Calculation - travel center mounted

Half travel length, rounded down to full 2 m sections = X m guide trough length without glide bars + X m guide trough length with glide bars + installation sets (number of trough pieces + 1)



Order example: Length of travel 30 m - Center mounted for Series 5050.05 with  $B_{Ri} = 105$

Guide trough-set of 2 trough side parts, <b>without</b> glide bars:	
16 m Guide trough = 8 x 2 m sections (without glide bars)	Part No. 96.30
Guide trough-set of 2 trough side parts, <b>with</b> assembled glide bars:	
16 m Guide trough = 8 x 2 m sections (with glide bars)	Part No. 96.31
Installation sets complete (Guide trough-sets + 1)	
17 Installation sets (with C-profile)	Part No. 96.50. <input type="text"/>

## Part No. Installation set: Steel Guide Trough with C-profile (in dependence of the width)

5050/5150/R9850			5050HD/R9850HD			15050/15150/R19850			E6.80			E6.80L		
5050.10.200.0			5050HD.10.200.0			15050.07.225.0			E6.80.05.200.0			E6.80L.07.225.0		
$B_{Rl}$ [mm]	Part No. Installation set		$B_{Rl}$ [mm]	Part No. Installation set		$B_{Rl}$ [mm]	Part No. Installation set		$B_{Rl}$ [mm]	Part No. Installation set		$B_{Rl}$ [mm]	Part No. Installation set	
.05	105	96.50.225	.05	115	96.50.225	.05	85	*	.05	105	96.50.225	.11	145	96.50.275
.06	120	96.50.250	.06	130	96.50.250	.07	110	96.50.225	.06	120	96.50.250	.12	158	96.50.275
.07	130	96.50.250	.07	140	96.50.250	.10	135	96.50.250	.07	130	96.50.250	.13	170	96.50.300
.10	155	96.50.275	.10	165	96.50.275	.11	148	96.50.275	.10	155	96.50.275	.15	183	96.50.300
.11	168	96.50.300	.11	177	96.50.300	.12	160	96.50.275	.11	167	96.50.300	.16	195	96.50.325
.12	180	96.50.300	.12	190	96.50.300	.13	173	96.50.300	.12	180	96.50.300	.17	208	96.50.325
.13	193	96.50.325	.13	202	96.50.325	.15	185	96.50.300	.13	192	96.50.325	.18	220	96.50.350
.15	205	96.50.325	.15	215	96.50.325	.16	198	96.50.325	.15	205	96.50.325	.20	233	96.50.350
.16	218	96.50.350	.16	227	96.50.350	.17	210	96.50.325	.16	217	96.50.350	.21	245	96.50.375
.17	230	96.50.350	.17	240	96.50.350	.18	223	96.50.350	.17	230	96.50.350	.22	258	96.50.375
.18	243	96.50.375	.18	252	96.50.375	.20	235	96.50.350	.18	242	96.50.375	.23	270	96.50.400
.20	255	96.50.375	.20	265	96.50.375	.21	248	96.50.375	.20	255	96.50.375	.25	283	96.50.400
.21	268	96.50.400	.21	277	96.50.400	.22	260	96.50.375	.21	267	96.50.400	.26	295	96.50.425
.22	280	96.50.400	.22	290	96.50.400	.23	273	96.50.400	.22	280	96.50.400	.27	308	96.50.425
.23	293	96.50.425	.23	302	96.50.425	.25	285	96.50.400	.23	292	96.50.425	.28	320	96.50.450
.25	305	96.50.425	.25	315	96.50.425	.26	298	96.50.425	.25	305	96.50.425	.30	333	96.50.450
.26	318	96.50.450	.26	327	96.50.450	.27	310	96.50.425	.26	317	96.50.450	.31	345	96.50.475
.27	330	96.50.450	.27	340	96.50.450	.28	323	96.50.450	.27	330	96.50.450	.32	358	96.50.475
.28	343	96.50.475	.28	352	96.50.475	.30	335	96.50.450	.28	342	96.50.475	.33	370	96.50.500
.30	355	96.50.475	.30	365	96.50.475	.31	348	96.50.475	.30	355	96.50.475	.35	383	96.50.500
.31	368	96.50.500	.31	377	96.50.500	.32	360	96.50.475	.31	367	96.50.500	.36	395	96.50.525
.32	380	96.50.500	.32	390	96.50.500	.33	373	96.50.500	.32	380	96.50.500	.37	408	96.50.525
.33	393	96.50.525	.33	402	96.50.525	.35	385	96.50.500	.33	392	96.50.525	.38	420	96.50.550
.35	405	96.50.525	.35	415	96.50.525	.36	398	96.50.525	.35	405	96.50.525	.40	433	96.50.550
.36	418	96.50.550	.36	427	96.50.550	.37	410	96.50.525	.36	417	96.50.550	.41	445	96.50.575
.37	430	96.50.550	.37	440	96.50.550	.38	423	96.50.550	.37	430	96.50.550	.42	458	96.50.575
.38	443	96.50.575	.38	452	96.50.575	.40	435	96.50.550	.38	442	96.50.575	.43	470	96.50.600
.40	455	96.50.575	.40	465	96.50.575	.41	448	96.50.575	.40	455	96.50.575	.45	483	96.50.600
.41	468	96.50.600	.41	477	96.50.600	.42	460	96.50.575	.41	470	96.50.600	.46	495	96.50.625
.42	480	96.50.600	.42	490	96.50.600	.43	473	96.50.600	.42	480	96.50.600	.47	508	96.50.625
.43	493	96.50.625	.43	502	96.50.625	.45	485	96.50.600	.43	492	96.50.625	.48	520	96.50.650
.45	505	96.50.625	.45	515	96.50.625	.46	498	96.50.625	.45	505	96.50.625	.50	533	96.50.650
.46	518	96.50.650	.46	527	96.50.650	.47	510	96.50.625	.46	517	96.50.650	.51	545	96.50.675
.47	530	96.50.650	.47	540	96.50.650	.48	523	96.50.650	.47	530	96.50.650	.52	558	96.50.675
.48	543	96.50.675	.48	552	96.50.675	.50	535	96.50.650	.48	542	96.50.675	.53	570	96.50.700
.50	555	96.50.675	.50	565	96.50.675	.51	548	96.50.675	.50	555	96.50.675	.55	583	96.50.700
.51	568	96.50.700	.51	577	96.50.700	.52	560	96.50.675	.51	567	96.50.700			
.52	580	96.50.700	.52	590	96.50.700	.53	573	96.50.700	.52	580	96.50.700			
.53	593	96.50.725	.53	602	96.50.725	.55	585	96.50.700	.53	592	96.50.725			
.55	605	96.50.725	.55	615	96.50.725	.60	635	96.50.750	.55	605	96.50.725			
.60	655	96.50.775	.60	665	96.50.775				.60	655	96.50.775			

\*upon request



Trough (Part No. 96.30 and 96.31)  
with reinforced mounting angles for  
very rugged and extreme applications



For the following  
E-Chains®/E-Tubes:

**System E4 Series**

- 600/601/R608
- 640
- 1640/R1608



**Fixed end module**

Quick installation of the mounting brackets due to the prepared bores

► page 9.62

- $B_a$  = Outer E-Chain® width
- $B_i$  = Inner E-Chain® width
- $h_a$  = E-Chain® outer height
- $H_{Ri}$  = Inner trough height
- $H_{Ra}$  = Outer trough height
- $B_{Ri}$  = Inner trough width ► depends on dim.  $B_a$
- $B_{Ra}$  = Outer trough width
- $n_{Mon}$  = Number of installation sets (left/right)
- $n_{Ri}$  = Number of trough sets (left/right)
- !  $H_{Ri} \geq 2 \cdot h_a$
- !  $B_{Ri} \geq B_a + 5$
- = Guide trough
- = Guide bar
- = Installation set
- = C-profile

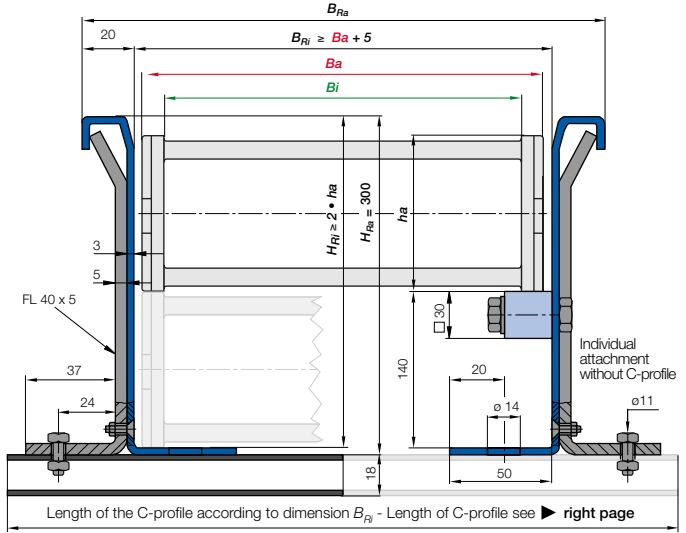

**Steel Guide Trough components - Sets and single parts**

Complete guide trough sets - description	Part No.	Weight	kg
Set of 2 trough side parts <b>without</b> glide bars, 2 m section	98.30	≈ 34,60 kg	
Set of 2 trough side parts <b>with</b> glide bars, 2 m section	98.31	≈ 39,00 kg	
1 Installation set "Basic" with C-profile	98.50. <input type="text"/>		
1 Installation set "Basic" without C-profile	98.50	≈ 1,16 kg	
Single parts - description			
1 glide bar, individual, each 2 m	93.01	≈ 1,68 kg	
1 glide bar, individual, each 2 m + 11 screw sets	93.20	≈ 2,22 kg	
11 screw sets for 2 m sections	93.21	≈ 0,54 kg	
1 Clamping bracket, individual	98.51	≈ 0,52 kg	
1 Countersunk-head screw M8 x 20, individual	92.05		
1 Hexagon nut M8, individual	92.04		
1 Hexagon-head screw M10 x 16, individual	92.55		
1 Glide nut M10, individual	92.56		
1 C-profile, individual	92.52. <input type="text"/>	≈ 0,90 kg/m	

Supplement Part No. with the indicated C-profile-length-index. Example: 98.50.

C-profile-length-index for your chosen trough inner width  $B_{Ri}$  ► right table

Trough side parts also available in stainless steel. Please add index "E" to the Part No. 98.30.E

**Principle sketch: Number of installation sets which have to be installed**

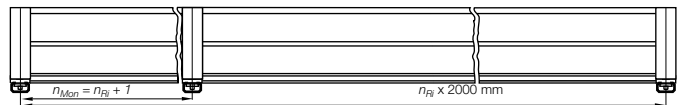

Calculation - travel center mounted

Half travel length, rounded down to full 2 m sections = X m guide trough length without glide bars + X m guide trough length with glide bars + installation sets (number of trough pieces + 1)



Order example: Length of travel 30 m - Center mounted for Series 600.20 with  $B_{Ri} = 257$

Guide trough-set of 2 trough side parts, <b>without</b> glide bars:		
16 m Guide trough = 8 x 2 m sections (without glide bars)	Part No.	98.30
Guide trough-set of 2 trough side parts, <b>with</b> assembled glide bars:		
16 m Guide trough = 8 x 2 m sections (with glide bars)	Part No.	98.31
Installation sets complete (Guide trough-sets + 1)	Part No.	98.50. <input type="text"/>
17 Installation sets (with C-profile)	Part No.	98.50. <input type="text"/>







For the following  
E-Chains®/E-Tubes:

System E4 Series

- 800
- 840

Führungsrinne mit verstärkten  
Montagewinkeln für die größten  
igus® E-Ketten® Serien 800 und  
840. Speziell für Großprojekte  
wie Krananlagen und Off-Shore



**Fixed end module**

Quick installation of the mounting  
brackets due to the prepared bores

▶ page 9.62

- $B_a$  = Outer E-Chain® width
- $B_i$  = Inner E-Chain® width
- $h_a$  = E-Chain® outer height
- $H_{Ri}$  = Inner trough height
- $H_{Ra}$  = Outer trough height
- $B_{Ri}$  = Inner trough width ▶  
depends on dim.  $B_a$
- $B_{Ra}$  = Outer trough width
- $n_{Mon}$  = Number of installation  
sets (left/right)
- $n_{Ri}$  = Number of trough  
sets (left/right)
- !  $H_{Ri} \geq 2 \cdot h_a$
- !  $B_{Ri} \geq B_a + 5$
- = Guide trough
- = Glide bar
- = Installation set
- = C-profile

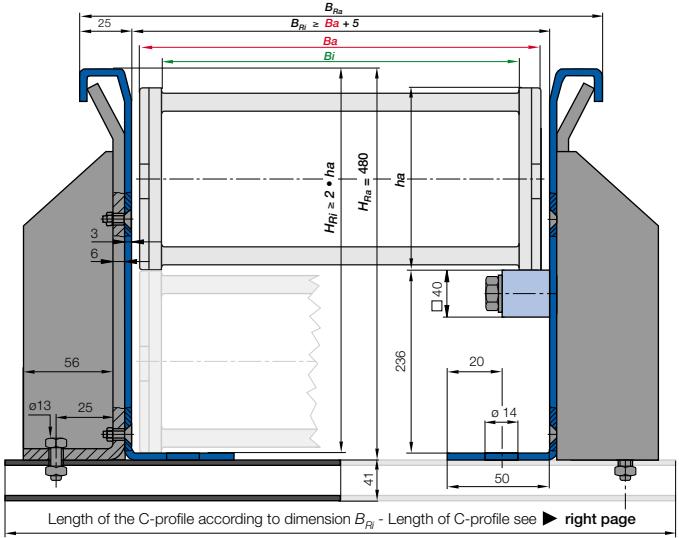

**Steel Guide Trough components - Sets and single parts**

Complete guide trough sets - description	Part No.	Weight	kg
Set of 2 trough side parts <b>without</b> glide bars, 2 m section	90.30	≈ 53,40 kg	
Set of 2 trough side parts <b>with</b> glide bars, 2 m section	90.31	≈ 59,40 kg	
1 Installation set "Basic" with C-profile	90.50. <input type="text"/>		
1 Installation set "Basic" without C-profile	90.50	≈ 0,41 kg	
Single parts - description			
1 glide bar, individual, each 2 m	90.01	≈ 3,00 kg	
1 glide bar, individual, each 2 m + 11 screw sets	90.20	≈ 3,50 kg	
11 screw sets for 2 m sections	90.21	≈ 0,50 kg	
1 Clamping bracket, individual	90.51	≈ 2,75 kg	
2 Countersunk-head screws M8 x 25, individual	92.53		
2 Hexagon nuts M8, individual	92.54		
1 Hexagon-head screw M12 x 30, individual	92.55		
1 Glide nut M12, individual	92.56		
1 C-profile, individual	92.52. <input type="text"/>	≈ 0,90 kg/m	

Supplement Part No. with the indicated C-profile-length-index. Example: 90.50.

C-profile-length-index for your chosen trough inner width  $B_{Ri}$  ▶ right table

Trough side parts also available in stainless steel. Please add index "E" to the Part No. 90.30.E

**Principle sketch: Number of installation sets which have to be installed**

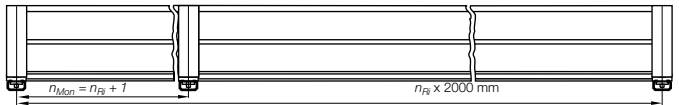

Calculation - travel  
center mounted

Half travel length, rounded down  
to full 2 m sections = X m guide  
trough length without glide bars  
+ X m guide trough length with  
glide bars + installation sets  
(number of trough pieces + 1)



Order example: Length of travel 30 m -  
Center mounted for Series 800.20.325.0 with  $B_{Ri} = 265$

Guide trough-set of 2 trough side parts, <b>without</b> glide bars:		
16 m Guide trough = 8 x 2 m sections (without glide bars)	Part No. 90.30	
Guide trough-set of 2 trough side parts, <b>with</b> assembled glide bars:		
16 m Guide trough = 8 x 2 m sections (with glide bars)	Part No. 90.31	
Installation sets complete (Guide trough-sets + 1)		
17 Installation sets (with C-profile)	Part No. 90.50. <input type="text" value="450"/>	



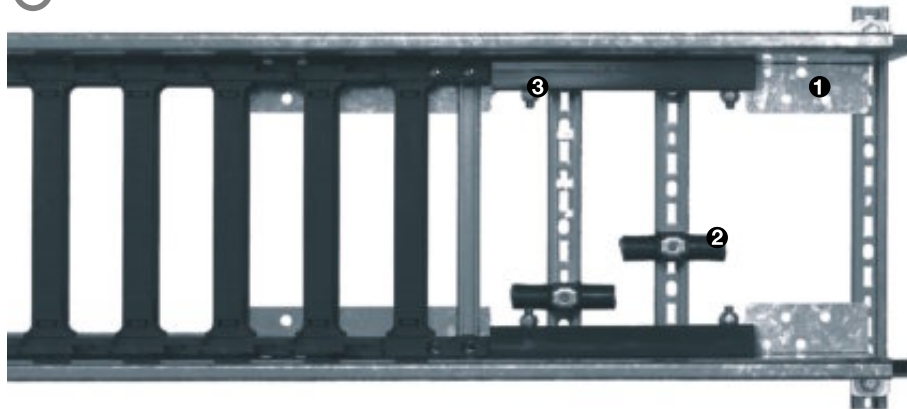

### New! Fixed end module for steel guide troughs

Until now, the steel trough had to be modified on site to fit the mounting brackets at the stationary end of the E-Chain®. That is now history. With its prefabricated boreholes, the 2.000 mm long kit can be used for middle-feed, end-feed and opposed installation.

- ① Fast fixation of mounting brackets  
thanks to prefabricated boreholes
- ② Fast installation of C-profile for strain relief
- ③ Fast bolting of glide bars
- Available immediately for Part No.  
93.80.01, 94.80.01 and 96.80.01

**Industries:** Power plants, coal conveyors, mining, composting plants, raw material storage, gipsimplants, etc.



Part No.	For Steel guide troughs	For Series
90.80.01	90.30 / 90.31	800 / 840
92.80.01*	92.30 / 92.31	2400 / 2500 / 2450 / 2480 / 255 / E6.29 / R6.29
93.80.01	93.30 / 93.31	3400 / 3450 / 3480 / 3500 / R68 / 380 / 390 / R780 / 3838 / 3938 / R7838 / 38 / 39 / E6.52 / R6.52
94.80.01	94.30 / 94.31	400 / 410 / R880 / 4040 / 4140 / R8840 / 14040 / 14140 / R18840 / 14240 / 14340 / E6.62
95.80.01*	95.30 / 95.31	2600 / 2650 / 2680 / 2700
96.80.01	96.30 / 96.31	5050 / 5150 / R9850 / 15050 / 15150 / R19850 / E6.80 / E6.80L
97.80.01*	97.30 / 97.31	280 / 290 / R770 / 2828 / 2928 / R7728 / E6.40
98.80.01*	98.30 / 98.31	600 / 601 / R608 / 640 / 1640 / R1608
99.80.01*	99.30 / 99.31	220 / R760

\*available upon request - time of delivery 6 weeks after intake of order

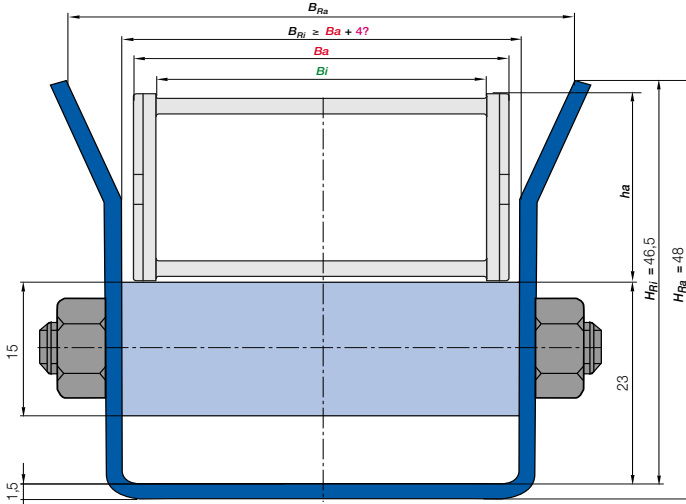

For the following E-Chains®/E-Tubes:

- System E2 Series**
- 10 ● 10 classic
- B15 ● B15 classic
- System Zipper Series**
- 15/R15 ● 15 classic



For Series 10, 15 and B15 are steel guide troughs for one side available. They have got a continuous glide bar for the transition from area with the glide bars to the area without glide bars. Available from stock are the guide troughs for the E-Chains® with an outer width up to 60 mm. For the E-Chains® with a width of more than 60 mm special solutions are on short call. For this trough sizes are no installation sets necessary as the guide troughs are made of a single U-profile. The solution for the trough joint is specific for every application.

- B<sub>a</sub>** = Outer E-Chain® width
- B<sub>i</sub>** = Inner E-Chain® width
- h<sub>a</sub>** = E-Chain® outer height
- H<sub>Ri</sub>** = Inner trough height
- H<sub>Ra</sub>** = Outer trough height
- B<sub>Ri</sub>** = Inner trough width
- B<sub>Ra</sub>** = Outer trough width

For Series	Part No.	Dim. B <sub>Ra</sub> [mm]	Dim. B <sub>Ri</sub> [mm]	Weight
<b>For Series 10.015/15.015/B15.015</b>				
Trough without glide bar, 2-m section	91.10	40,5	30	1,50 kg/m
Trough with glide bar, 2-m section	91.11	40,5	30	2,10 kg/m
<b>For Series 10.025/15.025/B15.025</b>				
Trough without glide bar, 2-m section	91.20	50,5	40	1,65 kg/m
Trough with glide bar, 2-m section	91.21	50,5	40	2,35 kg/m
<b>For Series 10.038/15.038/B15.038</b>				
Trough without glide bar, 2-m section	91.30	62,5	52	1,80 kg/m
Trough with glide bar, 2-m section	91.31	62,5	52	2,70 kg/m
<b>For Series 10.050/15.050/B15.050</b>				
Trough without glide bar, 2-m section	91.40	72,5	62	1,90 kg/m
Trough with glide bar, 2-m section	91.41	72,5	62	3,15 kg/m
<b>For Series 10.5/15.5/B15.5</b>				
Trough without glide bar, 2-m section	91.50	89,5	79	2,15 kg/m
Trough with glide bar, 2-m section	91.51	89,5	79	4,30 kg/m
<b>For Series 10.6/15.6/B15.6</b>				
Trough without glide bar, 2-m section	91.60	106,5	96	≈ 2,40 kg/m
Trough with glide bar, 2-m section	91.61	106,5	96	≈ 4,60 kg/m
<b>For Series 10.7/15.7/B15.7</b>				
Trough without glide bar, 2-m section	91.70	126,5	116	≈ 2,80 kg/m
Trough with glide bar, 2-m section	91.71	126,5	116	≈ 5,20 kg/m

**Order example: Length of travel 30 m - Center mounted for Series 10.038.100.0 with B<sub>Ri</sub> = 52**

Guide trough-channel without glide bars:	
10 m Guide trough = 5 x 2 m sections (without glide bars)	<b>Part No. 91.30</b>
Guide trough-channel with glide bars:	
10 m Guide trough = 5 x 2 m sections (with glide bars)	<b>Part No. 91.31</b>





# Further troughs

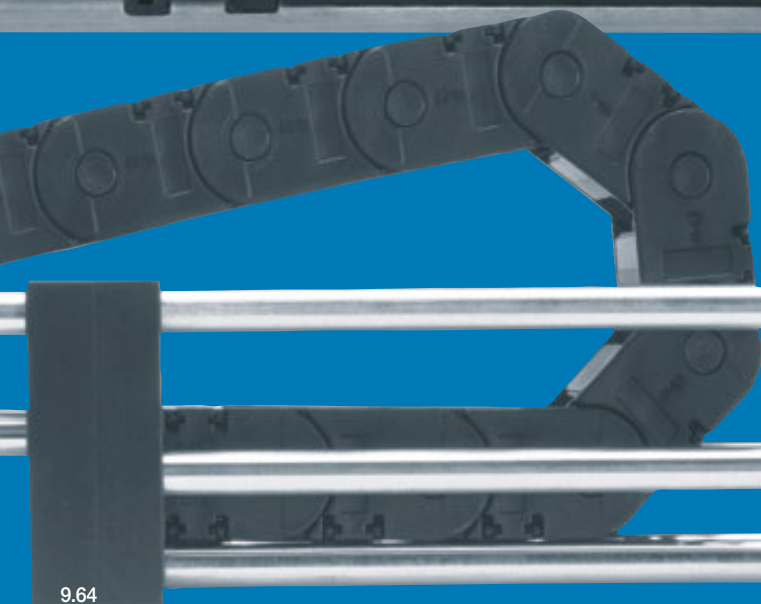

## Economically priced and simple guide options

igus® tubular trough and insert trough systems are simple and favorably priced options to safely guide E-Chains®. Recommended for less demanding applications and applications with travel speeds below 2 m/s, as well as travel distances below 50 m. The igus® tubular trough is ideal for applications where quick cleaning and good visibility are required. The crucial advantage of the igus® insert trough is the low price and the very simple and fast installation.

### Tubular trough system RS - lets light and dirt through

- Resistant to dirt - wear debris falls through
- More translucent than sheet metal constructions
- Easy and fast assembly
- Low price
- Easy and space saving delivery
- iF-Design Award

**Tubular troughs** ► from page 9.66

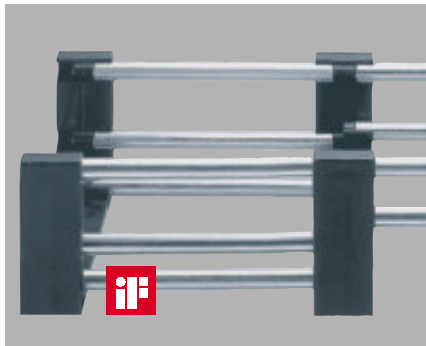

### Snap-in trough system SP - simple and cost effective

- Smaller than conventional troughs
- Easy and fast assembly
- No sharp metal edges in the internal area because of covered connectors
- Low price because of easy assembly

**Snap-in troughs** ► from page 9.68







The adjacent picture shows the transition from area without glide bar to area with glide bar in detail



## Tubular trough system RS - low priced guide trough solution

The Tubular Trough System RS enables the setting up of a guide trough through simply connecting the polymer tubes and installation elements. This system is used practically everywhere in mechanical engineering where elegant design is important and where no great mechanical loads are present. The System RS is a good choice particularly where dirt, chips occur, because the waste products simply fall through the spaces and are hence not relevant as possible disturbance factors. The tubes are available in galvanized steel or polymer.

The assembly of the guide trough is very simple, because the individual elements are not screwed together but, instead, only pushed together and

clipped in. The difficult setting of the correct width is no longer necessary, since fitting spacers are delivered with the complete order. ● **The junction installation set** is required for junction of area without glide bar to area with glide bar ● **The fastening set (Part No. 92.70 and Part No. 92.71)** is used for fastening the fixed point of the above-mentioned E-Chain® in the trough. It consists of 2 clamping parts which connect the end element (Material igumid G) **without** glide bar ❶ Installation set (Material igumid G) **with** glide bar ❷ Installation set (Material igumid G) **with** glide bar ❸ Installation set of junction of area ❹ Tubular steel  $\varnothing 12 \times 1$ , (galvanized)

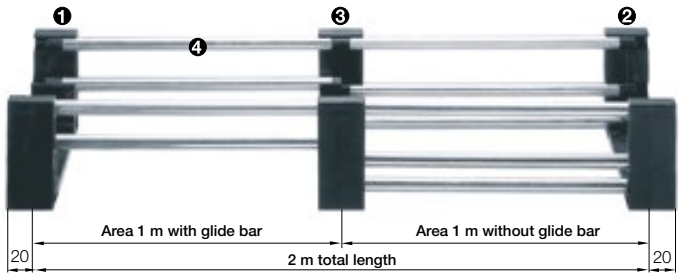

For the following E-Chains®/E-Tubes:

**System E2 Series**

- 2400/2450/2480/2500
- 255
- 200/240/250 classic

**System E6 Series**

- E6.29/R6.29\*

XX	Bi	Ba	B <sub>Ra</sub>	B <sub>Ri</sub>
02*	25	41	81	45
03	38	54	94	58
05	57	73	113	77
07	77	93	133	97
09	89	105	145	109
10	103	119	159	123
12	125	141	181	145

XX = E-Chain® width

\* without spacer plate

### Part No. 92.70 and Part No. 92.71

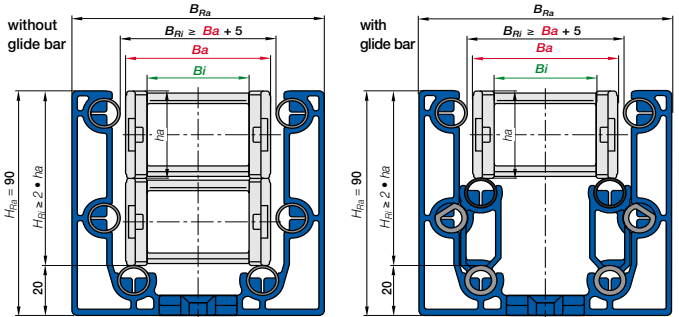

Tubular Trough Components	Part No.	Weight [kg]
Installation set <b>without</b> glide bars	92.70. XX	≈ 0,15
Installation set <b>with</b> glide bars	92.71. XX	≈ 0,12
Installation set junction	92.74. XX	
Fastening set	92.77.2	
Tubular steel, diameter 12 x 1 galvanized; (L = 985) for clearance Installation set 1 m	92.80	≈ 0,28

Supplement Part No. with the required width in the table. Example: 92.71. 10



Order Example: Inner width 57 mm. For 8 m trough the following parts are required:

Area <b>with</b> glide bar:	4 x Installation set Part No. 92.71.05 + tube: 4 x 4 piece Part No. 92.80
Area <b>without</b> glide bar:	4 x Installation set Part No. 92.70.05 + tube: 4 x 6 piece Part No. 92.80
	1 x junction Part No. 92.74.05

## Part No. 93.70 and Part No. 93.71

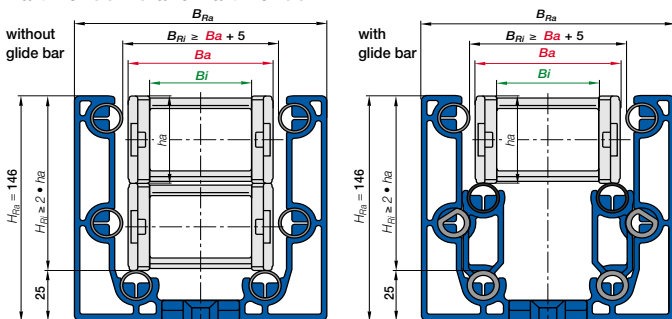

Tubular Trough Components	Part No.	Weight [kg]
Installation set <b>without</b> glide bars	93.70. <b>XX</b>	≈ 0,25
Installation set <b>with</b> glide bars	93.71. <b>XX</b>	≈ 0,20
Installation set junction	93.74. <b>XX</b>	
Tubular steel, diameter 12 x 1 galvanized; (L = 985) for clearance Installation set 1 m	93.80	≈ 0,50

Supplement Part No. with the required width in the table. Example: 93.71. **050**

**Order Example:** Inner width 50 mm. For 8 m trough the following parts are required:

Area <b>with</b> glide bar:	4 x Installation set Part No. 93.71.050 + tube: 4 x 4 piece Part No. 93.80
Area <b>without</b> glide bar:	4 x Installation set Part No. 93.70.050 + tube: 4 x 6 piece Part No. 93.80 1 x junction Part No. 93.74.050

For the following E-Chains\*/E-Tubes:

System E2 Series
● 3400/3450/3480/3500
● 340/350 classic
System E6 Series
● E6.52* ● R6.52*

XX	B <sub>i</sub>	B <sub>a</sub>	B <sub>Ra</sub>	B <sub>Ri</sub>
050	50	70	130	75
075	75	95	155	100
100	100	120	180	125
115	115	135	195	140
125	125	145	205	150
150	150	170	230	175
175	175	195	255	200
200	200	220	280	225
225	225	245	305	250
250	250	270	330	275

**XX** = E-Chain\* width  
\* without spacer plate

For 1 m trough without glide bars  
6 tubes 1 meter long are required.  
For 1 m trough with glide bars 4  
tubes 1 meter long are required.

## Part No. 95.70 and Part No. 95.71

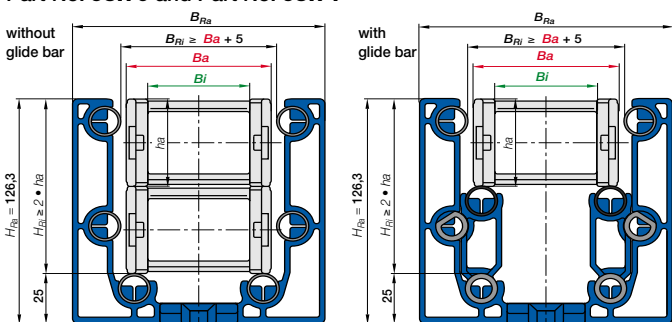

Tubular Trough Components	Part No.	Weight [kg]
Installation set <b>without</b> glide bars	95.70. <b>XX</b>	≈ 0,15
Installation set <b>with</b> glide bars	95.71. <b>XX</b>	≈ 0,12
Installation set junction	95.74. <b>XX</b>	
Fastening set	93.80	≈ 0,50

Tubular steel, diameter 12 x 1 galvanized; (L = 985) for clearance Installation set 1 m  
Supplement Part No. with the required width in the table. Example: 95.71. **10**

**Order Example:** Inner width 50 mm. For 8 m trough the following parts are required:

Area <b>with</b> glide bar:	4 x Installation set Part No. 95.71.05 + tube: 4 x 4 piece Part No. 93.80
Area <b>without</b> glide bar:	4 x Installation set Part No. 95.70.05 + tube: 4 x 6 piece Part No. 93.80 1 x junction Part No. 95.74.05

For the following E-Chains\*/E-Tubes:

System E2 Series
● 2600/2650/2680/2700
● 26/27/27i classic

XX	B <sub>i</sub>	B <sub>a</sub>	B <sub>Ra</sub>	B <sub>Ri</sub>
05	50	66	124	71
06*	65	81	139	86
07	75	91	149	96
09*	90	106	164	111
10	100	116	174	121
12	125	141	199	146
15	150	166	224	171
17	175	194	252	199
20	200	219	277	224

**XX** = E-Chain\* width

For 1 m trough without glide bars  
6 tubes 1 meter long are required.  
For 1 m trough with glide bars 4  
tubes 1 meter long are required.





The spacer plate makes the trough installation easier because it is no longer necessary to set the trough width

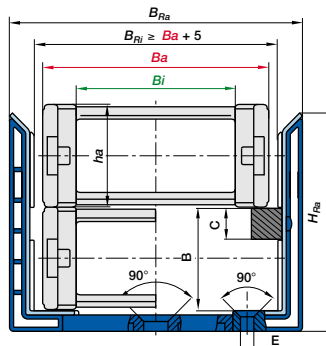

For the following  
E-Chains®/E-Tubes:

**System E2 Series**

- 10
- B15/B15i
- Zipper Series
- 15

**Part No. 91.930**

**Snap-In Trough Components**

- Trough set **without** glide bars, 2 glide strips of 1 m
- Trough set **with** glide bars, 2 glide strips of 1 m
- Glide bar set, 2 glide bars, 1 m section
- Screw set
- Installation set **with** spacer plate
- Installation set **without** spacer plate

Part No. Weight

Trough	[kg/m]
91.930	≈ 1,50
91.931	≈ 1,90
91.920	
91.921	
91.950. <b>XX</b>	≈ 0,05
91.950	≈ 0,03

Supplement Part No. with the required width in the table. Example: 91.950. **05**

<b>XX</b>	$H_{Ra}$	B	C	$B_{Ri}$	D	ø E	$B_{Ra}$
015	55,5	23	12	29,6	21	4,2	46
025	55,5	23	12	39,6	31	4,2	56
038	55,5	23	12	51,6	43	4,2	68
050	55,5	23	12	63,6	55	4,2	80
05	55,5	23	12	79,6	71	4,2	96
06	55,5	23	12	96,6	88	4,2	113
07	55,5	23	12	116,6	108	4,2	133



For the following  
E-Chains®/E-Tubes:

**System E2 Series**

- 2400/2450/2480/2500
- 200/240/250 classic

**System E6 Series**

- E6.29 ● R6.29

(without spacer plate)

**Part No. 92.930**

**Snap-In Trough Components**

- Trough set **without** glide bars, 2 glide strips of 2 m
- Trough set **with** glide bars, 2 glide strips of 2 m
- Glide bar set, 2 glide bars, 2 m section
- Screw set
- Installation set **with** spacer plate
- Installation set **without** spacer plate

Part No. Weight

Trough	[kg/m]
92.930	≈ 5,50
92.931	≈ 6,50
92.920	
92.921	
92.950. <b>XX</b>	≈ 0,10
92.950	≈ 0,08

Supplement Part No. with the required width in the table. Example: 92.950. **05**

<b>XX</b>	$H_{Ra}$	B	C	$B_{Ri}$	D	ø E	$B_{Ra}$
02*	76,6	35	15	43	14	6,6	67
03	76,6	35	15	56	27	6,6	80
05	76,6	35	15	75	46	6,6	99
07	76,6	35	15	95	66	6,6	119
09	76,6	35	15	107	78	6,6	131
10	76,6	35	15	121	92	6,6	145
12	76,6	35	15	143	114	6,6	167

**XX** = E-Chain\* width

\* without spacer plate



**Order Example - for 20 m trough Part. No. 93.930**  
the following parts are required::

10 m Part No. 93.930, Trough set without glide bars (5 x 2 m)

10 m Part No. 93.931, Trough set with glide bars (5 x 2 m)

Part No. 93.950. 050, Installation set

$B_a$  = Outer E-Chain\* width  
 $B_i$  = Inner E-Chain\* width  
 $h_a$  = E-Chain\* outer height  
 $H_{Ri}$  = Inner trough height  
 $H_{Ra}$  = Outer trough height  
 $B_{Ri}$  = Inner trough width ►  
 depends on dim.  $B_a$   
 $B_{Ra}$  = Outer trough width

Part No. 93.930	Part No.	Weight
<b>Snap-In Trough Components</b>	<b>Trough</b>	<b>[kg/m]</b>
Trough set <b>without</b> glide bars, 2 glide strips of 2 m	93.930	≈ 9,00
Trough set <b>with</b> glide bars, 2 glide strips of 2 m	93.931	≈ 10,00
Glide bar set, 2 glide bars, 2 m section	93.920	
Screw set	93.921	
Installation set <b>with</b> spacer plate	93.950. <span style="border: 1px solid black; padding: 0 2px;">XX</span>	≈ 0,20
Installation set <b>without</b> spacer plate	93.950	≈ 0,16

Supplement Part No. with the required width in the table. Example: 93.950. 050

<span style="border: 1px solid black; padding: 0 2px;">XX</span>	$H_{Ra}$	B	C	$B_{Ri}$	D	ø E	$B_{Ra}$
050	138,6	64	15	74	40	6,6	102
075	138,6	64	15	99	65	6,6	127
100	138,6	64	15	124	90	6,6	152
115	138,6	64	15	139	105	6,6	167
125	138,6	64	15	149	115	6,6	177
150	138,6	64	15	174	140	6,6	202
175	138,6	64	15	199	165	6,6	227
200	138,6	64	15	224	190	6,6	252
225	138,6	64	15	249	215	6,6	277
250	138,6	64	15	274	240	6,6	302

For the following  
E-Chains\*/E-Tubes:

**System E2 Series**

● 3400/3450/3480/3500

● 340/350 classic

**System E6 Series**

● E6.52 ● R6.52

(without spacer plate)

Art. Nr. 95.930	Part No.	Weight
<b>Snap-In Trough Components</b>	<b>Trough</b>	<b>[kg/m]</b>
Trough set <b>without</b> glide bars, 2 glide strips of 2 m	95.930	≈ 7,10
Trough set <b>with</b> glide bars, 2 glide strips of 2 m	95.931	≈ 8,10
Glide bar set, 2 glide bars, 2 m section	95.920	
Screw set	95.921	
Installation set <b>with</b> spacer plate	95.950. <span style="border: 1px solid black; padding: 0 2px;">XX</span>	≈ 0,11
Installation set <b>without</b> spacer plate	95.950	≈ 0,13

Supplement Part No. with the required width in the table. Example: 95.950. 05

<span style="border: 1px solid black; padding: 0 2px;">XX</span>	$H_{Ra}$	B	C	$B_{Ri}$	D	ø E	$B_{Ra}$
05	106,6	50	15	70	40	6,6	94
06*	106,6	50	15	85	55	6,6	109
07	106,6	50	15	95	65	6,6	119
09*	106,6	50	15	110	80	6,6	134
10	106,6	50	15	120	90	6,6	144
12	106,6	50	15	145	115	6,6	169
15	106,6	50	15	170	140	6,6	194
17	106,6	50	15	198	168	6,6	222
20	106,6	50	15	223	193	6,6	247

For the following  
E-Chains\*/E-Tubes:

**System E2 Series**

● 2600/2650/2680/2700

● 26/27/27i classic

XX = E-Chain\* width

\* without spacer plate

Phone +49- (0) 22 03-96 49-800  
Fax +49- (0) 22 03-96 49-222

AL

ST

RS

SP

# Special Solutions for Long Travels



**System AUTO-GLIDE** | Long travels without guide troughs

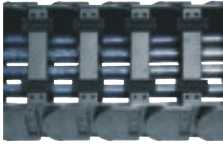

**AUTO-GLIDE**  
▶ from page 9.72

Product	Page
<b>AUTO-GLIDE</b>	
Self-guiding E-ChainSystems® - No Guide Troughs required!	
Travels up to 50 m, speeds up to 1,5 m/s	9.72

**RoI E-Chain®** | Rolling instead of gliding



**RoI E-Chain®**  
▶ from page 9.78

Product	Page
<b>RoI E-Chain®</b>	
Major reduction in drive power to less than 25 % for moving the E-Chain®	
Travels up to 800 m, speeds up to 10 m/s	9.78

**LBT Flizz®** | Enclosed plastic trough



**LBT Flizz®**  
▶ from page 9.82

Product	Page
<b>LBT Flizz®</b>	
Modular guide trough construction kit	
Travels up to 200 m, speeds up to 8 m/s	9.82

**Micro Flizz®** | Small E-Chains® in aluminum profile



**Micro Flizz®**  
▶ from page 9.86

Product	Page
<b>Micro Flizz®</b>	
ONE compact system for a secure guidance of power, data and air	
Maintenance-free alternative for busbar	9.86

**LeviChain** | Magnetic E-ChainSystem® - it "floats"

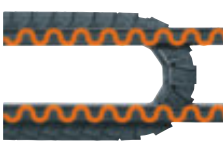

**LeviChain**  
▶ from page 9.92

Product	Page
<b>LeviChain</b>	
Long travel possible without laying the E-Chain® systems on top of each other	
Almost no abrasion and very low wear due to low-abrasion E-Chain® links (without pin/bore connection) as well as almost contactless movement of the E-Chain®	9.92

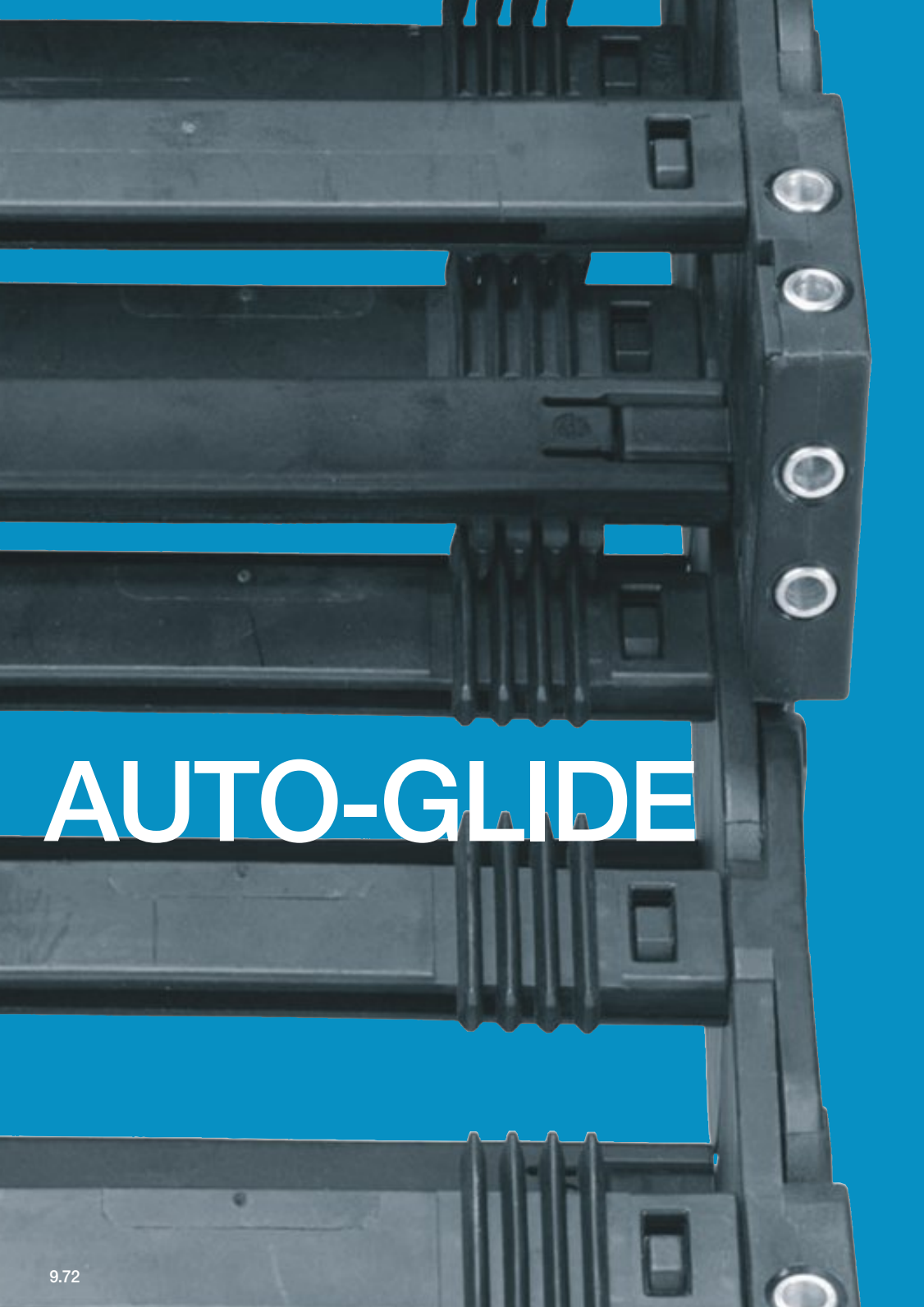

# AUTO-GLIDE



## AUTO-GLIDE:

Long travels are always demanding for an E-ChainSystem®. For much of the travel, the E-Chain must run on the lower run or on the glide bars. In addition the E-ChainSystem® needs guides, in order to prevent a sideward movement. In most cases this is ensured through a guide trough. However, there are also applications where a guide trough is not desired for space reasons, whether this is due to optical considerations or spatial conditions. In order to cater for this possibility, igus® developed the AUTO-GLIDE system in 1995. AUTO-GLIDE is a self-aligning E-Chain®, which can dispense with guide troughs for up to 100 m travel. You save acquisition and installation costs and can keep pathways in your warehouse free for lifts or industrial trucks.

- Travels up to 100 m
- Travel speeds up to 1,5 m/s
- AUTO-GLIDE E-Chain® links of a piece, no additional parts required
- Very quick installation times for long travels
- Guide troughs not required!
- Small installation width, silent operation
- Functional guarantee for the entire system with Chainflex® cables

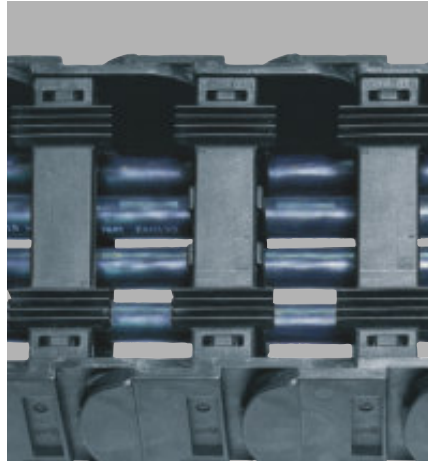

In principle every igus® E-Chain® can be fitted out for the AUTO-GLIDE system. However, we recommend its use with E-Chain® whose interior height is less than 35 mm, and you should also consult us, since there are restrictions regarding the bending radii to be used

There are 4 options of the igus® AUTO-GLIDE system:



Option 1 - is available for almost all System E4 Series - here the crossbars in the interior radius of the E-Chain® are fitted with molded-on glide shoes

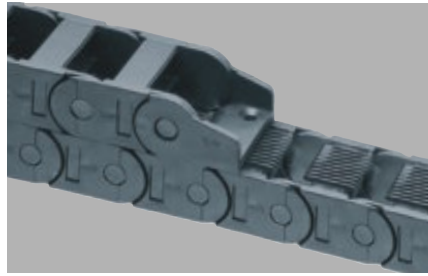

Option 2 - for Series 200 E-Chains®: Injection-molded AUTO-GLIDE grooves in the inner radius. One-piece E-Chain® with firmly molded horizontal interior separation

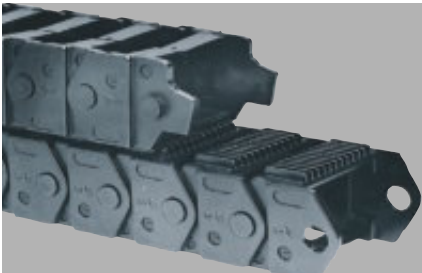

Option 3 - for igus® Easy Chain® E-Chain® combination of the easily fillable Easy Chain® and injection-molded AUTOGLIDE grooves in the inner radius

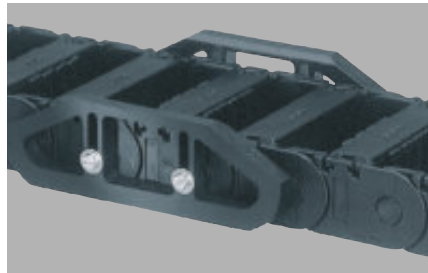

Option 4 - for Series E2/000 E-Chain® - Special plastic glide shoes side-mounted on the E-Chain® hold the E-Chain® "in the track"



Part No. structure

400.	20.	250.	0.	AG
------	-----	------	----	----



### Option 1: AUTO-GLIDE for System® E4 up to 80 mm interior height

Option 1 is available for the larger E-Chains® of System E4 - here the crossbars in the interior radius of the E-Chain® are fitted with molded-on glide shoes. With AUTO-GLIDE the length of the E-Chain® can be the entire travel plus add-on for the bending radius. However, it can still be assembled in the middle of the travel distance. In this case cost-effective glide strips are assembled for the other half.

### System E4 AUTO-GLIDE variants

Part No.		Bi	Ba	R	Bending radius															
280.20.	<input type="checkbox"/>	.0.AG	200	223	100	125	150	175	200	220	250	300								
2828.20.	<input type="checkbox"/>	.0.AG	200	223	100	125	150	175	200	220	250	300								
28.20.	<input type="checkbox"/>	.0.AG	200	223	100	125	150	175	200	220	250	300								
380.20.	<input type="checkbox"/>	.0.AG	200	226	100	115	125	150	170	200	115	250	300	350						
3838.20.	<input type="checkbox"/>	.0.AG	200	226	100	115	125	150	170	200	115	250	300	350						
38.20.	<input type="checkbox"/>	.0.AG	200	226	100	115	125	150	170	200	115	250	300	350						
400.15	<input type="checkbox"/>	.0.AG	150	184	135	150	175	200	240	250	300	350	400	500						
400.21	<input type="checkbox"/>	.0.AG	212	249	135	150	175	200	240	250	300	350	400	500						
400.25	<input type="checkbox"/>	.0.AG	250	284	135	150	175	200	240	250	300	350	400	500						
4040.15	<input type="checkbox"/>	.0.AG	150	184	135	150	175	200	240	250	300	350	400	500						
4040.21	<input type="checkbox"/>	.0.AG	212	249	135	150	175	200	240	250	300	350	400	500						
4040.25	<input type="checkbox"/>	.0.AG	250	284	135	150	175	200	240	250	300	350	400	500						
40.15	<input type="checkbox"/>	.0.AG	150	184	135	150	175	200	240	250	300	350	400	500						
40.21	<input type="checkbox"/>	.0.AG	212	249	135	150	175	200	240	250	300	350	400	500						
40.25	<input type="checkbox"/>	.0.AG	250	284	135	150	175	200	240	250	300	350	400	500						
5050.15	<input type="checkbox"/>	.0.AG	150	200	150	200	250	300	350	400	500	550	600	650	1000					
5050.21	<input type="checkbox"/>	.0.AG	121	263	150	200	250	300	350	400	500	550	600	650	1000					
5050.25	<input type="checkbox"/>	.0.AG	250	300	150	200	250	300	350	400	500	550	600	650	1000					
50.15	<input type="checkbox"/>	.0.AG	150	200	150	200	250	300	350	400	500	550	600	650	1000					
50.21	<input type="checkbox"/>	.0.AG	212	263	150	200	250	300	350	400	500	550	600	650	1000					
50.25	<input type="checkbox"/>	.0.AG	250	300	150	200	250	300	350	400	500	550	600	650	1000					

Supplement Part No. with required radius. Example: 280.20.150.0.AG

Further widths on request - Delivery time: approx. 6-8 weeks after receipt of order!

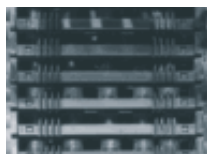

Large gliding surfaces and good sliding behavior - Of one piece, no additional parts required



A glider and floor guides every 2 m completely replace a guide trough

### Long travel without guide trough - Glider and floor guide

Simple guide elements for quick installation on the subsurface are available for the AUTO-GLIDE system version 1. The traversable eccentric floor guides are fastened every 2 m on the subsurface. The glider ② fastened on the moving end feeds the E-Chain® and holds this securely in the track. The AUTO-GLIDE crossbars ③ safely guide the E-Chain® and replace the guide trough. ● Save purchase and installation costs with this system ● Traversable over floor guide for travel distances over 10 m

Note: Only 2 gliders AG.XXX.OF are required for the safe feeding of the E-Chain®. The mounting of the glider is done on the outer link of the upper run, which is laid down first on the lower run.



Industrial trucks can run over the floor guides

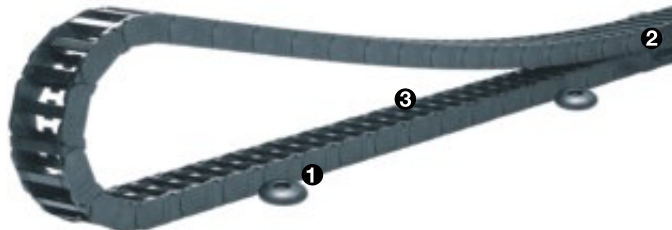

Part No. glider ②	For Series
AG.280.OF	280/2828/28/2822
AG.380.OF	380/3838/38/3822
Part No. floor guide ①	For Series
AG.380.BF	universal

### Roller AUTO-GLIDE RAG

Special feature: Series 4040 and 5050 also available as rolling AUTO-GLIDE. For long travel and 75% less drive power (gliding application). We request for a consultation in case you have decided on this product.



### System E4 Roller AUTO-GLIDE options

Part No.	Bi	Ba	R	Bending radius									
4040.28.	287	324	135	150	175	200	240	250	300	350	400	500	
4040.36.	362	399	135	150	175	200	240	250	300	350	400	500	
5050.28.	287	338	150	200	250	300	350	400	500	550	600	650	1000
5050.36.	362	413	150	200	250	300	350	400	500	550	600	650	1000

Supplement Part No. with required radius. Example: 4040.28.150.0.RAG

Comprehensive information for each E4 Series can be found at the relevant catalog page

Series	Inner-height <i>hi</i>	Outer-height <i>ha</i>	Page	Series	Inner-height <i>hi</i>	Outer-height <i>ha</i>	Page
280	32	54	7.26	400	56	84	7.46
2828	32	54	7.92	4040*	56	84	7.116
28	32	54	12.34	40	56	84	12.38
380	42	64	7.36	5050*	80	108	7.136
3838	42	64	7.104	50	80	108	12.40
38	42	64	12.36	*Also available as AUTO-GLIDE E-Chain*			

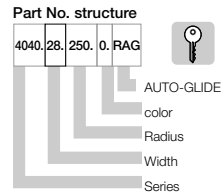

## AUTO-GLIDE | Product Range | Option 2

### Option 2: Series 200 - Molded AUTO-GLIDE grooves in the inner radius

One-piece E-Chain® with molded AUTO-GLIDE grooves in the inner radius. Available in one width, with molded horizontal interior separation.

- AUTO-GLIDE E-Chain® links are moulded and no additional parts are necessary
- Guide troughs not required!
- Narrow construction width, quiet running
- Function guarantee on the whole system with Chainflex® cables



### Series AG200 - Combination: AUTO-GLIDE and E2 medium (Series 200)

Part No.	Bi	Ba	R	Bending radius							
AG200.05.	57	73,2	055	075	100	125	150	175	200	225	250

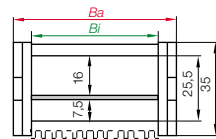

Supplement Part No. with required radius. Example: AG200.05.055.0

Pitch = 46 mm Links/m = 22 Chain length = S + K

R	055	075	100	125	150	175	200	225	250
H <sup>+</sup>	145	185	235	285	335	385	435	485	535
D	125	150	170	195	220	245	270	295	320
K	276	346	414	496	578	660	742	814	920

The required clearance height is:  $H_F = H + 25$  mm

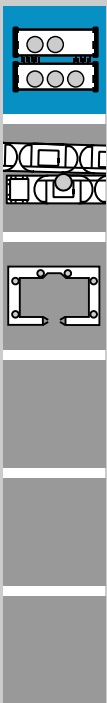
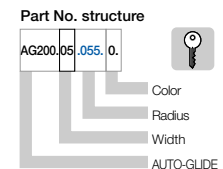



**Option 3: As EA16 and EA25**

The version 2 is a combination of AUTO-GLIDE version 1 and Easy Chain®. The grooves similar to tie-wrap plates are molded directly on the E-Chain® link and available at present in two sizes.

- AUTO-GLIDE E-Chain® links of a piece, no additional parts required
- Very quick installation times for long travels
- Guide troughs not required!
- Easy Chain® system: Cables and hoses can be inserted without opening the E-Chain®
- Small installation width, silent operation
- Functional guarantee for the entire system with Chainflex® cables

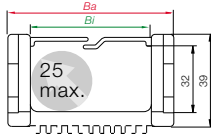

Part No. structure

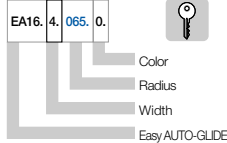

**Series EA16 - Combination of AUTO-GLIDE and Easy Chain®**

Part No.	Bi	Ba	R Bending radius
EA16.4. <input type="text"/> .0	48	60	<input type="text"/> 065 <input type="text"/> 075 <input type="text"/> 100

Supplement Part No. with required radius. Example: EA16.4. 065.0

Pitch = 30,5 mm    Links/m = 33    Chain length = S + K

R	065	075	100
H	159	189	239
D	110	130	155
K	270	305	395

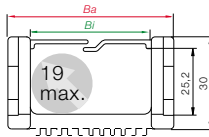

Part No. structure

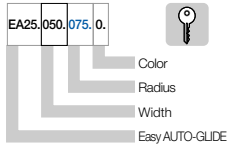

**Series EA25 - Combination of AUTO-GLIDE and Easy Chain®**

Part No.	Bi	Ba	R Bending radius
EA25.050. <input type="text"/> .0	50	60	<input type="text"/> 065 <input type="text"/> 075 <input type="text"/> 100

Supplement Part No. with required radius. Example: EA25.050. 075.0

Pitch = 25 mm    Links/m = 40    Chain length = S + K

R	063	075	100
H	156	180	230
D	125	135	160
K	250	290	375





# Rol E-Chain<sup>®</sup>



## Rol E-Chain® - Rolling instead of gliding

E-Chains® are being used in ever longer travels. This has driven the development of the Rol E-Chain®. Additionally, movement speeds are increasing in combination with larger and larger fill weights (up to 50 kg/m). **Please contact us if you have decided for this product. We'll assist you in the project planning!**

### 7 use of the Rol E-Chain®

- Major reduction in drive power to less than 25 % for moving the E-Chain®
- Travels up to 800 m possible
- Speeds up to 10 m/s possible
- Various roller types for optimum application adaption
- Can be used even in dirty environments
- Available as ready-to-fit, made-to-specifications system
- System guarantee for made-to-specifications systems

### Application areas

The igus® Rol E-Chain® is designed for applications where long travels at high speeds have to be realized. This is, for instance, frequently the case with moving camera systems or material handling systems, even in the case of slower applications in the crane sector or travelling plants the low friction values of the system allow cost-savings, since the drives can be considerably smaller.

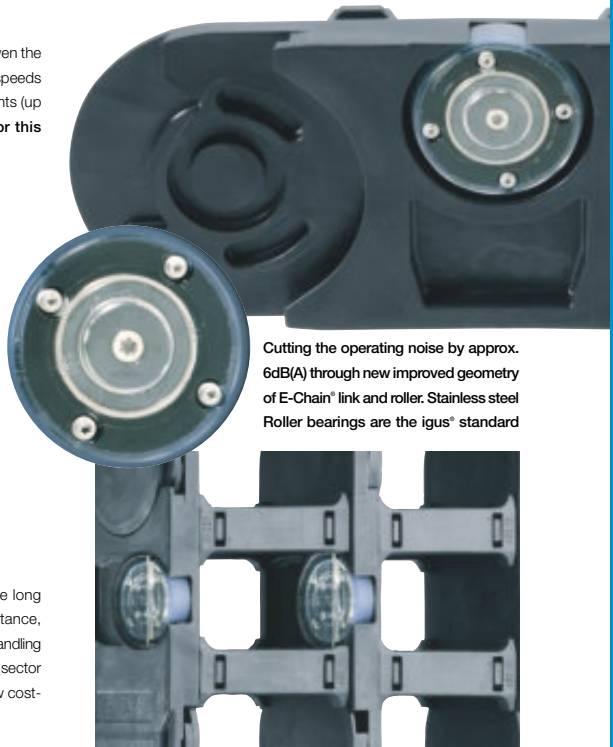

Cutting the operating noise by approx. 6dB(A) through new improved geometry of E-Chain® link and roller. Stainless steel Roller bearings are the igus® standard

Roller extension link for higher additional weights and widths up to 2 m and more



Cross travel of 441.3 m, implemented with igus® Rol E-Chain® Series 5050R



## Product Range Rol E-Chain®

Interior heights of 32, 42, 56 and 80 mm and widths of 50 mm up to several meters are possible and are available from stock. All interior separation options and mounting bracket variants of the igus® system E4 are available. The standard guide troughs of the relevant E-Chains® from stock can be used Rol E-Chains® can basically be opened along both radii. The Rol E-Chain® is available as a made-to-spec E-ChainSystem®. The Rol E-Chain® standard are stainless-steel ball-bearings. It is fitted with Chainflex® cables

and made-to-spec connectors and fittings in accordance with your requirements by igus® specialists and packaged in installation-friendly manner. Depending on the length of travel, the Rol E-Chain® can be delivered on a drum. If cables from the Chainflex® range are to be used, we will be more than willing to assume warranty for the full system. **Systems of this type should be designed by our system design engineers. We will be more than willing to submit an offer to you. Please contact us about this.**

### Selection table

Series	Inner height <i>hi</i> [mm]	Inner width <i>Bi</i> [mm]	Outer width <i>Ba</i> [mm]	Outer height <i>ha</i> [mm]	Bending radius <i>R</i> [mm]	Chapter
<b>Rol E-Chain® - with crossbars every 2<sup>nd</sup> link</b>						
2828R	32	50 - 400	73 - 423	54	125 - 300	7
3838R	42	50 - 400	77 - 427	64	150 - 350	7
4040R	56	50 - 600	86 - 636	84	200 - 500	7
4040 RHD*	56	50 - 600	140 - 654	84	200 - 500	7
5050R	80	50 - 600	100 - 650	108	250 - 500	7
5050 RHD*	80	50 - 660	160 - 710	108	200 - 500	7
<b>Rol E-Chain® - E-Tube, fully enclosed</b>						
R7728R	32	50 - 300	73 - 323	54	250 - 300	7
R7838R	42	50 - 300	77 - 327	64	200 - 350	7
R8840R	56	75 - 462	111 - 499	84	300 - 500	7
R9850R	80	75 - 462	125 - 513	108	300 - 1000	7

- 4040 RHD\* / 5050RHD\* = extra stable version of Series 4040 and 5050
- 5050R: for E-Chain® widths up to 3000 mm with extension link/roller extension link
- Series 2828R, 3838R, 4040R, 5050R are also available as AUTO-GLIDE rollers
- Details on the appropriate E4/4 Series ► chapter 7 - System E4/4

### Proven advantage: Reduce tensile strengths and shear forces by over 75% with igus® Rol E-Chain®

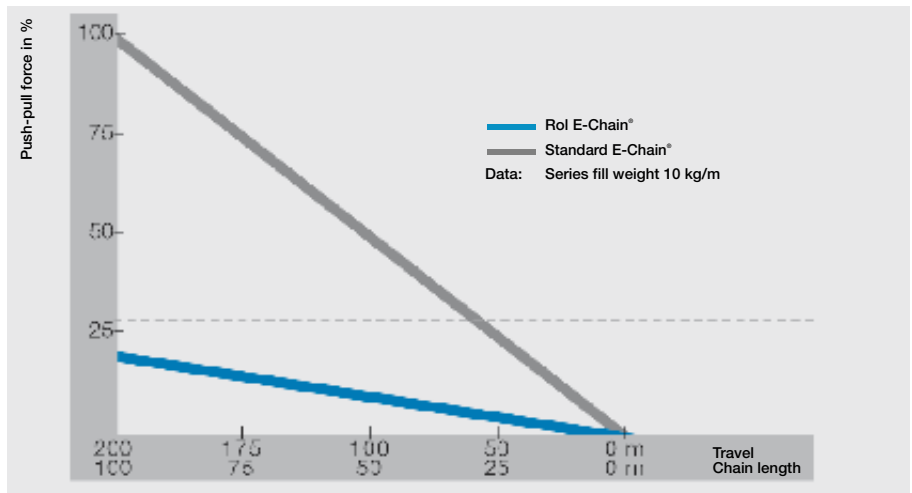

Comparison of the power requirement between Rol E-Chain® and a standard E-Chain®



igus® Rol E-Chain® Serie 5050R in a steel plant in India with highly corrosive atmosphere -  $s = 22 \text{ m}$ ,  $v = 1 \text{ m/s}$ ,  $a = 1 \text{ m/s}^2$



Power plant application with igus® Rol E-Chain® 4040R - Travel 46 m, Speed 1.5 m/s, Fill weight 5.3 kg/m



Assembled system in a ship unloading crane with igus® 5050RHD - Travel 106 m, Speed 4 m/s, Fill weight 25 kg/m



Series 4040R on a coal unloading system - Travel 190 m, Speed 0.5 m/s, Fill weight 8.05 kg/m



Series 4040R in steel works environment - Travel 10.5 m, Speed 60 m/min, Fill weight 6.084 kg/m



Special roller test bench for customer-specific test

Rol E-Chain®

Phone +49- (0) 22 03-96 49-800  
Fax +49- (0) 22 03-96 49-222



A close-up photograph of a black metal rail system, likely for a train or tram. The rails are connected by a black metal bracket with several horizontal slots. The background is a solid, bright blue. The text "LBT Flizz" is printed in white on the upper rail, with a registered trademark symbol (®) to its right.

LBT Flizz<sup>®</sup>

## LBT Flizz® - High speeds and accelerations

- Travels up to 200 m, speeds up to 8 m/s
- Applicable for moving and stationary control, ideal for all bus systems
- Good for applications needing low weight and good corrosion resistance
- Quiet and maintenance free operation
- At -35°C up to +80°C continuous temperature
- Accelerations over 10 m/s<sup>2</sup>
- Energy supply for all media, not only for electrical

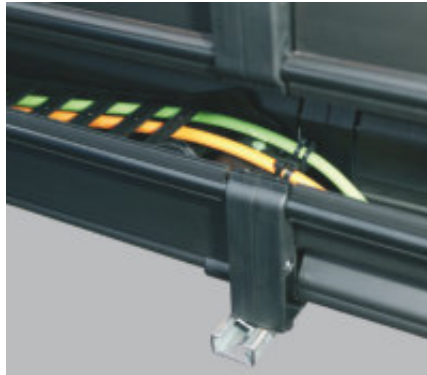

## LBT Flizz® System

The complete system comprises the igus® E-Chain®, the LBT Flizz® guide trough and the igus® Chainflex® cables which can be fully made-to-spec on request. The LBT Flizz® guide trough consists of a modular system, based on extruded guide profiles and a supporting frame with continuous tubes for stabilization. All components are of corrosion-protection, made either extruded or powder-coated high-quality plastic. The materials used are resistant to weathering and resistant to most chemicals, oils, greases, coolants and solvents. The optionally fully enclosed design offers protection against dirt, leaves, ice and snow. Safety, function and freedom from maintenance with clear price advantages over conventional energy supply systems are the crucial criteria for selection.

## Advantages of LBT Flizz®

- Guaranteed service life
- Cost-effective by comparison with conventional energy supply systems
- Protection of the cables against dirt, rain, sun, ice, snow and leaves (freezing not possible)
- Insensitive to wind movement
- Resistant to chemicals and solvents etc.
- Use of special cables possible, e.g. servo-drive cables, fiber-optic cables and bus systems etc.
- Virtually maintenance-free
- Easy and fast installation since it supplied as a made-to-spec system
- Easy integration in existing systems
- Cable length 50 % of travel

## Typical industries and applications

- Sludge scrapers
- Sand catchers
- Stormwater overflow tanks
- Electric plating plants
- Cranes
- Plant construction



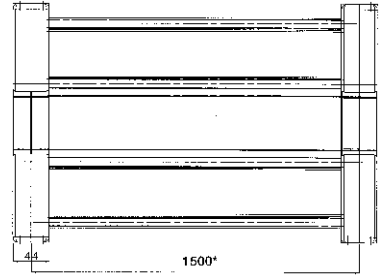
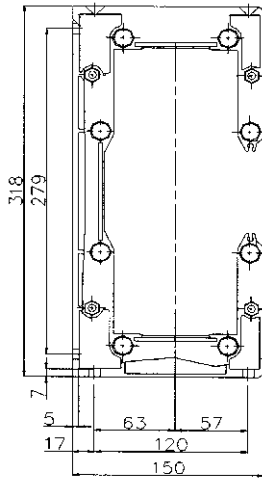
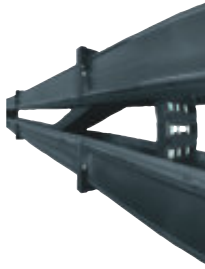

\*required length: 1500 mm (more upon request)

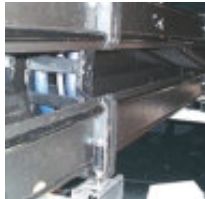
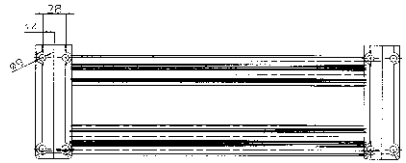

Installation variant for  
power feed at fixed end



Example of mounting  
the console on jibs



The installation variant of a floating moving end for compensating for any lateral offset tolerances between scraper and E-ChainSystem®

### Design

- Solid plastic with powder-coated support tubes
- Modular design: the system can be closed with intermediate plates!
- Can be supplied preassembled
- Variable bays which are simply screwed together
- Glide bar integrated in profile

### Safe energy and data transfer

The igus® Chainflex® range of cables offers a selection from over 750 different cables available from stock. This includes power, signal, data and bus systems including fibre optic cables. In addition, we can offer you all supply cables for your drive systems, such as motor, servo cables and encoder cables; all can be supplied made-to-spec with connectors.

### Cost-cutting installation

Thanks to the use of made-to-spec E-ChainSystems®, you can greatly reduce expensive time incurred for installation and assembly at the installation site. Function-tested systems guarantee fast commissioning of the powered system sections.

### Installation service

We will be more than pleased to submit an offer to you for a full solution, including all installation services. This means that none of your own staff are tied up and, in future, you will have a trouble-free energy supply system at a fixed price.







The scraper moves on the 38 m long final clarifier in round-the-clock operation. The energy supply is done via the LBT Flizz® system



Space-saving and compact energy supply with LBT Flizz® - Maintenance system, delivered pre-assembled with assembled igus® E-Chain®



LBT Flizz® in a longitudinal scraper travel (S) = 38 m

- Speed (v) = 1.0 m/min. ● Acceleration (a) = 0.5 m/s<sup>2</sup>
- Cycle time 1.5 x hour/ 24 h/365 days



Energy supply system protected from wind and weathering. The used materials are weather-resistant, as well as resistant against most chemicals, oils, fats, coolants and solvents



igus® LBT Flizz® - Sewage works of the company Hydrobudowa S.A. in Poland. The power supply system of the scrapers in 8 clarifiers was equipped with igus® E-Chain® and LBT Flizz®. The complete system runs directly over the clarifier. Advantages: ● Low-maintenance system ● Longer service life ● Enclosed trough, protection against snow and ice ● Space-saving compared to conventional system ● Compact and safe ● Travel (S) = 42 m ● Assembled with igus® Chainflex® cables



System LBT Flizz®

Phone +49- (0) 22 03-96 49-800

Fax +49- (0) 22 03-96 49-222

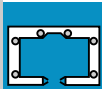
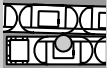

# Micro Flizz®

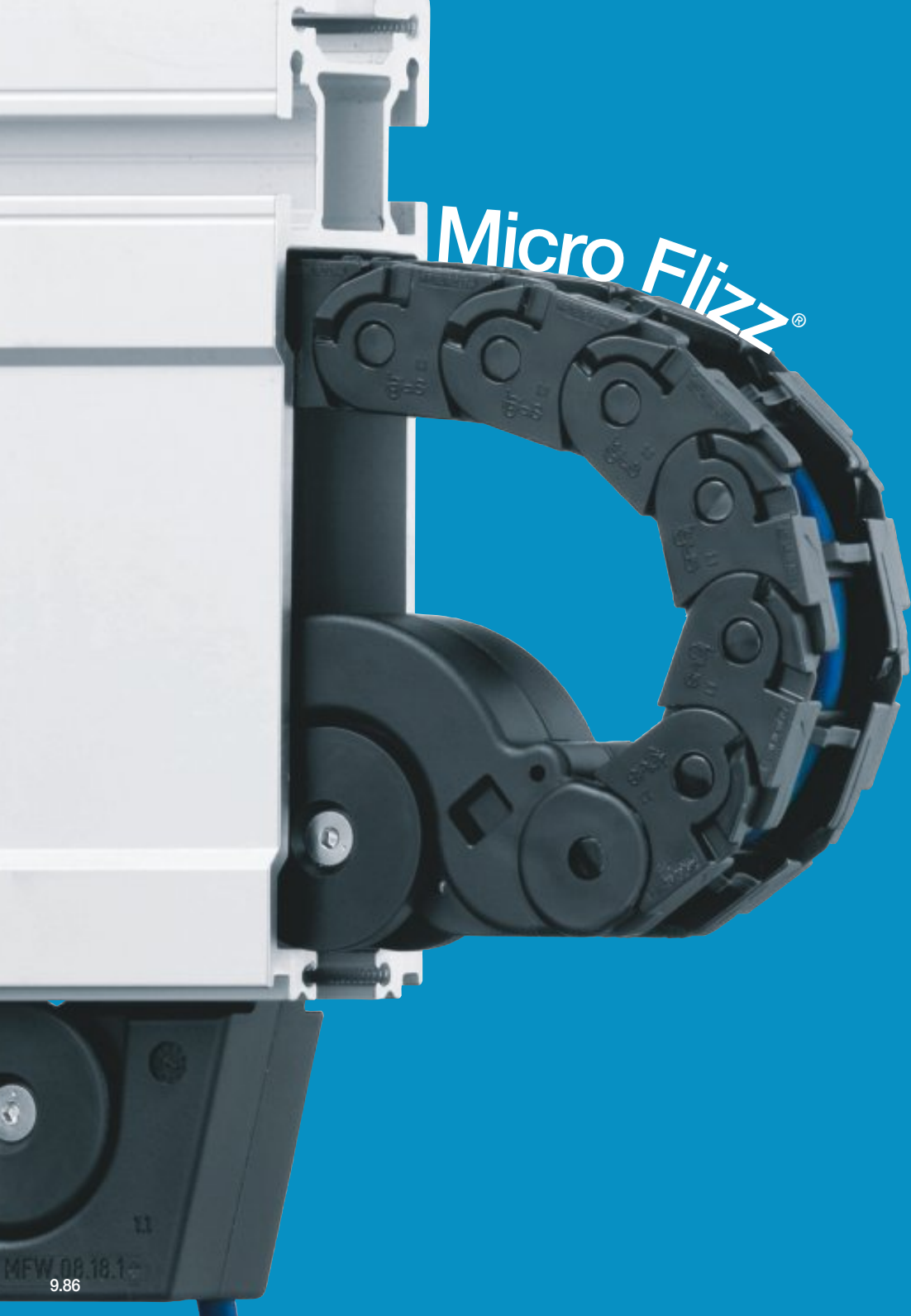





**Master long travels with the smallest E-Chain® without failures**

- ONE compact system for a secure guidance of power, data and air
- Maintenance-free alternative for busbar
- E-Chain® is guided in special slot, no sliding against each other
- Control via stationary switch cabinet possible
- Accelerations up to 50 m/s<sup>2</sup> and speeds up to 6 m/s
- Fast assembly due to pre-configured, modular system
- Less space required
- Available also as pre-assembled
- Smooth running due to ball bearings in the guide carriages
- Also with EX tested E-Chain® available (on request)
- Rail material: anodized aluminum
- iF-Design Award



**Cable diameter  
ø max 9,5 mm**

**Typical industries and applications**

- Rack feeder ● Indoor cranes ● Industrial gates ● Working stations ● Sewage treatment plants ● Camera systems ● Sliding doors ● Operator panels ● Measure systems ● Studio equipment ● Conveyor technique



**Special feature of the Micro Flizz® construction**

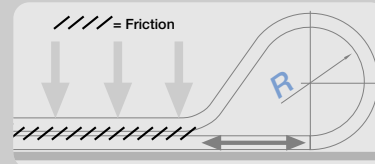

**Yesterday:** Moving lower run, sliding function. Long travels need stable E-Chains®.

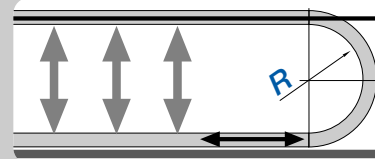

**Today:** Micro Flizz® - Small E-Chains®, self-guiding in guiding channel - Friction is reduced by factor 3 over the conventional system.

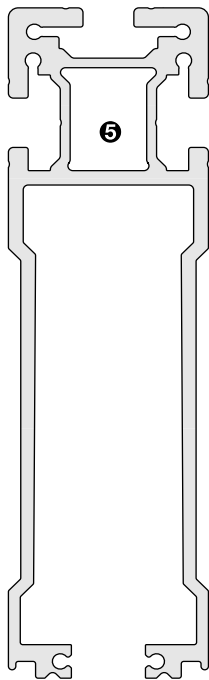

**Technical data Micro Flizz®**

- ❶ Separated upper and lower run of the Flizz® E-Chain®, thus less friction and reduced push/pull forces
- ❷ Winglets hold the E-Chain® secure in the guidance channel
- ❸ Polymer springs for a soft unrolling of the E-Chain® in the Flizz® channel effect a substantial noise reduction
- ❹ Integrated strain relief in the guide carriage for the safe fixing of cables
- ❺ Universal attachment options due to three T-grooves
- ❻ Attachment of the E-Chain® by roller cart on the moving end, gliding or locking possible
- ❼ Opposed E-Chains® can be used, that means a double filling or two independent travels are possible

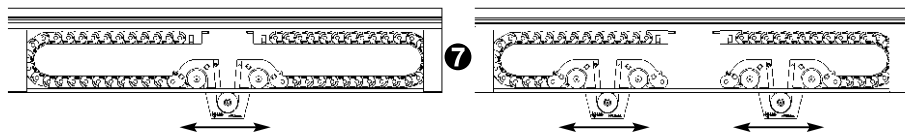
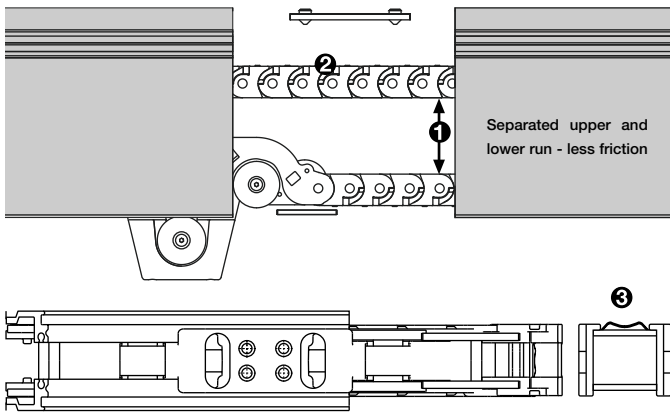

**Details Micro Flizz®**



Separated upper and lower run: Running trough the radius, integrated winglets fold in

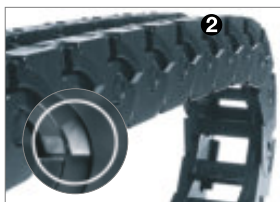

In the extended position, the winglets fold out and safely hold the upper run in the elevated position

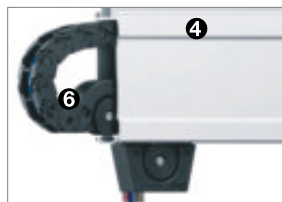

Power, data, pneumatics in confined areas. Chainflex® cables are specifically designed for this challenge

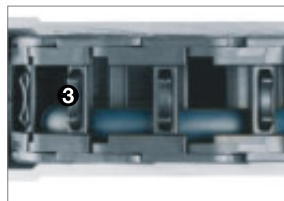

A polymer spring element cushions the motion inside the trough and lower noise



Micro Flizz® accessory:  
 Connection for compressed air coupling



Potential application area of the Micro Flizz® - Storage and retrieval units for high-bay warehouses, indoor cranes, etc.

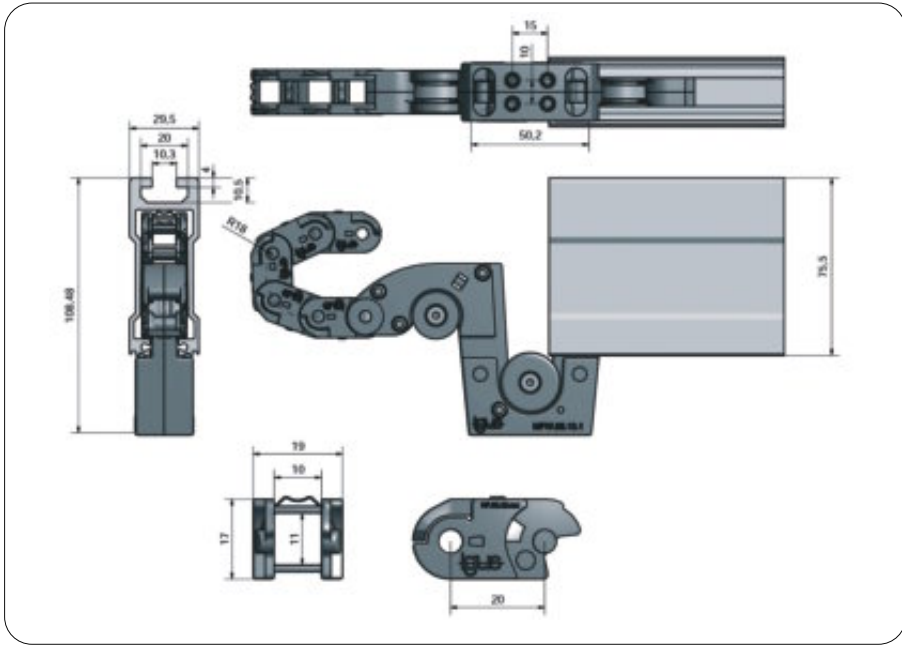

Micro Flizz® Series MF06 - Part No. MF.06.10.018

Micro Flizz® Series MF06

Part No.	Bi	Ba	hi	ha	R Bending radius
MF.06.10.018	10	19	11	17	018

igus® Micro Flizz®

Phone +49- (0) 22 03-96 49-800  
 Fax +49- (0) 22 03-96 49-222

Micro Flizz®



LeviChain

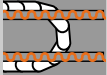

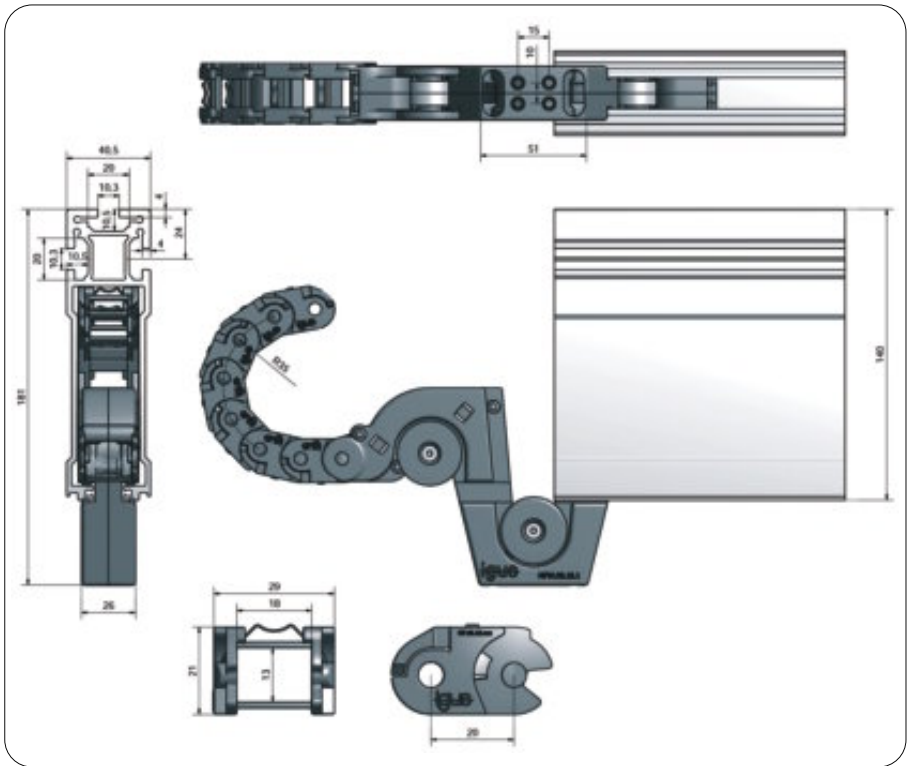

Micro Flizz® Series MF08 - Part No. MF.08.18.035

Micro Flizz® Series MF08

Part No.	<i>Bi</i>	<i>Ba</i>	<i>hi</i>	<i>ha</i>	<i>R</i> Bending radius
MF.08.18.035	18	29	13	21	035



Energy supply to the strip at cold storage house doors, in operation for more than one year.



- $s = 8,5 \text{ m}$  ●  $v = 4 \text{ m/s}$  ●  $a = 4 \text{ m/s}^2$  ● Filling: 1x CF9.15.04
- Running performance ca. 15.000 km without failure (issue 06.2006)



Micro Flizz® as "energy supplying rail guide" of a scale to weigh chemicals, etc.



Safe energy supply also under strong dust and dirt accumulation with igus® Micro Flizz®



- $s = 40 \text{ m}$  ●  $v = 4 \text{ m/s}$  ●  $a = 1 \text{ m/s}^2$  ●  $m_{\text{Chain}} = 0,21 \text{ kg/m}$
- $m_{\text{Cable}} = 0,09 \text{ kg/m}$  ● Filling: 1 x CF98.05.04

igus® Micro Flizz®

Phone +49- (0) 22 03-96 49-800  
Fax +49- (0) 22 03-96 49-222

Micro Flizz®



LeviChain

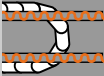



# LeviChain



### LeviChain - magnetic E-ChainSystem® - it "floats"

The principle of the magnetic "floatation" is based on the attractive forces of the prevailing magnetic field, which "centers" the E-Chain® in all directions. By this "centering" the E-Chain® moves almost contactless with favorable friction and wear behavior and minimum abrasion.

- Long travel possible without laying the E-ChainSystems® on top of each other
- Almost no abrasion and very low wear due to low-abrasion E-Chain® links (without pin/hole connection) as well as almost contactless movement of the E-Chain®
- Compared to other energy supply systems, the igus® System LeviChain is extraordinarily low noise [41.7 dB (A) in 1 m distance], as there is almost no rolling or sliding noise
- High speeds and accelerations are possible
- Simple assembly, even as a retrofit
- Variable installation positions (horizontal and vertical) possible
- Little space requirement in height and width
- IPA certificate



Long travels up to 40 m with high speeds and accelerations, almost contactless, with the new igus® LeviChain

### Typical industries and applications

- Cleanrooms
- Painting works/plants
- Medical technology
- Measuring technology
- Electronic manufacturing
- Automated storage and retrieval systems
- Material handling
- Industrial robots

### Applications-LeviChain

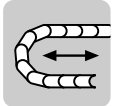

Unsupported applications

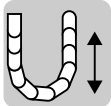

Vertical hanging applications

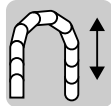

Vertical standing applications



Simple insertion of cables through the proven and tested "Easy" design

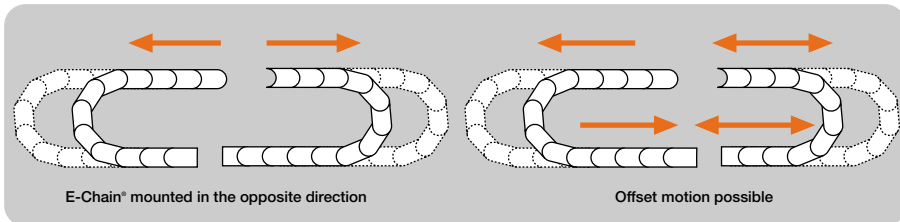



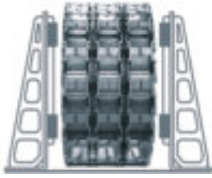

LeviChain also available  
as 2- and 3-strip E-Chain®



Three-strip E-Chain® assembled  
with igus® Chainflex® cables



Design LeviChain -  
Schematic diagram of  
the magnetic forces

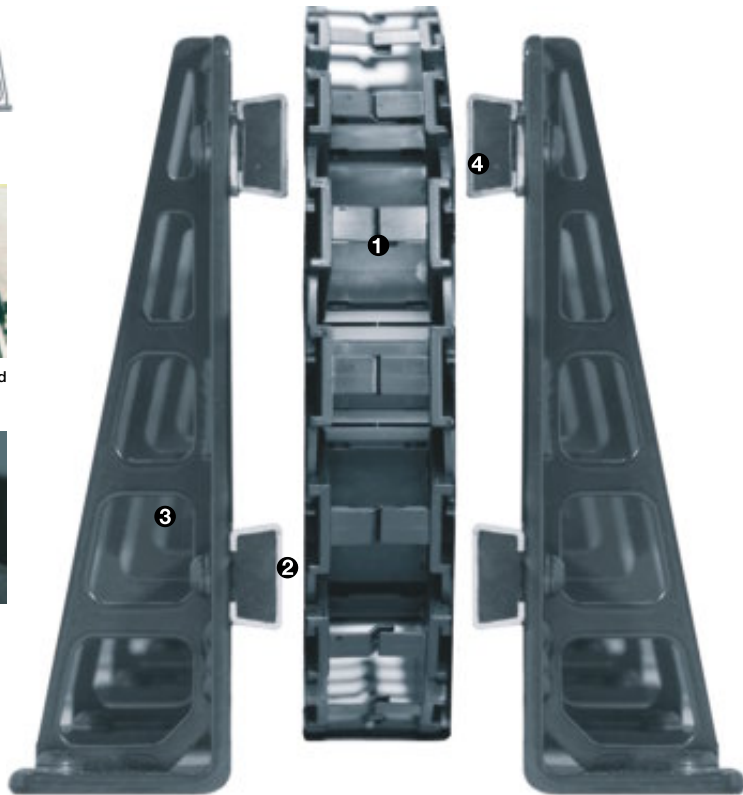

- ❶ Modular igus® E-Chain® different widths and bending radii
- ❷ Contactless guidance of upper run and (optional) lower run
- ❸ Support elements
- ❹ Magnet modules

**Values for 1-, 2-, 3-strip E-Chains®:**

- Max. additional load 4 kg/m
- Travel: 40 m



Unsupported application for very long travels. The upper and lower runs are not laid on top of each other on long travels. The lower run can also be guided "floating" without contact. Max. additional load up to 4 kg/m. Travels up to 40 m possible.

Technical Data

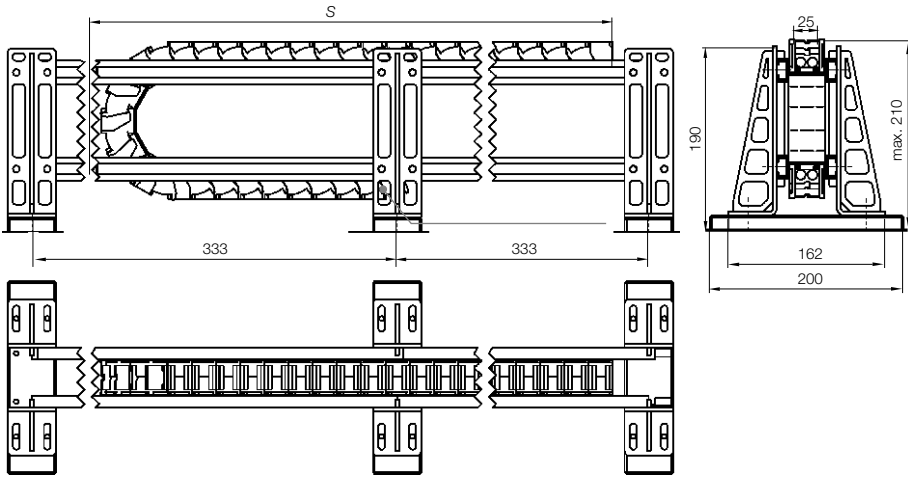

Product Range

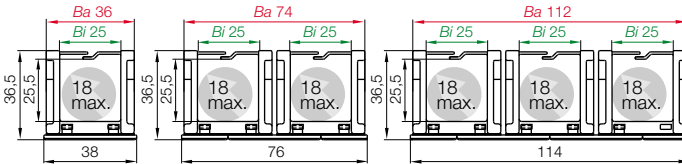

LeviChain - Dimensions

Part No.	Bi	Ba	hi	ha	R Bending radius
LV.25.25.....	25	36	25,5	36,5	045 063 075 100 125 150 175 200
LV.25.2/25.....	2 x 25	74	25,5	36,5	045 063 075 100 125 150 175 200
LV.25.3/25.....	3 x 25	112	25,5	36,5	045 063 075 100 125 150 175 200

Upon request - Delivery time: approx. 4-6 weeks after receipt of order!

LV 25. 3/25. 125. 1500. MM. RL



Part No. structure - LeviChain  
LV.25.3/25.125.1500.MM.RL

- Option RL: E-Chain® counter run (E-Chain® right and left)
- Magnetic module: M = Magnetic module / B = Delivery plate / MM = Magnetic module top/bottom / MB = Magnetic module top, delivery plate bottom
- Travel S: min. 1000 mm - in 25 mm steps
- Bending radius R
- 1-, 2-, 3-Band-E-Chain® and inner width Bi
- Inner height hi
- Series: igus® LeviChain-System

Band-E-Chain LV.25.3/25.125.1500.MM.RL -

LeviChain as 3-strip model and magnetic modules mounted top/bottom

igus® LeviChain

Phone +49- (0) 22 03-96 49-800  
Fax +49- (0) 22 03-96 49-222

Micro Flizz®



LeviChain



CFX 12.2

# Chainfix

## Strain Relief

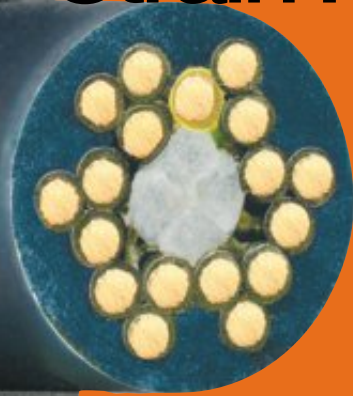

### Chainfix clamps and stainless-steel clamps - for maximum pull forces



Product	ø [mm]	Page
<b>Clamps and saddle clamp elements</b>	<b>from - to</b>	
Single clamp housing, including top/bottom saddle clamps	6 - 42	10.5
Double clamp housing, incl. top/bottom saddle clamps and 1 stacker saddle clamp	6 - 34	10.5
Triple clamp housing, incl. top/bottom saddle clamps and 2 stacker saddle clamp	6 - 22	10.5
Single stainless steel*-clamp housing, including top/bottom saddle clamps	6 - 42	10.5
Double stainless steel* clamps for 2 cables incl. mating trough and double trough	6 - 34	10.5

### Chainfix tiwrap plates - for universal tiwrap, bolted or clip-on

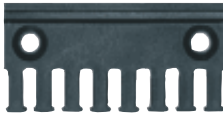

Product	Page
<b>Chainfix tiwrap plates</b>	
<b>Option 1:</b> Chainfix tiwrap plates as single parts Series 2000	10.8
<b>Option 1:</b> Chainfix tiwrap plates as single parts Series 3000	10.8
Cable tiwraps	10.8

### Chainfix tiwrap plates - for strain relief with cable tiwraps for C-profile

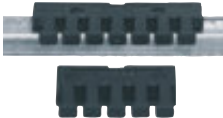

Product	Page
<b>Chainfix tiwrap plates</b>	
<b>Option 2:</b> Tiwrap plates with clip-on connection for the C-profile	10.9
<b>Option 3:</b> Clip-on tiwrap plates for opening or fixed crossbars	10.9
<b>Option 4:</b> Integrated strain relief for E2 Tubes - Series R	10.9

### Chainfix Clips - high pull forces, plug-in



Product	ø [mm]	Page
<b>Chainfix Clips</b>	<b>from - to</b>	
Available for all igus® E-ChainSystems® with C-profiles and also suitable for assembly in the KMA mounting brackets and Clip-on strain relief for crossbars	0 - 24	10.10

### Chainfix Nuggets - strain relief for small space and cables up to 20 mm o.d



Product	ø [mm]	Page
<b>Chainfix Nuggets</b>		
Very small strain relief for the fixation of cables up to diameter of 20 mm	≤ 20	10.10

### Chainfix strain relief separators - with integrated teeth



Product	Page
<b>Chainfix strain relief separators</b>	
Separator with integrated strain relief - easy strain relief with tie wrap	10.10

### Blocks - Special strain relief for hoses. A Modular, space-saving system



Product	Page
<b>blocks</b>	
Strain relief for hoses, modular, space-saving system	10.11

E-Chain® Series	Chainfix					Chainfix tiwrap plates						
	Clamp <sup>1)</sup>	Clip C-profile <sup>1)</sup>	Clip cross-bar <sup>1)</sup>	Nugget <sup>1)</sup>	Strain relief separator <sup>2)</sup>	Single part 2000 <sup>2)</sup>	Single part 3000 <sup>2)</sup>	Clip-on for C-profile <sup>2)</sup>	Fixed crossbar <sup>2)</sup>	Cross-bar <sup>2)</sup>	For Triflex <sup>2)</sup>	For E-Tube <sup>2)</sup>
Triflex®												
Easy Triflex®											E33X.XX.2	
Triflex®											33X.XX	
EasyChain®												
E/Z200						20XX.ZB			2050.Z			
E/Z26							30XX.ZB					
E/Z300							30XX.ZB					
E2/000												
1400/1500						20XX.ZB						
1450/1480						20XX.ZB						
2400/2500					2020.Z	20XX.ZB			2050.Z			
2450/2480					2020.ZR	20XX.ZB						
2600/2700	X	X		X	262.Z		30XX.ZB	30XX.ZC	2050.Z	2050.Z		
2650/2680	X	X		X			30XX.ZB	30XX.ZC		2050.Z*		
3400/3500	X	X		X	301.Z		30XX.ZB	30XX.ZC	30XX.Z	30XX.ZS		
3450/3480	X	X		X	34501.Z		30XX.ZB	30XX.ZC		30XX.ZS*		
255						20XX.ZB						
E2 E-Tubes												
R117/118						20XX.ZB						
R157/158					1585.01.Z							
R167/168					1685.01.Z							
R48					481.ZR	20XX.ZB						
R58											5850.Z	
R68											3050/3075.Z	
E4/00												
210					T2103.Z							
220/R760						20XX.Z				2050.Z		
280/290/R770	X	X		X			30XX.ZB	30XX.ZC		3850.ZS		
380/390/R780	X	X		X			30XX.ZB	30XX.ZC		3850.ZS		
400/410/R880	X	X	X	X			30XX.ZB	30XX.ZC		45XX.ZS		
600/601/R608				X			30XX.ZB					
640				X			30XX.ZB					
800				X			30XX.ZB					
840				X			30XX.ZB					
E4/4												
2828/2928/R7728	X	X		X			30XX.ZB	30XX.ZC		3850.ZS		
3838/3938/R7838	X	X		X			30XX.ZB	30XX.ZC		3850.ZS		
4040/4140/R8840	X	X	X	X			30XX.ZB	30XX.ZC		45XX.ZS		
5050/5150/R9850	X	X	X	X			30XX.ZB	30XX.ZC		45XX.ZS		
E4/light												
14040/14140/R18840	X	X	X	X			30XX.ZB	30XX.ZC		45XX.ZS		
14240/14340	X	X		X			30XX.ZB	30XX.ZC		3850.ZS		
15050/15150/R19850	X	X					30XX.ZB	30XX.ZC		45XX.ZS		
1640/R1608				X			30XX.ZB					
E6												
E6.29					E6.29.02Z	20XX.ZB						
R6.29						20XX.ZB						
E6.35					E6.35.02Z	20XX.ZB						
E6.40	X	X		X		20XX.ZB						
E6.52	X	X		X			30XX.ZB	30XX.ZC		3850.ZS		
R6.52	X	X		X			30XX.ZB	30XX.ZC				
E6.62	X	X		X			30XX.ZB	30XX.ZC		3850.ZS		
E6.80L	X	X	X	X			30XX.ZB	30XX.ZC		45XX.ZS		
E6.80	X	X	X	X			30XX.ZB	30XX.ZC		45XX.ZS		

■ = Recommended strain relief for selected E-Chain® \*only half E-Tube

<sup>1)</sup> you'll find on ► page 10.4 <sup>2)</sup> you'll find on the product page of each E-Chain® Series



Chainfix clamps for the following E-Chains®:

#### System E2/000

- 2600/2650/2680/2700
- 3400/3450/3480/3500

#### System E4/00

- 280/290/R770
- 380/390/R780
- 400/410/R880

#### System E4/4

- 2828/2928/R7728
- 3838/3938/R7838
- 4040/4140/R8840
- 5050/5150/R9850

#### System E4/light

- 14040/14140/R18840
- 14240/14340
- 15050/15150/R19850

#### System E6

- E6.40
- E6.52 / R6.52
- E6.62
- E6.80L / E6.80

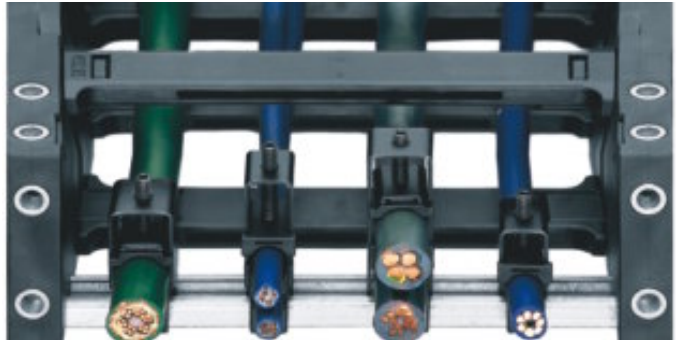

### Strain relief elements with Chainfix clamps and saddle clamp elements

The Chainfix clamp system design principle has proven itself as effective, life-prolonging strain relief for igus® E-ChainSystems®. Clamps are the best solution for all E-Chains® with a KMA-mounting brackets with C-profile option. **Product range:** ● Chainfix clamp housing with setscrew and top saddle clamp; bottom saddle clamp; stacker saddle clamp ● C-profile **Materials:** Clamp housing: Black lacquered steel, setscrew: Black steel, saddle clamps: igumid G

### Important improvements are offered by igus® exclusive Chainfix products:

- Optimal igus® Chainfix housing with reduced height
- Long service life for dynamic applications thanks to improved clamping elements
- Integration with KMA mounting brackets:
  - Saves both time and space during installation
  - Available for complete systems with cables and strain relief
- Improved clamping foot for easier fit in the C-profile Ideally, the cables/hoses should be strain relieved at both ends of the E-Chain®
- Improved housing foot clamp for easy fit into C-profile
- Newly developed housing with reduced overall height
- Black housing and setscrews for attractive appearance
- Setscrews, tightened with Allen wrench, for easy installation

### Overall height restrictions

If the E-Chain® glides on itself over long travel distances, the screw heads of the strain relief® on the fixed end must be at least 10 mm below the E-Chain® link height. Our newly developed clamp housing with setscrews reduces the overall height by up to 15 mm compared to conventional clamp housings. In the case of unsupported E-Chains®, the strain relief elements may be used with no problems. When using Chainfix clamps on C-Profile in the mounting bracket for Series 280, 2828,28, 290, 2928, 29, R770, R7728, R77 a shortened mating trough must be used. The Part No. for this is: CFX...K (add letter "K" to the above Part No.)



#### Note:

- Ideally, the cables/hoses should be strain relieved at both ends of the E-Chain®. At the very least, they must be strain relieved **at the moving end of the E-Chain®**.
- When using Chainfix clamps on C-Profile in the mounting bracket for Series 280, 2828,28, 290, 2928, 29, R770, R7728, R77 a **shortened mating trough must be used**. The Part No. for this is: CFX...K (add letter "K" to the above Part No.)



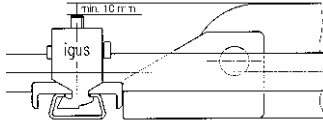
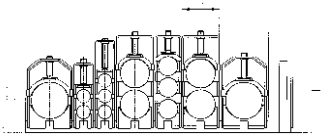

The dimensions given for H in the tables are based on the maximum cable diameter.  
Cables with smaller diameters may result in lower overall clamp housing heights.



Setscrew and reduced optimal housing height for use in long-sliding travel applications

**Single clamp housing, including top/bottom saddle clamps**



Steel	Stainless steel*				
Part No.	Part No.	ø [mm]	B	H	
CFX12.1	CFX12.1.E	06 – 12	16	58	
CFX14.1	CFX14.1.E	12 – 14	18	50	
CFX16.1	CFX16.1.E	14 – 16	20	52	
CFX18.1	CFX18.1.E	16 – 18	22	54	
CFX20.1	CFX20.1.E	18 – 20	24	56	
CFX22.1	CFX22.1.E	20 – 22	26	58	
CFX26.1	CFX26.1.E	22 – 26	30	67	
CFX30.1	CFX30.1.E	26 – 30	34	71	
CFX34.1	CFX34.1.E	30 – 34	38	75	
CFX38.1	CFX38.1.E	34 – 38	42	79	
CFX42.1	CFX42.1.E	38 – 42	46	83	

\*Material stainless steel: 1.4301



Improved housing foot clamp for easy fit into C-profile rail

**Double clamp housing, including top/bottom saddle clamps and one stacker saddle clamp**



Steel	Stainless steel*				
Part No.	Part No.	ø [mm]	B	H	
CFX12.2	CFX12.2.E	06 – 12	16	72	
CFX14.2	CFX14.2.E	12 – 14	18	74	
CFX16.2	CFX16.2.E	14 – 16	20	78	
CFX18.2	CFX18.2.E	16 – 18	22	82	
CFX20.2	CFX20.2.E	18 – 20	24	86	
CFX22.2	CFX22.2.E	20 – 22	26	90	
CFX26.2	CFX26.2.E	22 – 26	30	109	
CFX30.2	CFX30.2.E	26 – 30	34	117	
CFX34.2	CFX34.2.E	30 – 34	38	125	

\*Material stainless steel: 1.4301

**Triple clamp housing, including top/bottom saddle clamps and two stacker saddle clamps**



Steel	Stainless steel*				
Part No.	Part No.	ø [mm]	B	H	
CFX12.3	–	06 – 12	16	100	
CFX14.3	–	12 – 14	18	96	
CFX16.3	–	14 – 16	20	102	
CFX18.3	–	16 – 18	22	108	
CFX20.3	–	18 – 20	24	114	
CFX22.3	–	20 – 22	26	120	

\*Material stainless steel: 1.4301





Ribbed strain relief saddle clamps withstands increased pull forces for long-term durability

Bottom saddle clamps for single/double/triple clamp housings as single part

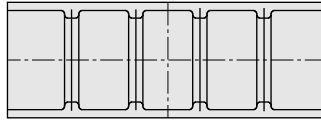
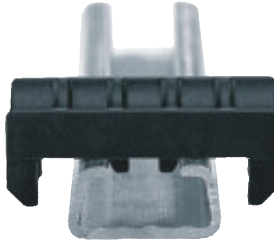

Part No.	ø [mm]
<b>Bottom saddle clamps</b>	
CG12	06 – 12
CG14	12 – 14
CG16	14 – 16
CG18	16 – 18
CG20	18 – 20
CG22	20 – 22
CG26	22 – 26
CG30	26 – 30
CG34	30 – 34
CG38	34 – 38
CG 42	38 – 42

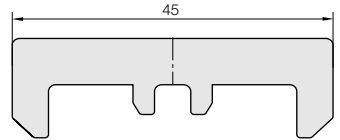

Stacker saddle clamps for double/triple clamp housings - for placement between stacked cables

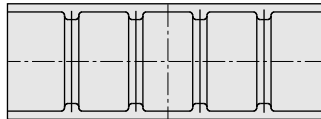

Part No.	ø [mm]
<b>Stacker saddle clamps</b>	
CD12	06 – 12
CD14	12 – 14
CD16	14 – 16
CD18	16 – 18
CD20	18 – 20
CD22	20 – 22
CD26	22 – 26
CD30	26 – 30
CD34	30 – 34

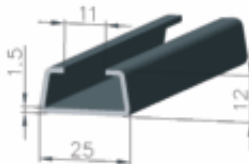
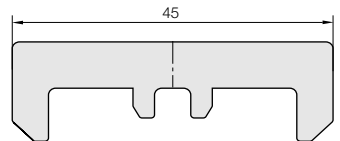

### Stainless steel C-profile

Stainless steel C-profile for all clamps, also for assembly in the KMA connection element Series 280, 2828, 28, 380, 3838, 38, 400, 4040, 40, 140, 142 und 5050, 50, 150, **Part No. CF92.42 .....** .E (specify length in mm)

**We have tested three different strain relief types**

- ❶ Standard, hot-dipped galvanized steel strain relief clamp with single and double impact-resistant polymer saddle clamp elements (Part No. CF14.1.Z, standard elements)
- ❷ Standard strain relief housings (as used in ❶) with igumid G clamp saddles (Part No. CFY14.1)
- ❸ igus® Chainfix strain relief elements (Part No. CFX14.1)

**Results:** Strain relief element ❶ saddle clamps loosen at 1.000 N of pull force. The resulting diagonal position of the saddle clamp distorts the screw. Strain relief element ❷ saddle clamps loosen at 1.750 N of pull force. The improved igumid G saddle clamps attempt to hold the cable, causing the outer jacket to "peel." Strain relief element ❸ (igus® Chainfix system) saddle clamps loosen and slant 5° at 1.750 N. At 2.500 N of pull force, the cable jacket bunches up behind the clamp and, at 3.500 N of pull force, the clamps loosen completely and the cable becomes inoperative.

**Conclusion:** The tensile strength of the "Chainfix" line of strain relief elements developed by igus® is more than three times higher than the tensile strength of standard strain relief elements.

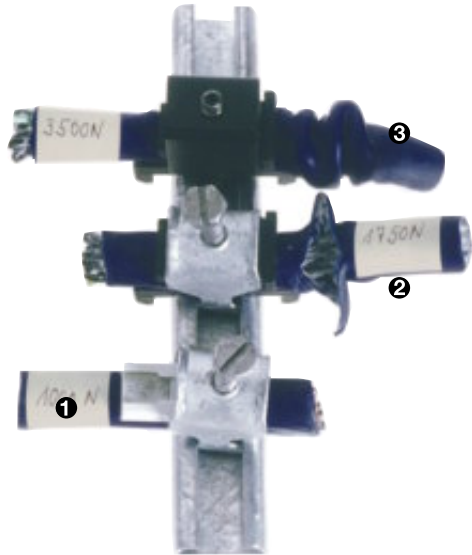
**Tensile strength test example with cable Ø 10,5 mm**

- Tiewrap plate 2070ZB with a cable tiewrap

**Result:** Tensile strength 290 N

- Chainfix clip CFC-12-M

**Result:** Tensile strength 350 N

**Pull force test for igus® tiewrap plates with cable tiewraps**

**Results:** Two tiewraps are more stable than one tiewrap. If one cable tiewrap is used, the breaking force is (approx.) 350 N. If the cable is secured with two cable tiewraps, the breaking force increases to 830 N, i.e. pull force resistance more than doubles when using two cable tiewraps.

**Technical data:**

- Tiewrap plates: 2100.ZB/3100.ZB
- Cable: CF1.07.12
- Cable tiewrap: CFB.001



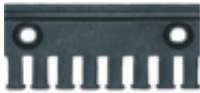

Tiewrap plate for the following E-Chains®:

#### Easy Chain®

- E200/Z200
- System E2/000
  - 1400/1500/1450/1480
  - 2400/2500/2450/2480
  - 255

#### System E2 E-Tubes

- R117/R118
- R48

#### System E4/00

- 220 (2050.Z)

#### System E6

- E6.29/R6.29
- E6.40



Tiewrap plate for the following E-Chains®:

#### Easy Chain®

- E26/Z26
- E300/Z300
- System E2/000
  - 2600/2700/2650/2680
  - 3400/3500/3450/3480

#### System E4/00

- 280/290/R770
- 380/390/R780
- 400/410/R880
- 600/601/R608
- 640
- 800
- 840

#### System E4/4

- 2828/2928/R7728
- 3838/3938/R7828
- 4040/4140/R8840
- 5050/5150/R9850

#### System E4/light

- 14040/14140/R18840
- 14240/14340
- 15050/15150/R19850
- 1640

#### System E6

- E6.52/R6.52
- E6.62
- E6.80L / E6.80

## Option 1: Chainfix tiewrap plates as single parts

Characteristic features: ● As individual component screwed on KMA (plastic metal mounting brackets)

● Can be plugged in the mounting brackets ● Use: single part for the manufacturing of switchgear cabinets or for the assembly of machines ● Accessory for igus® E-ChainSystems®

### Series 2000 - Tiewrap plate as single part

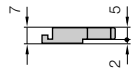
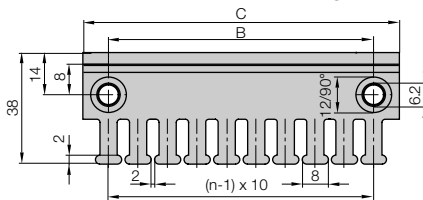

Single tiewrap plate

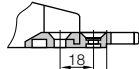

Shown assembled

Tiewrap plate	n Number of teeth	Dim. C [mm]	Dim. B [mm]	Center bore (- = no / + = yes)
2020.ZB	3	30	15	-
2030.ZB	4	40	20	-
2040.ZB	5	50	30	-
2050.ZB	6	60	40	-
2070.ZB	8	80	60	-
2090.ZB (= 2030.ZB + 2040.ZB)	9	90	-	-
2100.ZB	10	100	80	-
2125.ZB (= 2050.ZB + 2050.ZB)	12	120	-	-

### Series 3000 - Tiewrap plate as single part

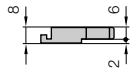
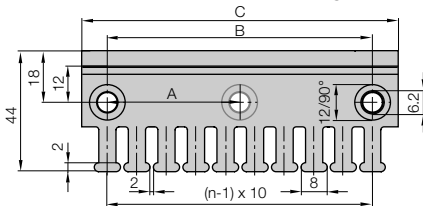

Single tiewrap plate

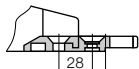

Shown assembled

Tiewrap plate	n Number of teeth	Dim. A [mm]	Dim. C [mm]	Dim. B [mm]	Center bore (- = no / + = yes)
3050.ZB	5	-	50	30	-
3075.ZB	7	-	75	55	-
3100.ZB	10	-	100	80	-
3115.ZB	11	-	115	95	-
3125.ZB	12	-	125	105	-
3150.ZB	15	-	150	130	-
3175.ZB	17	-	175	155	-
3200.ZB	20	90	200	180	+
3225.ZB	22	102,5	225	205	+
3250.ZB	25	115	250	230	+

### Cable tiewraps as single part

Cable tiewraps (100-piece bag)	Width x length [mm]	Maximum Ø [mm]	Pull force resistance
CFB.001	4,8 x 150	36	222N

**Option 2: Tiewrap plates with clip-on connection for the C-profile**

**Characteristic features:** ● Can be plugged into the KMA C-profile ● Easy solvable with screwdriver ● Easy to assemble without any screws. Easy solvable with screwdriver nevertheless safe stop ● **Use:** single part for the manufacturing of switchgear cabinets or for the assembly of machines ● Accessory for igus® E-ChainSystems® ● For all E-Chains® with KMA and integrated C-profile



For the following E-Chains®:

For all mounting brackets with C-Profil-option!



Part No.	Width [mm]	Number of teeth
3050.ZC	50	5
3075.ZC	75	7

Strain relief

**Option 3: Clip-on tiewrap plates for opening or fixed crossbars**

**Characteristic features:** ● Can be plugged on the fixed crossbars ● In case of many harnessed cables with strain relief "over two floors" ● If the KMA is too small for the C-profile ● Easy to assemble without any screws ● **Use:** single part for the manufacturing of switchgear cabinets or for the assembly of machines ● Accessory for igus® E-ChainSystems®



For the following E-Chains®:

For more details see table!



Part No.	Width [mm]	Number of teeth	For Series
2050.Z	60	6	E/Z200, 2400/2500, 2600/2700
3050.Z	50	5	3400/3500
3075.Z	74	7	3400/3500

Part No.	Width [mm]	Number of teeth	For Series
2050.Z	60	6	220, 2650
3035.ZS	35	3	3400/3450/3500
3050.ZS	50	5	3400/3450/3500
3075.ZS	75	7	3400/3450/3500
3850.ZS	48	5	280/290/R770, 380/390/R780, 2828/2928/R7728, 3838/3938/R7838, 14240/14340, E6.52, E6.62
4550.ZS	48	5	400/410/R880, 4040/4140/R8840, 5050/5150/R9850, 14040/14140/R18840, 15050/15150/R19850, E6.80L, E6.80
4575.ZS	74	7	400/410/R880, 4040/4140/R8840, 5050/5150/R9850, 14040/14140/R18840, 15050/15150/R19850, E6.80L, E6.80

Phone +49- (0) 22 03-96 49-800  
Fax +49- (0) 22 03-96 49-222



**Option 4: integrated strain relief for E2 Tubes - Series R**

**Characteristic features:** ● Strain relief disappears completely in the E-Tube ● Easy to assemble without any screws ● **Use:** single part for the manufacturing of switchgear cabinets or for the assembly of machines ● Accessory for igus® E-ChainSystems®



For the following E-Tubes:

System E2 E-Rohre ● R58 ● R68



Part No.	Width of strain relief [mm]	Number of teeth	Series
3050.Z	50	5	R68
3075.Z	75	7	R68
5850.Z	47	4	R58



For the following  
E-Chains\*:

#### Chainfix Clip for C-profile:

For all KMA mounting brackets  
with C-profile-option!



Clip for C-profile  
Part No. CFC-XX-C

#### Clips for crossbars E4/00

- 400/410
- 640
- 840

#### Clips for crossbars E4/4

- 4040/4140
- 5050/5150

#### Clips for crossbars E4/light

- 14040/14140
- 14240/14340
- 14240/14340
- 15050/15150
- 1640

#### Clips for crossbars E6

- E6.80L
- E6.80



Clip for crossbars  
Part No. CFC-XX-B

## Chainfix clip - Modular snap-on for the C-profile

Available for all igus® E-ChainSystems with C-profiles. **Characteristic features:** ● Series of clamps and bottom parts made of plastic for cable diameters ranging from 4 mm to 24 mm ● Quick assembly without any tools ● 2 and 3 layers on top of one another possible ● Each layer can be detached and changed later on ● High tensile forces in case of single-layer installation, decreasing with the number of layers

ø Conduit [mm]	Part No. clamps	Part No. bottom part	A [mm]	B [mm]	C [mm]
04 - 08 mm	CFC-08-M	CFC-08-C	13,0	14,5	30
08 - 12 mm	CFC-12-M	CFC-12-C	24,0	23,7	36
12 - 16 mm	CFC-16-M	CFC-16-C	32,1	32,4	42
16 - 20 mm	CFC-20-M	CFC-20-C	39,1	43,2	45
20 - 24 mm	CFC-24-M	CFC-24-C	50,0	54,0	50

## Modular snap-on for crossbars

Available for all igus® E-ChainSystems with crossbar serie Part. No. 450.XX. **Characteristic features:** Series of clamps and bottom parts made of plastic for cable diameters ranging from 8 mm to 12 mm ● Quick assembly without any tools ● 2 and 3 layers on top of one another possible ● Each layer can be detached and changed later on ● High tensile forces in case of single-layer installation, decreasing with the number of layers

ø Conduit [mm]	Part No. clamps	Part No. crossbars	A [mm]	B [mm]	C [mm]
08 - 12 mm	CFC-12-M	CFC-12-B	24,0	23,7	36

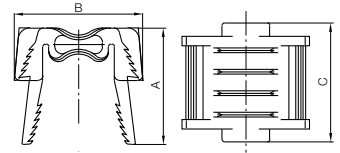
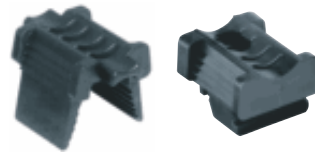

Phone +49- (0) 22 03-96 49-800  
Fax +49- (0) 22 03-96 49-222

igus® GmbH  
51147 Cologne



For the following  
E-Chains\*:

For more details  
see table!

## Chainfix nugget

**Characteristic features:** ● Very small strain relief for the fixation of cables up to diameter of 20 mm ● **Use:** accessory for all KMA with integrated C-profile ● Easy to assemble, without any screws and tools ● Adjustable to every E-Chain® filling ● Very small space requirement ● Easy strain relief due to fixation with pre-harnessed cable strap



Part No.	ø Conduit max. [mm]	Width [mm]
CFN.20	20	10,8



Internet: [www.igus.de](http://www.igus.de)  
E-mail: [info@igus.de](mailto:info@igus.de)

### Strain relief separator - Separator with integrated strain relief

**Characteristic features:** ● For the use in the first or last chain link ● **Use:** single part for the manufacturing of switchgear cabinets or for the assembly of machines ● **Accessory** for igus® E-ChainSystems® ● Easy to assemble without any screws ● The number *n* is depending on the selection of cable (diameter, type) and available space

For Series	Part No. Strain relief separator	Number of teeth	Dim. A [mm]	Dim. B [mm]	Dim. C min. distance le/r [mm]	Dim. D max. cable Ø [mm]
2400/2500	▶ 2020.Z	2	10	4	–	6
2450/2480	▶ 2020.ZR	2	10	4	–	6
2600/2700	▶ 262.Z	3	10	4	–	6
3400/3500	▶ 301.Z	3	18	4	–	14
3450/3800	▶ 34501.Z	3	14	4	–	10
R157/R158	▶ 1585.01.Z	3	22	4	–	18
R167/R168	▶ 1685.01.Z	4	22	4	–	18
R48	▶ 481.ZR	2	10	3,5	10	6,5
T210	▶ T2103.Z	2	8	4	13	4
E6.29/T3.29	▶ E6.29.02.Z	2	8	4	12	4
E6.35	▶ E6.35.02.Z	3	8	4	12	4

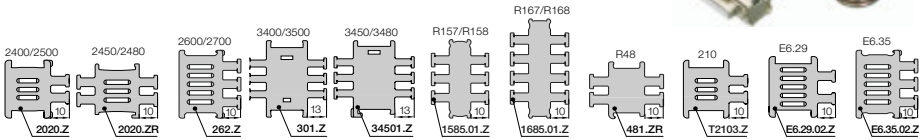
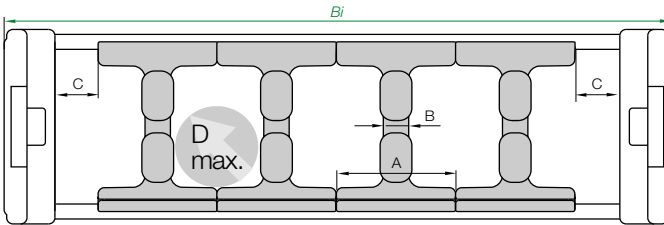

For the following E-Chains®:

- System E2/000**
  - 2400/2500/2450/2480
  - 2600/2700
  - 3400/3500/3450/3480
- System E2 E-Tubes**
  - R157/R158
  - R167/R168
  - R48
- System E4/00**
  - 210
- System E6 / T3**
  - E6.29 / T3.29
  - E6.35



Strain relief

Phone +49- (0) 22 03-96 49-800  
Fax +49- (0) 22 03-96 49-222



### igus® strain relief block for small hoses and cables

● Modular system for great adaptability ● No hose damage ● Easy installation - pressing the hose into the locating notch provides reliable fastening without hardware ● Hoses and cables can be installed together in the same E-Chain® ● Accommodation of hose diameters from 4.3 to 14 mm  
The modules accommodate hoses from 4.3 to 14 mm, 3 x 4.3 mm hoses can be fitted on top of each in module CFS 4.3 and 2 hoses can be fitted directly on top of each other in one notch using module CFS 6. The modules have a width of 27.5 mm, are inserted into the base plate and then fastened in position with M4 countersunk-head screws. The exception is module CFS 55.9 which offers the capacity for 5 x 9 mm hoses with twice the width. The base plate and cover plate are available in widths ranging from 75 to 240 mm. The height of the spacers and modules is 16 mm. Several layers can be installed directly above one another.

Part No. Blocks	Hose Ø [mm]	Number of hoses	Width [mm]
CFS 4,3	4,3	4 - 12	27,5
CFS 6	6,0	3 - 6	27,5
CFS 9	9,0	2	27,5
CFS 55,9	9,0	5	55,0
CFS 10	10,0	2	27,5
CFS 14	14,0	1	27,5

Part No. Base plate	Part No. Cover plate	Width [mm]
CFSU	CFSP	75,0
CFSU	CFSP	102,5
CFSU	CFSP	130,0
CFSU	CFSP	185,0
CFSU	CFSP	212,0
CFSU	CFSP	240,0

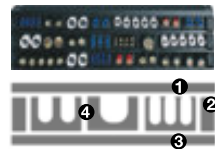

- 1 Cover plate
  - 2 Spacers
  - 3 Base plate
  - 4 Grid-dimensioned modules
- W = 27.5 mm, H = 16 mm

Part No. Spacer	Height [mm]
CFSD	16,0
CFSD	12,0



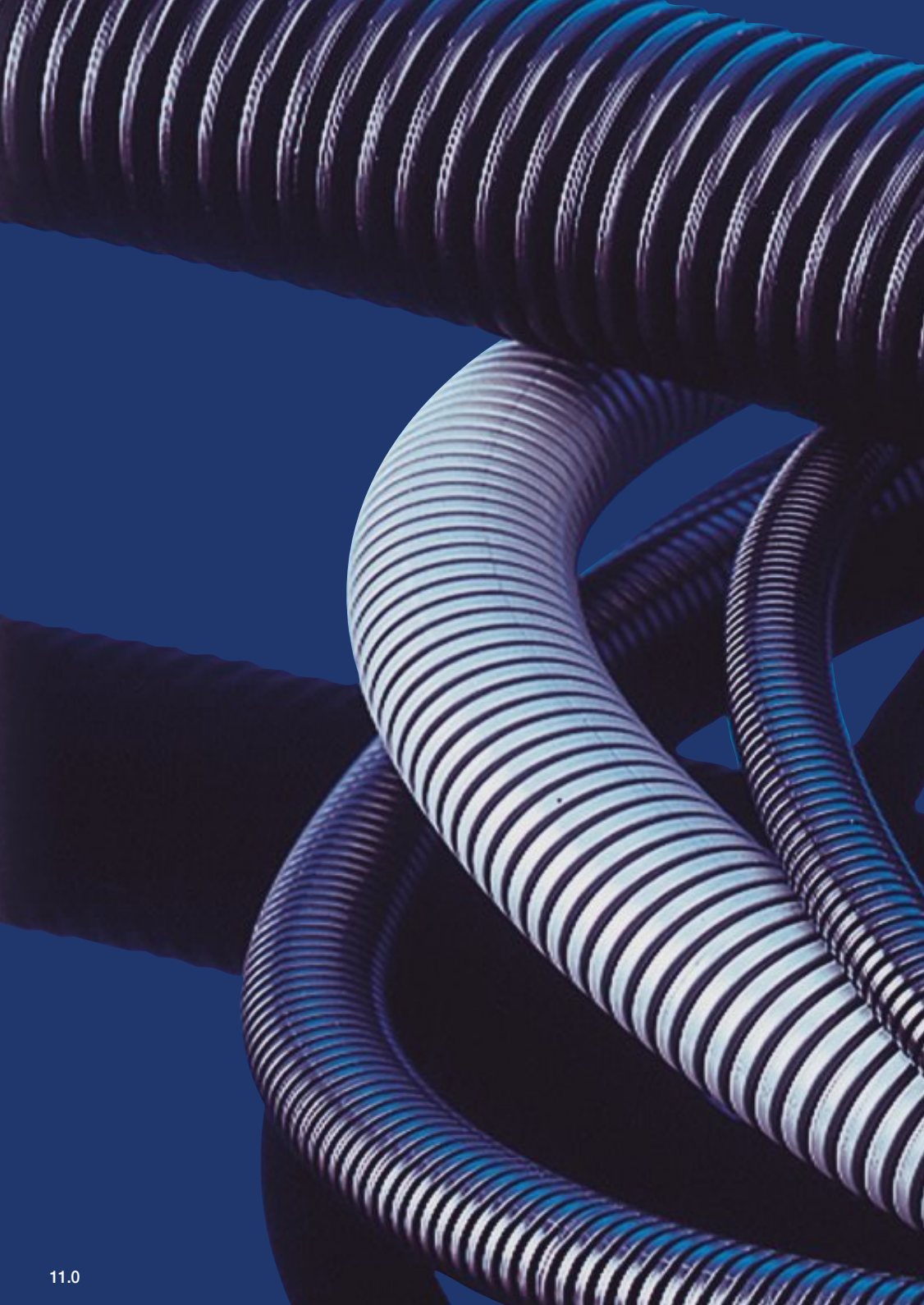



**PMA**

**PMAFLEX** | Conduits | Cable protection



Product	Description	Page
<b>PMA conduits</b>		
PACO	Flexible, medium, divisible	11.4
TN	Divisible connectors, PG	11.4
GTN	Divisible lock nuts, PG	11.4
PCL	Very flexible, medium	11.5
VOH	Pliable, very heavy	11.5
PIS/PIH	Highly flexible, medium	11.6
CYL	Very flexible, medium	11.7

**PMAFIX** | Connectors | Safety and sealing systems



Product	Description	Page
<b>PMA connectors</b>		
IP66 - stat., IP54 dyn.	Universal safety clip	11.8
IP68 - stat., IP67 dyn.	Oval clip	11.8
PMAFIX / PMAFLEX	Connectors	11.9
PMAFIX connectors VW	90° elbow, metric & PG	11.10
PMAFIX connectors VN	Straight, metric & PG	11.11
PMAFIX connectors VA	45° elbow, metric & PG	11.12
PMAFIX connectors VB	90° curved elbow, metric & PG	11.13
PMAFIX connectors VO	Flange 90°	11.13

**PMA** | Accessories



Product	Description	Page
<b>PMA accessories</b>		
PMAFIX FH0	One-piece system support	11.14
PMA MN	Hexagonal Lock Nuts, metric & PG	11.14
PMA SGB	Tube clamps	11.15
PMA 514	Plug Screws, metric & PG	11.15



## PMA - corrugated conduits, connectors, system support, accessories

- Wide range of tubes
- Long service life of the tubes especially through millions of reverse bending cycles (I-PIST)
- UL-approved products
- PMAFIX safety locking system

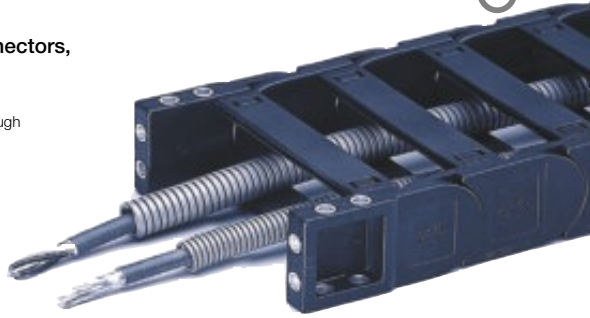

## PMA-Program - Wide selection of tubes and systems

The PMA cable protection system is applied wherever the mechanical protection of electrical wires and cables is required. Very flexible types of conduits are especially suitable for the additional protection of leads in E-ChainSystems® if required. By combining technical excellence with rigorous international safety standards, PMA meets the demands of industry worldwide - specialising in applications from the machine building industries to high tech manufacturing; heavy plant and vehicle construction; fiber optics, solar energy and robotic applications with high speed and millions of reversed bending cycles.

## PMAFLEX - Conduits

PMAFLEX covers different conduit types for a variety of applications in cable protection. The PMAFLEX range offers conduits for technically demanding applications and special requirements. Conduit sizes range from 4.5 mm to 125 mm diameters, from lightweight to heavyweight, and pliable to highly flexible. Standard colours are black and grey. Many conduits are specially approved, e.g. CSA, UL Recognition, NF, SNCF, DB, etc.

## PMAFI - Connectors

The designation PMAFIX describes a very large range of connectors for PMA conduits with the patented PMA safety clip system. Connectors are available for ingress protection IP66 and IP68. IP66 connectors are fitted with a preinstalled universal safety clip which ensures a quick "push-in" installation. IP68 connectors for increased requirements will be delivered with a special conduit seal cap.

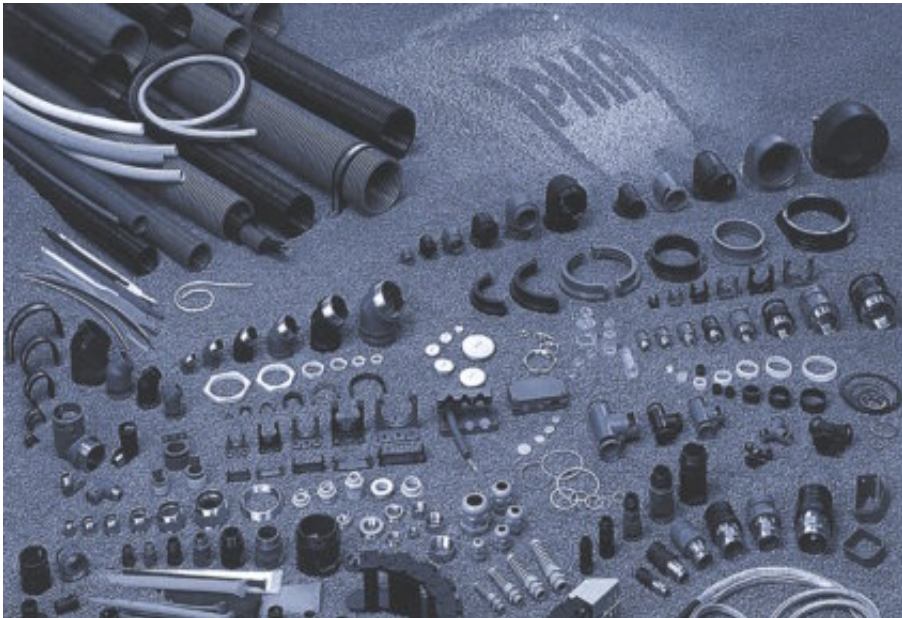

**PMAFLEX Conduits PACO - flexible, medium, divisible**

The PMA COFLEX conduit type PACO has been created for **retrofit and pre-loomed applications**. New cables can be added without the need for re-wiring or re-threading within the **building of machines and installations**. Further, this product will be used increasingly in **vehicle manufacturing and building construction**. Divisible connectors and locknuts are available for this product group. **Features:** ● Specially modified polyamide 6, good closure up to IP50 ● Self-extinguishing, free of halogen and cadmium ● Temperature range: -40 °C to 100 °C; **Short-term** to 130 °C ● **Chemical resistance:** To fuels, mineral oils, fats, alkalies, weak acids and bases etc.

Part No. structure

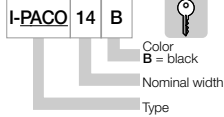

! I-PACO - is suitable  
■ for static use only!

Part No.	Conduit size NW	Inside Ø d1 [mm]	Outside Ø d2 [mm]	stat.** R [mm]	PU [m]
<b>black</b>					
I-PACO-10B	10	8.9	13.6	55	50
I-PACO-14B	14	12.9	18.7	75	50
I-PACO-20B	20	19.8	25.9	105	50
I-PACO-23B	23	23.7	31.3	125	50
I-PACO-37B	37	31.7	41.9	170	25
I-PACO-45B	45	43.1	54.2	180	25
I-PACO-70B	70	66.0	79.8	300	10

**TN - Divisible connectors, PG**

These divisible connectors are suitable for repairs or where cable protection systems are installed **after wiring** has taken place in the **machine building and installation industry**. Further, these products will be used increasingly in the **vehicle building and building construction**. **Features:** ● Specially formulated polyamide ● IP50, self-extinguishing, free of halogen, phosphor and cadmium ● Very good impact strength ● Temperature range: -30 °C to 100 °C; **Short-term** 130 °C

Part No.	Thread	Fits to conduit COFLEX NW	Inside Ø d1 [mm]	Wrench-Size	Dimensions length [mm]
<b>black</b>	<b>PG</b>				
I-BTNO-P0910	9	10	9.0	19.0	28.0
I-BTNO-P1314	13.5	14	13.0	24.0	35.0
I-BTNO-P2120	21	20	20.0	32.0	34.0
I-BTNO-P2923	29	23	31.0	41.0	42.0
I-BTNO-P2937	29	37	31.0	50.0	50.0

**GTN - Divisible lock nuts, PG**

These divisible lock nuts are used in connection with the connectors **TN** for repairs or where cable protection systems are **installed after wiring** has taken place in the machine building and **installation industry**. Further, these products will be used increasingly in the **vehicle building and building construction**. **Features:** ● Specially formulated polyamide ● Self-extinguishing, free of halogen, phosphor and cadmium ● Very good impact strength ● Temperature range: -30 °C to 100 °C; **Short-term** 130 °C

Part No.	Thread	Fits to COFLEX Connector	Wrench-Size	Dimensions height [mm]
<b>black</b>	<b>PG</b>			
I-BGTN-0910	9	I-BTNO-P0910	22.0	11.0
I-BGTN-1314	13.5	I-BTNO-P1314	30.0	14.0
I-BGTN-2120	21	I-BTNO-P2120	36.0	14.0
I-BGTN-2923	29	I-BTNO-P2923	46.0	17.0
I-BGTN-2937	29	I-BTNO-P2937	55.0	17.0



**PMAFLEX Conduits PC - very flexible, medium**

The PMAFLEX conduit type PCL is suitable for a wide range of applications in general machine building. Further more, this conduit type can be used in the vehicle building industry. The product is characterised by good weather resistance and applicability at low temperatures. **Features:** ● Specially modified polyamide 6/6.6 for cold impact ● Self-extinguishing ● Free of halogen and cadmium ● High impact strength also at low temperatures ● **Temperature range:** -50 °C to 105 °C; **Short-term** to 150 °C ● **Chemical resistance:** To fuels, mineral oils, fats, alkalies, weak acids and bases etc.

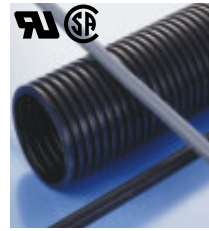

Part No. black	Part No. grey	Conduit size NW	Conduit size metric	Inside Ø d1 [mm]	Outside Ø d2 [mm]	stat.** R [mm]	PU [m]
I-PCLT-07B	I-PCLT-07S	7	10	6.2	10.0	15	50
I-PCLT-10B	I-PCLT-10S	10	12	9.6	13.0	20	50
I-PCLT-12B	I-PCLT-12S	12	16	12.0	15.8	30	50
I-PCLT-17B	I-PCLT-17S	17	20	16.2	21.2	40	50
I-PCLT-23B	I-PCLT-23S	23	25	22.6	28.5	45	50
I-PCLT-29B	I-PCLT-29S	29	32	29.0	34.5	55	50
I-PCLT-36B	I-PCLT-36S	36	40	36.5	42.5	60	30
I-PCLT-48B	I-PCLT-48S	48	50	47.5	54.5	70	30
I-PCLG-17B	I-PCLG-17S	17	20	15.3	21.2	40	50
I-PCLG-23B	I-PCLG-23S	23	25	21.9	28.5	45	50
I-PCLG-29B	I-PCLG-29S	29	32	27.6	34.5	55	50
I-PCLG-36B	I-PCLG-36S	36	40	36.0	42.5	60	30
I-PCLG-48B	I-PCLG-48S	48	50	47.0	54.5	70	30
I-PCLG-56B	I-PCLG-56S	56	68	56.3	67.2	130	30
I-PCLG-70B	I-PCLG-70S	70	80	67.5	80.0	160	30
I-PCLG-95B	I-PCLG-95S	95	106	91.5	106.0	210	30
I-PCLG-125B	I-PCLG-125S	125	146	126.5	146.5	450	6

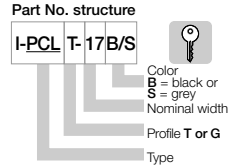

**I-PCLT/PCLG - is recommended for static use!**  
(moderate dynamic application possible)

PMA-Program

Phone +49- (0) 22 03-96 49-800  
Fax +49- (0) 22 03-96 49-222

**PMAFLEX Conduits VOH - pliable, very heavy**

The robust construction of PMAFLEX VOH conduit lends it outstanding impact and pull-out resistance. In the US market, this conduit type can also be used for exterior applications in machinery and installations (from 17 mm inside diameter). This product offers the greatest possible mechanical protection with good flammability properties. **Features:** ● Specially modified polyamide 6 ● Very good self-extinguishing properties ● Free of halogen and cadmium ● High impact strength and pull-out resistance ● High stiffness and compression strength ● Temperature range: -40 °C to 105 °C; **Short-term** to 150 °C ● **Chemical resistance:** To fuels, mineral oils, fats, alkalies, weak acids and bases etc.



Part No. black	Part No. grey	Conduit size NW	Conduit size metric	Inside Ø d1 [mm]	Outside Ø d2 [mm]	stat.** R [mm]	PU [m]
I-VOHD-07B	I-VOHD-07S	7	10	5.8	10.0	20	100
I-VOHD-10B	I-VOHD-10S	10	12	9.0	13.0	25	50
I-VOHD-12B	I-VOHD-12S	12	16	11.6	15.8	30	50
I-VOHG-17B	I-VOHG-17S	17	20	14.5	21.0	40	50
I-VOHG-23B	I-VOHG-23S	23	25	21.1	28.5	50	50
I-VOHG-29B	I-VOHG-29S	29	32	26.6	34.5	60	50
I-VOHG-36B	I-VOHG-36S	36	40	35.0	42.5	70	30
I-VOHG-48B	I-VOHG-48S	48	50	46.5	54.5	80	30
I-VOHG-56B	I-VOHG-56S	56	68	55.5	67.2	135	10
I-VOHG-70B	I-VOHG-70S	70	80	67.0	80.0	200	10
I-VOHG-95B	I-VOHG-95S	95	106	90.5	106.0	300	10
I-VOHG-125B	I-VOHG-125S	125	146	126.0	146.5	480	6

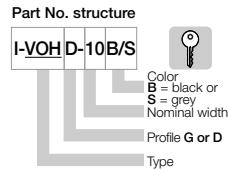

**I-VOHD/VOHG - is suitable for static use only!**

igus® GmbH  
51147 Cologne

Internet: [www.igus.de](http://www.igus.de)  
E-mail: [info@igus.de](mailto:info@igus.de)



**PMAFLEX Conduits PIS/PIH - highly flexible, medium**

These highly flexible products are used primarily in automation applications and for connections subject to intense movements in general machinery construction. Their outstanding material properties make these conduits especially suitable for outdoor applications where they are exposed to intense sunlight (UV).

**Features:** ● Specially modified polyamide 12 ● **PIS:** medium-wall (nominal width 07 to 48) - **PIH:** heavy-wall (nominal width 56 to 125) ● Self-extinguishing ● Free of halogen and cadmium ● Good mechanical properties also at low temperatures ● **Temperature range:** -50 °C to 95 °C; **Short-term to 150 °C** ● **Chemical resistance:** To fuels, mineral oils, fats, alkalies, acids and bases etc.

Part No. structure

I-PIS	T-48	B/S
-------	------	-----



Color  
**B** = black or  
**S** = grey  
 Nominal width  
 Profile **T** or **G**  
 Type

**I-PIS/PIH is recommended for highly flexible application**

Part No.	Part No.	Conduit	Conduit	Inside	Outside	stat.**/dyn.***	PU
black	grey	size NW	size metric	Ø d1 [mm]	Ø d2 [mm]	R [mm]	[m]
I-PIST-07B	I-PIST-07S	7	10	6.2	10.0	15 / 40	50
I-PIST-10B	I-PIST-10S	10	12	9.6	13.0	20 / 50	50
I-PIST-12B	I-PIST-12S	12	16	11.9	15.8	25 / 65	50
I-PIST-17B	I-PIST-17S	17	20	16.4	21.1	30 / 65	50
I-PIST-23B	I-PIST-23S	23	25	22.6	28.4	35 / 90	50
I-PIST-29B	I-PIST-29S	29	32	29.0	34.3	45 / 110	50
I-PIST-36B	I-PIST-36S	36	40	36.5	42.5	60 / 165	30
I-PIST-48B	I-PIST-48S	48	50	47.5	54.5	70 / 180	30
I-PISG-17B	-	17	20	15.2	21.1	30 / 80	50
I-PISG-23B	I-PISG-23S	23	25	21.7	28.4	40 / 100	50
I-PISG-29B	I-PISG-29S	29	32	27.4	34.3	50 / 120	50
I-PISG-36B	I-PISG-36S	36	40	35.8	42.3	60 / 180	30
I-PISG-48B	I-PISG-48S	48	50	46.7	54.2	70 / 200	30
I-PIHG-56B	I-PIHG-56S	56	68	56.3	67.2	110 / 270	30
I-PIHG-70B	I-PIHG-70S	70	80	67.2	79.6	150 / 350	30
I-PIHG-95B	I-PIHG-95S	95	106	91.3	106.0	170 / 450	30
I-PIHG-125B	I-PIHG-125S	125	146	126.5	146.5	350 / 580	20



**Fine profile T -**  
tight bending radius

**Coarse profile G -**  
high pull-out strength

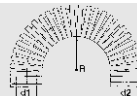

\*\* **stat. R** = lowest recommended bending radius for static (fixed) installation

\*\*\* **dyn. R** = lowest recommended bending radius for dynamic (flexible) installation





**IP66 - static, IP54 dynamic - universal safety clip**

- One piece Fitting, sealing by cone
- Easy "push-in" installation
- Pre-installed safety clip AFN2
- Fits any type of conduit profile (T and G)
- Excellent pull-out strength
- Re-opening for safety reasons only possible with a screwdriver
- Clip pre-installed in all IP66 connectors

**Installation**

1 Push in conduit with a slight twist (open using screwdriver on conduit side)



2 Pull back slightly to ensure the locking mechanism is fully engaged



3 To re-open use a screw-driver

**IP68 - static, IP67 dynamic - oval clip**

- High sealing through additional seal cap
- For highest dynamic applications
- Fits any type of conduit profile (T and G)
- Excellent pull-out strength
- Re-opening for safety reasons only possible with a screwdriver

**Installation**

1 **A** Conduit,  
**B** Seal cap,  
**C** Connector, **D**  
 Oval clip, **E** flat gas-  
 ket (or O-ring seal)



2 Push seal cap onto end of conduit to achieve IP68

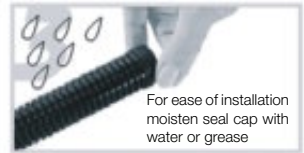

3 For ease of installation moisten seal cap with water or grease



4 Push conduit with seal cap fully into connector. This guarantees PMA's unique IP68/67 rating\*



5 Install retaining oval clip



6 To re-open use a screwdriver

\* For safety reasons, oval clip will not fit if seal cap is not fully installed.  
 Ensure to follow O-ring manufacturers guidelines when using O-rings for sealing purposes.



**PMAFIX - Connectors**

The designation **PMAFIX** describes a very large range of connectors for PMA conduits with the patented PMA safety clip system. Connectors are available for ingress protection IP66 and IP68. IP66 connectors are fitted with a preinstalled universal safety clip which ensures a quick "push-in" installation. IP68 connectors for increased requirements will be delivered with a special conduit seal cap.

**Table 1 - PMAFIX / PMAFLEX conduit code**

Nominal width	UK sizes	PMA code
7	10	M
10	12	0
12	16	2
17	20	7
23	25	3
29	32	9
36	40	6
48	50	8

**Table 2 - Thread codes**

Thread metric	PMA code	Thread PG	PMA code
M12 x 1.5	M12	PG07	P07
M16 x 1.5	M16	PG09	P09
M20 x 1.5	M20	PG11	P11
M25 x 1.5	M25	PG13.5	P13
M32 x 1.5	M32	PG16	P16
M40 x 1.5	M40	PG21	P21
M50 x 1.5	M50	PG29	P29
M63 x 1.5	M63	PG36	P36
		PG42	P42
		PG48	P48

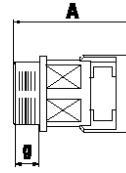

g = Thread length  
A = Overall length

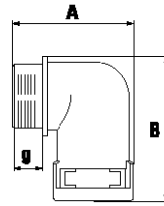

g = Thread length  
A x B = External dimensions

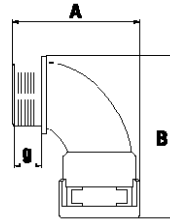

g = Thread length  
A x B = External dimensions

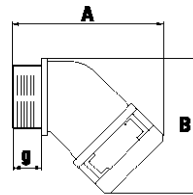

g = Thread length  
A x B = External dimensions

PMA-Program

Phone +49- (0) 22 03-96 49-800  
Fax +49- (0) 22 03-96 49-222

igus® GmbH  
51147 Cologne

Internet: [www.igus.de](http://www.igus.de)  
E-mail: [info@igus.de](mailto:info@igus.de)



## PMAFIX Connectors VW - 90° elbow, metric & PG

These PMAFIX connectors are used in a **wide range of applications**. Together with PMAFLEX conduits they offer the highest grade of safety and sealing. **Features:** ● High-grade formulated polyamide ● Self-extinguishing, free of halogen, phosphor and cadmium ● Excellent impact strength ● **Temperature range:** -40 °C to 105 °C; **Short-term** to 160 °C ● **Content of delivery IP66:** Fitting with pre-assembled universal safety clips (AFN2), **IP68:** Fitting with oval clips (OVN2), conduit and thread seal (NVN3, SVN4)

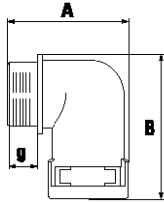

g = Thread length  
A x B = External dimensions

### Part No. structure metric

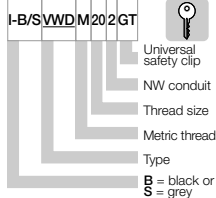

### Part No. structure PG

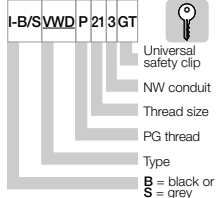

Part No. IP66	Part No. IP68	Thread		Fits to conduit size:		Thread length [mm]	External dim. [mm]
		metric	NW	metric			
I-□VWD-M12MGT	I-□VWV-M12M	M12 x 1.5	7	10	11.0	32.0 x 35.0	
I-□VWD-M120GT	I-□VWV-M120	M12 x 1.5	10	12	11.0	34.0 x 39.5	
I-□VWD-M160GT	I-□VWV-M160	M16 x 1.5	10	12	11.0	34.0 x 40.5	
I-□VWD-M162GT	I-□VWV-M162	M16 x 1.5	12	16	11.0	38.5 x 46.0	
I-□VWD-M202GT	I-□VWV-M202	M20 x 1.5	12	16	11.0	38.5 x 47.5	
I-□VWD-M207GT	I-□VWV-M207	M20 x 1.5	17	20	11.0	43.5 x 58.5	
I-□VWD-M253GT	I-□VWV-M253	M25 x 1.5	23	25	12.0	54.0 x 65.0	
I-□VWD-M329GT	I-□VWV-M329	M32 x 1.5	29	32	15.0	64.5 x 73.0	
I-□VWD-M406GT	I-□VWV-M406	M40 x 1.5	36	40	19.0	78.0 x 96.0	
I-□VWD-M508GT	I-□VWV-M508	M50 x 1.5	48	50	19.0	91.5 x 106.0	

Part No. IP66	Part No. IP68	Thread		Fits to conduit size:		Thread length [mm]	External dim. [mm]
		PG	NW	metric			
I-□VWD-P07MGT-11	I-□VWV-P07M	7	7	10	11.0	32.0 x 35.0	
I-□VWD-P070GT-11	I-□VWV-P070	7	10	12	11.0	34.0 x 39.5	
I-□VWD-P09MGT-11	-	9	7	10	11.0	32.0 x 36.5	
I-□VWD-P090GT-11	I-□VWV-P090	9	10	12	11.0	34.0 x 39.5	
I-□VWD-P092GT-11	I-□VWV-P092	9	12	16	11.0	38.5 x 44.5	
I-□VWD-P11MGT-11	-	11	7	10	11.0	32.0 x 38.0	
I-□VWD-P110GT-11	I-□VWV-P110	11	10	12	11.0	34.0 x 41.0	
I-□VWD-P112GT-11	I-□VWV-P112	11	12	16	11.0	38.5 x 46.0	
I-□VWD-P13MGT-11	-	13.5	7	10	11.0	32.0 x 39.5	
I-□VWD-P130GT-11	I-□VWV-P130	13.5	10	12	11.0	34.0 x 42.5	
I-□VWD-P132GT-11	I-□VWV-P132	13.5	12	16	11.0	38.5 x 47.5	
I-□VWD-P137GT-11	I-□VWV-P137	13.5	17	20	11.0	43.5 x 58.5	
I-□VWD-P167GT-11	I-□VWV-P167	16	17	20	11.0	43.5 x 58.5	
I-□VWD-P213GT	I-□VWV-P213	21	23	25	11.0	54.0 x 67.0	
I-□VWD-P299GT	I-□VWV-P299	29	29	32	12.0	61.5 x 74.5	
I-□VWD-P366GT	I-□VWV-P366	36	36	40	13.0	72.0 x 98.0	
I-□VWD-P488GT	I-□VWV-P488	48	48	50	13.0	85.5 x 111.0	

□ = Replace with "B" to order black or "S" to order grey  
For the sizes NW 17 to NW 48 curved elbows of type VB are available



**PMAFIX Connectors VN - straight, metric & PG**

These PMAFIX connectors are used in a wide range of applications. Together with PMAFLEX conduits they offer the highest grade of safety and sealing. **Features:** ● High-grade formulated polyamide ● Self-extinguishing, free of halogen, phosphor and cadmium ● Excellent impact strength ● **Temperature range:** -40 °C to 105 °C; **Short-term** to 160 °C ● **Content of delivery IP66:** Fitting with pre-assembled universal safety clips (AFN2), **IP68:** Fitting with oval clips (OVN2), conduit and thread seal (NVN3, SVN4)



PMA-Program

Part No. IP66	Part No. IP68	Thread metric	Fits to conduit size:		Thread length [mm]	Overall length [mm]
			NW	metric		
I-□VND-M12MGT	I-□VNV-M12M	M12 x 1.5	7	10	11.0	34.5
I-□VND-M120GT	I-□VNV-M120	M12 x 1.5	10	12	11.0	36.5
I-□VND-M160GT	I-□VNV-M160	M16 x 1.5	10	12	11.0	36.5
I-□VND-M162GT	I-□VNV-M162	M16 x 1.5	12	16	11.0	39.5
I-□VND-M202GT	I-□VNV-M202	M20 x 1.5	12	16	11.0	39.5
I-□VND-M207GT	I-□VNV-M207	M20 x 1.5	17	20	11.0	47.5
I-□VND-M257GT	I-□VNV-M257	M25 x 1.5	17	20	12.0	48.5
I-□VND-M253GT	I-□VNV-M253	M25 x 1.5	23	25	12.0	52.0
I-□VND-M323GT	I-□VNV-M323	M32 x 1.5	23	25	15.0	55.5
I-□VND-M329GT	I-□VNV-M329	M32 x 1.5	29	32	15.0	56.0
I-□VND-M409GT	I-□VNV-M409	M40 x 1.5	29	32	19.0	60.0
I-□VND-M406GT	I-□VNV-M406	M40 x 1.5	36	40	19.0	72.5
I-□VND-M506GT	I-□VNV-M506	M50 x 1.5	36	40	19.0	72.0
I-□VND-M508GT	I-□VNV-M508	M50 x 1.5	48	50	19.0	72.5
I-□VND-M638GT	I-□VNV-M638	M63 x 1.5	48	50	19.0	72.0

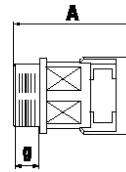

g = Thread length  
A = Overall length

Part No. IP66	Part No. IP68	Thread PG	Fits to conduit size:		Thread length [mm]	Overall length [mm]
			NW	metric		
I-□VND-P07MGT-11	I-□VNV-P07M	7	7	10	11.0	34.5
I-□VND-P070GT-11	I-□VNV-P070	7	10	12	11.0	36.5
I-□VND-P072GT-11	-	7	12	16	11.0	39.0
I-□VND-P09MGT-11	I-□VNV-P09M	9	7	10	11.0	34.5
I-□VND-P090GT-11	I-□VNV-P090	9	10	12	11.0	36.5
I-□VND-P092GT-11	I-□VNV-P092	9	12	16	11.0	39.0
I-□VND-P097GT-11	I-□VNV-P097	9	17	20	11.0	47.5
I-□VND-P11MGT-11	I-□VNV-P11M	11	7	10	11.0	34.5
I-□VND-P110GT-11	I-□VNV-P110	11	10	12	11.0	36.5
I-□VND-P112GT-11	I-□VNV-P112	11	12	16	11.0	39.0
I-□VND-P117GT-11	I-□VNV-P117	11	17	20	11.0	47.5
I-□VND-P13MGT-11	-	13.5	7	10	11.0	34.5
I-□VND-P130GT-11	I-□VNV-P130	13.5	10	12	11.0	36.5
I-□VND-P132GT-11	I-□VNV-P132	13.5	12	16	11.0	39.0
I-□VND-P137GT-11	I-□VNV-P137	13.5	17	20	11.0	47.5
I-□VND-P160GT-11	-	16	10	12	11.0	36.5
I-□VND-P162GT-11	I-□VNV-P162	16	12	16	11.0	39.0
I-□VND-P167GT-11	I-□VNV-P167	16	17	20	11.0	47.5
I-□VND-P163GT-11	I-□VNV-P163	16	23	25	11.0	51.0
I-□VND-P213GT	I-□VNV-P213	21	23	25	12.0	52.0
I-□VND-P299GT	I-□VNV-P299	29	29	32	12.0	53.0
I-□VND-P296GT	I-□VNV-P296	29	36	40	12.0	67.5
I-□VND-P366GT	I-□VNV-P366	36	36	40	13.0	66.0
I-□VND-P368GT	-	36	48	50	13.0	68.5
I-□VND-P428GT	I-□VNV-P428	42	48	50	13.0	68.5
I-□VND-P488GT	I-□VNV-P488	48	48	50	13.0	66.5

□ = Replace with "B" to order black or "S" to order grey

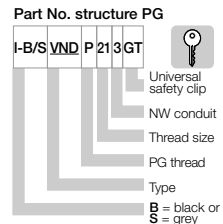
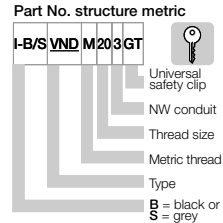

Phone +49- (0) 22 03-96 49-800  
Fax +49- (0) 22 03-96 49-222

igus® GmbH  
51147 Cologne

Internet: [www.igus.de](http://www.igus.de)  
E-mail: [info@igus.de](mailto:info@igus.de)

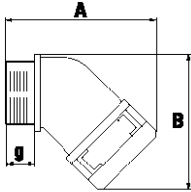

g = Thread length  
 A x B = External dimensions

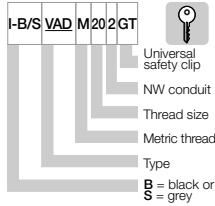
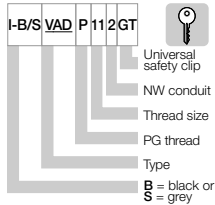
**Part No. structure metric**

**Part No. structure PG**

**PMAFIX Connectors VA - 45° elbow, metric & PG**

These PMAFIX connectors are used in a **wide range of applications**. Together with PMAFLEX conduits they offer the highest grade of safety and sealing. **Features:** ● High-grade formulated polyamide, thread made of nickel-plated brass ● Self-extinguishing, free of halogen, phosphor and cadmium ● Excellent impact strength ● **Temperature range:** -40 °C to 105 °C; **Short-term** to 160 °C ● **Content of delivery IP66:** Fitting with pre-assembled universal safety clips (AFN2), **IP68:** Fitting with oval clips (OVN2), conduit and thread seals (NVN3, SVN4)

Part No. IP66	Part No. IP68	Thread metric	Fits to conduit size:		Thread length [mm]	External dim. [mm]
			NW	metric		
I-□ VAD-M120GT	-	M12 x 1.5	10	12	11.0	43.5 x 37.0
I-□ VAD-M160GT	I-□ VAV-M160	M16 x 1.5	10	12	11.0	43.5 x 38.0
I-□ VAD-M162GT	I-□ VAV-M162	M16 x 1.5	12	16	11.0	48.0 x 40.0
I-□ VAD-M202GT	I-□ VAV-M202	M20 x 1.5	12	16	11.0	48.0 x 41.5
I-□ VAD-M207GT	I-□ VAV-M207	M20 x 1.5	17	20	11.0	55.5 x 51.5
I-□ VAD-M253GT	I-□ VAV-M253	M25 x 1.5	23	25	12.0	65.0 x 58.5
I-□ VAD-M329GT	I-□ VAV-M329	M32 x 1.5	29	32	15.0	73.5 x 66.5
I-□ VAD-M406GT	I-□ VAV-M406	M40 x 1.5	36	40	19.0	92.5 x 85.5
I-□ VAD-M506GT	I-□ VAV-M506	M50 x 1.5	36	40	19.0	100.0 x 89.5
I-□ VAD-M508GT	I-□ VAV-M508	M50 x 1.5	48	50	19.0	100.0 x 96.0
I-□ VAD-M638GT	I-□ VAV-M638	M63 x 1.5	48	50	19.0	100.0 x 104.0

Part No. IP66	Part No. IP68	Thread PG	Fits to conduit size:		Thread length [mm]	External dim. [mm]
			NW	metric		
I-□ VAD-P090GT	I-□ VAV-P090	9	10	12	11.0	43.5 x 37.0
I-□ VAD-P112GT	I-□ VAV-P112	11	12	16	11.0	48.0 x 40.0
I-□ VAD-P132GT	I-□ VAV-P132	13.5	12	16	11.0	48.0 x 41.5
I-□ VAD-P137GT	I-□ VAV-P137	13.5	17	20	11.0	55.0 x 50.0
I-□ VAD-P167GT	I-□ VAV-P167	16	17	20	11.0	55.0 x 51.5
I-□ VAD-P213GT	I-□ VAV-P213	21	23	25	12.0	67.0 x 59.0
I-□ VAD-P299GT	I-□ VAV-P299	29	29	32	12.0	69.0 x 67.0
I-□ VAD-P366GT	I-□ VAV-P366	36	36	40	13.0	86.0 x 86.0
I-□ VAD-P488GT	I-□ VAV-P488	48	48	50	13.0	93.0 x 99.0

□ = Replace with "B" to order black or "S" to order grey



**PMAFIX Connectors VB - 90° curved elbow, metric & PG**

These PMAFIX connectors are used in a **wide range of applications**. Together with PMAFLEX conduits they offer the highest grade of safety and sealing. **Features:** ● High-grade formulated polyamide ● Self-extinguishing, free of halogen, phosphor and cadmium ● Excellent impact strength ● **Temperature range:** -40 °C to 105 °C; **Short-term** to 160 °C ● **IP66:** Fitting with pre-assembled universal safety clips (AFN2) ● **IP68:** Fitting with oval clips (OVN2), conduit and thread seal (NVN3,SVN4)



Part No. IP66	Part No. IP68	Thread metric	Fits to conduit size:		Thread length [mm]	External dim. [mm]
			NW	metric		
I-□VBD-M207GT	I-□VBV-M207	M20 x 1.5	17	20	11.0	47.5 x 73.0
I-□VBD-M257GT	I-□VBV-M257	M25 x 1.5	17	20	12.0	48.5 x 76.0
I-□VBD-M253GT	I-□VBV-M253	M25 x 1.5	23	25	12.0	57.5 x 83.0
I-□VBD-M323GT	I-□VBV-M323	M32 x 1.5	23	25	15.0	61.0 x 87.5
I-□VBD-M329GT	I-□VBV-M329	M32 x 1.5	29	32	15.0	70.5 x 93.0
I-□VBD-M409GT	I-□VBV-M409	M40 x 1.5	29	32	19.0	74.5 x 98.5
I-□VBD-M406GT	I-□VBV-M406	M40 x 1.5	36	40	19.0	85.0 x 121.0
I-□VBD-M506GT	I-□VBV-M506	M50 x 1.5	36	40	19.0	85.0 x 125.0
I-□VBD-M508GT	I-□VBV-M508	M50 x 1.5	48	50	19.0	98.5 x 130.0
I-□VBD-M638GT	I-□VBV-M638	M63 x 1.5	48	50	19.0	98.5 x 138.0

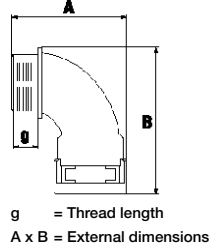

Part No. IP66	Part No. IP68	Thread PG	Fits to conduit size:		Thread length [mm]	External dim. [mm]
			NW	metric		
I-□VBD-P167GT	I-□VBV-P167	16	17	20	11.0	47.4 x 73.0
I-□VBD-P213GT	I-□VBV-P213	21	23	25	12.0	57.5 x 85.0
I-□VBD-P299GT	I-□VBV-P299	29	29	32	12.0	67.5 x 96.0
I-□VBD-P366GT	I-□VBV-P366	36	36	40	13.0	79.0 x 123.0
I-□VBD-P488GT	I-□VBV-P488	48	48	50	13.0	92.5 x 135.0

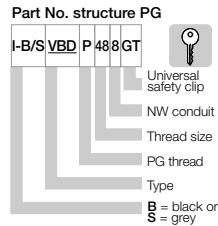
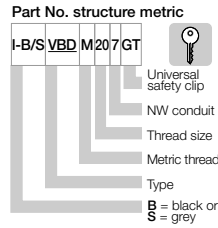

□ = Replace with "B" to order black or "S" to order grey. For smaller conduit sizes NW 07 to NW 12 appropriate standard elbows of type VW are available

**PMAFIX Connectors VO - flange 90°**

These PMAFIX connectors are used in a **wide range of applications**. Together with PMAFLEX conduits they offer the highest grade of safety and sealing. **Features:** ● IP66: Fitting with pre-assembled universal safety clips (AFN2), flange seal (OR) ● IP68: Fitting with oval clips (OVN2), conduit and flange seal (NVN3, OR)



Part No. IP66	Part No. IP68	Fits to conduit size:		Dimensions width x length x depth	Fixing screws
		NW	metric		
I-□VOD-P167GT	I-□VOV-P167	17	20	45.0 x 66.0 x 34.0	2 x M5
I-□VOD-P213GT	I-□VOV-P213	23	25	63.0 x 70.0 x 42.0	2 x M6
I-□VOD-P299GT	I-□VOV-P299	29	32	67.0 x 78.0 x 48.0	4 x M6
I-□VOD-P366GT	I-□VOV-P366	36	40	85.0 x 102.0 x 64.0	4 x M6
I-□VOD-P488GT	I-□VOV-P488	48	50	86.0 x 119.0 x 76.0	4 x M6

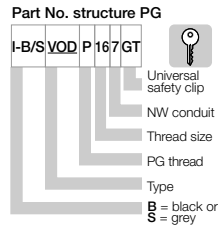

□ = Replace with "B" to order black or "S" to order grey

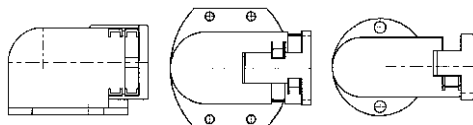

PMA-Program

Phone +49- (0) 22 03-96 49-800  
Fax +49- (0) 22 03-96 49-222

igus® GmbH  
51147 Cologne

Internet: [www.igus.de](http://www.igus.de)  
E-mail: [info@igus.de](mailto:info@igus.de)





### PMAFIX FH-0 - one-piece system supports

The **one-piece PMACLIP** system support is designed for fixation of **PMAFLEX** conduits. This product can be used in all **machine and installation applications** for easy assembly of the PMA system.

**Features:** ● High-grade formulated polyamide ● Self-extinguishing, free of halogen, phosphor and cadmium ● Excellent impact strength ● **Temperature range:** -40 °C to 105 °C; **Short-term** 160 °C

Part No. black	Part No. grey	Fits to conduit size:		Dimensions width x length x depth	Fixing screw
		NW	metric		
I-BFH-07-0	I-SFH-07-0	7	10	17.0 x 21.5 x 20.0	1 x M4
I-BFH-10-0	I-SFH-10-0	10	12	20.5 x 24.5 x 20.0	1 x M5
I-BFH-12-0	I-SFH-12-0	12	16	24.0 x 27.0 x 20.0	1 x M5
I-BFH-17-0	I-SFH-17-0	17	20	30.0 x 34.0 x 20.0	1 x M6
I-BFH-23-0	I-SFH-23-0	23	25	38.5 x 42.0 x 20.0	1 x M6
I-BFH-29-0	I-SFH-29-0	29	32	45.5 x 48.0 x 20.0	1 x M6
I-BFH-36-0	I-SFH-36-0	36	40	55.5 x 56.0 x 20.0	1 x M6
I-BFH-48-0	I-SFH-48-0	48	50	67.5 x 68.0 x 20.0	1 x M6

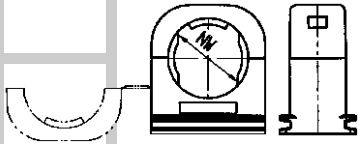

### PMA MN - hexagonal lock nuts, metric & PG

These hexagonal lock nuts are suitable for a wide range of applications. High torque guarantees a safe connection of the system. **Features:** ● Polyamide glass fiber reinforced ● **Temperature range:** -40 °C to 105 °C; **Short-term** 150 °C

Part No. black	Part No. grey	Fits to thread:	Wrench size	Dimensions height
		metric		
I-BMN-M12	I-GMN-M12	M12 x 1.5	17.0	5.0
I-BMN-M16	I-GMN-M16	M16 x 1.5	22.0	5.0
I-BMN-M20	I-GMN-M20	M20 x 1.5	27.0	6.0
I-BMN-M25	I-GMN-M25	M25 x 1.5	32.0	6.0
I-BMN-M32	I-GMN-M32	M32 x 1.5	41.0	7.0
I-BMN-M40	I-GMN-M40	M40 x 1.5	50.0	7.0
I-BMN-M50	I-GMN-M50	M50 x 1.5	60.0	8.0
I-BMN-M63	I-GMN-M63	M63 x 1.5	75.0	8.0

Part No. black	Part No. grey	Fits to thread:	Wrench size	Dimensions height
		PG		
I-BMN-07	I-GMN-07	7	19.0	5.0
I-BMN-09	I-GMN-09	9	22.0	5.0
I-BMN-11	I-GMN-11	11	24.0	5.0
I-BMN-13	I-GMN-13	13.5	27.0	6.0
I-BMN-16	I-GMN-16	16	30.0	6.0
I-BMN-21	I-GMN-21	21	36.0	7.0
I-BMN-29	I-GMN-29	29	46.0	7.0
I-BMN-36	I-GMN-36	36	60.0	8.0
I-BMN-48	I-GMN-48	48	70.0	8.0

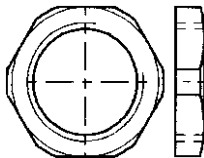

### PMA SGB - tube clamps

These tube clamps are used for the mounting and smooth connection to the PMA conduits in the general machine and installation constructions. They are especially suitable for the mounting of static conduits.

**Features:** ● Galvanized steel according to DIN 3016 ● Elastomer free of halogen ● **Temperature range:** -50 °C bis 105 °C



Part No.	Fits to conduit size	Fits to conduit size	Dimensions	Fixing screw
	NW	metric	width [mm]	
I-SGB-07	7	10	13.0	1 x M4
I-SGB-09	10	12	13.0	1 x M4
I-SGB-11	12	16	13.0	1 x M4
I-SGB-16	17	20	16.0	1 x M5
I-SGB-21	23	25	16.0	1 x M5
I-SGB-29	29	32	19.0	1 x M6
I-SGB-36	36	40	19.0	1 x M6
I-SGB-48	48	50	19.0	1 x M6

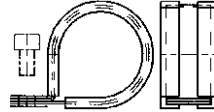

### PMA 514 - plug screws, metric & PG

These plug screws are suitable for an accurate termination where no thread holes in casing and distribution boxes are needed. **Features:** ● Product with metric thread: **PA-GF** - Product with PG thread: **PS** ● Free of halogen, phosphor and cadmium ● IP54 ● **Temperature range:** -20 °C to 60 °C; **Short-term** 100 °C



Part No.	Fits to thread	Outside	Total length	Thread length
	metric	Ø [mm]	[mm]	[mm]
I-514-M12	M12 x 1.5	15.0	8.0	6.0
I-514-M16	M16 x 1.5	20.0	9.0	6.0
I-514-M20	M20 x 1.5	24.0	9.5	6.0
I-514-M25	M25 x 1.5	30.0	11.5	8.0
I-514-M32	M32 x 1.5	37.0	12.0	8.0
I-514-M40	M40 x 1.5	46.0	13.0	8.0
I-514-M50	M50 x 1.5	56.0	15.0	10.0
I-514-M63	M63 x 1.5	70.0	17.0	12.0

Part No.	Fits to thread	Outside	Total length	Thread length
	PG	Ø [mm]	[mm]	[mm]
I-514-07	7	15.0	8.0	6.0
I-514-09	9	19.0	9.5	6.5
I-514-11	11	22.0	10.0	6.5
I-514-13	13.5	25.0	10.0	6.5
I-514-16	16	27.0	10.0	6.5
I-514-21	21	33.0	12.0	8.0
I-514-29	29	44.0	11.5	8.0
I-514-36	36	55.0	14.0	10.0
I-514-48	48	69.0	16.0	12.0

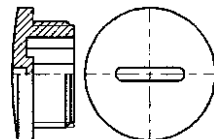



igus® E-ChainSystems®

<b>Standard Corrugated Conduits</b>						
<b>Products</b>		<b>PCL PA6</b>	<b>CYL PA6</b>	<b>VOH PA6</b>	<b>PIS PA12</b>	<b>FH</b>
<b>Tube size:</b>		Very flexible, medium wall	Very flexible, medium wall	Flexible, very heavy	Highly flexible medium wall	PMACLIP - one-piece system support
<b>metric</b>	<b>width [mm]</b>	<b>corrugated conduits</b>	<b>corrugated conduits</b>	<b>corrugated conduits</b>	<b>corrugated conduits</b>	
10	07	PCLT-07* -	CYLT-07* -	VDHD-07* -	PIST-07* -	*FH-07-0
12	10	PCLT-10* -	CYLT-10* -	VOHD-10* -	PIST-10* -	*FH-10-0
16	12	PCLT-12* -	CYLT-12* -	VOHD-12* -	PIST-12* -	*FH-12-0
20	17	PCLT-17* PCLG-17*	CYLT-17* -	- VOHG-17*	PIST-17* PISG-17*	*FH-17-0
25	23	PCLT-23* PCLG-23*	CYLT-23* CYLG-23*	- VOHG-23*	PIST-23* PISG-23*	*FH-23-0
32	29	PCLT-29* PCLG-29*	CYLT-29* CYLG-29*	- VOHG-29*	PIST-29* PISG-29*	*FH-29-0
40	36	PCLT-36* PCLG-36*	CYLT-36* CYLG-36*	- VOHG-36*	PIST-36* PISG-36*	*FH-36-0
50	48	PCLT-48* PCLG-48*	CYLT-48* CYLG-48*	- VOHG-48*	PIST-48* PISG-48*	*FH-48-0

\* = replaced by "B" for black or "S" for gray

T or D = fine profile

G = coarse profile

Phone +49- (0) 22 03-96 49-800  
Fax +49- (0) 22 03-96 49-222

<b>Standard Corrugated Conduits</b>						
<b>Products</b>		<b>PCL PA6</b>	<b>CYL PA6</b>	<b>VOH PA6</b>	<b>PIS PA12</b>	<b>FH</b>
<b>Tube size:</b>		Very flexible, medium wall	Very flexible, medium wall	Flexible, very heavy	Highly flexible medium wall	PMACLIP - one-piece system support
<b>metric</b>	<b>width [mm]</b>	<b>corrugated conduits</b>	<b>corrugated conduits</b>	<b>corrugated conduits</b>	<b>corrugated conduits</b>	
10	07	PCLT-07* -	CYLT-07* -	VDHD-07* -	PIST-07* -	*FH-07-0
12	10	PCLT-10* -	CYLT-10* -	VOHD-10* -	PIST-10* -	*FH-10-0
16	12	PCLT-12* -	CYLT-12* -	VOHD-12* -	PIST-12* -	*FH-12-0
20	17	PCLT-17* PCLG-17*	CYLT-17* -	- VOHG-17*	PIST-17* PISG-17*	*FH-17-0
25	23	PCLT-23* PCLG-23*	CYLT-23* CYLG-23*	- VOHG-23*	PIST-23* PISG-23*	*FH-23-0
32	29	PCLT-29* PCLG-29*	CYLT-29* CYLG-29*	- VOHG-29*	PIST-29* PISG-29*	*FH-29-0
40	36	PCLT-36* PCLG-36*	CYLT-36* CYLG-36*	- VOHG-36*	PIST-36* PISG-36*	*FH-36-0
50	48	PCLT-48* PCLG-48*	CYLT-48* CYLG-48*	- VOHG-48*	PIST-48* PISG-48*	*FH-48-0

\* = replaced by "B" for black or "S" for gray

T or D = fine profile

G = coarse profile

igus® GmbH  
51147 Cologne

<b>JUMBO Corrugated Conduits PMAGRIP</b>						
<b>Products</b>		<b>PCLG PA6</b>	<b>PIHG PA12</b>	<b>BGG</b>	<b>BGO</b>	<b>SGS</b>
<b>Tube size:</b>		Very flexible, medium wall	Highly flexible medium wall	PMAGRIP- straight	PMAGRIP- 90° angle	PMAGRIP- tube clamps
<b>Width [mm]</b>		<b>corrugated conduits</b>	<b>corrugated conduits</b>			
56		PCLG-56*	PIHG-56*	*GG-56	*GO-56	SGS-56
70		PCLG-70*	PIHG-70*	*GG-70	*GO-70	SGS-70
95		PCLG-95*	PIHG-95*	*GG-95	*GO-95	SGS-95
125		PCLG-125*	PIHG-125*	*GG-125	-	SGS-125

\* = replaced by "B" for black or "S" for gray

T or D = fine profile

G = coarse profile

Internet: [www.igus.de](http://www.igus.de)  
E-mail: [info@igus.de](mailto:info@igus.de)



<b>PMAFIX</b>						
<b>Products</b>	<b>IP66 - VN 9A</b>	<b>IP66 - VA 9A</b>	<b>IP66 - VW 9A</b>	<b>IP66 - VB</b>	<b>IP68 - VN2 9A</b>	<b>MN</b>
Thread	PMAFIX	PMAFIX	PMAFIX	PMAFIX	Straight with	PMA
Typ	straight	45° angle	90° angle	90° elbow angle	strain relief	hexagonal lock nuts
M12x1.5	*VND-M12MGT	-	*VWD-M12MGT	-	-	*MN-M12
M12x1.5	*VND-M120GT	*VAD-M120GT	*VWD-M120GT	-	-	*MN-M12
M16x1.5	*VND-M162GT	*VAD-M162GT	*VWD-M162GT	-	*VNZ-M162S	*MN-M16
M20x1.5	*VND-M207GT	*VAD-M207GT	*VWD-M207GT	*VBD-M207GT	*VNZ-M207S	*MN-M20
M25x1.5	*VND-M253GT	*VAD-M253GT	*VWD-M253GT	*VBD-M253GT	*VNZ-M253S	*MN-M25
M32x1.5	*VND-M329GT	*VAD-M329GT	*VWD-M329GT	*VBD-M329GT	*VNZ-M329S	*MN-M32
M40x1.5	*VND-M406GT	*VAD-M406GT	*VWD-M406GT	*VBD-M406GT	*VNZ-M406S	*MN-M40
M50x1.5	*VND-M508GT	*VAD-M508GT	*VWD-M508GT	*VBD-M508GT	*VNZ-M508S	*MN-M50

\* = replaced by "B" for black or "S" for gray

<b>PMAFIX</b>						
<b>Products</b>	<b>IP66 - VOD 9A</b>	<b>IP66 - VY 9A</b>	<b>IP66 - FT/VT 9A</b>	<b>IP66 - FV 9A</b>	<b>SGB</b>	
Tube size:	PMAFIX	PMAFIX	PMAFIX	PMAFIX	PMAFIX-	
metric	flange 90°	Y-distribution	T-distribution	V-distribution	tube clamps	
width [mm]		piece	piece	piece		
10	07	-	-	-	SGB-07	
12	10	-	*VYD-100707GT	*FTD-101010GT	SGB-09	
16	12	-	*VYD-121010GT	*FTD-121212GT	SGB-11	
20	17	*VOD-P167GT	*VYD-171212GT	*FTD-171717GT	SGB-16	
25	23	*VOD-P213GT	*VYD-231717GT	*FTD-232323GT	SGB-21	
32	29	*VOD-P299GT	*VYD-292323GT	*FTD-292929GT	SGB-29	
40	36	*VOD-P366GT	*VYD-362929GT	*FTD-363636GT	SGB-36	
50	48	*VOD-P488GT	*VYD-483636GT	-	SGB-48	

\* = replaced by "B" for black or "S" for gray

**PMAFIX - Order example**

XXXX-10 07 07 XX

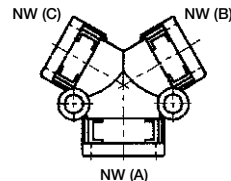
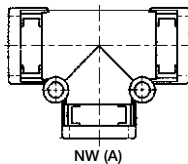
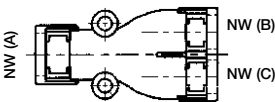

Please note: Since January 2003 are only complete packaging units available on request!

PMA-Program

Phone +49- (0) 22 03-96 49-800  
Fax +49- (0) 22 03-96 49-222

igus® GmbH  
51147 Cologne

Internet: [www.igus.de](http://www.igus.de)  
E-mail: [info@igus.de](mailto:info@igus.de)

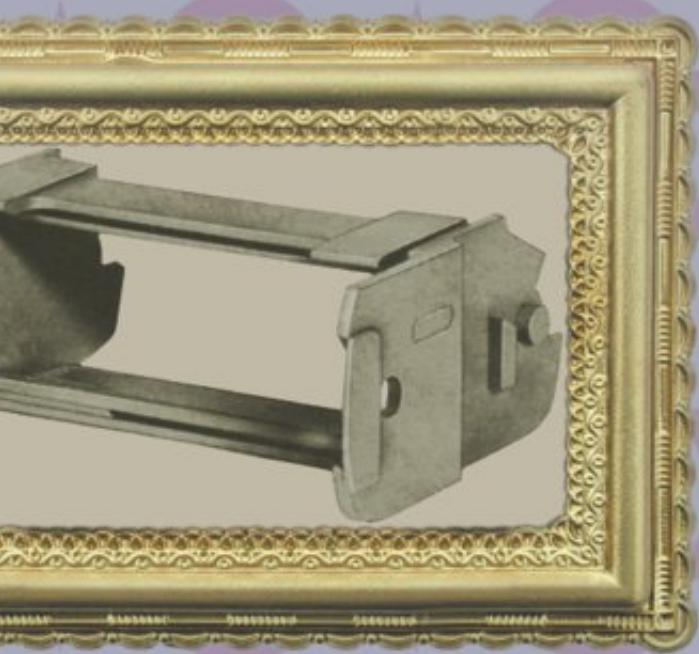

# igus<sup>®</sup> classic

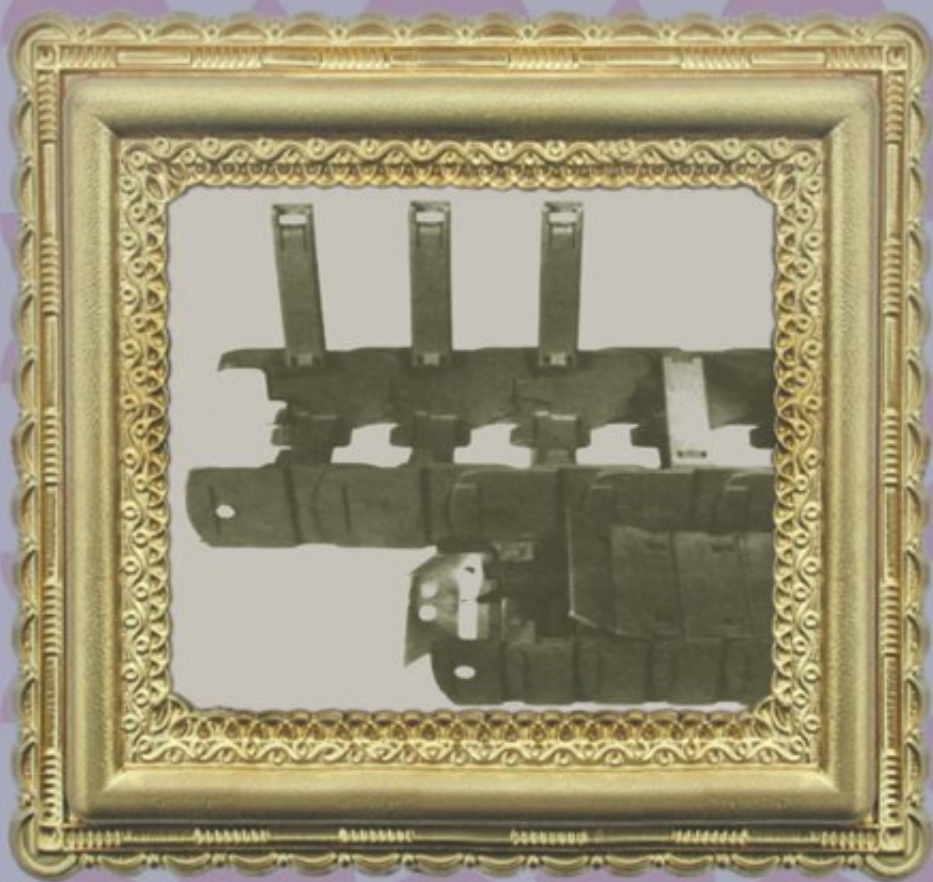

## Older products are still available!

For new designs, we recommend using the newer and more advanced E-Chain® Series. The following pages show our recommendations of which ones to use. The complete product range, incl. all mounting variations and guide troughs for the "Classic"-series are available on a continuous basis. The complete program is available online and can be accessed under the respective link for the series. This chapter explains line extensions and special solutions/special series of the E-Chain® for special applications.

### Selection table

Series		Inner height <i>hi</i> [mm]	Inner width <i>Bi</i> [mm]	Outer width <i>Ba</i> [mm]	Outer height <i>ha</i> [mm]	Bending radius <i>R</i> [mm]	Unsupported length max. [m]	Page
<b>"Classic"-series</b>								
15 classic	Zipper	17	15 - 50	26 - 61	24	38 - 180	1,20	12.4
10 classic	E2 mini	18	15 - 50	26 - 61	23	28 - 180	1,20	12.6
B15 classic	E2 mini	17	15 - 50	26 - 61	24	38 - 180	1,20	12.8
200/240/250	E2 medium	25	25 - 125	41 - 141	35	55 - 250	2,00	12.10
26/27i/27	E2 medium	35	50 - 200	66 - 219	50	63 - 250	2,20	12.12
340/350	E2 medium	45	50 - 250	70 - 270	64	75 - 300	2,50	12.14
20/25	E2 medium	25	11 - 103	27 - 118	34	55 - 250	2,00	12.18
30/35/36	E2 medium	45	75 - 175	93 - 195	64	75 - 300	2,50	12.20
R58 classic	E2 Tubes	35	50 - 75	66 - 92	50	75 - 250	2,30	12.22
R68 classic	E2 Tubes	45	75 - 175	93 - 196	64	100 - 300	2,50	12.24
140/141/R188	E4/light	56	50 - 600	76 - 626	84	135 - 500	4,00	12.26
142/143	E4/light	62	50 - 400	76 - 426	84	135 - 500	4,00	12.28
150/151/R198	E4/light	80	50 - 600	80 - 630	108	150 - 500	4,50	12.30
22/23/R76	E4/0	28	40 - 300	60 - 320	42	55 - 250	2,10	12.32
28/29/R77	E4/0	32	50 - 400	73 - 423	54	63 - 300	2,50	12.34
38/39/R78	E4/0	42	50 - 400	77 - 427	64	75 - 350	3,25	12.36
40/41/R88	E4/0	56	50 - 600	86 - 636	84	135 - 500	4,50	12.38
50/51/R98	E4/0	80	50 - 600	100 - 650	108	150 - 1000	6,00	12.40

### Line extensions and special solutions

38022	E4/00	52	50 - 400	76 - 426	64	75 - 350	3,80	12.42
383822	E4/4	52	50 - 400	77 - 427	64	75 - 350	3,80	12.44
3822	E4/0	52	50 - 400	77 - 427	64	75 - 350	3,25	12.46
E-Band		25,5	25	36	36	45-200	1,50	12.50

### Appendix

Fax forms from...	12.53
Terminology index	12.62
igus® addresses	12.64



**Classic-series quicklinks**

Quicklinks for more information or additional functions can be found on each product page. "Visit" your selected product online by clicking on ► [www.igus.de/en/140](http://www.igus.de/en/140) to find more information, such as detailed interior separation and mounting options, 3-D CAD, DXF, and PDF-files for downloading, application examples, and much more; everything you need to know about your igus® product.

The screenshot shows the product page for the Classic-series quicklinks. It features a large image of the product on the left. To the right, there is a list of features under the heading 'Hier können Sie die E-ChainSysteme individuell konfigurieren...' and a list of options under 'Wählen Sie die E-ChainSysteme...'. The options include: 1. 100% Anschlusslösungen, 2. Anschlusslösungen oben oder gesteuert einziehbar, 3. 0.800 (Dichtung einziehbar), 4. R.100 (Stöße einziehbar), 5. 0.800 (Stöße einziehbar), 6. Zugentlastungselemente integrierbar, 7. 140/141 (Stöße einziehbar einziehbar). Below this, there are two columns of text: 'Ladefähige Innenketten R: 50 bis 600 mm' and 'Ladefähige Außenketten R: 100 bis 600 mm'. On the right side of the page, there are sections for 'Wählen Sie die E-ChainSysteme...', 'Wählen Sie die E-ChainSysteme...', and 'Wählen Sie die E-ChainSysteme...'. At the bottom right, there is a section for 'Find online all information about the igus®-classics series'.

Find online all information about the igus®-classics series

The screenshot shows the online configurator for the Classic-series quicklinks. It features a form with various input fields for dimensions and specifications. The fields include: 'Einbaubreite', 'Anzahl der Antriebe', 'Einbaubreite B [mm]', 'Nennbreite R [mm]', 'Verfahren [mm]', 'Hakenhöhe [mm]', 'Anzahl Haken pro U', 'Außenbreite B<sub>2</sub> [mm]', 'n° [mm]', 'g [mm]', 'H [mm]', 'h<sub>1</sub> [mm]', 'h<sub>2</sub> [mm]', 'Anzahl der Antriebe', 'Anzahl der Antriebe', 'Anzahl der Antriebe', 'Anzahl der Antriebe'. Below the form, there is a diagram of the chain and a graph showing the relationship between the length of the chain and the number of links. On the right side, there is a section for '2. Varianten Anschlusslösungen' and a list of options for 'Anzahl der Antriebe'.

Configure your E-Chain® online. Easy takeover into the part list

The screenshot shows the online configurator for the Classic-series quicklinks, displaying a 3D model of the chain. The model is shown in a perspective view, highlighting its curved shape and the internal components. On the left side, there is a list of options for 'Anzahl der Antriebe'. Below the model, there is a section for 'Anzahl der Antriebe' and a list of options for 'Anzahl der Antriebe'. At the bottom, there is a section for 'Generate quick and easy a 3D-file'.

Generate quick and easy a 3D-file

For new constructions:  
**Series 15 "Zipper"**  
▶ page 4.18

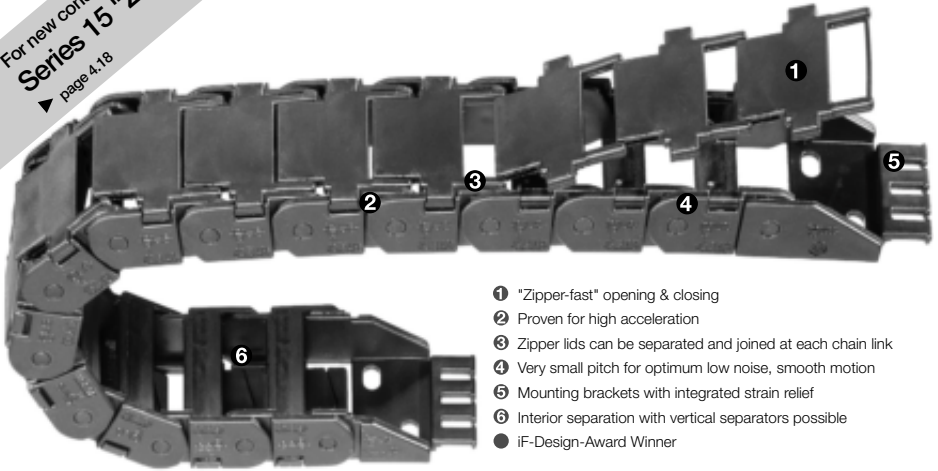

- 1 "Zipper-fast" opening & closing
- 2 Proven for high acceleration
- 3 Zipper lids can be separated and joined at each chain link
- 4 Very small pitch for optimum low noise, smooth motion
- 5 Mounting brackets with integrated strain relief
- 6 Interior separation with vertical separators possible
- iF-Design-Award Winner



Phone +49- (0) 22 03-96 49-800  
Fax +49- (0) 22 03-96 49-222

igus® GmbH  
51147 Cologne

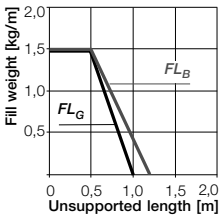

Length of travel S [m]  
0 1,0 2,0 3,0 4,0

Unsupported length

FL<sub>G</sub> = with straight upper run

FL<sub>B</sub> = with permitted sag

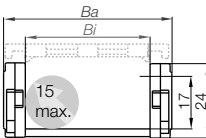
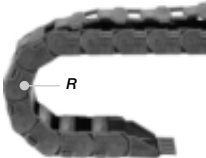
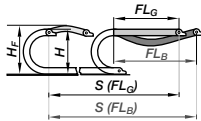

Series 15 classic - zip-open along the outer radius

Part No.	Bi [mm]	Ba [mm]	R [mm] Bending Radii
15.1. <input type="text"/> .0	15	26	038 048 075
15.2. <input type="text"/> .0	25	36	110 125 145
15.3. <input type="text"/> .0	38	49	180
15.4. <input type="text"/> .0	50	61	Radii for all widths!

Supplement Part No. with required radius. Example: 15.1. .0  
Bending radii listed above can be combined with every chain width!

Part No. structure

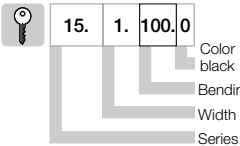

- Order example 2,0 m complete E-Chain®**  
(indicate chain-lengths or number of links)
- 2,0 m (66 links) **Series 15.1.100.0**
  - + 2 separators **152** assembled each 2<sup>nd</sup> link
  - + 1 set mounting brackets + **tiwrap plates 101.12PZ**

Pitch = 30,5 mm    Links per m = 33    Chain length =  $\frac{S}{2} + K$

R	038	048	075	110	125	145	180
H	100	120	175	245	275	315	385
D	90	120	145	170	190	225	279
K	185	215	300	410	455	520	630

The required clearance height is  $H_F = H + 20$  mm (with 1 kg/m fill weight). Please consult igus® if space is particularly restricted.

## Installation Dimensions

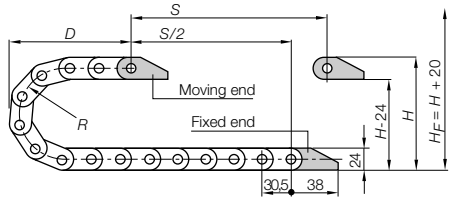

Zipper classic  
Inner height: 17 mm

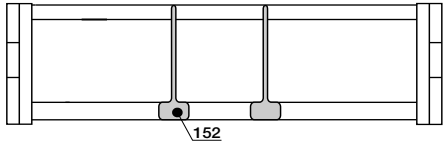

## Vertical separators

unassembled	151
assembled	152



## Interior Separation



10...1P(Z)  
Moving end

10...2P(Z)  
Fixed end

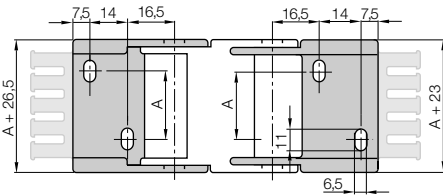

Moving end (with bore)  
10...1P(Z)

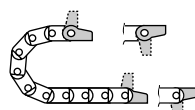

10...2P(Z)  
Fixed end (with pin)

## Mounting Brackets

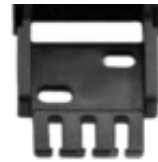

Polymer with or without strain relief tiwrap plates

For E-Chain®	Part No. full set with tiwrap plate	Part No. full set without tiwrap plate	Dimension A [mm]
15.1. ▶	101.12PZ	101.12P	-
15.2. ▶	102.12PZ	102.12P	10
15.3. ▶	103.12PZ	103.12P	23
15.4. ▶	104.12PZ	104.12P	35

Tiwrap plates are possible at the moving end and/or the fixed end!

## Part No. structure

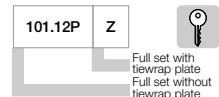

Full set, for both ends:

101. 12 PZ (+ tiwrap plates)

Single-part order:

101. 1 PZ (+ tiwrap plates)

Mounting bracket with bore

101. 2 PZ (+ tiwrap plates)

Mounting bracket with pin



One-piece or two-piece steel mounting brackets possible

## Additional Features

For more features

▶ see link below



www



▶ chapter 9

For new constructions:  
**Series 10 E2 mini**  
▶ page 5.40

E2 mini | Series 10 classic

igus® E-ChainSystems®

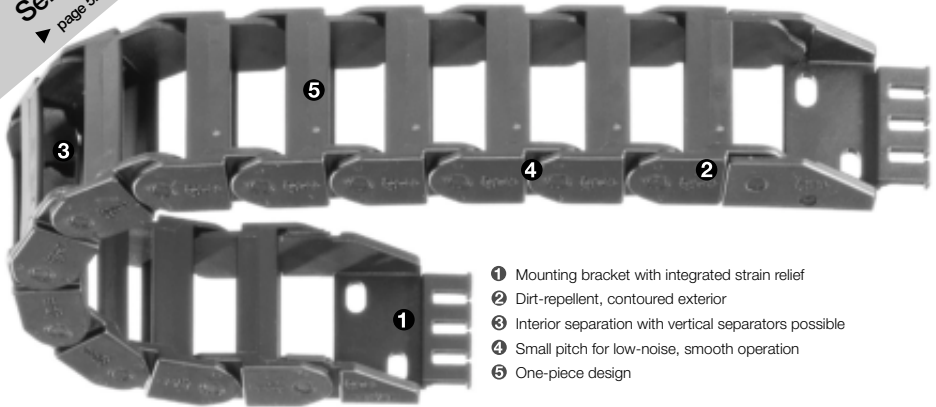

- ❶ Mounting bracket with integrated strain relief
- ❷ Dirt-repellent, contoured exterior
- ❸ Interior separation with vertical separators possible
- ❹ Small pitch for low-noise, smooth operation
- ❺ One-piece design

● ● ● Price index

Phone +49- (0) 22 03-96 49-800  
Fax +49- (0) 22 03-96 49-222

igus® GmbH  
51147 Cologne

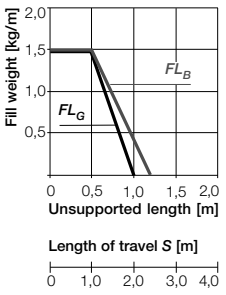

Unsupported length  
 $FL_G$  = with straight upper run  
 $FL_B$  = with permitted sag

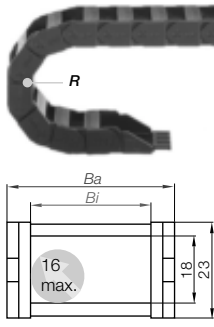
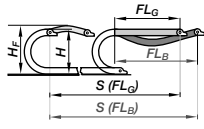

Series 10 classic - non snap-open

Part No.	Bi [mm]	Ba [mm]	R [mm] Bending Radii
10.1.□.0	15	26	028 038 048
10.2.□.0	25	36	075 100* 110*
10.3.□.0	38	49	125* 145* 180*
10.4.□.0	50	61	

Radii for all widths!

\*available upon request!

Supplement Part No. with required radius. Example: 10.2.048.0  
Bending radii listed above can be combined with every chain width!

Part No. structure

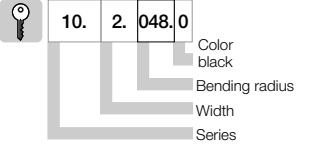

Order example 2,0 m complete E-Chain®  
(indicate chain-lengths or number of links)

2,0 m (66 links) **Series 10.2.048.0**

+ 2 separators 111 assembled each 2<sup>nd</sup> link

+ 1 set mounting brackets + tie-wrap plates 102.12PZ

Pitch = 30,5 mm    Links per m = 33    Chain length =  $\frac{S}{2} + K$

R	028	038	048	075	100*	110*	125*	145*	180*
H	80	100	120	175	225	245	275	315	385
D	70	80	90	120	145	155	170	190	225
K	150	185	215	300	375	410	455	520	630

The required clearance height is  $H_F = H + 20$  mm (with 1,5 kg/m fill weight). Please consult igus® if space is particularly restricted.

Installation Dimensions

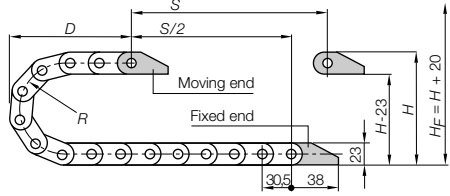

18

E2 mini classic  
Inner height: 18 mm

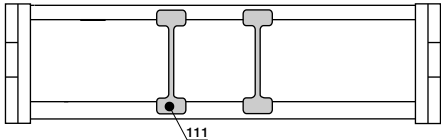

Standard

Vertical separators

unassembled	101
assembled	111

Interior Separation



10...1P(Z)  
Moving end

10...2P(Z)  
Fixed end

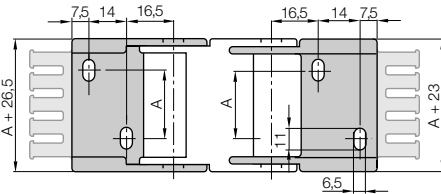

Moving end (with bore)  
10...1P(Z)

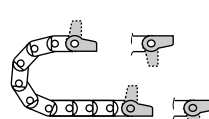

10...2P(Z)  
Fixed end (with pin)

Mounting Brackets



Polymer with or without strain relief tiwrap plates

For E-Chain®	Part No. full set with tiwrap plate	Part No. full set without tiwrap plate	Dimension A [mm]
10.1. ▶	101.12PZ	101.12P	-
10.2. ▶	102.12PZ	102.12P	10
10.3. ▶	103.12PZ	103.12P	23
10.4. ▶	104.12PZ	104.12P	35

Tiwrap plates are possible at the moving end and/or the fixed end!

Part No. structure

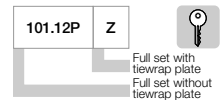

Full set with tiwrap plate  
Full set without tiwrap plate

Full set, for both ends:

101. 12 PZ (+ tiwrap plates)

Single-part order:

101. 1 PZ (+ tiwrap plates)

Mounting bracket with bore

101. 2 PZ (+ tiwrap plates)

Mounting bracket with pin



One-piece or two-piece steel mounting brackets possible

Additional Features

For more features

▶ see link below



www



▶ chapter 9

For new constructions:  
**Series B15 "E2 mini"**  
▶ page 5.62

E2 mini | Series B15 classic

igus® E-ChainSystems®

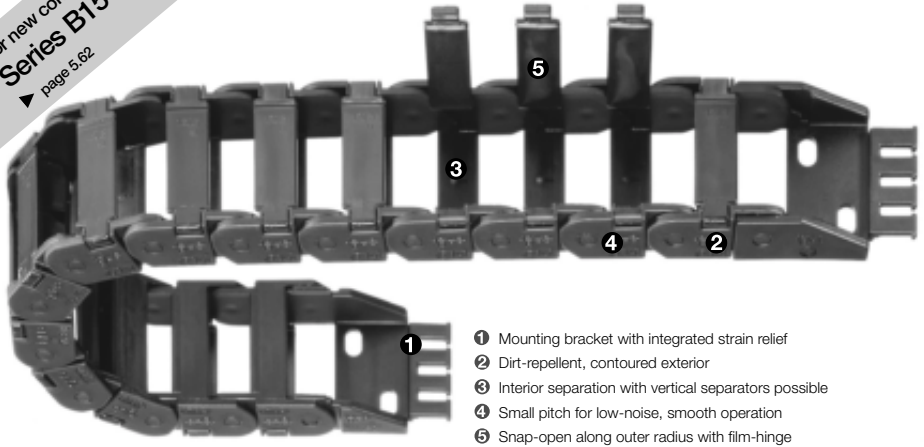

- ❶ Mounting bracket with integrated strain relief
- ❷ Dirt-repellent, contoured exterior
- ❸ Interior separation with vertical separators possible
- ❹ Small pitch for low-noise, smooth operation
- ❺ Snap-open along outer radius with film-hinge

● ● ● Price index

Phone +49- (0) 22 03-96 49-800  
Fax +49- (0) 22 03-96 49-222

igus® GmbH  
51147 Cologne

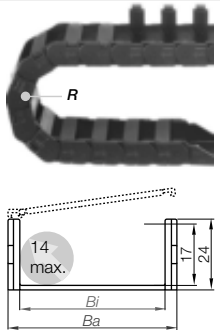
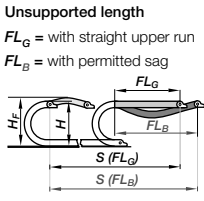
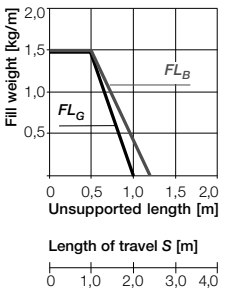

B15 classic - snap-open along inner radius

Part No.	$B_i$ [mm]	$B_a$ [mm]	$R$ [mm] Bending Radii
B15.1. <input type="text"/> .0	15	26	038 048 075
B15.2. <input type="text"/> .0	25	36	110 125 145
B15.3. <input type="text"/> .0	38	49	180
B15.4. <input type="text"/> .0	50	61	

Radii for all widths!

\*available upon request!

Supplement Part No. with required radius. Example: B15.2.048.0  
Bending radii listed above can be combined with every chain width!

Part No. structure

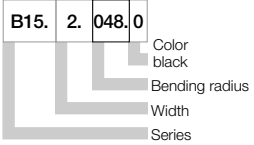

Order example 2,0 m complete E-Chain®  
(indicate chain-lengths or number of links)

2,0 m (66 links) **Series B15.2.048.0**

+ 2 separators **152** assembled each 2<sup>nd</sup> link

+ 1 set mounting brackets + tie-wrap plates **102.12PZ**

Pitch = 30,5 mm   Links per m = 33   Chain length =  $\frac{S}{2} + K$

R	038	048	075	110	125	145	180
H	100	120	175	245	275	315	385
D	80	90	120	155	170	190	225
K	185	215	300	410	455	520	630

The required clearance height is  $H_F = H + 20$  mm (with 1,5 kg/m fill weight). Please consult igus® if space is particularly restricted.

Installation Dimensions

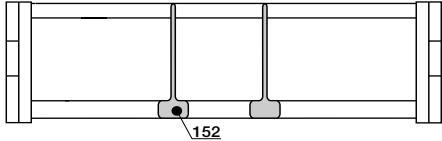
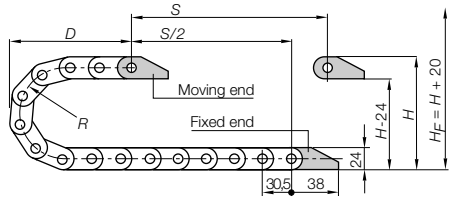

Vertical separators

unassembled	151
assembled	152



Interior Separation



10...1P(Z)  
Moving end

10...2P(Z)  
Fixed end

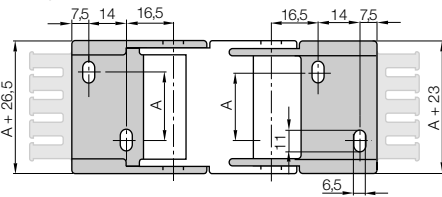

Moving end (with bore)  
10...1P(Z)

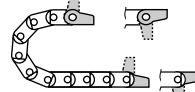

10...2P(Z)  
Fixed end (with pin)

Mounting Brackets

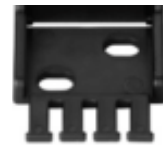

Polymer with or without strain relief tiwrap plates

For E-Chain®	Part No. full set with tiwrap plate	Part No. full set without tiwrap plate	Dimension A [mm]
B15.1. ▶	101.12PZ	101.12P	-
B15.2. ▶	102.12PZ	102.12P	10
B15.3. ▶	103.12PZ	103.12P	23
B15.4. ▶	104.12PZ	104.12P	35

Tiwrap plates are possible at the moving end and/or the fixed end!

Part No. structure

101.12P	Z
---------	---

Full set with tiwrap plate  
Full set without tiwrap plate

Full set, for both ends:

101. 12 PZ (+ tiwrap plates)

Single-part order:

101. 1 PZ (+ tiwrap plates)

Mounting bracket with bore

101. 2 PZ (+ tiwrap plates)

Mounting bracket with pin

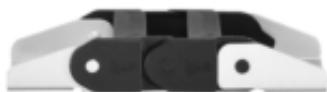

One-piece ore two-piece steel mounting brackets possible

Additional Features

For more features  
▶ see link below



▶ chapter 9



For new constructions:  
Series "E2/000"  
2400/2500 ▶ page 5.94

E2 medium | Series 200·240·250



igus® E-ChainSystems®

Phone +49- (0) 22 03-96 49-800  
Fax +49- (0) 22 03-96 49-222

igus® GmbH  
51147 Cologne

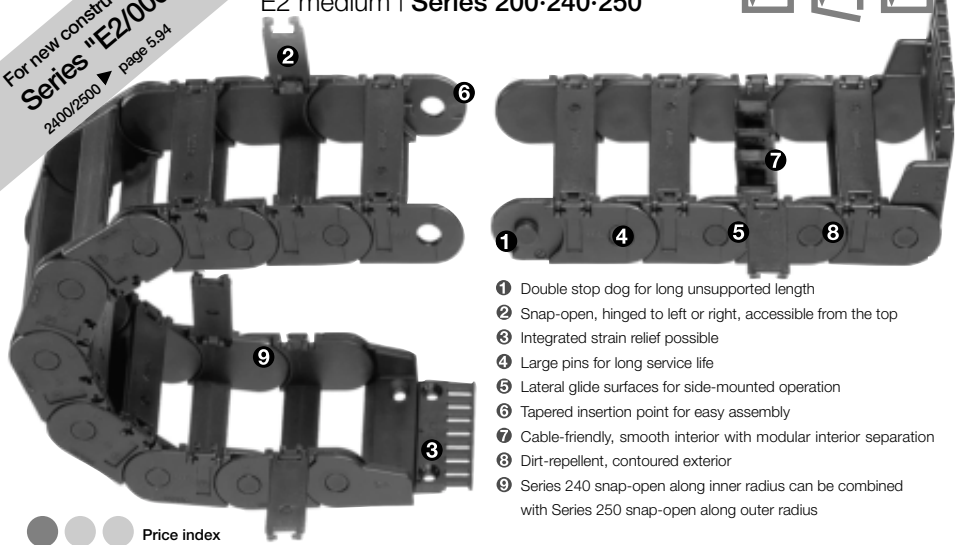

● ● ● Price index

- ❶ Double stop dog for long unsupported length
- ❷ Snap-open, hinged to left or right, accessible from the top
- ❸ Integrated strain relief possible
- ❹ Large pins for long service life
- ❺ Lateral glide surfaces for side-mounted operation
- ❻ Tapered insertion point for easy assembly
- ❼ Cable-friendly, smooth interior with modular interior separation
- ❽ Dirt-repellent, contoured exterior
- ❾ Series 240 snap-open along inner radius can be combined with Series 250 snap-open along outer radius

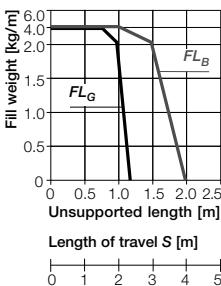

Unsupported length

$FL_G$  = with straight upper run  
 $FL_B$  = with permitted sag

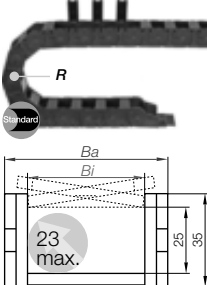
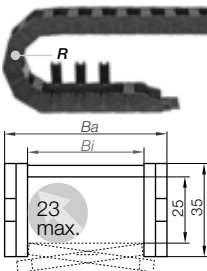
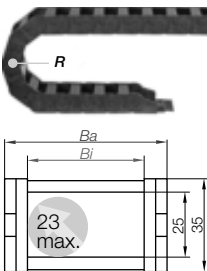
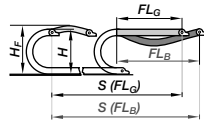

Series 200 - non snap-open

Part No.	Bi [mm]	Ba [mm]	R [mm] Bending Radii
200.02.□.0	25	41	055 075 100
200.03.□.0	38	54	125 150 175
200.05.□.0	57	73	200 225 250
200.07.□.0	77	93	
200.09.□.0	90	106	
200.10.□.0	103	119	
200.12.□.0	125	141	

Radii for all widths!

Supplement Part No. with required radius. Example: 200.10.□.0  
Bending radii listed above can be combined with every chain width!

Series 240 - snap-open along inner radius

Part No.	Bi [mm]	Ba [mm]	R [mm] Bending Radii
240.02.□.0	25	41	055 075 100
240.03.□.0	38	54	125 150 175
240.05.□.0	57	73	200 225 250
240.07.□.0	77	93	
240.09.□.0	90	106	
240.10.□.0	103	119	
240.12.□.0	125	141	

Radii for all widths!

Supplement Part No. with required radius. Example: 240.10.□.0  
Bending radii listed above can be combined with every chain width!

Series 250 - snap-open along outer radius

Part No.	Bi [mm]	Ba [mm]	R [mm] Bending Radii
250.02.□.0	25	41	055 075 100
250.03.□.0	38	54	125 150 175
250.05.□.0	57	73	200 225 250
250.07.□.0	77	93	
250.09.□.0	90	106	
250.10.□.0	103	119	
250.12.□.0	125	141	

Radii for all widths!

Supplement Part No. with required radius. Example: 250.10.□.0  
Bending radii listed above can be combined with every chain width!

Part No. structure

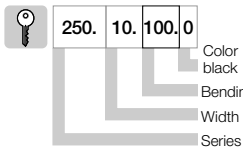

Order example 2,0 m complete E-Chain®  
(Indicate chain-lengths or number of links)

- 2,0 m (44 links) Series 250.10.100.0
- + 2 separators 211 assembled each 2<sup>nd</sup> link
- + 1 set mounting brackets + tiwrap plates 2100.34PZB

Pitch = 46 mm    Links per m = 22    Chain length =  $S/2 + K$

R	055	075	100	125	150	175	200	225	250
H <sup>+</sup>	145	185	235	285	335	385	435	485	535
D	125	150	170	195	220	245	270	295	320
K	276	346	414	496	578	660	742	814	920

The required clearance height is  $H_F = H + 25$  mm (with 1,5 kg/m fill weight). Please consult igus® if space is particularly restricted.

Installation Dimensions

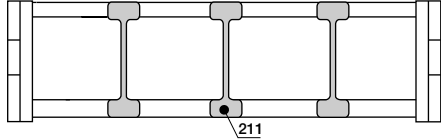
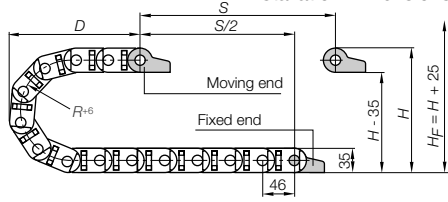

Vertical separators

unassembled	201
assembled	211



Interior Separation

Full program ▶ page 5.88



2...3PZ(B)

Moving end

2...4PZ(B)

Fixed end

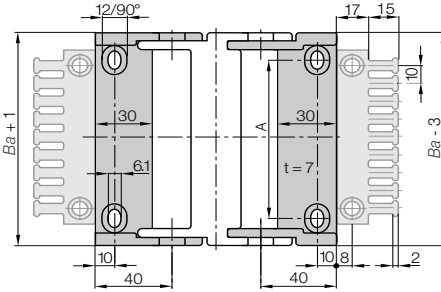

Moving end (with bore)

2...3PZ(B)

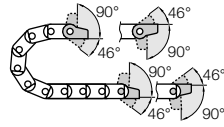

2...4PZ(B)  
Fixed end (with pin)

Mounting Brackets

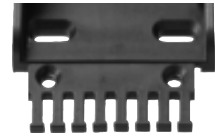

Polymer pivoting, with or without strain relief tiewrap plates

For E-Chain®	Part No. full set with tiewrap plate	Part No. with tiewrap plate + 10 cable tiewraps	Part No. full set without tiewrap plate	Dimension A [mm]
200/240/250.02.	2020.34PZB	2020.34PZBK1	2020.34PZ	12
200/240/250.03.	2030.34PZB	2030.34PZBK1	2030.34PZ	25
200/240/250.05.	2050.34PZB	2050.34PZBK1	2050.34PZ	44
200/240/250.07.	2070.34PZB	2070.34PZBK1	2070.34PZ	64
200/240/250.09.	2090.34PZB	2090.34PZBK1	2090.34PZ	77
200/240/250.10.	2100.34PZB	2100.34PZBK1	2100.34PZ	90
200/240/250.12.	2125.34PZB	2125.34PZBK1	2125.34PZ	112

Tiewrap plates are possible at the moving end and/or the fixed end!

Part No. structure

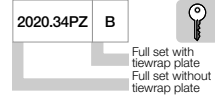

Full set, for both ends:  
[2020.] [34] PZB (+ tiewrap plates)

Single-part order:  
[2020.] [3] PZB (+ tiewrap plates)

Mounting bracket with bore

[2020.] [4] PZB (+ tiewrap plates)

Mounting bracket with pin

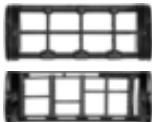

Interior separation with full-width shelves and shelves possible



Polymer mounting bracket, locking



KMA mounting bracket available with C-profile



Steel mounting bracket available

Additional Features

For more features ▶ see link below



E2 medium classic  
Inner height: 25 mm

Phone +49- (0) 22 03-96 49-800  
Fax +49- (0) 22 03-96 49-222



chapter 9

For new constructions:  
**Series "E2/000"**  
2600/2700 ▶ page 5,106

E2 medium | Series 26·27i·27



igus® E-ChainSystems®

Phone +49- (0) 22 03-96 49-800  
Fax +49- (0) 22 03-96 49-222

igus® GmbH  
51147 Cologne

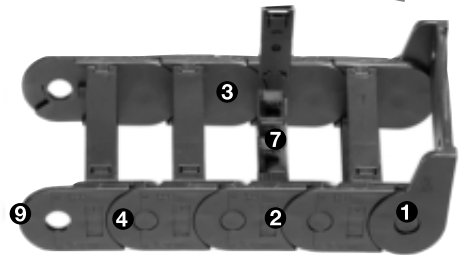

- ① Large pins for long service life
- ② Double stop dog for long unsupported length
- ③ Space-saving ratio of inner-to-outer dimensions
- ④ Lateral glide surfaces for side-mounted operation
- ⑤ Cable-friendly, smooth interior
- ⑥ Series 27i snap-open along inner radius can be combined with Series 27 snap-open along outer radius, accessible from the top
- ⑦ Modular interior separation
- ⑧ Integrated strain relief possible
- ⑨ Side wear pads

● ● ● Price index

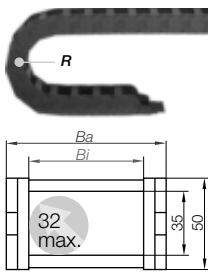
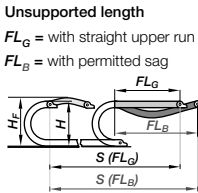
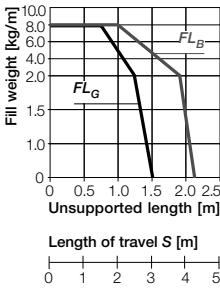

Series 26 - non snap-open

Part No.	$B_i$ [mm]	$B_a$ [mm]	$R$ [mm] Bending Radii
26.05.□.0	50	66	063 075 100
26.07.□.0	75	91	125 150 175
26.10.□.0	100	116	200 250
26.12.□.0	125	141	
26.15.□.0	150	166	
26.17.□.0	175	194	
26.20.□.0	200	219	

Radii for all widths!

Supplement Part No. with required radius. Example: 26.10.□.100.0  
Bending radii listed above can be combined with every chain width!

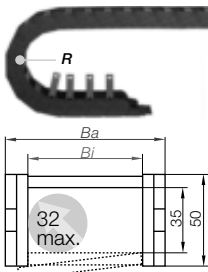

Series 27i - snap-open along inner radius

Part No.	$B_i$ [mm]	$B_a$ [mm]	$R$ [mm] Bending Radii
27i.05.□.0	50	66	063 075 100
27i.07.□.0	75	91	125 150 175
27i.10.□.0	100	116	200 250
27i.12.□.0	125	141	
27i.15.□.0	150	166	
27i.17.□.0	175	194	
27i.20.□.0	200	219	

Radii for all widths!

Supplement Part No. with required radius. Example: 27i.10.□.100.0  
Bending radii listed above can be combined with every chain width!

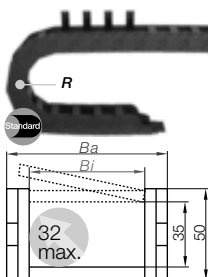

Series 27 - snap-open along outer radius

Part No.	$B_i$ [mm]	$B_a$ [mm]	$R$ [mm] Bending Radii
27.05.□.0	50	66	063 075 100
27.07.□.0	75	91	125 150 175
27.10.□.0	100	116	200 250
27.12.□.0	125	141	
27.15.□.0	150	166	
27.17.□.0	175	194	
27.20.□.0	200	219	

Radii for all widths!

Supplement Part No. with required radius. Example: 27.10.□.100.0  
Bending radii listed above can be combined with every chain width!

Part No. structure

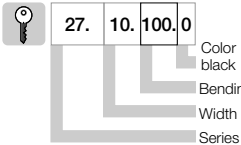

- Order example 3,0 m complete E-Chain®  
(Indicate chain-lengths or number of links)
- 3,0 m (54 links) Series 27.10.100.0
  - + 2 separators 261 assembled each 2<sup>nd</sup> link
  - + 1 set mounting brackets + tiwrap plates 2610.34PZB

Pitch = 56 mm    Links per m = 18    Chain length =  $S/2 + K$

R	063	075	100	125	150	175	200	250
H <sup>+</sup>	180	200	250	300	350	400	450	550
D	140	150	175	200	225	250	275	325
K	335	375	475	550	650	750	825	925

The required clearance height is  $H_F = H + 35$  mm (with 2,0 kg/m fill weight). Please consult igus® if space is particularly restricted.

Installation Dimensions

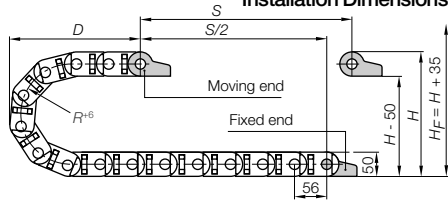

E2 medium classic  
Inner height: 35 mm

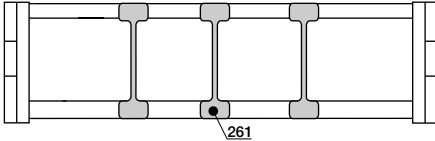

Vertical separators

unassembled	260
assembled	261



Interior Separation

Full program ▶ page 5.100



26...3PZ(B)

Moving end

26...4PZ(B)

Fixed end

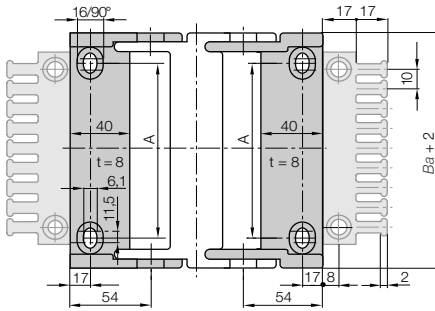

Moving end (with bore)

26...3PZ(B)

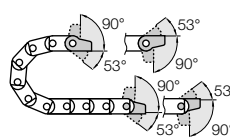

26...4PZ(B)  
Fixed end (with pin)

Mounting Brackets

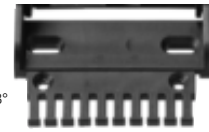

Polymer pivoting, with or without strain relief tiwrap plates

For E-Chain®	Part No.	Part No. with tiwrap plate + 10 cable tiwraps	Part No. full set without tiwrap plate	Dimension A [mm]
26/27/27i.05.	▶ 2605.34PZB	2605.34PZBK1	2605.34PZ	30
26/27/27i.07.	▶ 2607.34PZB	2607.34PZBK1	2607.34PZ	55
26/27/27i.10.	▶ 2610.34PZB	2610.34PZBK1	2610.34PZ	80
26/27/27i.12.	▶ 2612.34PZB	2612.34PZBK1	2612.34PZ	105
26/27/27i.15.	▶ 2615.34PZB	2615.34PZBK1	2615.34PZ	130
26/27/27i.17.	▶ 2617.34PZB	2617.34PZBK1	2617.34PZ	155
26/27/27i.20.	▶ 2620.34PZB	2620.34PZBK1	2620.34PZ	180

Tiwrap plates are possible at the moving end and/or the fixed end!

Part No. structure

2605.34PZ B



Full set, for both ends:

2605.34PZB (+ tiwrap plates)

Single-part order:

2605.3PZB (+ tiwrap plates)

Mounting bracket with bore

2605.4PZB (+ tiwrap plates)

Mounting bracket with pin



Interior separation with full-width shelves and shelves possible



Polymer mounting bracket, locking



KMA mounting bracket available with C-profile

Additional Features

For more features ▶ see link below



Phone +49- (0) 22 03-96 49-800  
Fax +49- (0) 22 03-96 49-222

▶ chapter 10

▶ chapter 9

For new constructions:  
Series "E2/000"  
3400/3500 ▶ page 5,118

igus® E-ChainSystems®

Phone +49- (0) 22 03-96 49-800  
Fax +49- (0) 22 03-96 49-222

igus® GmbH  
51147 Cologne

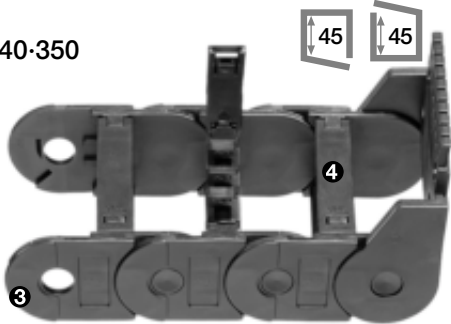

- ① Double stop dog for long unsupported length
- ② Large pins for long service life
- ③ Lateral glide surfaces for side-mounted operation
- ④ Available with extender crossbars for large hoses
- ⑤ Cable-friendly, smooth interior
- ⑥ Integrated strain relief possible
- ⑦ Serie 340 snap-open along inner radius can be combined with Serie 350 snap-open along outer radius, accessible from the top
- ⑧ Dirt-repellent, contoured exterior

● ● ● Price index

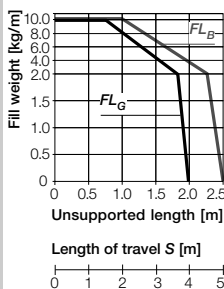

Unsupported length

$FL_G$  = with straight upper run

$FL_B$  = with permitted sag

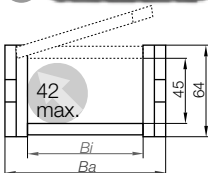
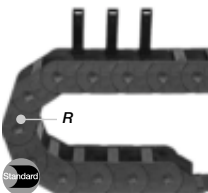
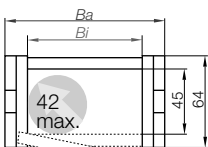
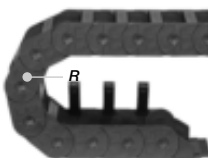
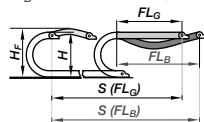

### Series 340 - snap-open along inner radius

Part No.	$Bi$ [mm]	$Ba$ [mm]	$R$ [mm] Bending Radii
340.050.□.0	50	70	075 100 125
340.075.□.0	75	95	150 200 250
340.100.□.0	100	120	300
340.115.□.0	115	135	
340.125.□.0	125	145	Radii for all widths!
340.150.□.0	150	170	
340.175.□.0	175	195	
340.200.□.0	200	220	
340.225.□.0	225	245	
340.250.□.0	250	270	

Supplement Part No. with required radius. Example: 340.050.100.0

Bending radii listed above can be combined with every chain width!

### Series 350 - snap-open along outer radius

Part No.	$Bi$ [mm]	$Ba$ [mm]	$R$ [mm] Bending Radii
350.050.□.0	50	70	075 100 115*
350.075.□.0	75	95	125 150 200
350.100.□.0	100	120	250 300
350.115.□.0	115	135	Radii for all widths!
350.125.□.0	125	145	
350.150.□.0	150	170	
350.175.□.0	175	195	
350.200.□.0	200	220	* not for Series 350.100
350.225.□.0	225	245	
350.250.□.0	250	270	

Supplement Part No. with required radius. Example: 350.150.100.0

Bending radii listed above can be combined with every chain width!

Part No. structure

350.150.100.0

- Color black
- Bending radius
- Width
- Series

Order example 5,0 m complete E-Chain®  
(Indicate chain-lengths or number of links)

5,0 m (75 links) Series 350.150.100.0

+ 2 separators 311 assembled each 2<sup>nd</sup> link

+ 1 set mounting brackets + tiwrap plates 3150.34PZB

igus® extender crossbar  
Extension for Series 340/350 E2 medium -  
For large hoses and enlarged inner heights  
▶ page 12.16

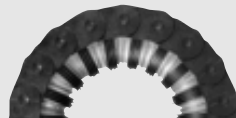

Pitch = 67 mm    Links per m = 15    Chain length =  $S/2 + K$

R	075	100	115*	125	150	200	250	300
H*5	215	265	294	315	365	465	565	665
D	150	200	215	225	250	300	350	400
K	400	500	550	650	725	875	1050	1225

The required clearance height is  $H_F = H + 40$  mm (with 2,5 kg/m fill weight). Please consult igus® if space is particularly restricted.

\* not for Series 350.100

Installation Dimensions

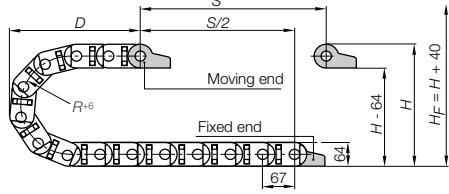

E2 medium classic  
Inner height: 45 mm

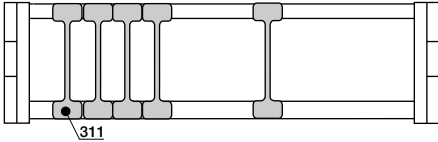

Vertical separators

unassembled	301
assembled	311



Interior Separation

Full program ▶ page 5.112



3...3PZ(B)

Moving end

3...4PZ(B)

Fixed end

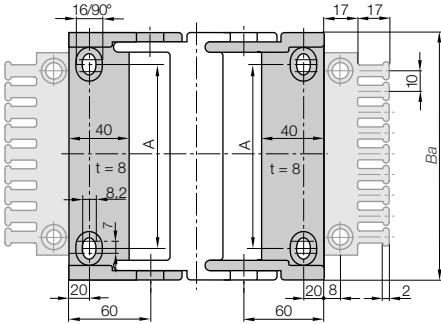

Moving end (with bore)

3...3PZ(B)

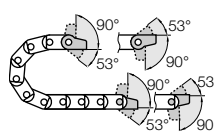

3...4PZ(B)  
Fixed end (with pin)

Mounting Brackets

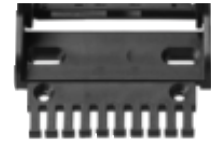

Polymer pivoting, with or without strain relief tiwrap plates

Phone +49- (0) 22 03-96 49-800  
Fax +49- (0) 22 03-96 49-222

For E-Chain®	Part No. full set with tiwrap plate	Part No. with tiwrap plate + 10 cable tiwraps	Part No. full set without tiwrap plate	Dimension A [mm]
340/350.050.	▶ 3050.34PZB	3050.34PZBK1	3050.34PZ	28
340/350.075.	▶ 3075.34PZB	3075.34PZBK1	3075.34PZ	53
340/350.100.	▶ 3100.34PZB	3100.34PZBK1	3100.34PZ	78
340/350.115.	▶ 3115.34PZB	3115.34PZBK1	3115.34PZ	93
340/350.125.	▶ 3125.34PZB	3125.34PZBK1	3125.34PZ	103
340/350.150.	▶ 3150.34PZB	3150.34PZBK1	3150.34PZ	128
340/350.175.	▶ 3175.34PZB	3175.34PZBK1	3175.34PZ	153
340/350.200.	▶ 3200.34PZB	3200.34PZBK1	3200.34PZ	178
340/350.225.	▶ 3225.34PZB	3225.34PZBK1	3225.34PZ	203
340/350.250.	▶ 3250.34PZB	3250.34PZBK1	3250.34PZ	228

Tiwrap plates are possible at the moving end and/or the fixed end!

Part No. structure

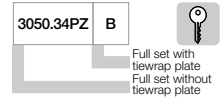

Full set with tiwrap plate  
Full set without tiwrap plate

Full set, for both ends:

3050.34PZB (+ tiwrap plates)

Single-part order:

3050.3PZB (+ tiwrap plates)

Mounting bracket with bore

3050.4PZB (+ tiwrap plates)

Mounting bracket with pin



Interior separation with full-width shelves and shelves



Mounting bracket polymer locking available



KMA mounting bracket available with C-profile

Additional Features

For more features  
▶ see link below



▶ chapter 10



▶ chapter 9

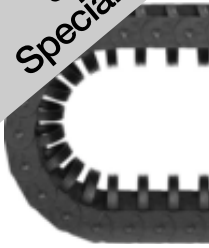

340.150...

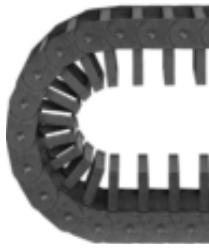

340.175...



350.150...



350.175...

**Extender Crossbar Series 340/350 E2 medium - for larger hoses or increased inner chain heights**

igus® Extender Chains were developed to provide a very smooth hose guidance. This type of extender chain is suitable for hoses with an outside diameter up to 115 mm. Hose guidance for inside radius (Series 350) as well as outside radius (Series 340) can be easily managed. Based on its design, a smooth movement of the chain is only possible with outside radius guidance. If outside radius guidance is used, the extenders of the chain links must be supported separately to avoid touching down on the surface below. We gladly assist you with your selection for a suitable guide troughs and your system's design.

Phone +49- (0) 22 03-96 49-800  
Fax +49- (0) 22 03-96 49-222

igus® GmbH  
51147 Cologne

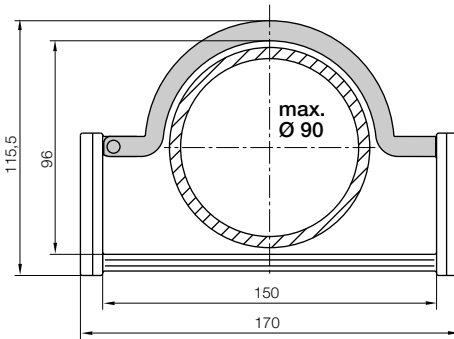

Cross section of a chain link with rounded extender crossbar. Crossbar Part No.: 350.150.D090

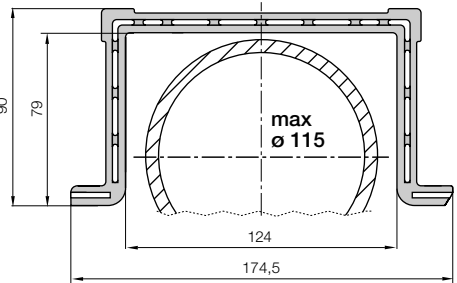

Cross section of a chain link with square extender crossbar. Crossbar Part No.: 350.175.D115\*

For E-Chain® Series	Ø max. hoses [mm]	Fastening method	Form	Bending Radii [mm]
340.150.	90	inner radius	round	150 200 250 300
340.175.	115	inner radius	square	200 250 300
350.150.	90	outer radius	round	075 100 125 150 200 250
350.175.	115	outer radius	square	075 100 125 150 200 250

\*Part No. 350.175.RD115 also available with rounded extender bars. Extenders suitable for Series 3400/3500. Please contact us for further information.

Part No. structure (extender crossbar)

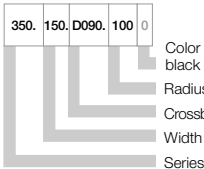

Order example 5,0 m complete E-Chain®  
(indicate chain-lengths or number of links)  
5,0 m (75 links) Series 350.150.D090.100.0  
+ 1 set mounting brackets + tiwrap plates 3150.34PZB







igus® E-Chain® with extender-crossbar - safe guide for big hoses



igus® E2 E-Chains® for various applications and installations



E2 medium classic  
Inner height: 45 mm

Phone +49- (0) 22 03-96 49-800  
Fax +49- (0) 22 03-96 49-222



▶ chapter 10



▶ chapter 9

For new constructions:  
**Series "E2/000"**  
2400/2500 ▶ page 5.94

igus® E-ChainSystems®

Phone +49- (0) 22 03-96 49-800  
Fax +49- (0) 22 03-96 49-222

igus® GmbH  
51147 Cologne

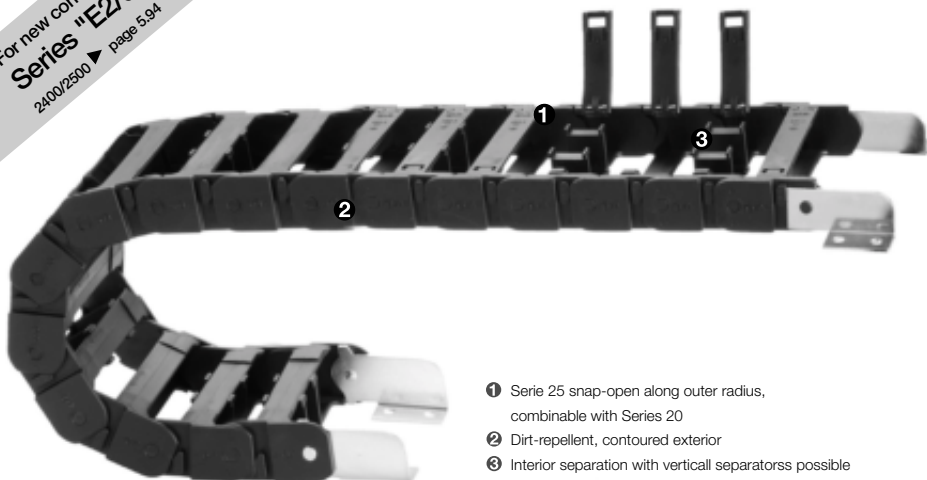

- ❶ Serie 25 snap-open along outer radius, combinable with Series 20
- ❷ Dirt-repellent, contoured exterior
- ❸ Interior separation with vertical separators possible

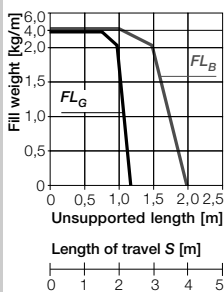

Unsupported length

$FL_G$  = with straight upper run

$FL_B$  = with permitted sag

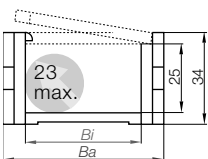
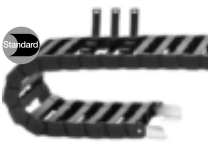
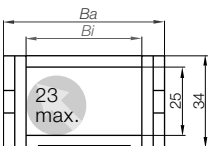
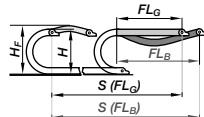

### Series 20 - non snap-open

Part No.	$B_i$ [mm]	$B_a$ [mm]	$R$ [mm] Bending Radii
20.1.□.0	11	27	055 075 100
20.2.□.0	38	53	125 150 200
20.3.□.0	57	72	250
20.4.□.0	77	92	
20.5.□.0	103	118	

Radii for all widths!

Supplement Part No. with required radius. Example: 20.1.□.0  
Bending radii listed above can be combined with every chain width!

### Series 25 - snap-open along outer radius

Part No.	$B_i$ [mm]	$B_a$ [mm]	$R$ [mm] Bending Radii
25.1.□.0	11	27	055 075 100
25.2.□.0	38	53	125 150 200
25.3.□.0	57	72	250
25.4.□.0	77	92	
25.5.□.0	103	118	

Radii for all widths!

Supplement Part No. with required radius. Example: 25.1.□.0  
Bending radii listed above can be combined with every chain width!

Part No. structure

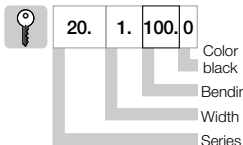

**Order example 4,0 m complete E-Chain®**  
(indicate chain-lengths or number of links)

4,0 m (88 links) **Series 20.1.100.0**

+ 2 separators **211** assembled each 2<sup>nd</sup> link

+ 1 set mounting brackets **200.12**

Pitch = 46 mm    Links per m = 22    Chain length =  $S/2 + K$

<b>R</b>	055	075	100	125	150	200	250
<b>H*5</b>	145	185	235	285	335	435	535
<b>D</b>	125	150	170	195	220	270	320
<b>K</b>	276	346	414	476	598	736	920

The required clearance height is  $H_F = H + 25$  mm (with 1,5 kg/m fill weight). Please consult igus® if space is particularly restricted.

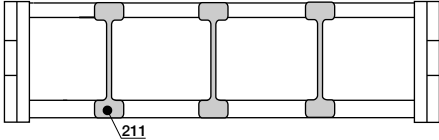
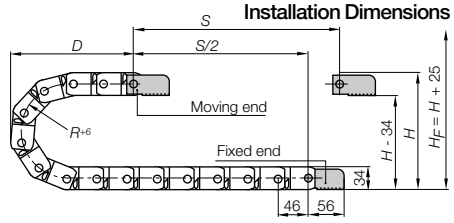

**Interior Separation**

Standard

Vertical separators

unassembled	201
assembled	211

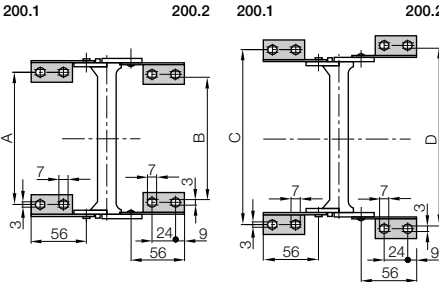

**Mounting Brackets**

Moving end (with bore) 200.1

Fixed end (with pin) 200.2

Steel, two-piece, one part for all chain widths

For E-Chain®	Part No.	Dim. A [mm]	Dim. B [mm]	Dim. C [mm]	Dim. D [mm]
20.1.	200.12	-	-	43	28
20/25.2.	200.12	27	22	71	79
20/25.3.	200.12	45	41	89	97
20/25.4.	200.12	66	61	109	117
20/25.5.	200.12	92	87	135	143

Full set, for both ends: [200.12](#)

Single-part order: [200.1](#)

Mounting bracket with bore: [200.2](#)

Mounting bracket with pin

Interior separation with full-width shelves and shelves

One-piece, steel mounting bracket available

**Additional Features**

For more features  
▶ see link below

25

E2 medium classic  
Inner height: 25 mm

Phone +49- (0) 22 03-96 49-800  
Fax +49- (0) 22 03-96 49-222





For new constructions:  
**Series "E2/000"**  
3400/3500 ▶ page 5,118

igus® E-ChainSystems®

Phone +49- (0) 22 03-96 49-800  
Fax +49- (0) 22 03-96 49-222

igus® GmbH  
51147 Cologne

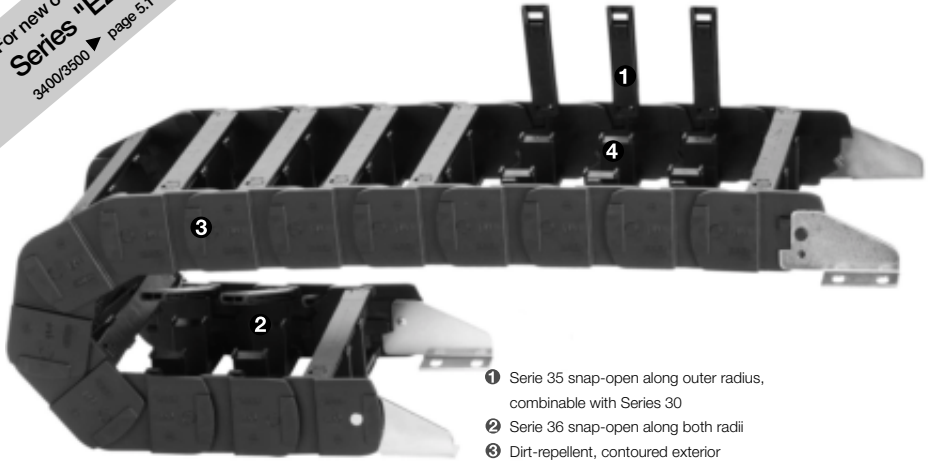

- ❶ Serie 35 snap-open along outer radius, combinable with Series 30
- ❷ Serie 36 snap-open along both radii
- ❸ Dirt-repellent, contoured exterior
- ❹ Interior separation with vertical separatorss possible

● ● ● Price index

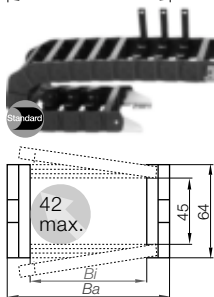
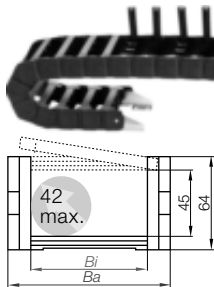
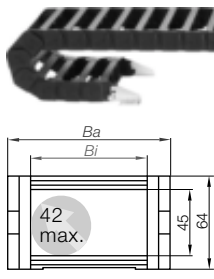
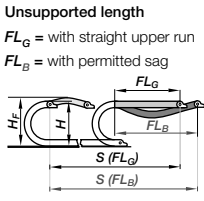
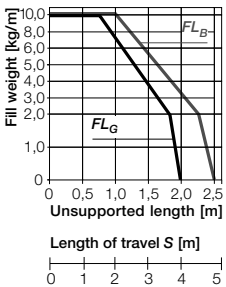

**Series 30 - non snap-open**

Part No.	$B_i$ [mm]	$B_a$ [mm]	$R$ [mm] Bending Radii
30.1.□.0	75	93	075 100 125
30.2.□.0	115	133	150 200 250
30.3.□.0	175	195	300

Radii for all widths!

Supplement Part No. with required radius. Example: 30.1.□.100.0  
Bending radii listed above can be combined with every chain width!

**Series 35 - snap-open along outer radius**

Part No.	$B_i$ [mm]	$B_a$ [mm]	$R$ [mm] Bending Radii
35.1.□.0	75	93	075 100 125
35.2.□.0	115	133	150 200 250
35.3.□.0	175	195	300

Radii for all widths!

Supplement Part No. with required radius. Example: 35.1.□.100.0  
Bending radii listed above can be combined with every chain width!

**Series 36 - snap-open along both radii**

Part No.	$B_i$ [mm]	$B_a$ [mm]	$R$ [mm] Bending Radii
36.1.□.0	75	93	075 100 125
36.2.□.0	115	133	150 200 250
36.3.□.0	175	195	300

Radii for all widths!

Supplement Part No. with required radius. Example: 36.1.□.100.0  
Bending radii listed above can be combined with every chain width!

Part No. structure

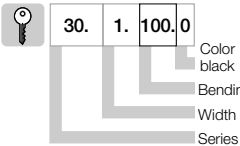

- Order example 2,0 m complete E-Chain®**  
(Indicate chain-lengths or number of links)
- 2,0 m (30 links) **Series 30.1.100.0**
  - + 2 separators **311** assembled each 2<sup>nd</sup> link
  - + 1 set mounting brackets **300.12**

Pitch = 67 mm    Links per m = 15    Chain length =  $S/2 + K$

<b>R</b>	075	100	125	150	200	250	300
<b>H*5</b>	215	265	315	365	465	565	665
<b>D</b>	150	200	225	250	300	350	400
<b>K</b>	400	500	650	725	875	1050	1225

The required clearance height is  $H_F = H + 40$  mm (with 2,5 kg/m fill weight). Please consult igus® if space is particularly restricted.

Installation Dimensions

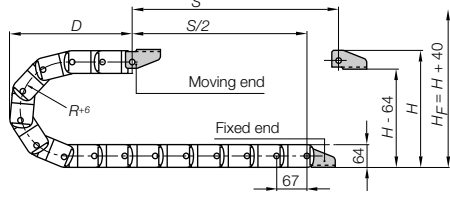

45

E2 medium classic  
Inner height: 45 mm

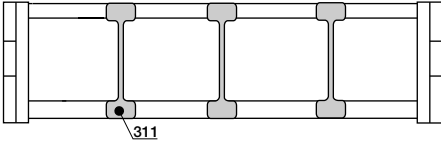

Standard

Vertical separators

unassembled	301
assembled	311



Interior Separation

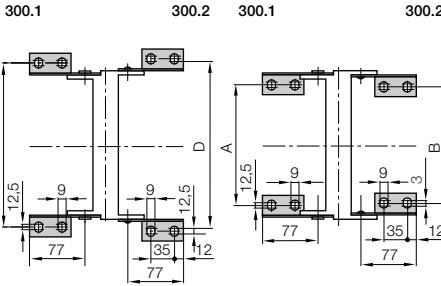

Moving end (with bore)  
300.1

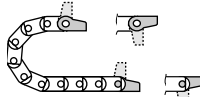

Mounting Brackets



300.2  
Fixed end (with pin)

Steel, two-piece,  
one part for all chain widths

Full set,  
for both ends:

[300.12](#)

Single-part order:

[300.1](#)

Mounting bracket with bore

[300.2](#)

Mounting bracket with pin

For E-Chain®	Part No.	Dim. C [mm]	Dim. D [mm]	Dim. A [mm]	Dim. B [mm]
30/35/36.1	300.12	111	122	60	54
30/35/36.2	300.12	151	162	100	94
30/35/36.3	300.12	212	224	161	155



Interior separation with full-width shelves and shelves



One-piece, steel mounting bracket available

Additional Features

For more features  
▶ see link below



Phone +49- (0) 22 03-96 49-800  
Fax +49- (0) 22 03-96 49-222



E2 E-Tubes | Series R58 classic

For new constructions:  
**Series "E2 Tubes"**  
 R58 ▶ page 6.34

igus® E-ChainSystems®

Phone +49- (0) 22 03-96 49-800  
 Fax +49- (0) 22 03-96 49-222

igus® GmbH  
 51147 Cologne

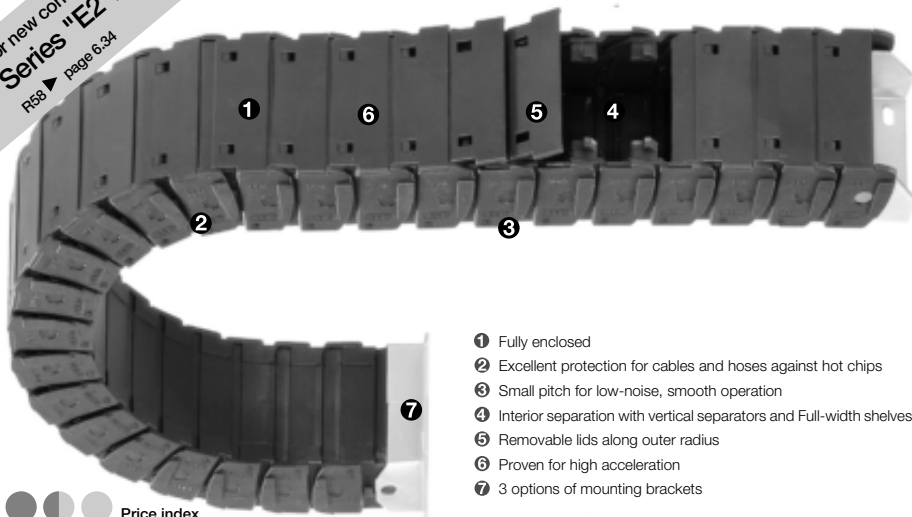

- ① Fully enclosed
- ② Excellent protection for cables and hoses against hot chips
- ③ Small pitch for low-noise, smooth operation
- ④ Interior separation with vertical separators and Full-width shelves
- ⑤ Removable lids along outer radius
- ⑥ Proven for high acceleration
- ⑦ 3 options of mounting brackets

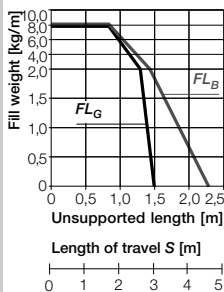

Unsupported length

$FL_G$  = with straight upper run

$FL_B$  = with permitted sag

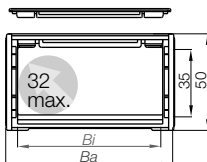
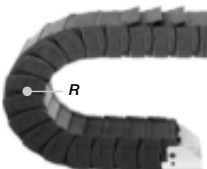
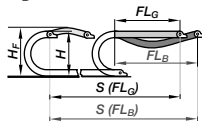

R58 classic - snap-open along outer radius

Part No.	$B1$ [mm]	$B2$ [mm]	$R$ [mm] Bending Radii
58.05. <input type="text"/> .0	50	66	075 100 125
58.1. <input type="text"/> .0	75	92	150 200 250

Radii for all widths!

Supplement Part No. with required radius. Example: 58.1.100.0  
 Bending radii listed above can be combined with every tube width!



Series R58 classic in the chipping area of machine tools

Part No. structure

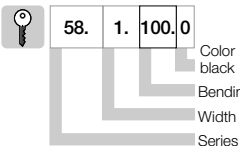

Order example 3,0 m complete E-Tube  
 (indicate tube-lengths or number of links)

3,0 m (90 links) **Series 58.1.100.0**

+ 2 separators **581** assembled each 2<sup>nd</sup> link

+ 1 set mounting brackets **581.12**

Pitch = 33,3 mm    Links per m = 30    Chain length =  $\frac{S}{2} + K$

<b>R</b>	075	100	125	150	200	250
<b>H</b>	200	250	300	350	450	550
<b>D</b>	150	175	200	225	275	325
<b>K</b>	375	475	550	650	825	925

The required clearance height is  $H_F = H + 35$  mm (with 0,5 kg/m fill weight). Please consult igus® if space is particularly restricted.

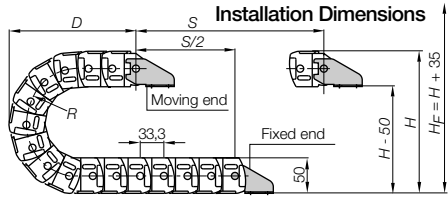

35

E2 Tubes classic  
Inner height: 35 mm

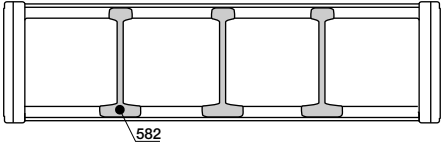

Standard

**Vertical separators**

unassembled	581
assembled	582

**Interior Separation**

Full program ▶ page 6.31

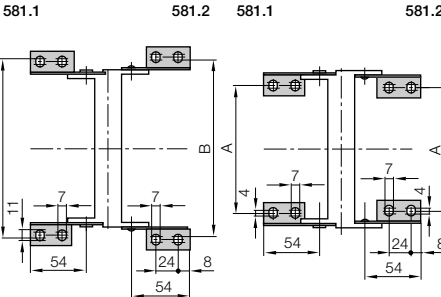

**Moving end (with bore)**

581.1

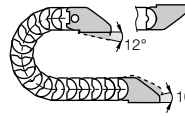

581.2

Fixed end (with pin)

**Mounting Brackets**



Steel, two-piece, pivoting - attachment with socket head cap bolt M6 DIN 912-8.8

For E-Chain®	Part No. full set	Dimension A [mm]	Dimension B [mm]
58.05. ▶	581.12	36,5	84
58.1. ▶	581.12	62	108

The following parts are required for attachment of the mounting brackets:

- Socket head cap bolt M6\* DIN 912-8.8                    4 pieces/set
- Washer 6,3 DIN 125-ST                                    8 pieces/set
- Hexagon nut M6 DIN 934-8                                4 pieces/set

\* The length of the socket head cap bolt is dependent on the thickness of the attachment base.



Full set, for both ends:

581. 12

Single-part order:

581. 1

Mounting bracket with bore

581. 2

Mounting bracket with pin



Interior separation with full-width shelves and shelves



One-piece, steel mounting bracket, pivoting



Steel mounting bracket, flange, pivoting

**Additional Features**

For more features

▶ see link below



Phone +49- (0) 22 03-96 49-800  
Fax +49- (0) 22 03-96 49-222



chapter 9



E2 E-Tubes | Series R68 classic

For new constructions:  
**Series "E2 Tubes"**  
 R68 ▶ page 6-42

igus® E-ChainSystems®

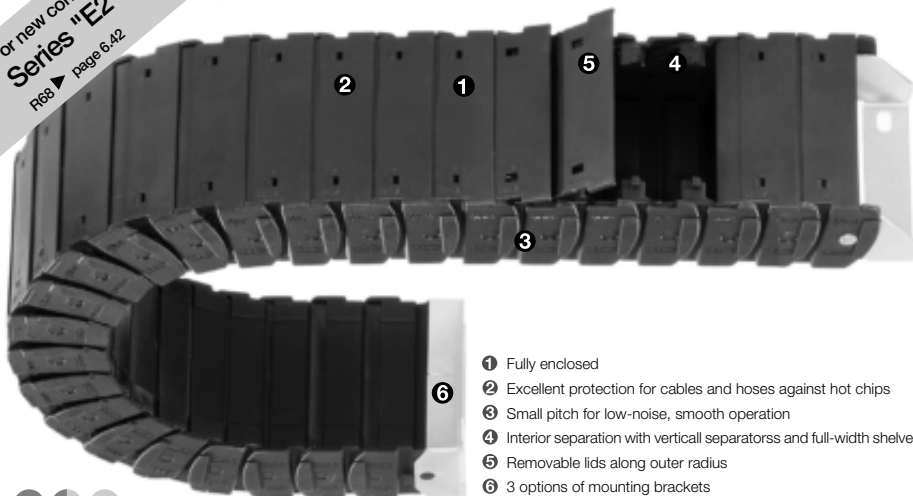

- 1 Fully enclosed
- 2 Excellent protection for cables and hoses against hot chips
- 3 Small pitch for low-noise, smooth operation
- 4 Interior separation with vertical separators and full-width shelves
- 5 Removable lids along outer radius
- 6 3 options of mounting brackets



Phone +49- (0) 22 03-96 49-800  
 Fax +49- (0) 22 03-96 49-222

igus® GmbH  
 51147 Cologne

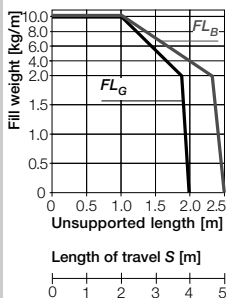

Length of travel S [m]

Unsupported length  
 FL<sub>G</sub> = with straight upper run  
 FL<sub>B</sub> = with permitted sag

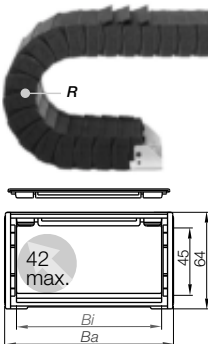
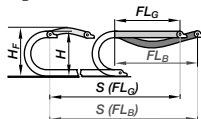

R68 classic - snap-open along outer radius

Part No.	B1 [mm]	Ba [mm]	R [mm] Bending Radii
68.1. <input type="checkbox"/> .0	75	93	100 125 150
68.2. <input type="checkbox"/> .0	115	133	200 225 250
68.3. <input type="checkbox"/> .0	175	196	300
Radii for all widths!			

Supplement Part No. with required radius. Example: 68.1. .0  
 Bending radii listed above can be combined with every tube width!

Part No. structure

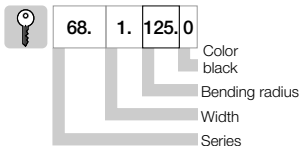

Order example 3,0 m complete E-Tube  
 (indicate tube-lengths or number of links)

3,0 m (84 links) **Series 68.1.125.0**

+ 2 separators 311 assembled each 2<sup>nd</sup> link

+ 1 set mounting brackets 681.12



Series R68 classic - fully enclosed E-Tube

Pitch = 36 mm    Links per m = 28    Chain length =  $S/2 + K$

R	100	125	150	200	225	250	300
H	265	315	365	465	515	565	665
D	200	225	250	300	325	350	400
K	500	650	725	875	975	1050	1225

The required clearance height is  $H_F = H + 40$  mm (with 2,5 kg/m fill weight). Please consult igus® if space is particularly restricted.

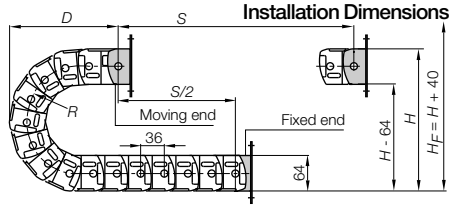

45

E2 Tubes classic  
Inner height: 45 mm

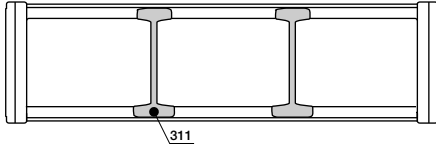

Standard

Vertical Separator

unassembled	301
assembled	311



Interior Separation

Full program ▶ page 6.37

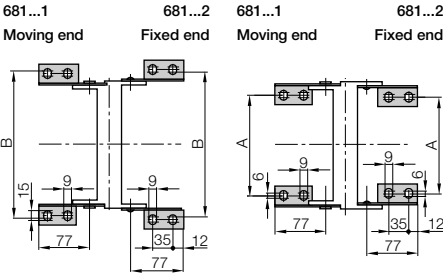

Moving end (with bore)  
681.1

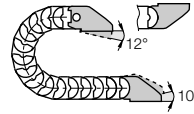

Mounting Brackets



681.2  
Fixed end (with pin)

Steel, two-piece, pivoting - attachment with socket head cap bolt M6 DIN 912-8.8

For E-Chain®	Part No.	Dimension A [mm]	Dimension B [mm]
681.1	681.12	60	112
681.2	681.12	100	152
681.3	681.12	160	212

The following parts are required for attachment of the mounting brackets:

- Socket head cap bolt M6\* DIN 912-8.8    4 pieces/set
- Washer 6,3 DIN 125-ST    8 pieces/set
- Hexagon nut M6 DIN 934-8    4 pieces/set

\* The length of the socket head cap bolt is dependent on the thickness of the attachment base.



Full set, for both ends:

681. 12

Single-part order:

681. 1

Mounting bracket with bore

681. 2

Mounting bracket with pin



Interior separation with full-width shelves and shelves



One-piece, steel mounting bracket, pivoting



Steel mounting bracket, flange, pivoting

Additional Features

For more features

▶ see link below



chapter 9

For new constructions:  
**Series "E4 light"**  
140A0/141A0/R188A0 ▶ page 7.162

igus® E-ChainSystems®

Phone +49- (0) 22 03-96 49-800  
Fax +49- (0) 22 03-96 49-222

igus® GmbH  
51147 Cologne

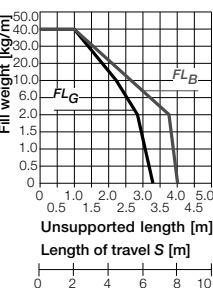

Unsupported length

$FL_G$  = with straight upper run

$FL_B$  = with permitted sag

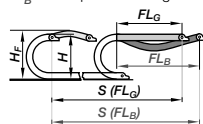

### Series 140 crossbars every link



### Series 141 crossbars every 2<sup>nd</sup> link

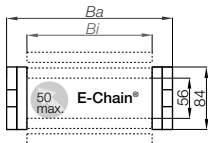
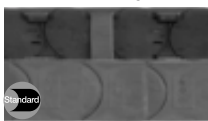

### Series R188 fully enclosed E-Tube

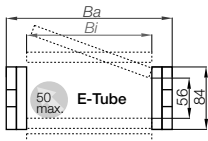

Price index



Series 140



Series 141



Series R188

- ❶ Crossbars are removable along both radii
- ❷ E-Tube: hinged snap-open removable lids
- ❸ Closed and open styles can be combined
- ❹ Lateral glide surfaces for side-mounted operation
- ❺ Large, rounded crossbars for long cable life
- ❻ Removable lids along inner radius
- ❼ Mounting brackets available both locking and pivoting
- ❽ KMA mounting brackets with attachment points on all sides
- ❾ Integrated strain relief possible

Part No.	$B_i$ [mm]	$B_a$ [mm]	$R_i$ [mm] Bending Radii	
140/141.05. . . . .	. . . . .0	50	76	135** 150 175
140/141.06. . . . .	. . . . .0	65	91	200 250 300
140/141/188.07. . . . .	. . . . .0*	75	101	400 500
140/141/188.10. . . . .	. . . . .0	100	126	
140/141.11. . . . .	. . . . .0	112	139	
140/141/188.12. . . . .	. . . . .0	125	151	
140/141.13. . . . .	. . . . .0	137	164	
140/141/188.15. . . . .	. . . . .0	150	176	
140/141.16. . . . .	. . . . .0	162	189	
140/141.17. . . . .	. . . . .0	175	201	
140/141.18. . . . .	. . . . .0	187	214	
140/141/188.20. . . . .	. . . . .0	200	226	
140/141.21. . . . .	. . . . .0	212	239	
140/141.22. . . . .	. . . . .0	225	251	
140/141.23. . . . .	. . . . .0	237	264	
140/141/188.25. . . . .	. . . . .0	250	276	
140/141.26. . . . .	. . . . .0	262	289	
140/141.27. . . . .	. . . . .0	275	301	
140/141.28. . . . .	. . . . .0	287	314	
140/141/188.30. . . . .	. . . . .0	300	326	
140/141.31. . . . .	. . . . .0	312	339	
140/141.32. . . . .	. . . . .0	325	351	
140/141.33. . . . .	. . . . .0	337	364	
140/141/188.35. . . . .	. . . . .0	350	376	
140/141.36. . . . .	. . . . .0	362	389	
140/141.37. . . . .	. . . . .0	375	401	
140/141.38. . . . .	. . . . .0	387	414	
140/141/188.40. . . . .	. . . . .0	400	426	
140/141.41. . . . .	. . . . .0	412	439	
140/141.42. . . . .	. . . . .0	425	451	
140/141.43. . . . .	. . . . .0	437	464	
140/141.45. . . . .	. . . . .0	450	476	
140/141/188.46. . . . .	. . . . .0	462	489	
140/141.47. . . . .	. . . . .0	475	501	
140/141.48. . . . .	. . . . .0	487	514	
140/141.50. . . . .	. . . . .0	500	526	
140/141.51. . . . .	. . . . .0	512	539	
140/141.52. . . . .	. . . . .0	525	551	
140/141.53. . . . .	. . . . .0	537	564	
140/141.55. . . . .	. . . . .0	550	576	
140/141.60. . . . .	. . . . .0	600	626	

\* Removable lid only,  
no hinged option  
\*\* Not available  
for R188

Supplement Part No. with required radius. Example: 140.30.300.0  
Bending radii listed above can be combined with every tube width!

Part No. structure

140. 30. 300. 0

Color

black

Bending radius

Width

Series



Order example 5,0 m complete E-Chain®

(indicate chain-lengths or number of links)

5,0 m (55 links) **Series 140.30.300.0**

+ 2 separators **411** assembled each 2<sup>nd</sup> link

+ 1 set mounting brackets with C-profile **1410.30.12.B.C**

Pitch = 91 mm    Links per m = 11    Chain length =  $S/2 + K$

R	135	150	175	200	250	300	400	500
H <sup>+25</sup>	360	385	435	485	585	685	885	1085
D	270	285	310	335	385	435	535	635
K	650	750	825	900	1050	1225	1450	1775

The required clearance height is  $H_F = H + 50$  mm (with 2,0 kg/m fill weight). Please consult igus® if space is particularly restricted.

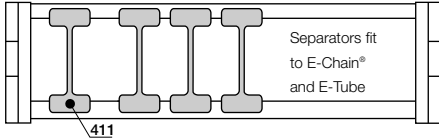
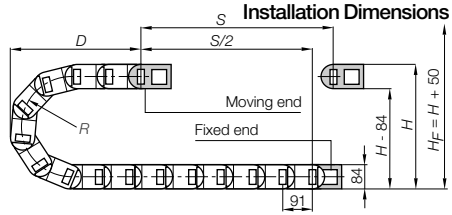

Vertical Separator

unassembled	401
assembled	411



Interior Separation

Full program ▶ page 7.134

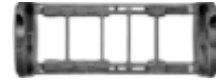

1410/1890...1.B

Moving end

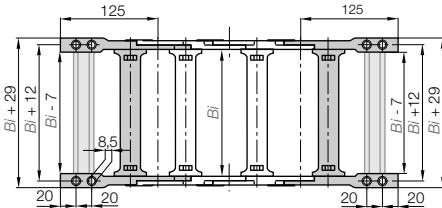

1410/1890...2.B

Fixed end

Moving end (with bore)

1410/1890...1.B

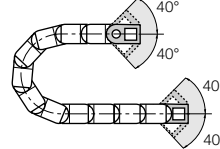

1410/1890...2.B

Fixed end (with pin)

Mounting Brackets



KMA pivoting - attachment with socket head cap bolt M8 DIN 912-8.8

For E-Chain®	Part No. full set	Bi
width-index	optional with C-profile	[mm]
.05.	▶ 1410 .....05.12.B. C	50
.06.	▶ 1410 .....06.12.B. C	65
.07.	▶ 1410/1890.07.12.B. C	75
.10.	▶ 1410/1890.10.12.B. C	100
.11.	▶ 1410 .....11.12.B. C	112
.12.	▶ 1410/1890.12.12.B. C	125
.13.	▶ 1410 .....13.12.B. C	137
.15.	▶ 1410/1890.15.12.B. C	150
.16.	▶ 1410 .....16.12.B. C	162
.17.	▶ 1410 .....17.12.B. C	175
.18.	▶ 1410 .....18.12.B. C	187
.20.	▶ 1410/1890.20.12.B. C	200
.21.	▶ 1410 .....21.12.B. C	212
.22.	▶ 1410 .....22.12.B. C	225
.23.	▶ 1410 .....23.12.B. C	237
.25.	▶ 1410/1890.25.12.B. C	250
.26.	▶ 1410 .....26.12.B. C	262
.27.	▶ 1410 .....27.12.B. C	275
.28.	▶ 1410 .....28.12.B. C	287
.30.	▶ 1410/1890.30.12.B. C	300
.31.	▶ 1410 .....31.12.B. C	312

For E-Chain®	Part No. full set	Bi
width-index	optional with C-profile	[mm]
.32.	▶ 1410 .....32.12.B. C	325
.33.	▶ 1410 .....33.12.B. C	337
.35.	▶ 1410/1890.35.12.B. C	350
.36.	▶ 1410 .....36.12.B. C	362
.37.	▶ 1410 .....37.12.B. C	375
.38.	▶ 1410 .....38.12.B. C	387
.40.	▶ 1410/1890.40.12.B. C	400
.41.	▶ 1410 .....41.12.B. C	412
.42.	▶ 1410 .....42.12.B. C	425
.43.	▶ 1410 .....43.12.B. C	437
.45.	▶ 1410 .....45.12.B. C	450
.46.	▶ 1410/1890.46.12.B. C	462
.47.	▶ 1410 .....47.12.B. C	475
.48.	▶ 1410 .....48.12.B. C	487
.50.	▶ 1410 .....50.12.B. C	500
.51.	▶ 1410 .....51.12.B. C	512
.52.	▶ 1410 .....52.12.B. C	525
.53.	▶ 1410 .....53.12.B. C	537
.55.	▶ 1410 .....55.12.B. C	550
.60.	▶ 1410 .....60.12.B. C	600

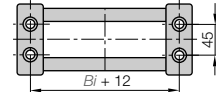

Part No. structure

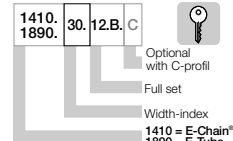

Full set, for both ends:

1410.30. 12.B.

Single-part order:

1410.30. 1.B.

Mounting bracket with bore

1410.30. 2.B.

Mounting bracket with pin



Various interior separation possible



Extension links for very large E-Chains®



Hinged crossbars for side-mounted E-Chains®



KMA mounting brackets, locking

Additional Features

For more features ▶ see link below



E4/light  
Inner height: 56 mm

Phone +49- (0) 22 03-96 49-800  
Fax +49- (0) 22 03-96 49-222



▶ chapter 9

For new constructions:  
**Series "E4 light"**  
142/0/143/0 ▶ page 7.172

E4/light | Series 142-143

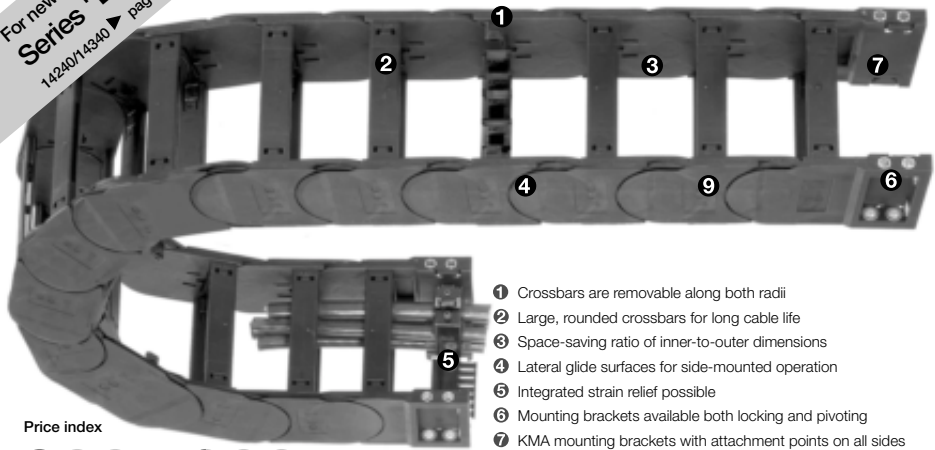

- 1 Crossbars are removable along both radii
- 2 Large, rounded crossbars for long cable life
- 3 Space-saving ratio of inner-to-outer dimensions
- 4 Lateral glide surfaces for side-mounted operation
- 5 Integrated strain relief possible
- 6 Mounting brackets available both locking and pivoting
- 7 KMA mounting brackets with attachment points on all sides

Price index

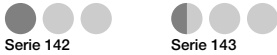

Phone +49- (0) 22 03-96 49-800  
Fax +49- (0) 22 03-96 49-222

igus® GmbH  
51147 Cologne

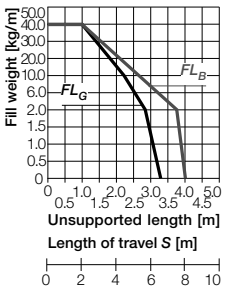

Unsupported length  
FL<sub>G</sub> = with straight upper run  
FL<sub>B</sub> = with permitted sag

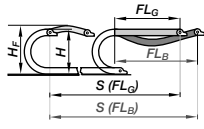

Series 142  
crossbars every link



Series 143  
crossbars every 2<sup>nd</sup> link

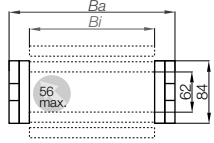
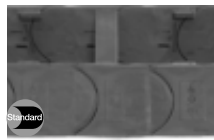

Part No.	Bi [mm]	Ba [mm]	R [mm] Bending Radii
142/143.05.	50	76	135 150 175
142/143.06.	68	94	200 250 300
142/143.07.	75	101	400 500
142/143.087.	87	114	
142/143.10.	100	126	
142/143.11.	108	134	
142/143.112.	112	139	
142/143.12.	125	151	
142/143.137.	137	164	
142/143.15.	150	176	
142/143.162.	162	189	
142/143.17.	168	194	
142/143.18.	175	201	
142/143.187.	187	214	
142/143.20.	200	226	
142/143.212.	212	239	
142/143.23.	225	251	
142/143.237.	237	264	
142/143.25.	250	276	
142/143.262.	262	289	
142/143.28.	275	301	
142/143.29.	287	314	
142/143.30.	300	326	
142/143.312.	312	339	
142/143.325.	325	351	
142/143.337.	337	364	
142/143.350.	350	376	
142/143.362.	362	389	
142/143.375.	375	401	
142/143.387.	387	414	
142/143.400.	400	426	

Radi for all widths!

Part No. structure

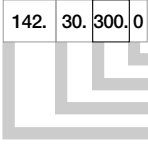

- Color black
- Bending radius
- Width
- Series

**Order example 6,0 m complete E-Chain®**  
(Indicate chain-lengths or number of links)  
6,0 m (66 links) **Series 142.30.300.0**  
+ 2 separators **417** assembled each 2<sup>nd</sup> link  
+ 1 set mounting brackets with C-profile **1430.30.12.B.C**

Supplement Part No. with required radius. Example: 143.30.300.0  
Bending radii listed above can be combined with every chain width!

Pitch = 91 mm    Links per m = 11    Chain length =  $S/2 + K$

<b>R</b>	135	150	175	200	250	300	400	500
<b>H<sup>25</sup></b>	360	385	435	485	585	685	885	1085
<b>D</b>	270	285	310	335	385	435	535	635
<b>K</b>	650	750	825	900	1050	1225	1450	1775

The required clearance height is  $H_F = H + 50$  mm (with 2,0 kg/m fill weight). Please consult igus® if space is particularly restricted.

Installation Dimensions

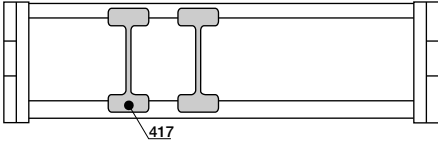
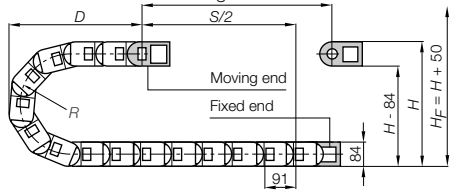

Vertical Separator

unassembled	407
assembled	417



Interior Separation

Full program ▶ page 7.144



1430...1.B

Moving end

1430...2.B

Fixed end

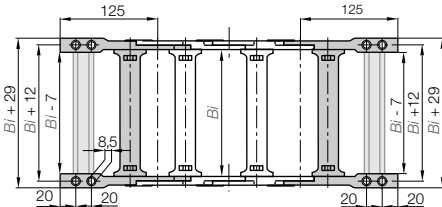

Moving end (with bore)

1430...1.B

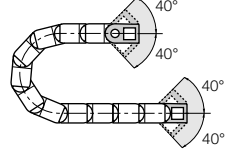

1430...2.B  
Fixed end (with pin)

Mounting Brackets



KMA pivoting - attachment with socket head cap bolt M8 DIN 912-8.8

For E-Chain® Part No. full set		Bi
width-index	optional with C-profile	[mm]
.05.	▶ 1430.05 .12.B. [C]	50
.06.	▶ 1430.06 .12.B. [C]	68
.07.	▶ 1430.07 .12.B. [C]	75
.087.	▶ 1430.087.12.B. [C]	87
.10.	▶ 1430.10 .12.B. [C]	100
.11.	▶ 1430.11 .12.B. [C]	108
.112.	▶ 1430.112.12.B. [C]	112
.12.	▶ 1430.12 .12.B. [C]	125
.137.	▶ 1430.137.12.B. [C]	137
.15.	▶ 1430.15 .12.B. [C]	150
.162.	▶ 1430.162.12.B. [C]	162
.17.	▶ 1430.17 .12.B. [C]	168
.18.	▶ 1430.18 .12.B. [C]	175
.187.	▶ 1430.187.12.B. [C]	187
.20.	▶ 1430.20 .12.B. [C]	200
.212.	▶ 1430.212.12.B. [C]	212

For E-Chain® Part No. full set		Bi
width-index	optional with C-profile	[mm]
.23.	▶ 1430.23 .12.B. [C]	225
.237.	▶ 1430.237.12.B. [C]	237
.25.	▶ 1430.25 .12.B. [C]	250
.262.	▶ 1430.262.12.B. [C]	262
.28.	▶ 1430.28 .12.B. [C]	275
.29.	▶ 1430.29 .12.B. [C]	287
.30.	▶ 1430.30 .12.B. [C]	300
.312.	▶ 1430.312.12.B. [C]	312
.325.	▶ 1430.325.12.B. [C]	325
.337.	▶ 1430.337.12.B. [C]	337
.350.	▶ 1430.350.12.B. [C]	350
.362.	▶ 1430.362.12.B. [C]	362
.375.	▶ 1430.375.12.B. [C]	375
.387.	▶ 1430.387.12.B. [C]	387
.400.	▶ 1430.400.12.B. [C]	400

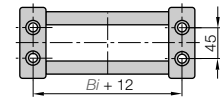

Part No. structure

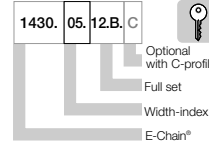

Full set, for both ends:

1430.05. 12.B

Single-part order:

1430.05. 12.B

Mounting bracket with bore

1430.05. 12.B

Mounting bracket with pin



Various interior separation possible

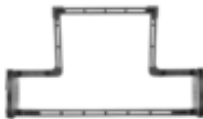

Extender crossbars for large hoses



KMA mounting brackets, locking

Additional Features

For more features ▶ see link below



▶ chapter 9

For new constructions:  
**Series "E4 light"**  
15050/15150/R19850 ▶ page 7.182

E4/light | Series 150·151·R198



igus® E-ChainSystems®

Phone +49- (0) 22 03-96 49-800  
Fax +49- (0) 22 03-96 49-222

igus® GmbH  
51147 Cologne

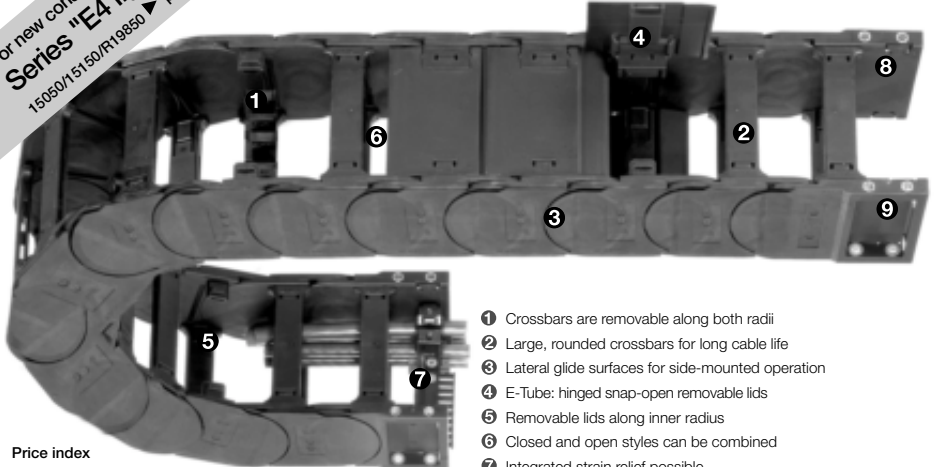

- ❶ Crossbars are removable along both radii
- ❷ Large, rounded crossbars for long cable life
- ❸ Lateral glide surfaces for side-mounted operation
- ❹ E-Tube: hinged snap-open removable lids
- ❺ Removable lids along inner radius
- ❻ Closed and open styles can be combined
- ❼ Integrated strain relief possible
- ❽ Mounting brackets available both locking and pivoting
- ❾ KMA mounting brackets with attachment points on all sides

Price index

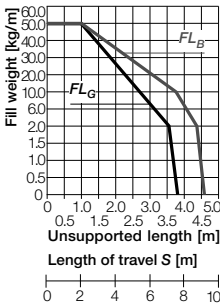

FL<sub>G</sub> = with straight upper run  
FL<sub>B</sub> = with permitted sag

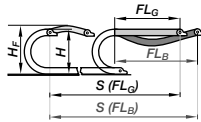

Series 150  
crossbars every link

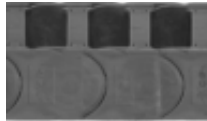

Series 151  
crossbars every 2<sup>nd</sup> link

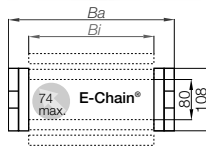

Series R198  
fully enclosed E-Tube

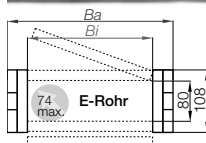

Part No.	Bi [mm]	Ba [mm]	R [mm] Bending Radii
150/151.05. ....0	50	80	150** 200 250
150/151/198.07. ....0*	75	105	300 350 400
150/151/198.10. ....0	100	130	500
150/151.11. ....0	112	143	
150/151/198.12. ....0	125	155	
150/151.13. ....0	137	168	
150/151/198.15. ....0	150	180	
150/151.16. ....0	162	193	
150/151.17. ....0	175	205	
150/151.18. ....0	187	218	
150/151/198.20. ....0	200	230	
150/151.21. ....0	212	243	
150/151.22. ....0	225	255	
150/151.23. ....0	237	268	
150/151/198.25. ....0	250	280	
150/151.26. ....0	262	293	
150/151/198.27. ....0	275	305	
150/151.28. ....0	287	318	
150/151/198.30. ....0	300	330	
150/151.31. ....0	312	343	
150/151.32. ....0	325	355	
150/151.33. ....0	337	368	
150/151/198.35. ....0	350	380	
150/151.36. ....0	362	393	
150/151.37. ....0	375	405	
150/151.38. ....0	387	418	
150/151/198.40. ....0	400	430	
150/151.41. ....0	412	443	
150/151.42. ....0	425	455	
150/151.43. ....0	437	468	
150/151.45. ....0	450	480	
150/151/198.46. ....0	462	493	
150/151.47. ....0	475	505	
150/151.48. ....0	487	518	
150/151.50. ....0	500	530	
150/151.51. ....0	512	543	
150/151.52. ....0	525	555	
150/151.53. ....0	537	568	
150/151.55. ....0	550	580	
150/151.60. ....0	600	630	

Radii for all widths!

\* Removable lid only,  
no hinged option  
\*\* Not available  
for R198

Part No. structure

150. 30. 300. 0

- Color black
- Bending radius
- Width
- Series



Order example 5,0 m complete E-Chain®

(indicate chain-lengths or number of links)

5,0 m (55 links) Series 150.30.300.0

+ 2 separators 511 assembled each 2<sup>nd</sup> link

+ 1 set mounting brackets with C-profile 1500.15.12.B.C

Supplement Part No. with required radius. Example: 150.30.300.0  
Bending radii listed above can be combined with every chain width!



# E4/light | Series 150-151·R198



150  
151  
R198  
E4/light

Pitch = 91 mm    Links per m = 11    Chain length =  $S/2 + K$

R	150	200	250	300	350	400	500
H <sup>+</sup> 25	410	510	610	710	810	910	1110
D	300	350	400	450	500	550	650
K	750	900	1050	1225	1375	1450	1675

The required clearance height is  $H_F = H + 60$  mm (with 3,0 kg/m fill weight). Please consult igus® if space is particularly restricted.

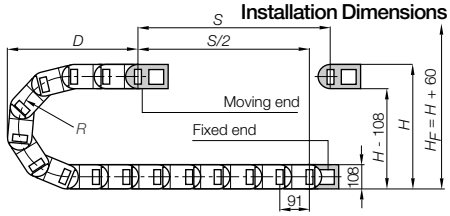
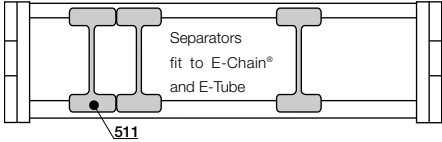

### Vertical Separator

unassembled	501
assembled	511



### Interior Separation

Full program ▶ page 7.154



### 1500/1980...1.B

Fixed end

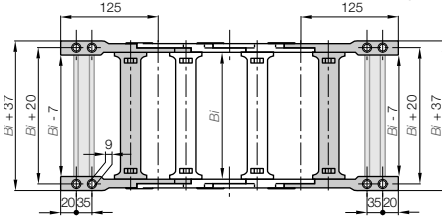

### 1500/1980...2.B

Moving end

### Moving end (with bore)

1500/1980...2.B

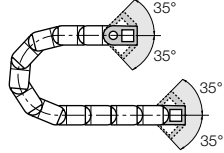

1500/1980...1.B  
Fixed end (with pin)

### Mounting Brackets



KMA pivoting - attachment  
with socket head cap bolt  
M8 DIN 912-8.8

For E-Chain®	Part No.	full set	Bi
width-index	optional with C-profile		[mm]
.05.	▶ 1500	.....05.12.B.	50
.06.	▶ 1500/1980	.....06.12.B.	65
.07.	▶ 1500/1980	.....07.12.B.	75
.10.	▶ 1500/1980	.....10.12.B.	100
.11.	▶ 1500	.....11.12.B.	112
.12.	▶ 1500/1980	.....12.12.B.	125
.13.	▶ 1500	.....13.12.B.	137
.15.	▶ 1500/1980	.....15.12.B.	150
.16.	▶ 1500	.....16.12.B.	162
.17.	▶ 1500	.....17.12.B.	175
.18.	▶ 1500	.....18.12.B.	187
.20.	▶ 1500/1980	.....20.12.B.	200
.21.	▶ 1500	.....21.12.B.	212
.22.	▶ 1500	.....22.12.B.	225
.23.	▶ 1500	.....23.12.B.	237
.25.	▶ 1500/1980	.....25.12.B.	250
.26.	▶ 1500	.....26.12.B.	262
.27.	▶ 1500/1980	.....27.12.B.	275
.28.	▶ 1500	.....28.12.B.	287
.30.	▶ 1500/1980	.....30.12.B.	300
.31.	▶ 1500	.....31.12.B.	312

For E-Chain®	Part No.	full set	Bi
width-index	optional with C-profile		[mm]
.32.	▶ 1500	.....32.12.B.	325
.33.	▶ 1500	.....33.12.B.	337
.35.	▶ 1500/1980	.....35.12.B.	350
.36.	▶ 1500	.....36.12.B.	362
.37.	▶ 1500	.....37.12.B.	375
.38.	▶ 1500	.....38.12.B.	387
.40.	▶ 1500/1980	.....40.12.B.	400
.41.	▶ 1500	.....41.12.B.	412
.42.	▶ 1500	.....42.12.B.	425
.43.	▶ 1500	.....43.12.B.	437
.45.	▶ 1500	.....45.12.B.	450
.46.	▶ 1500/1980	.....46.12.B.	462
.47.	▶ 1500	.....47.12.B.	475
.48.	▶ 1500	.....48.12.B.	487
.50.	▶ 1500	.....50.12.B.	500
.51.	▶ 1500	.....51.12.B.	512
.52.	▶ 1500	.....52.12.B.	525
.53.	▶ 1500	.....53.12.B.	537
.55.	▶ 1500	.....55.12.B.	550
.60.	▶ 1500	.....60.12.B.	600

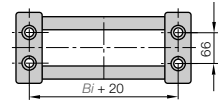

### Part No. structure

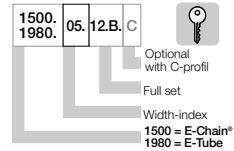

Full set, for both ends:

**1500.05.12.B**

Single-part order:

**1500.05.12.B**

Mounting bracket with bore

**1500.05.12.B**

Mounting bracket with pin

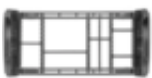

Various interior  
separation possible

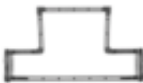

Extender crossbars  
for large hoses



KMA mounting  
brackets, locking



Steel mounting  
brackets, locking

### Additional Features

For more features  
▶ see link below



E4/light  
Inner height: 80 mm

Phone +49- (0) 22 03-96 49-800  
Fax +49- (0) 22 03-96 49-222



▶ chapter 9

For new constructions:  
**Series "E4/0"**  
220/R760 ▶ page 7-18

E4/0 | Series 22-23-R76

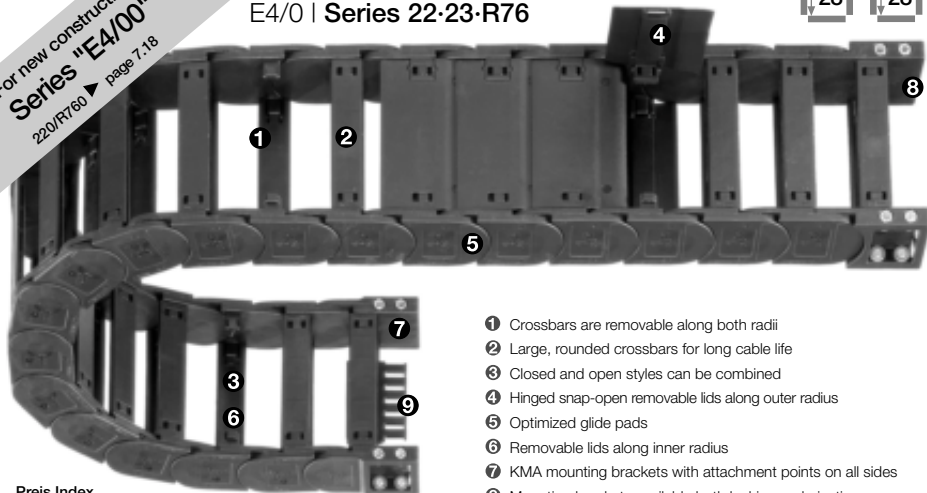

- ❶ Crossbars are removable along both radii
- ❷ Large, rounded crossbars for long cable life
- ❸ Closed and open styles can be combined
- ❹ Hinged snap-open removable lids along outer radius
- ❺ Optimized glide pads
- ❻ Removable lids along inner radius
- ❼ KMA mounting brackets with attachment points on all sides
- ❽ Mounting brackets available both locking and pivoting
- ❾ Integrated strain relief possible

Preis Index

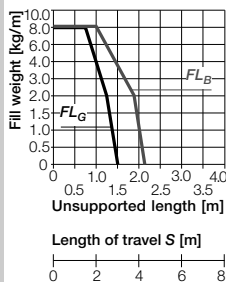

Unsupported length

FL<sub>G</sub> = with straight upper run

FL<sub>B</sub> = with permitted sag

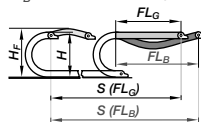

Series 22  
crossbars every link



Series 23  
crossbars every 2<sup>nd</sup> link

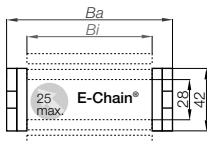

Series R76  
fully enclosed E-Tube

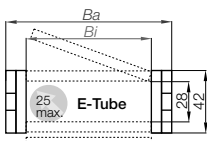

Part No.	Bi [mm]	Ba [mm]	R [mm] Bending Radii
22/23.040. ....	<input type="checkbox"/> .0	40 60	055* 063* 075
22/23/76.050. ....	<input type="checkbox"/> .0	50 70	100 125 150
22/23.062. ....	<input type="checkbox"/> .0	62 82	175 200 250
22/23.070. ....	<input type="checkbox"/> .0	70 90	Radii for all widths!
22/23/76.075. ....	<input type="checkbox"/> .0	75 095	
22/23/76.100. ....	<input type="checkbox"/> .0	100 120	
22/23/76.125. ....	<input type="checkbox"/> .0	125 145	
22/23/76.150. ....	<input type="checkbox"/> .0	150 170	
22/23/76.175. ....	<input type="checkbox"/> .0	175 195	
22/23/76.200. ....	<input type="checkbox"/> .0	200 220	
22/23/76.225. ....	<input type="checkbox"/> .0	225 245	
22/23/76.250. ....	<input type="checkbox"/> .0	250 270	
22/23.275. ....	<input type="checkbox"/> .0	275 295	
22/23/76.300. ....	<input type="checkbox"/> .0	300 320	

Part No. structure

22. 040.150.0

- Color black
- Bending radius
- Width
- Series

Order example 5,0 m complete E-Chain\*  
(indicate chain-lengths or number of links)

- 5,0 m (55 links) **Series 22.040.150.0**
- + 2 separators 2211 assembled each 2<sup>nd</sup> link
- + 1 set mounting brackets 220.040.12

\* Not available for R76

Supplement Part No. with required radius. Example: 22.040.150.0  
Bending radii listed above can be combined with every chain width!

Pitch = 46 mm    Links per m = 22    Chain length =  $S/2 + K$

R	055	063	075	100	125	150	175	200	250
H <sup>+20</sup>	154	170	194	244	294	344	394	444	544
D	125	133	145	170	195	220	145	270	320
K	265	290	330	410	485	565	645	725	820

The required clearance height is  $H_F = H + 40$  mm (with 1,0 kg/m fill weight). Please consult igus® if space is particularly restricted.

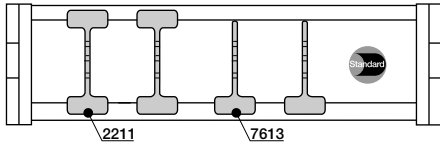
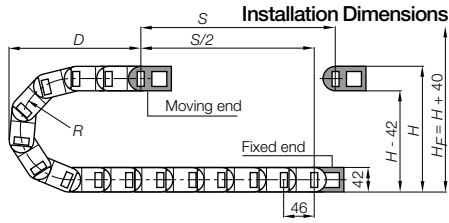

Vert. Separator (chain)	2
unassembled	2201
assembled	2211
Vert. Separator (tube)	3
unassembled	7603
assembled	7613

**Interior Separation**  
Full program ▶ page 7.18



**220/760...1**  
Moving end

**220/760...2**  
Fixed end

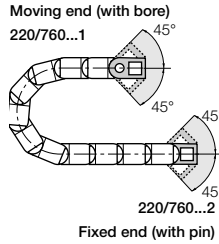
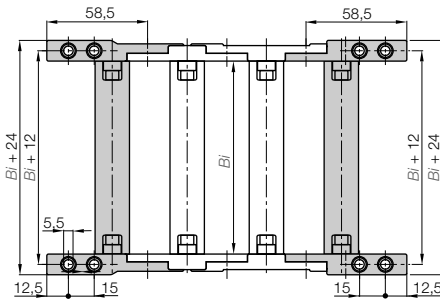

**Mounting Brackets**



KMA pivoting - attachment with socket head cap bolt M5 DIN 912-8.8

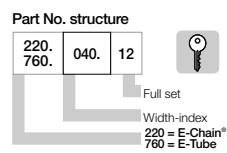
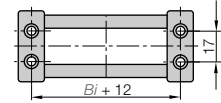

Full set, for both ends: **220.040.12**

Single-part order: **220.040.1**

Mounting bracket with bore **220.040.2**

Mounting bracket with pin

For E-Chain®	Part No.	Bi
width-index	full set	[mm]
.040.	▶ 220 .....040.12	40
.050.	▶ 220/760.050.12	50
.062.	▶ 220 .....062.12	62
.070.	▶ 220 .....070.12	70
.075.	▶ 220/760.075.12	75
.100.	▶ 220/760.100.12	100
.125.	▶ 220/760.125.12	125

For E-Chain®	Part No.	Bi
width-index	full set	[mm]
.150.	▶ 220/760.150.12	150
.175.	▶ 220/760.175.12	175
.200.	▶ 220/760.200.12	200
.225.	▶ 220/760.225.12	225
.250.	▶ 220/760.250.12	250
.275.	▶ 220 .....275.12	275
.300.	▶ 220/760.300.12	300

**Additional Features**



Interior separation with full-width shelves and shelves possible

KMA mounting brackets, locking

Strain relief tiewrap plate as individual part

For more features ▶ see link below



E4/0  
Inner height: 28 mm

Phone +49- (0) 22 03-96 49-800  
Fax +49- (0) 22 03-96 49-222

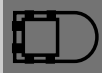

▶ chapter 9

For new constructions:  
**Series "E4/0"**  
280/290/R770 ▶ page 7.26

E4/0 | Series 28-29-R77

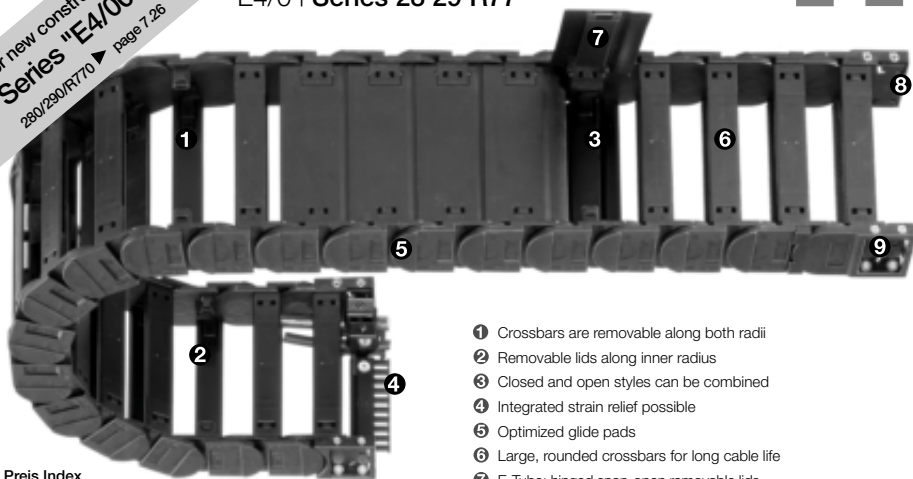

- ❶ Crossbars are removable along both radii
- ❷ Removable lids along inner radius
- ❸ Closed and open styles can be combined
- ❹ Integrated strain relief possible
- ❺ Optimized glide pads
- ❻ Large, rounded crossbars for long cable life
- ❼ E-Tube: hinged snap-open removable lids
- ❽ KMA mounting brackets with attachment points on all sides
- ❾ Mounting brackets available both locking and pivoting

Preis Index

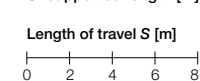
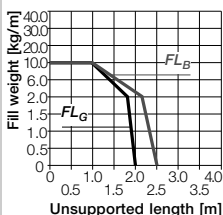

Unsupported length  
 $FL_G$  = with straight upper run  
 $FL_B$  = with permitted sag

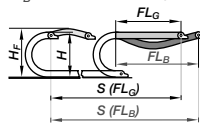

**Series 28**  
crossbars every link



**Series 29**  
crossbars every 2<sup>nd</sup> link

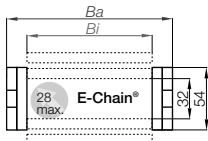

**Series R77**  
fully enclosed E-Tube

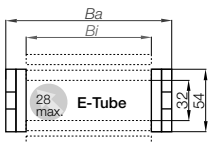

Part No.	Bi [mm]	Ba [mm]	R [mm] Bending Radii
28/29/77.05. . . . .	. . . . .0*	50 73	063** 075** 100**
28/29.06. . . . .	. . . . .0	68 91	125 150 175
28/29/77.07. . . . .	. . . . .0	75 98	200 220 250
28/29.087. . . . .	. . . . .0	87 110	300
28/29/77.10. . . . .	. . . . .0	100 123	Radii for all widths!
28/29/77.11. . . . .	. . . . .0	108 131	
28/29.112. . . . .	. . . . .0	112 136	
28/29/77.12. . . . .	. . . . .0	125 148	
28/29.137. . . . .	. . . . .0	137 161	
28/29/77.15. . . . .	. . . . .0	150 173	
28/29.162. . . . .	. . . . .0	162 186	
28/29/77.17. . . . .	. . . . .0	168 191	
28/29.18. . . . .	. . . . .0	175 198	
28/29.187. . . . .	. . . . .0	187 211	
28/29/77.20. . . . .	. . . . .0	200 223	
28/29.212. . . . .	. . . . .0	212 236	
28/29.23. . . . .	. . . . .0	225 248	
28/29.237. . . . .	. . . . .0	237 261	
28/29/77.25. . . . .	. . . . .0	250 273	
28/29.262. . . . .	. . . . .0	262 286	
28/29.28. . . . .	. . . . .0	275 298	
28/29.29. . . . .	. . . . .0	287 311	
28/29/77.30. . . . .	. . . . .0	300 323	
28/29.312. . . . .	. . . . .0	312 336	
28/29.325. . . . .	. . . . .0	325 348	
28/29.337. . . . .	. . . . .0	337 361	
28/29.350. . . . .	. . . . .0	350 373	
28/29.362. . . . .	. . . . .0	362 386	
28/29.375. . . . .	. . . . .0	375 398	
28/29.387. . . . .	. . . . .0	387 411	
28/29.400. . . . .	. . . . .0	400 423	

\* Removable lid only, no hinged option  
\*\* Not available for R77

Supplement Part No. with required radius. Example: 28.07.150.0  
Bending radii listed above can be combined with every chain width!

Part No.	structure
28. 07. 150. 0	

Color black  
Bending radius  
Width  
Series

**Order example 5,0 m complete E-Chain®**  
(indicate chain-lengths or number of links)

- 5,0 m (90 links) **Series 28.07.150.0**
- + 2 separators **281** assembled each 2<sup>nd</sup> link
- + 1 set mounting brackets with C-profile **280.07.12C**

Pitch = 56 mm    Links per m = 18    Chain length =  $S/2 + K$

R	063	075	100	125	150	175	200	220	250	300
H <sup>+20</sup>	180	205	255	305	355	405	455	495	555	655
D	130	150	175	200	225	250	275	295	325	375
K	340	380	465	550	620	700	780	850	940	1110

The required clearance height is  $H_f = H + 40$  mm (with 2,0 kg/m fill weight). Please consult igus® if space is particularly restricted.

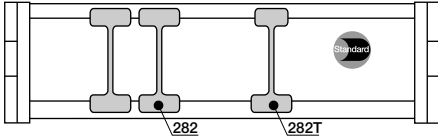
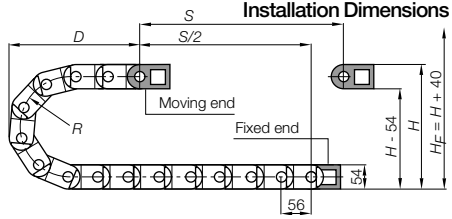

Vert. Separator (chain)	2.5
unassembled	281
assembled	282
Vert. Separator (tube)	2.5
unassembled	281T
assembled	282T

**Interior Separation**

Full program ▶ page 7.26



**280/770...1**

Moving end

**280/770...2**

Fixed end

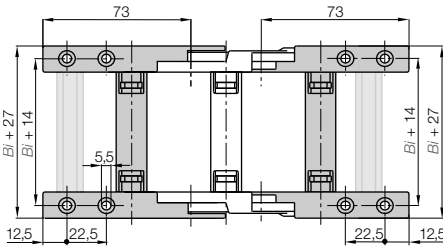

**Moving end (with bore)**

280/770...1

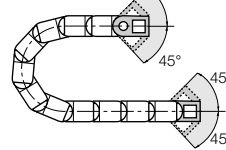

280/770...2

Fixed end (with pin)

**Mounting Brackets**



KMA pivoting - attachment with socket head cap bolt M5 DIN 912-8.8

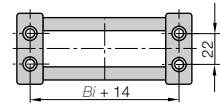

**Part No. structure**

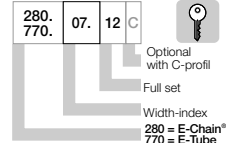

Full set, for both ends:

280.07. 12

Single-part order:

280.07. 1

Mounting bracket with bore

280.07. 2

Mounting bracket with pin

For E-Chain® Part No. full set		
width-index	optional with C-profile	Bi
.05.	280/770.05.12 C	50
.06.	280 .....06.12 C	68
.07.	280/770.07.12 C	75
.087.	280 .....087.12 C	87
.10.	280/770.10.12 C	100
.11.	280/770.11.12 C	108
.112.	280 .....112.12 C	112
.12.	280/770.12.12 C	125
.137.	280 .....137.12 C	137
.15.	280/770.15.12 C	150
.162.	280/ .....162.12 C	162
.17.	280/770.17.12 C	168
.18.	280 .....18.12 C	175
.187.	280 .....187.12 C	187
.20.	280/770.20.12 C	200
.212.	280 .....212.12 C	212

For E-Chain® Part No. full set		
width-index	optional with C-profile	Bi
.23.	280 .....23.12 C	225
.237.	280 .....237.12 C	237
.25.	280/770.25.12 C	250
.262.	280 .....262.12 C	262
.28.	280 .....28.12 C	275
.29.	280 .....29.12 C	287
.30.	280/770.30.12 C	300
.312.	280 .....312.12 C	312
.325.	280 .....325.12 C	325
.337.	280 .....337.12 C	337
.350.	280 .....350.12 C	350
.362.	280 .....362.12 C	362
.375.	280 .....375.12 C	375
.387.	280 .....387.12 C	387
.400.	280 .....400.12 C	400

Various interior separation possible

Extension links for very large E-Chains®

Extender crossbars for large hoses

KMA mounting brackets, locking

Steel mounting brackets, locking

**Additional Features**

For more features ▶ see link below



E4/0 Inner height: 32 mm

Phone +49- (0) 22 03-96 49-800  
Fax +49- (0) 22 03-96 49-222

For new constructions:  
**Series "E4/0"**  
380/390/R780 ▶ page 7.36

E4/0 | Series 38-39-R78



igus® E-ChainSystems®

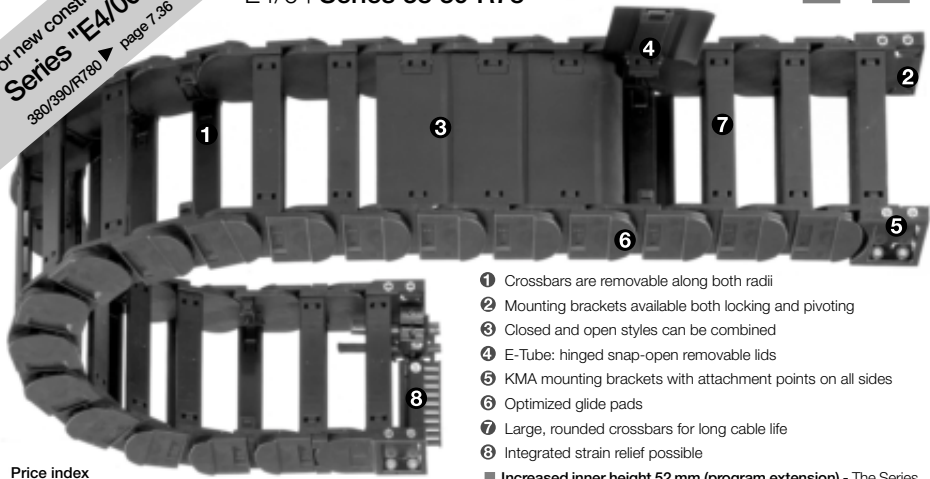

- ❶ Crossbars are removable along both radii
- ❷ Mounting brackets available both locking and pivoting
- ❸ Closed and open styles can be combined
- ❹ E-Tube: hinged snap-open removable lids
- ❺ KMA mounting brackets with attachment points on all sides
- ❻ Optimized glide pads
- ❼ Large, rounded crossbars for long cable life
- ❽ Integrated strain relief possible

Price index

Series 38      Series 39      Series R78

■ Increased inner height 52 mm (program extension) - The Series Part No. 38022 E-Chain®, with an increased inner height of 52 mm is available for unsupported applications ▶ page 12.46

Phone +49- (0) 22 03-96 49-800  
Fax +49- (0) 22 03-96 49-222

igus® GmbH  
51147 Cologne

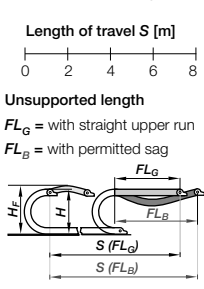
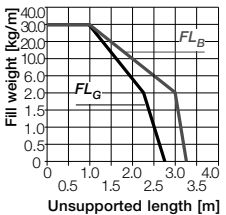

**Series 38**  
crossbars every link

**Series 39**  
crossbars every 2<sup>nd</sup> link

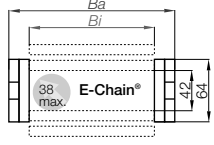

**Series R78**  
fully enclosed E-Tube

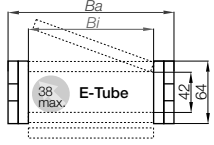

Part No.	Bi [mm]	Ba [mm]	R [mm] Bending Radii
38/39/78.05. . . . .	<input type="checkbox"/> .0*	50 77	75** 100** 115**
38/39.06. . . . .	<input type="checkbox"/> .0	68 95	125 150 170
38/39/78.07. . . . .	<input type="checkbox"/> .0	75 102	200 215 250
38/39.087. . . . .	<input type="checkbox"/> .0	87 115	300 350
38/39/78.10. . . . .	<input type="checkbox"/> .0	100 127	
38/39/78.11. . . . .	<input type="checkbox"/> .0	108 135	
38/39.112. . . . .	<input type="checkbox"/> .0	112 140	
38/39/78.12. . . . .	<input type="checkbox"/> .0	125 152	
38/39.137. . . . .	<input type="checkbox"/> .0	137 165	
38/39/78.15. . . . .	<input type="checkbox"/> .0	150 177	
38/39.162. . . . .	<input type="checkbox"/> .0	162 190	
38/39/78.17. . . . .	<input type="checkbox"/> .0	168 195	
38/39.18. . . . .	<input type="checkbox"/> .0	175 202	
38/39.187. . . . .	<input type="checkbox"/> .0	187 215	
38/39/78.20. . . . .	<input type="checkbox"/> .0	200 227	
38/39.212. . . . .	<input type="checkbox"/> .0	212 240	
38/39.23. . . . .	<input type="checkbox"/> .0	225 252	
38/39.237. . . . .	<input type="checkbox"/> .0	237 265	
38/39/78.25. . . . .	<input type="checkbox"/> .0	250 277	
38/39.262. . . . .	<input type="checkbox"/> .0	262 290	
38/39.28. . . . .	<input type="checkbox"/> .0	275 302	
38/39.29. . . . .	<input type="checkbox"/> .0	287 315	
38/39/78.30. . . . .	<input type="checkbox"/> .0	300 327	
38/39.312. . . . .	<input type="checkbox"/> .0	312 340	
38/39.325. . . . .	<input type="checkbox"/> .0	325 352	
38/39.337. . . . .	<input type="checkbox"/> .0	337 365	
38/39.350. . . . .	<input type="checkbox"/> .0	350 377	
38/39.362. . . . .	<input type="checkbox"/> .0	362 390	
38/39.375. . . . .	<input type="checkbox"/> .0	375 403	
38/39.387. . . . .	<input type="checkbox"/> .0	387 415	
38/39.400. . . . .	<input type="checkbox"/> .0	400 427	

Radii for all widths!

Part No. structure

38. 07. 150. 0

- Color black
- Bending radius
- Width
- Series

Order example 5,0 m complete E-Chain®  
(indicate chain-lengths or number of links)

5,0 m (75 links) **Series 38.07.150.0**

+ 2 separators **381** assembled each 2<sup>nd</sup> link

+ 1 set mounting brackets with C-profile **380.07.12C**

Supplement Part No. with required radius. Example: 38.07.150.0  
Bending radii listed above can be combined with every chain width!

Pitch = 67 mm    Links per m = 15    Chain length =  $S/2 + K$

R	075	100	115	125	150	170	200	215	250	300	350
H <sup>25</sup>	215	265	295	315	365	405	465	495	565	665	765
D	174	199	214	224	249	269	299	314	349	399	449
K	370	450	500	530	610	670	765	810	920	1080	1235

The required clearance height is  $H_F = H + 40$  mm (with 2,0 kg/m fill weight). Please consult igus® if space is particularly restricted.

Installation Dimensions

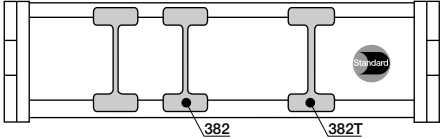
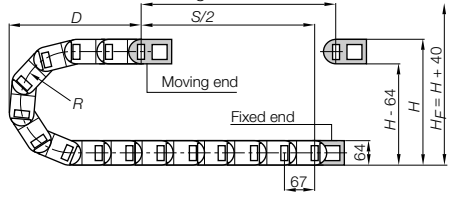

Vert. Separator (chain)	2.5
unassembled	381
assembled	382
Vert. Separator (tube)	3
unassembled	381T
assembled	382T

Interior Separation

Full program ▶ page 7.36



380/780...1

Moving end

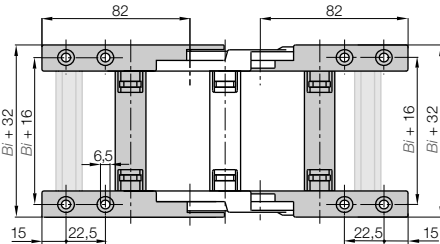

380/780...2

Fixed end

Moving end (with bore)

380/780...1

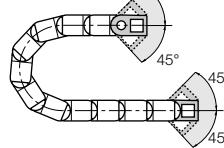

Fixed end (with pin)

Mounting Brackets



KMA pivoting - attachment with socket head cap bolt M6 DIN 912-8.8

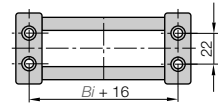

Part No. structure

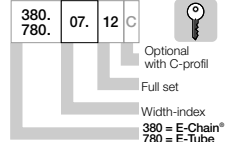

Full set, for both ends:

380.07. 12

Single-part order:

380.07. 1

Mounting bracket with bore

380.07. 2

Mounting bracket with pin

For E-Chain®	Part No. full set	Bi
width-index	optional with C-profile	[mm]
.05.	▶ 380/780.05.12 C	50
.06.	▶ 380 .....06.12 C	68
.07.	▶ 380/780.07.12 C	75
.087.	▶ 380 .....087.12 C	87
.10.	▶ 380/780.10.12 C	100
.11.	▶ 380/780.11.12 C	108
.112.	▶ 380 .....112.12 C	112
.12.	▶ 380/780.12.12 C	125
.137.	▶ 380 .....137.12 C	137
.15.	▶ 380/780.15.12 C	150
.162.	▶ 380 .....162.12 C	162
.17.	▶ 380/780.17.12 C	168
.18.	▶ 380 .....18.12 C	175
.187.	▶ 380 .....187.12 C	187
.20.	▶ 380/780.20.12 C	200
.212.	▶ 380 .....212.12 C	212

For E-Chain®	Part No. full set	Bi
width-index	optional with C-profile	[mm]
.23.	▶ 380 .....23.12 C	225
.237.	▶ 380 .....237.12 C	237
.25.	▶ 380/780.25.12 C	250
.262.	▶ 380 .....262.12 C	262
.28.	▶ 380 .....28.12 C	275
.29.	▶ 380 .....29.12 C	287
.30.	▶ 380/780.30.12 C	300
.312.	▶ 380 .....312.12 C	312
.325.	▶ 380 .....325.12 C	325
.337.	▶ 380 .....337.12 C	337
.350.	▶ 380 .....350.12 C	350
.362.	▶ 380 .....362.12 C	362
.375.	▶ 380 .....375.12 C	375
.387.	▶ 380 .....387.12 C	387
.400.	▶ 380 .....400.12 C	400

Additional Features

Various interior separation possible

Extension links for very large E-Chains®

Extender crossbars for large hoses

KMA mounting brackets, locking

Steel mounting brackets, locking

For more features ▶ see link below



E4/0 Inner height: 42 mm

Phone +49- (0) 22 03-96 49-800  
Fax +49- (0) 22 03-96 49-222



For new constructions:  
**Series "E4/0"**  
400/410/R880 ▶ page 7.46

E4/0 | Series 40-41-R88

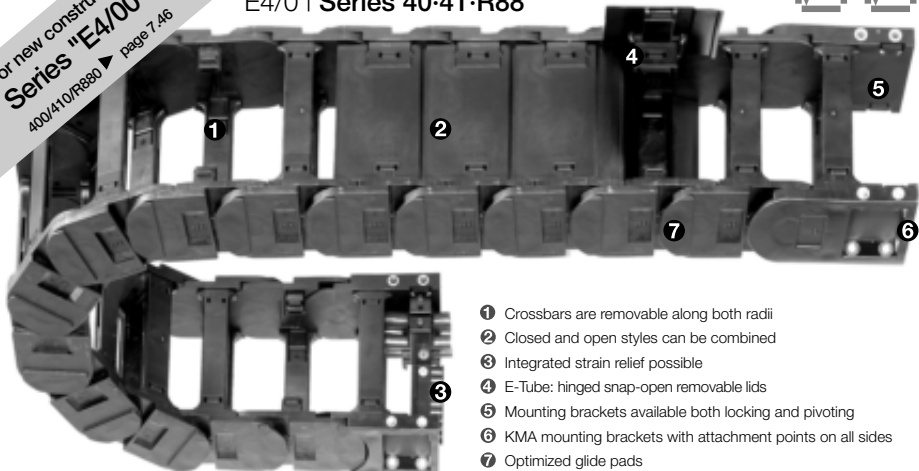

- 1 Crossbars are removable along both radii
- 2 Closed and open styles can be combined
- 3 Integrated strain relief possible
- 4 E-Tube: hinged snap-open removable lids
- 5 Mounting brackets available both locking and pivoting
- 6 KMA mounting brackets with attachment points on all sides
- 7 Optimized glide pads

Price index

Series 40      Series 41      Series R88

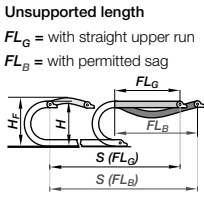
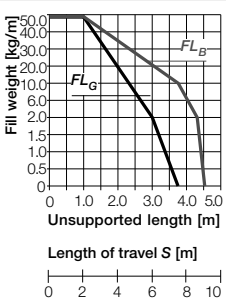

Series 40  
crossbars every link



Series 41  
crossbars every 2<sup>nd</sup> link

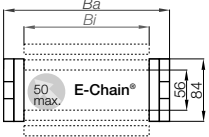

Series R88  
fully enclosed E-Tube

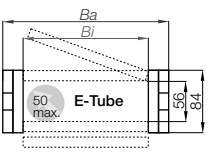

Part No.	Bi [mm]	Ba [mm]	R [mm] Bending Radii
40/41.05.	0	50	86
40/41.06.	0	65	101
40/41/88.07.	0*	75	111
40/41/88.10.	0	100	136
40/41.11.	0	112	149
40/41/88.12.	0	125	161
40/41.13.	0	137	174
40/41/88.15.	0	150	186
40/41.16.	0	162	199
40/41.17.	0	175	211
40/41.18.	0	187	224
40/41/88.20.	0	200	236
40/41.21.	0	212	249
40/41.22.	0	225	261
40/41.23.	0	237	274
40/41/88.25.	0	250	286
40/41.26.	0	262	299
40/41/88.27.	0	275	311
40/41.28.	0	287	324
40/41/88.30.	0	300	336
40/41.31.	0	312	349
40/41.32.	0	325	361
40/41.33.	0	337	374
40/41/88.35.	0	350	386
40/41.36.	0	362	399
40/41.37.	0	375	411
40/41.38.	0	387	424
40/41/88.40.	0	400	436
40/41.41.	0	412	449
40/41.42.	0	425	461
40/41.43.	0	437	474
40/41.45.	0	450	486
40/41/88.46.	0	462	499
40/41.47.	0	475	511
40/41.48.	0	487	524
40/41.50.	0	500	536
40/41.51.	0	512	549
40/41.52.	0	525	561
40/41.53.	0	537	574
40/41.55.	0	550	586
40/41.60.	0	600	636

Radii for all widths!

\* Removable lid only, no hinged option  
\*\* Not available for R88

Part No. structure

40. 20. 150. 0

Color black  
Bending radius  
Width  
Series

Order example 5,0 m complete E-Chain®  
(indicate chain-lengths or number of links)

5,0 m (55 links) **Series 40.20.150.0**  
+ 2 separators **411** assembled each 2<sup>nd</sup> link  
+ 1 set mounting brackets with C-profile **400.20.12C**

Supplement Part No. with required radius. Example: **40.20.150.0**  
Bending radii listed above can be combined with every chain width!

Pitch = 91 mm    Links per m = 11    Chain length =  $S/2 + K$

R	135	150	175	200	240	250	300	350	400	500
H <sup>+25</sup>	360	385	435	485	565	585	685	785	885	1085
D	270	285	310	335	375	385	435	485	535	635
K	650	750	825	900	1020	1050	1225	1340	1450	1775

The required clearance height is  $H_F = H + 50$  mm (with 2,0 kg/m fill weight). Please consult igus® if space is particularly restricted.

Installation Dimensions

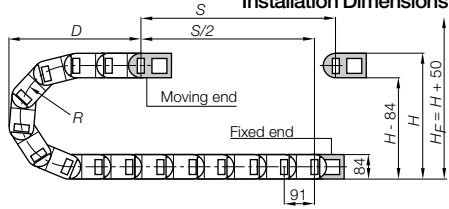

56

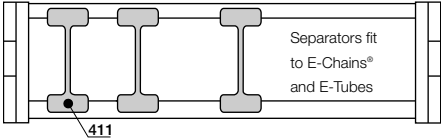

Standard

Vertical Separator

unassembled	401
assembled	411



Interior Separation

Full program ▶ page 7.46

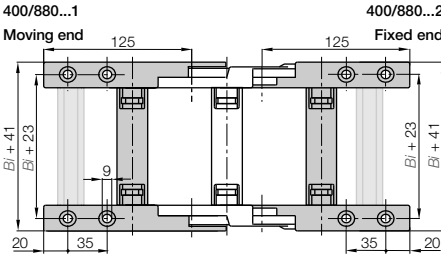

Moving end (with bore)

400/880...1

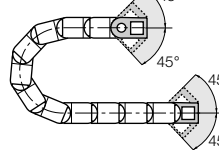

Fixed end (with pin)

Mounting Brackets



KMA pivoting - attachment with socket head cap bolt M8 DIN 912-8.8

For E-Chain®	Part No. full set	Bi
width-index	optional with C-profile	[mm]
.05.	▶ 400 .....05.12	50
.06.	▶ 400 .....06.12	65
.07.	▶ 400/880.07.12	75
.10.	▶ 400/880.10.12	100
.11.	▶ 400 .....11.12	112
.12.	▶ 400/880.12.12	125
.13.	▶ 400 .....13.12	137
.15.	▶ 400/880.15.12	150
.16.	▶ 400 .....16.12	162
.17.	▶ 400 .....17.12	175
.18.	▶ 400 .....18.12	187
.20.	▶ 400/880.20.12	200
.21.	▶ 400 .....21.12	212
.22.	▶ 400 .....22.12	225
.23.	▶ 400 .....23.12	237
.25.	▶ 400/880.25.12	250
.26.	▶ 400 .....26.12	262
.27.	▶ 400/880.27.12	275
.28.	▶ 400 .....28.12	287
.30.	▶ 400/880.30.12	300
.31.	▶ 400 .....31.12	312

For E-Chain®	Part No. full set	Bi
width-index	optional with C-profile	[mm]
.32.	▶ 400 .....32.12	325
.33.	▶ 400 .....33.12	337
.35.	▶ 400/880.35.12	350
.36.	▶ 400 .....36.12	362
.37.	▶ 400 .....37.12	375
.38.	▶ 400 .....38.12	387
.40.	▶ 400/880.40.12	400
.41.	▶ 400 .....41.12	412
.42.	▶ 400 .....42.12	425
.43.	▶ 400 .....43.12	437
.45.	▶ 400/880.45.12	450
.46.	▶ 400/880.46.12	462
.47.	▶ 400 .....47.12	475
.48.	▶ 400 .....48.12	487
.50.	▶ 400 .....50.12	500
.51.	▶ 400 .....51.12	512
.52.	▶ 400 .....52.12	525
.53.	▶ 400 .....53.12	537
.55.	▶ 400 .....55.12	550
.60.	▶ 400 .....60.12	600

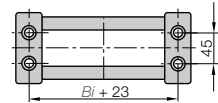

Part No. structure

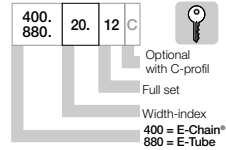

Full set, for both ends:

400.20. 12

Single-part order:

400.20. 1

Mounting bracket with bore

400.20. 2

Mounting bracket with pin

Various interior separation possible

Extension links for very large E-Chains®

Hinged crossbars

Extender crossbars for large hoses

KMA mounting brackets, locking

Steel mounting brackets, locking

Additional Features

For more features ▶ see link below



E4/0  
Inner height: 56 mm

Phone +49- (0) 22 03-96 49-800  
Fax +49- (0) 22 03-96 49-222

For new constructions:  
**Series "E4/4"**  
5050/51 50/R9850 ▶ page 7.1/36

E4/0 | Series 50-51-R98

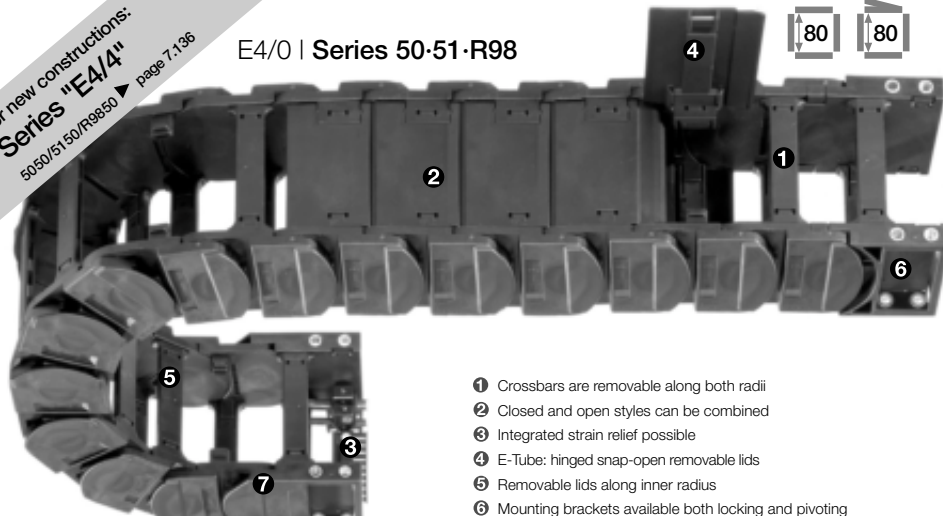

Price index



- ❶ Crossbars are removable along both radii
- ❷ Closed and open styles can be combined
- ❸ Integrated strain relief possible
- ❹ E-Tube: hinged snap-open removable lids
- ❺ Removable lids along inner radius
- ❻ Mounting brackets available both locking and pivoting
- ❼ KMA mounting brackets with attachment points on all sides

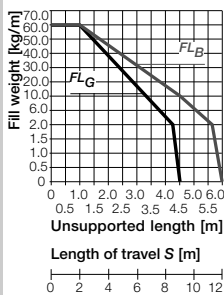

Unsupported length

$FL_G$  = with straight upper run

$FL_B$  = with permitted sag

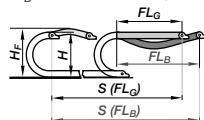

Series 50  
crossbars every link



Series 51  
crossbars every 2<sup>nd</sup> link



Series R98  
fully enclosed E-Tube



Part No.	Bi [mm]	Ba [mm]	R [mm] Bending Radii
50/51.05. ....	□.0	50	100
50/51.06. ....	□.0	65	115
50/51.08.07. ....	□.0*	75	125
50/51.08.10. ....	□.0	100	150
50/51.11. ....	□.0	112	163
50/51.08.12. ....	□.0	125	175
50/51.13. ....	□.0	137	188
50/51.08.15. ....	□.0	150	200
50/51.16. ....	□.0	162	213
50/51.17. ....	□.0	175	225
50/51.18. ....	□.0	187	238
50/51.08.20. ....	□.0	200	250
50/51.21. ....	□.0	212	263
50/51.22. ....	□.0	225	275
50/51.23. ....	□.0	237	288
50/51.08.25. ....	□.0	250	300
50/51.26. ....	□.0	262	313
50/51.08.27. ....	□.0	275	325
50/51.28. ....	□.0	287	338
50/51.08.30. ....	□.0	300	350
50/51.31. ....	□.0	312	363
50/51.32. ....	□.0	325	375
50/51.33. ....	□.0	337	388
50/51.08.35. ....	□.0	350	400
50/51.36. ....	□.0	362	413
50/51.37. ....	□.0	375	425
50/51.38. ....	□.0	387	438
50/51.08.40. ....	□.0	400	450
50/51.41. ....	□.0	412	463
50/51.42. ....	□.0	425	475
50/51.43. ....	□.0	437	488
50/51.45. ....	□.0	450	500
50/51.08.46. ....	□.0	462	513
50/51.47. ....	□.0	475	525
50/51.48. ....	□.0	487	538
50/51.50. ....	□.0	500	550
50/51.51. ....	□.0	512	563
50/51.52. ....	□.0	525	575
50/51.53. ....	□.0	537	588
50/51.55. ....	□.0	550	600
50/51.60. ....	□.0	600	650

R [mm] Bending Radii  
150\*\* 200 250  
300 350 400  
500 550 600  
650 1000

Radii for all widths!

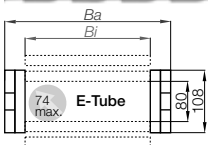
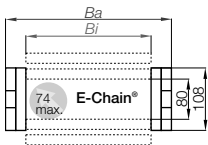

Part No. structure

50 25. 250. 0

- Color black
- Bending radius
- Width
- Series

Order example 5.0 m complete E-Chain®  
(indicate chain-lengths or number of links)

5.0 m (55 links) Series 50.25.250.0

+ 2 separators 511 assembled each 2<sup>nd</sup> link

+ 1 set mounting brackets with C-profile 500.25.12C

\* Removable lid only,  
no hinged option  
\*\* Not available  
for R98

Supplement Part No. with required radius. Example: 50.25.250.0  
Bending radii listed above can be combined with every chain width!

Pitch = 91 mm    Links per m = 11    Chain length =  $S/2 + K$

R	150	200	250	300	350	400	500	550	600	650	1000
H <sup>±25</sup>	410	510	610	710	810	910	1110	1210	1310	1410	2110
D	300	350	400	450	500	550	650	700	750	800	1150
K	750	900	1050	1225	1375	1450	1675	1850	2150	2250	3350

The required clearance height is  $H_f = H + 60$  mm (with 3,0 kg/m fill weight). Please consult igus® if space is particularly restricted.

Installation Dimensions

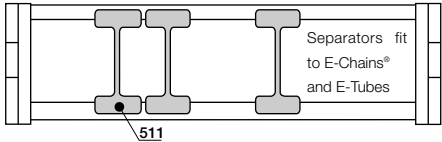
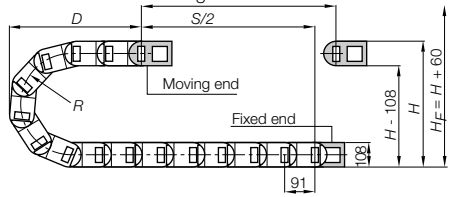

Vertical Separator

unassembled	501
assembled	511



Interior Separation

Full program ▶ page 7.120

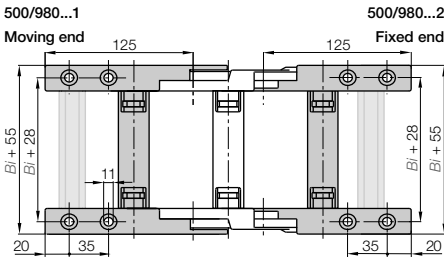

Moving end (with bore)

500/980...1

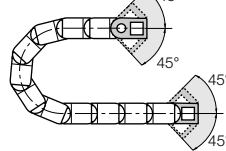

Fixed end (with pin)

Mounting Brackets



KMA pivoting - attachment with socket head cap bolt M8 DIN 912-8.8

For E-Chain®	Part No. full set	Bi
width-index	optional with C-profile	[mm]
.05.	▶ 500 .....05.12	50
.06.	▶ 500 .....06.12	65
.07.	▶ 500/980.07.12	75
.10.	▶ 500/980.10.12	100
.11.	▶ 500 .....11.12	112
.12.	▶ 500/980.12.12	125
.13.	▶ 500 .....13.12	137
.15.	▶ 500/980.15.12	150
.16.	▶ 500 .....16.12	162
.17.	▶ 500 .....17.12	175
.18.	▶ 500 .....18.12	187
.20.	▶ 500/980.20.12	200
.21.	▶ 500 .....21.12	212
.22.	▶ 500 .....22.12	225
.23.	▶ 500 .....23.12	237
.25.	▶ 500/980.25.12	250
.26.	▶ 500 .....26.12	262
.27.	▶ 500/980.27.12	275
.28.	▶ 500 .....28.12	287
.30.	▶ 500/980.30.12	300
.31.	▶ 500 .....31.12	312

For E-Chain®	Part No. full set	Bi
width-index	optional with C-profile	[mm]
.32.	▶ 500 .....32.12	325
.33.	▶ 500 .....33.12	337
.35.	▶ 500/980.35.12	350
.36.	▶ 500 .....36.12	362
.37.	▶ 500 .....37.12	375
.38.	▶ 500 .....38.12	387
.40.	▶ 500/980.40.12	400
.41.	▶ 500 .....41.12	412
.42.	▶ 500 .....42.12	425
.43.	▶ 500 .....43.12	437
.45.	▶ 500 .....45.12	450
.46.	▶ 500/980.46.12	462
.47.	▶ 500 .....47.12	475
.48.	▶ 500 .....48.12	487
.50.	▶ 500 .....50.12	500
.51.	▶ 500 .....51.12	512
.52.	▶ 500 .....52.12	525
.53.	▶ 500 .....53.12	537
.55.	▶ 500 .....55.12	550
.60.	▶ 500 .....60.12	600

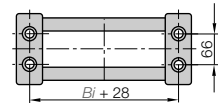

Part No. structure

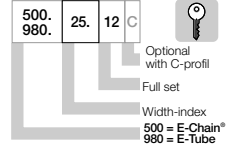

Full set, for both ends:

500.25. 12

Single-part order:

500.25. 1

Mounting bracket with bore

500.25. 2

Mounting bracket with pin

Various interior separation possible

Extension links for very large E-Chains®

Hinged crossbars

Extender crossbars for large hoses

KMA mounting brackets, locking

Steel mounting brackets, locking

Additional Features

For more features ▶ see link below



E4/0  
Inner height: 80 mm

Phone +49- (0) 22 03-96 49-800  
Fax +49- (0) 22 03-96 49-222

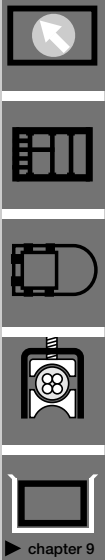

Line extension  
of Series 380 ▶ page 7.36

igus® E-ChainSystems®

Phone +49- (0) 22 03-96 49-800  
Fax +49- (0) 22 03-96 49-222

igus® GmbH  
51147 Cologne

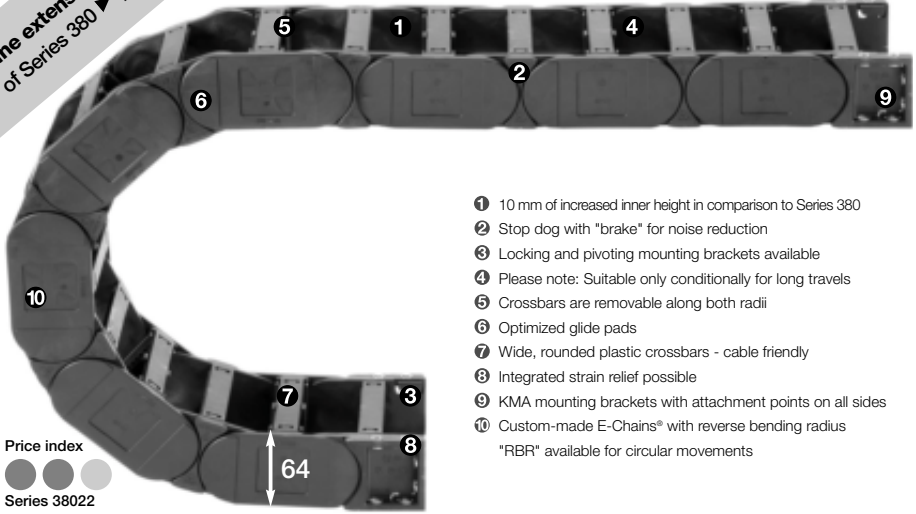

Price index  
● ● ● ● ●  
Series 38022

- ❶ 10 mm of increased inner height in comparison to Series 380
- ❷ Stop dog with "brake" for noise reduction
- ❸ Locking and pivoting mounting brackets available
- ❹ Please note: Suitable only conditionally for long travels
- ❺ Crossbars are removable along both radii
- ❻ Optimized glide pads
- ❼ Wide, rounded plastic crossbars - cable friendly
- ❽ Integrated strain relief possible
- ❾ KMA mounting brackets with attachment points on all sides
- ❿ Custom-made E-Chains® with reverse bending radius  
"RBR" available for circular movements

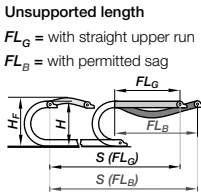
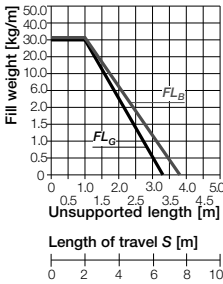

Serie 38022 -  
crossbars every link

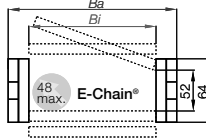

Part No.	Bi [mm]	Ba [mm]	R [mm]	Bending Radii
38022.05. ...	0	50	76	075 100 115
38022.06. ...	0	68	94	125 150 170
38022.07. ...	0	75	101	200 215 250
38022.087. ...	0	87	114	300 350
38022.10. ...	0	100	126	Radii for all widths!
38022.11. ...	0	108	134	
38022.112. ...	0	112	139	
38022.12. ...	0	125	151	
38022.137. ...	0	137	164	
38022.15. ...	0	150	176	
38022.162. ...	0	162	189	
38022.17. ...	0	168	194	
38022.18. ...	0	175	201	
38022.187. ...	0	187	214	
38022.20. ...	0	200	226	
38022.212. ...	0	212	239	
38022.23. ...	0	225	251	
38022.237. ...	0	237	264	
38022.25. ...	0	250	276	
38022.262. ...	0	262	289	
38022.28. ...	0	275	301	
38022.29. ...	0	287	314	
38022.30. ...	0	300	326	
38022.312. ...	0	312	339	
38022.325. ...	0	325	351	
38022.337. ...	0	337	364	
38022.350. ...	0	350	376	
38022.362. ...	0	362	389	
38022.375. ...	0	375	402	
38022.387. ...	0	387	414	
38022.400. ...	0	400	426	

Part No. structure

38022.400.300.0

- Color black
- Bending radius
- Width
- Series

Order example 5,0 m complete E-Chain®

(indicate chain-lengths or number of links)

- 5,0 m (75 links) Series 38022.400.300.0
  - + 2 separators 382213 assembled each 2<sup>nd</sup> link
  - + 1 set KMA mounting brackets 38022.400.1.12C
- (with odd numbers of links and integrated C-profile)

Supplement Part No. with required radius. Example: 38022.400.300.0  
Bending radii listed above can be combined with every chain width!

Pitch = 67 mm    Links per m = 15    Chain length =  $S/2 + K$

R	075	100	115	125	150	170	200	215	250	300	350
$H_{\pm 25}^0$	215	265	295	315	365	405	465	495	565	665	765
D	174	199	214	224	249	269	299	314	349	399	449
K	370	450	500	530	610	670	765	810	920	1080	1235

The required clearance height is  $H_F = H + 40$  mm (bei 2,0 kg/m Zusatzlast). Please consult igus® if space is particularly restricted.

### Installation Dimensions

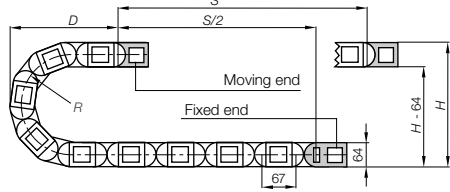

52

### Full range of interior separation for this Series ▶ page 12.46

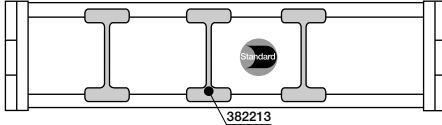

Standard

E-Chain® separator  
unassembled 382212  
assembled 382213



### Interior Separation

Full program ▶ page 12.48



Fixed end  
38022...2

Moving end  
38022...1

Moving end  
38022...1

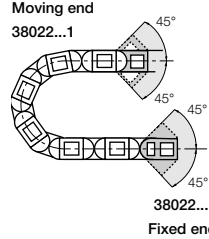
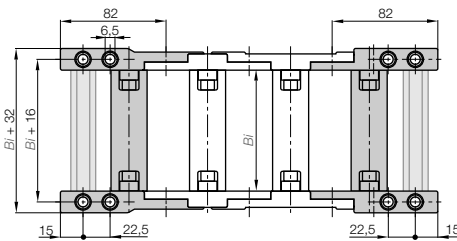

38022...2  
Fixed end

### Mounting Brackets



KMA pivoting - mounting with  
M5 socket head cup bolt  
(KMA = Polymer Metal Mounting Bracket)

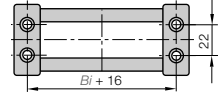

For E-Chain® width-index	Part No. full set	optional with C-profile	Insert odd [1] or even [2]	Bi [mm]
.05.	▶ 38022.05	□ .12 C		50
.06.	▶ 38022.06	□ .12 C		68
.07.	▶ 38022.07	□ .12 C		75
.087.	▶ 38022.087	□ .12 C		87
.10.	▶ 338022.10	□ .12 C		100
.11.	▶ 38022.11	□ .12 C		108
.112.	▶ 38022.112	□ .12 C		112
.12.	▶ 38022.12	□ .12 C		125
.137.	▶ 38022.137	□ .12 C		137
.15.	▶ 38022.15	□ .12 C		150
.162.	▶ 38022.162	□ .12 C		162
.17.	▶ 38022.17	□ .12 C		168
.18.	▶ 38022.18	□ .12 C		175
.187.	▶ 38022.187	□ .12 C		187
.20.	▶ 38022.20	□ .12 C		200
.212.	▶ 38022.212	□ .12 C		212

For E-Chain® width-index	Part No. full set	optional with C-profile	Insert odd [1] or even [2]	Bi [mm]
.23.	▶ 38022.23	□ .12 C		225
.237.	▶ 38022.237	□ .12 C		237
.25.	▶ 38022.25	□ .12 C		250
.262.	▶ 38022.262	□ .12 C		262
.28.	▶ 38022.28	□ .12 C		275
.29.	▶ 38022.29	□ .12 C		287
.30.	▶ 38022.30	□ .12 C		300
.312.	▶ 38022.312	□ .12 C		312
.325.	▶ 38022.325	□ .12 C		325
.337.	▶ 38022.337	□ .12 C		337
.350.	▶ 38022.350	□ .12 C		350
.362.	▶ 38022.362	□ .12 C		362
.375.	▶ 38022.375	□ .12 C		375
.387.	▶ 38022.387	□ .12 C		387
.400.	▶ 38022.400	□ .12 C		400

### Part No. structure

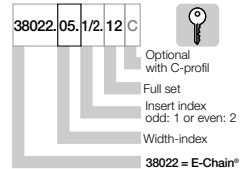

**Note:** The E4/00 System may end with either an inner side or an outer side link. Keep in mind that an outer side link always forms the first chain link at the moving end. The Part No. depend on an even or odd numbers of links. Please insert: index odd/even:

- [1] for odd number of links
- [2] for even number of links



Interior separation  
with locking shelves



Optional: Mounting bracket  
KMA, locking, Part No. 39022.XX

### Additional Features

For more features  
▶ see link below



igus® E-ChainSystems®

Line extension  
of Series 3838 ▶ page 7.104

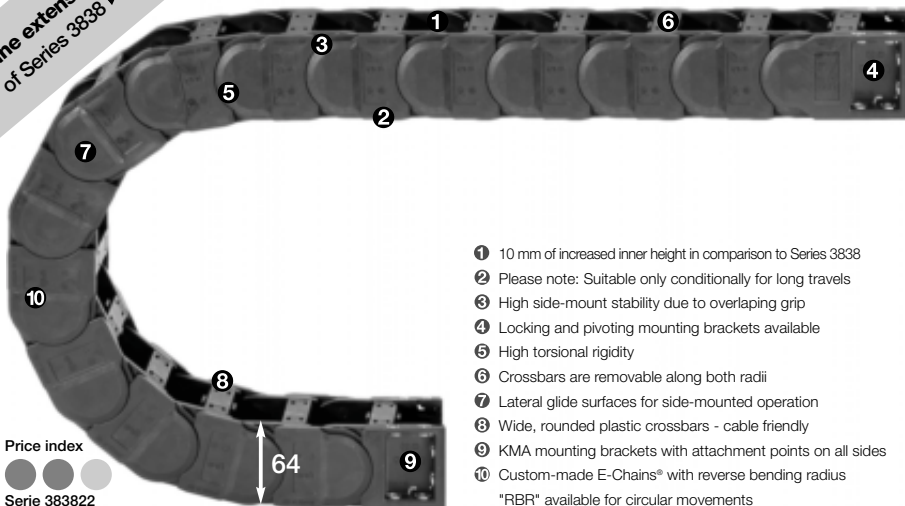

Price index  
● ● ● ● ●  
Serie 383822

- ① 10 mm of increased inner height in comparison to Series 3838
  - ② Please note: Suitable only conditionally for long travels
  - ③ High side-mount stability due to overlapping grip
  - ④ Locking and pivoting mounting brackets available
  - ⑤ High torsional rigidity
  - ⑥ Crossbars are removable along both radii
  - ⑦ Lateral glide surfaces for side-mounted operation
  - ⑧ Wide, rounded plastic crossbars - cable friendly
  - ⑨ KMA mounting brackets with attachment points on all sides
  - ⑩ Custom-made E-Chains® with reverse bending radius
- \*RBR\* available for circular movements

Phone +49- (0) 22 03-96 49-800  
Fax +49- (0) 22 03-96 49-222

igus® GmbH  
51147 Cologne

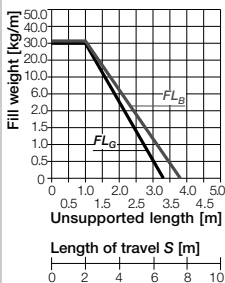

Unsupported length

FL<sub>G</sub> = with straight upper run

FL<sub>B</sub> = with permitted sag

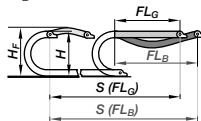

### Serie 383822 - crossbars every link

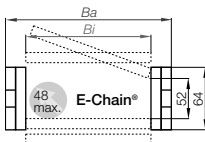

Part No.	Bi [mm]	Ba [mm]	R [mm]	Bending Radii
383822.05. ...	50	77	075	100 115
383822.06. ...	68	95	125	150 170
383822.07. ...	75	102	200	215 250
383822.087. ...	087	115	300	350
383822.10. ...	100	127	Radii for all widths!	
383822.11. ...	108	135		
383822.112. ...	112	140		
383822.12. ...	125	152		
383822.137. ...	137	165		
383822.15. ...	150	177		
383822.162. ...	162	190		
383822.17. ...	168	195		
383822.18. ...	175	202		
383822.187. ...	187	215		
383822.20. ...	200	227		
383822.212. ...	212	240		
383822.23. ...	225	252		
383822.237. ...	237	265		
383822.25. ...	250	277		
383822.262. ...	262	290		
383822.28. ...	275	302		
383822.29. ...	287	315		
383822.30. ...	300	327		
383822.312. ...	312	340		
383822.325. ...	325	352		
383822.337. ...	337	365		
383822.350. ...	350	377		
383822.362. ...	362	390		
383822.375. ...	375	402		
383822.387. ...	387	415		
383822.400. ...	400	427		

#### Part No. structure

383822. 30. 300. 0  
 Black = standard color, other colors  
 ▶ page 5.59  
 Bending radius  
 Width-index  
 Series



Order example 4,0 m complete E-Chain®  
 (indicate chain-lengths or number of links)

4,0 m (60 links) Series 383822.30.300.0  
 + 2 separators 382213 assembled each 2<sup>nd</sup> link  
 + 1 set KMA mounting brackets 383822.30.12[C]  
 (with integrated C-profile)

Supplement Part No. with required radius. Example: 383822.30. [300].0  
 Bending radii listed above can be combined with every chain width!



Pitch = 67 mm    Links per m = 15    Chain length =  $S/2 + K$

R	075	100	115	125	150	170	200	215	250	300	350
$H_{\pm 25}^0$	215	265	295	315	365	405	465	495	565	665	765
D	174	199	214	224	249	269	299	314	349	399	449
K	370	450	500	530	610	670	765	810	920	1080	1235

The required clearance height is  $H_f = H + 40$  mm (with 2,0 kg/m fill weight). Please consult igus® if space is particularly restricted.

Installation Dimensions

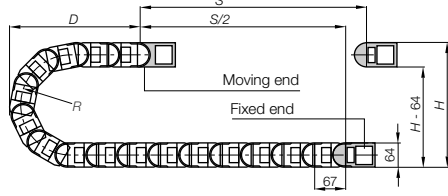

System E4/4  
Inner height: 52 mm

Full range of interior separation for this Series ▶ page 12.46

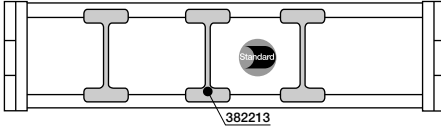

E-Chain® separator  
unassembled 382212  
assembled 382213



Interior Separation

Full program ▶ page 12.48



Fixed end  
383822...2

Moving end  
383822...1

Moving end  
383822...1

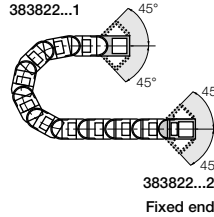
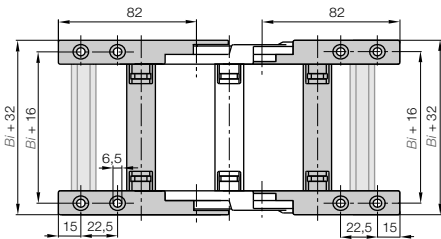

Mounting Brackets

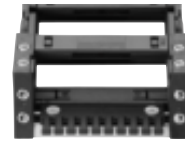

KMA pivoting - mounting with  
M6 socket head cup bolt  
(KMA = Polymer Metal Mounting Bracket)

For E-Chain®	Part No. full set	Bi
width-index	optional with C-profile	[mm]
.05.	383822.05 .12 C	50
.06.	383822.06 .12 C	68
.07.	383822.07 .12 C	75
.087.	383822.087 .12 C	87
.10.	383822.10 .12 C	100
.11.	383822.11 .12 C	108
.112.	383822.112 .12 C	112
.12.	383822.12 .12 C	125
.137.	383822.137 .12 C	137
.15.	383822.15 .12 C	150
.162.	383822.162 .12 C	162
.17.	383822.17 .12 C	168
.18.	383822.18 .12 C	175
.187.	383822.187 .12 C	187
.20.	383822.20 .12 C	200
.212.	383822.212 .12 C	212

For E-Chain®	Part No. full set	Bi
width-index	optional with C-profile	[mm]
.23.	383822.23 .12 C	225
.237.	383822.237 .12 C	237
.25.	383822.25 .12 C	250
.262.	383822.262 .12 C	262
.28.	383822.28 .12 C	275
.29.	383822.29 .12 C	287
.30.	383822.30 .12 C	300
.312.	383822.312 .12 C	312
.325.	383822.325 .12 C	325
.337.	383822.337 .12 C	337
.350.	383822.350 .12 C	350
.362.	383822.362 .12 C	362
.375.	383822.375 .12 C	375
.387.	383822.387 .12 C	387
.400.	383822.400 .12 C	400

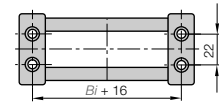

Part No. structure

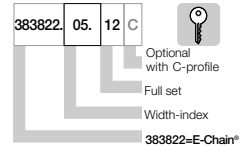

Full set, for both ends:

383822.05.12

Single-part order:

383822.05.1

Mounting bracket with bore

383822.05.2

Mounting bracket with pin



Interior separation  
with locking shelves



Optional: Mounting bracket KMA,  
locking, Part No. 393922.XX

Weitere Features

For more features  
▶ see link below



Comprehensive information ▶ on request!

Phone +49- (0) 22 03-96 49-800  
Fax +49- (0) 22 03-96 49-222



igus® E-ChainSystems®

Line extension  
of Series 38 ▶ page 12.36

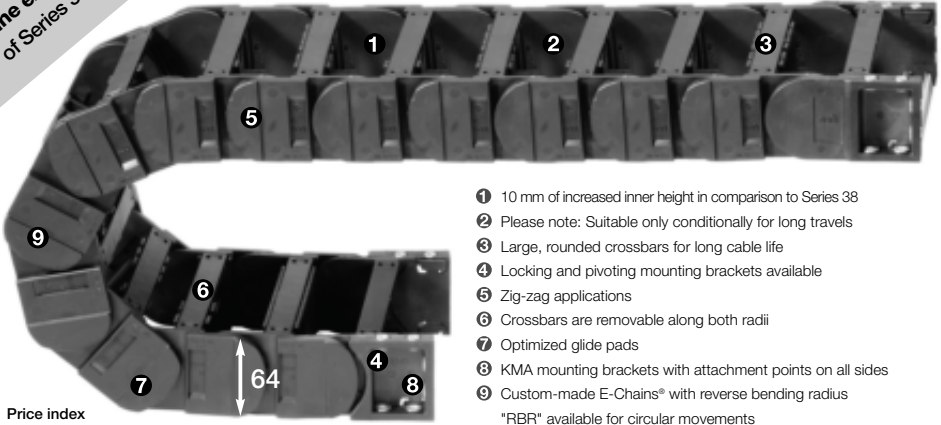

Price index  
● ● ●  
Serie 3822

- ❶ 10 mm of increased inner height in comparison to Series 38
- ❷ Please note: Suitable only conditionally for long travels
- ❸ Large, rounded crossbars for long cable life
- ❹ Locking and pivoting mounting brackets available
- ❺ Zig-zag applications
- ❻ Crossbars are removable along both radii
- ❼ Optimized glide pads
- ❽ KMA mounting brackets with attachment points on all sides
- ❾ Custom-made E-Chains® with reverse bending radius  
"RBR" available for circular movements

Phone +49- (0) 22 03-96 49-800  
Fax +49- (0) 22 03-96 49-222

igus® GmbH  
51147 Cologne

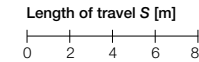
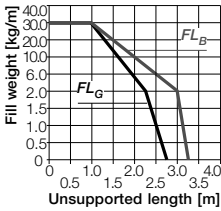

Length of travel S [m]  
Unsupported length  
 $FL_G$  = with straight upper run  
 $FL_B$  = with permitted sag

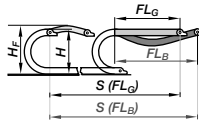

Serie 3822 -  
crossbars every link

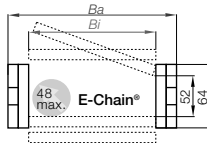
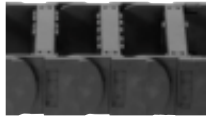

Part No.	Bi [mm]	Ba [mm]	R [mm]	Bending Radii
3822.05...0	50	77	075	100 115
3822.06...0	68	95	125	150 170
3822.07...0	75	102	200	215 250
3822.087...0	87	115	300	350
3822.10...0	100	127	Radii for all widths!	
3822.11...0	108	135		
3822.112...0	112	140		
3822.12...0	125	152		
3822.137...0	137	165		
3822.15...0	150	177		
3822.162...0	162	190		
3822.17...0	168	195		
3822.18...0	175	202		
3822.187...0	187	215		
3822.20...0	200	227		
3822.212...0	212	240		
3822.23...0	225	252		
3822.237...0	237	265		
3822.25...0	250	277		
3822.262...0	262	290		
3822.28...0	275	302		
3822.29...0	287	315		
3822.30...0	300	327		
3822.312...0	312	340		
3822.325...0	325	352		
3822.337...0	337	365		
3822.350...0	350	377		
3822.362...0	362	390		
3822.375...0	375	403		
3822.387...0	387	415		
3822.400...0	400	427		

Part No. structure

3822. 30. 300. 0  
 Black = standard color, other colors  
 ▶ page 5.59  
 Bending radius  
 Width-index  
 Series

Order example 4,0 m complete E-Chain®  
(indicate chain-lengths or number of links)

- 4,0 m (60 links) Series 3822.30.300.0
  - + 2 separators 382213 assembled each 2<sup>nd</sup> link
  - + 1 set KMA mounting brackets 3822.30.12[C]
- (with integrated C-profile)

Supplement Part No. with required radius. Example: 3822.30.300.0  
Bending radii listed above can be combined with every chain width!

Pitch = 67 mm    Links per m = 15    Chain length =  $\frac{S}{2} + K$

R	075	100	115	125	150	170	200	215	250	300	350
H* <sup>25</sup>	215	265	295	315	365	405	465	495	565	665	765
D	174	199	214	224	249	269	299	314	349	399	449
K	370	450	500	530	610	670	765	810	920	1080	1235

The required clearance height is  $H_F = H + 40$  mm (with 2,0 kg/m fill weight). Please consult igus® if space is particularly restricted.

Installation Dimensions

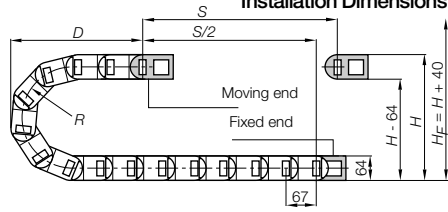

Full range of interior separation for this Series ► page 12.46

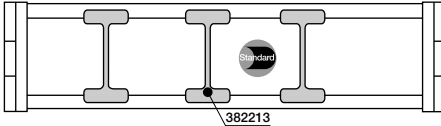

E-Chain® separator  
unassembled 382212  
assembled 382213



Interior Separation

Full program ► page 12.48



Moving end  
3822...1

Fixed end  
3822...2

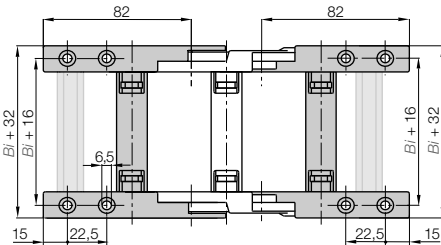

Moving end  
3822...1

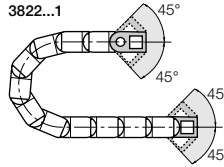

3822...2  
Fixed end

Mounting Brackets



KMA pivoting - mounting with  
M6 socket head cup bolt  
(KMA = Polymer Metal Mounting Bracket)

For E-Chain®	Part No. full set	Bi
width-index	optional with C-profile	[mm]
.05.	3822.05 . □.12 □	50
.06.	3822.06 . □.12 □	68
.07.	3822.07 . □.12 □	75
.087.	3822.087 . □.12 □	87
.10.	3822.10 . □.12 □	100
.11.	3822.11 . □.12 □	108
.112.	33822.112 . □.12 □	112
.12.	3822.12 . □.12 □	125
.137.	3822.137 . □.12 □	137
.15.	3822.15 . □.12 □	150
.162.	3822.162 . □.12 □	162
.17.	3822.17 . □.12 □	168
.18.	3822.18 . □.12 □	175
.187.	3822.187 . □.12 □	187
.20.	3822.20 . □.12 □	200
.212.	3822.212 . □.12 □	212

For E-Chain®	Part No. full set	Bi
width-index	optional with C-profile	[mm]
.23.	3822.23 . □.12 □	225
.237.	3822.237 . □.12 □	237
.25.	3822.25 . □.12 □	250
.262.	3822.262 . □.12 □	262
.28.	3822.28 . □.12 □	275
.29.	3822.29 . □.12 □	287
.30.	3822.30 . □.12 □	300
.312.	3822.312 . □.12 □	312
.325.	3822.325 . □.12 □	325
.337.	3822.337 . □.12 □	337
.350.	3822.350 . □.12 □	350
.362.	3822.362 . □.12 □	362
.375.	3822.375 . □.12 □	375
.387.	3822.387 . □.12 □	387
.400.	3822.400 . □.12 □	400

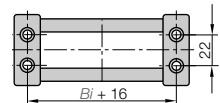

Part No. structure

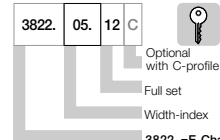

Full set, for both ends =

3822.05.12

Single-part order:

3822.05.1

Mounting bracket with bore

3822.05.2

Mounting bracket with pin



Various interior separation possible



Optional: Mounting bracket KMA, locking, Part No. 3922.XX

Weitere Features

For more features  
► see link below



System E4/0  
Inner height: 52 mm

Phone +49- (0) 22 03-96 49-800  
Fax +49- (0) 22 03-96 49-222



Vertical separator	
unassembled	382212
assembled	382213



### Option 1: Vertical separators

Vertical separators are used if a vertical subdivision of the E-Chain® interior is required -

By standard vertical separators are assembled every other E-Chain® link

- Standard separator 382212 for E-Chains® offers safe stability due to its wide base design, also when used with thick cables or hoses

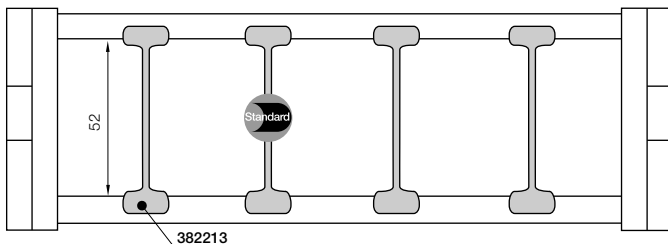

Separator, slotted	
unassembled	38221
assembled	38222



Locking separator	
unassembled	38228
assembled	38229



Locking vertical separator	
unassembled	382214
assembled	382215



Side plate	
unassembled	38223
assembled	38224



Slotted separator	
unassembled	38225
assembled	38226



### Option 2: Shelves

For applications involving many cables with different diameters. The Shelves can be arranged elevator-shifted with different bottoms within the entire E-Chain® width

- Shelf 2210.X can be combined with Separator, slotted 38221, Locking separator 38228, Locking vertical separator 382214, Side plate 3822 and Slotted separator 38225

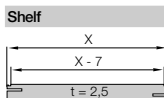
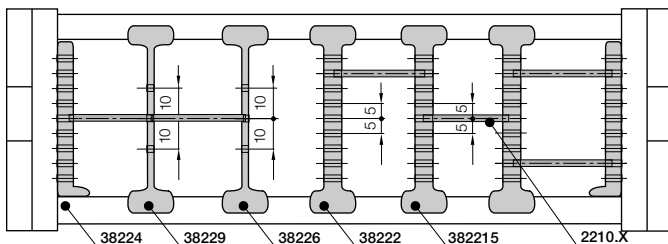

Width X [mm]	Part No. unassembled	Part No. assembled	Width X [mm]	Part No. unassembled	Part No. assembled
18	2200.18	2210.18	58	2200.58	2210.58
23	2200.23	2210.23	68	2200.68	2210.68
28	2200.28	2210.28	73	2200.73	2210.73
33	2200.33	2210.33	88	2200.88	2210.88
38	2200.38	2210.38	99	2200.99	2210.99
43	2200.43	2210.43	124	2200.124	2210.124
48	2200.48	2210.48	149	2200.149	2210.149

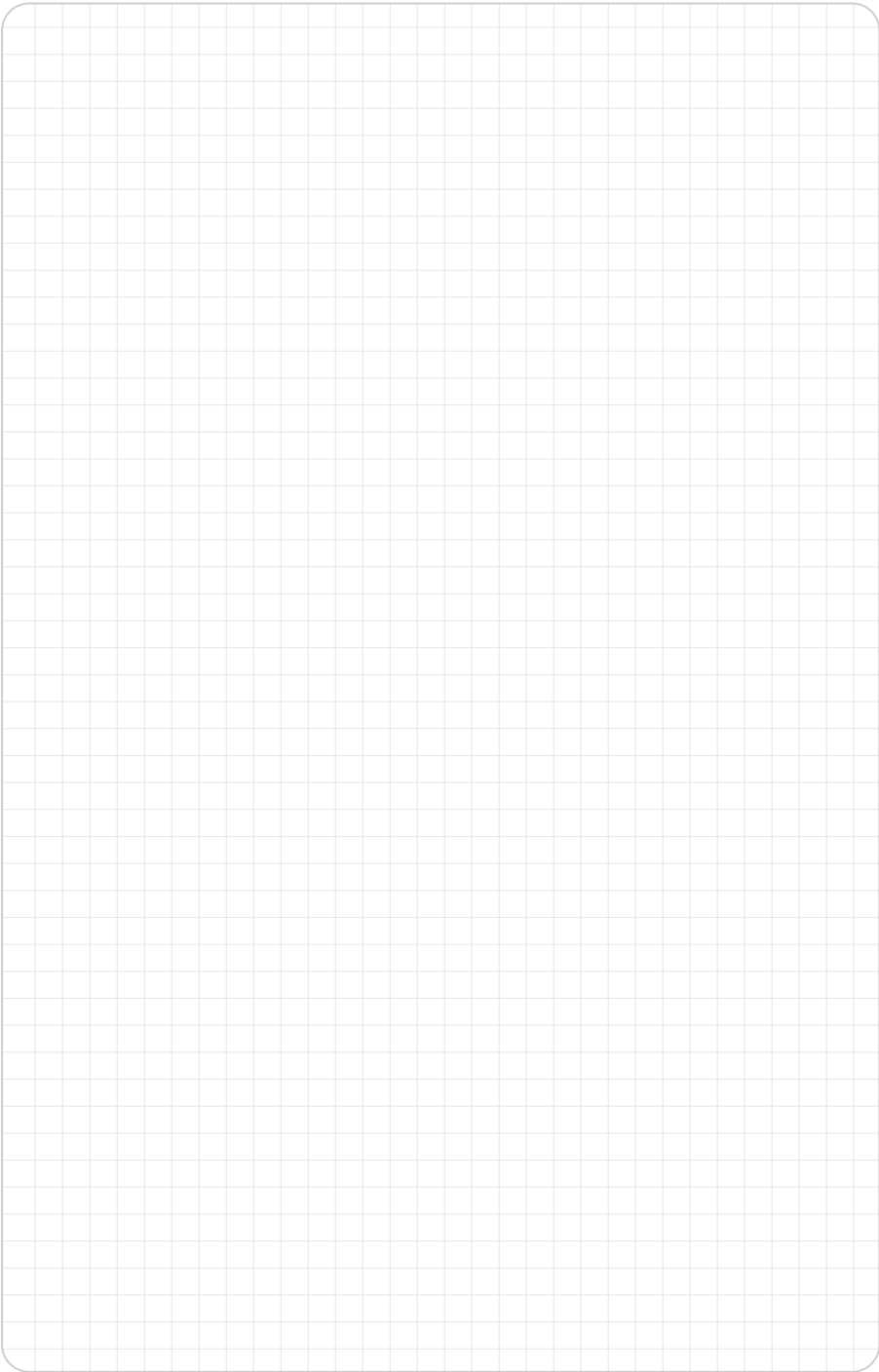

38022 / 383822 / 3822  
Interior Separation

Phone +49- (0) 22 03-96 49-800  
Fax +49- (0) 22 03-96 49-222



igus® E-ChainSystems®

Phone +49- (0) 22 03-96 49-800  
 Fax +49- (0) 22 03-96 49-222

igus® GmbH  
 51147 Cologne

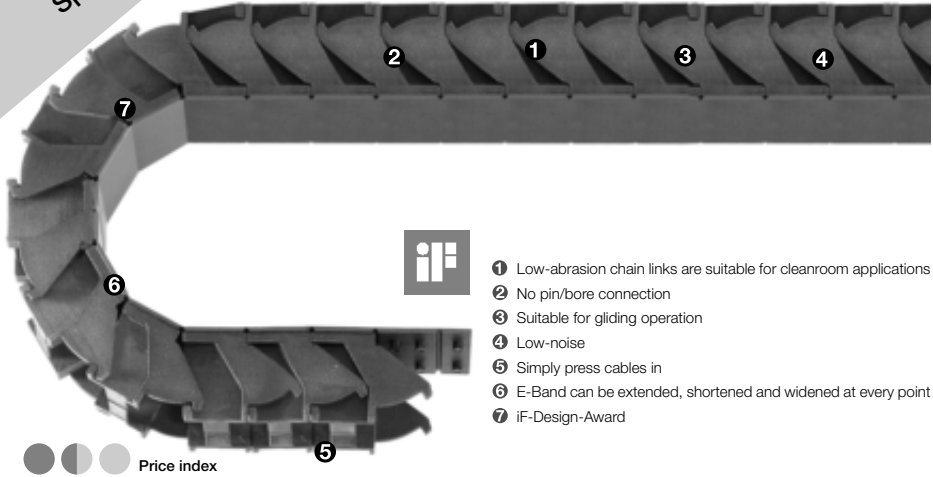

- ❶ Low-abrasion chain links are suitable for cleanroom applications
- ❷ No pin/bore connection
- ❸ Suitable for gliding operation
- ❹ Low-noise
- ❺ Simply press cables in
- ❻ E-Band can be extended, shortened and widened at every point
- ❼ IF-Design-Award

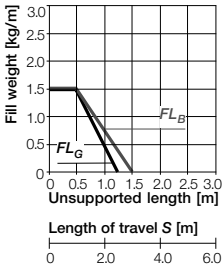

Unsupported length

$FL_G$  = with straight upper run

$FL_B$  = with permitted sag

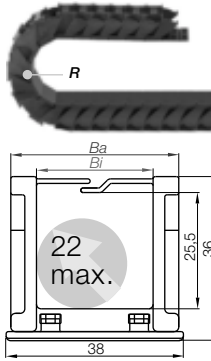
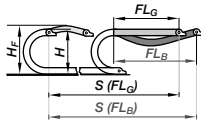

E-Band - split crossbar along the outer radius

Part No.	$Bi$ [mm]	$Ba$ [mm]	$R$ [mm] Bending Radii
EB20.025.□.0	25	36	045 063* 075* 100* 125* 150* 175* 200*
			Radii for all widths!
			*available upon request!

Supplement Part No. with required radius. Example: EB20.025.045.0  
 Bending radii listed above can be combined with every chain width!

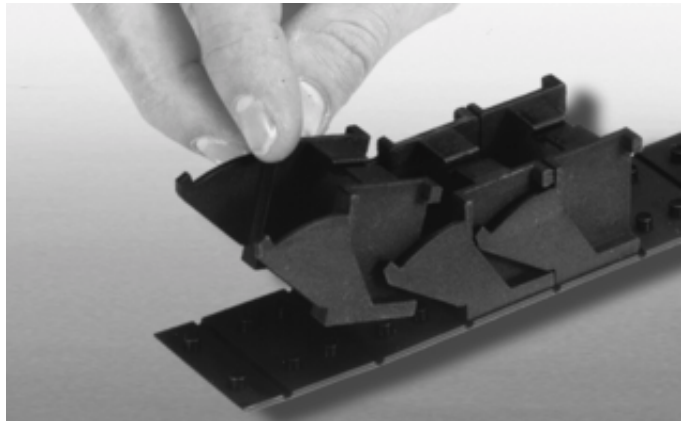

Modular band – simple installation

Part No. structure

EB20.025.045.0

- Color black
- Bending radius
- Width
- Series



Order example 2,0 m complete E-Chain®

(indicate chain-lengths or number of links)

1,0 m (40 links) Series EB20.025.045.0

+ 1 set mounting brackets EB20.025.12PZ

Pitch = 25 mm Links per m = 40 (2 Bänder/m) Chain length =  $S/2 + K$

R	045	063	075	100	125	150	175	200
H	162	198	222	272	322	372	422	472
D	110	128	140	165	190	215	240	265
K	200	250	300	375	450	525	600	675

The required clearance height is  $H_F = H + 30$  mm (with 0,3 kg/m fill weight). Please consult igus® if space is particularly restricted.

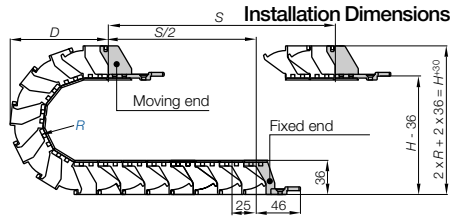

25,5

E-Band  
Inner height: 25,5 mm

EB20.025.2PZ  
Fixed end

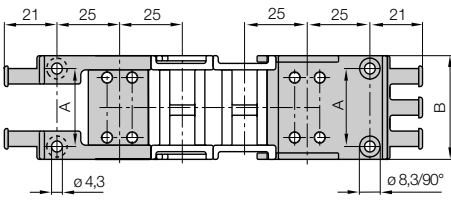

EB20.025.1PZ  
Moving end

Moving end  
EB20.025.1PZ

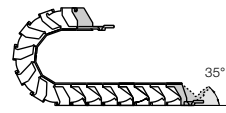

Mounting Brackets



EB20.025.2PZ  
Fixed end

One-piece mounting brackets with strain relief tiewrap plates

For E-Chain®	Part No.	Dimension A [mm]	Dimension B [mm]
	full set with tiewrap plate		
EB20.025.	EB20.025.12PZ	26	36

Tiewrap plates are possible at the moving end and/or the fixed end!

Phone +49- (0) 22 03-96 49-800  
Fax +49- (0) 22 03-96 49-222



Additional Features

For more features  
▶ see link below



E-Band can be widened at every point





# Fax-Forms



# igus<sup>®</sup> Addresses



<b>Date:</b>	<b>Phone:</b> +49- (0) 22 03 96 49 - 800 <b>Fax:</b> +49- (0) 22 03 96 49 - 222
<b>From:</b>	<b>To:</b> <b>igus® GmbH</b> Technical Sales Energy Chain Systems® P.O. Box 90 61 23 51147 Spicher Str. 1a
<b>Phone:</b>	
<b>Fax:</b>	

Fax-Forms

I would like to receive detailed information about the following products:

Printable media - catalogs for: Chainflex® special cables, Polymer Plain Bearings



- Over 750 Chainflex® cables for all applications
- Listed according to price categories
- Detailed description of cable assembly



- All technical specifications of the igus® plain bearing product range
- Many application examples and calculation assistance
- More than 9,600 polymer bearing products in one catalog

Phone +49- (0) 22 03-96 49-800  
Fax +49- (0) 22 03-96 49-222

Electronic media - CD-ROM: xigus, xigidur, crane presentation:



- Quick, easy configuration of E-ChainSystems®, all the way to 3D file generation
- New, clearer product catalog for E-Chains® and Chainflex® cables, with all information on one page
- Direct takeover of individual project data
- 87 different 3D and 55 different 2D file formats
- Program range of more than 70.000 items
- Entire bills of material can be placed into the shopping cart
- No installation, no costs



- Using the information you give us, the iglidur®, igubal® and DryLin® expert systems calculate their functionality and life cycle for you
- The entire catalog for plain bearings available on CD
- DXF library
- Photos, drawings, applications, etc.

igus® GmbH  
51147 Cologne

Internet: [www.igus.de](http://www.igus.de)  
E-mail: [info@igus.de](mailto:info@igus.de)

Please copy, fill in and fax to +49 22 03-9649 222 or visit our homepage ► [www.igus.de](http://www.igus.de) thank you!

12.53

igus® E-ChainSystems®

<b>Date:</b>	<b>Phone:</b> +49- (0) 22 03 96 49 - 800 <b>Fax:</b> +49- (0) 22 03 96 49 - 222
<b>From:</b>  <b>Phone:</b> <b>Fax:</b>	<b>To:</b> <b>igus® GmbH</b> Technical Sales Energy Chain Systems® P.O. Box 90 61 23 51147 Spicher Str. 1a

Phone +49- (0) 22 03-96 49-800  
Fax +49- (0) 22 03-96 49-222

Order No.

page \_\_\_\_\_ of \_\_\_\_\_ pages

igus® GmbH  
51147 Cologne

Item No.	igus® Order No.	Number	Price

Internet: [www.igus.de](http://www.igus.de)  
E-mail: [info@igus.de](mailto:info@igus.de)

We are ordering according to igus® general terms of sale. The prices are exclusive of the statutory value-added tax.

Delivery date:

Signature/stamp

<b>Date:</b>	<b>Phone:</b> +49- (0) 22 03 96 49 - 800 <b>Fax:</b> +49- (0) 22 03 96 49 - 222
<b>From:</b>  <b>Phone:</b> <b>Fax:</b>	<b>To:</b> <b>igus® GmbH</b> Technical Sales Energy Chain Systems® P.O. Box 90 61 23 51147 Spicher Str. 1a

Chain Type

Length

Cable/hose requirements:

---



---



---



---



---

**Interior separation / Vertical separators**  
Cable/hose layout within carrier

Cable/Hose End 1	Connector End 1	Union 1	Cable/Hose End 2	Union 2	Connector End 2

Fax-Forms

Phone +49- (0) 22 03-96 49-800  
Fax +49- (0) 22 03-96 49-222

igus® GmbH  
51147 Cologne

Internet: [www.igus.de](http://www.igus.de)  
E-mail: [info@igus.de](mailto:info@igus.de)

<b>Date:</b> _____	<b>Phone:</b> +49- (0) 22 03 96 49 - 800 <b>Fax:</b> +49- (0) 22 03 96 49 - 222
<b>From:</b>  <b>Phone:</b> _____ <b>Fax:</b> _____	<b>To:</b> <b>igus® GmbH</b> Technical Sales Energy Chain Systems® P.O. Box 90 61 23 51147 Spicher Str. 1a

Type of Application (check all that apply)

- 
- 
- 
- 
- 
- 
- 
- 
- 
- 

Installation Space

Travel S: \_\_\_\_\_ mm    **Fixed end:** center of the travel  yes or \_\_\_\_\_ mm from the center

Assembly point (floor, wall, console, etc.): \_\_\_\_\_ mm    Span (standard = 2 m): \_\_\_\_\_ mm

**Max. width permitted** (if applicable): \_\_\_\_\_ mm

**Guide trough?**  
 yes: if yes which  
 Dimensions:  $B_{Pi}$  \_\_\_\_\_ mm  
 Dimensions:  $H_{Pi}$  \_\_\_\_\_ mm

Dynamics

Speed: \_\_\_\_\_ [m/s]    Acceleration: \_\_\_\_\_ [m/s<sup>2</sup>]

Cycles/Day: \_\_\_\_\_    Days/Year: \_\_\_\_\_    Ø Outer diameter: \_\_\_\_\_

Environment

Temperature [°C]: \_\_\_\_\_    Humidity (%): \_\_\_\_\_    Dust, dirt, chips: \_\_\_\_\_

Special parameters: \_\_\_\_\_

Cables/Hoses

Number	Manufacturer/Type, No.	Conductor/AWG	Ø	Weight kg/m	Bending Radius

Further individual components desired:

- Energy Chains® / Energy Tubes
- Chainflex® cables/special conduits
- Guide trough
- Strain relief
- Harnessing
- On-site assembly
- Others
- Energy Chain®
- Energy Tube
- To be opened on both sides
- Along the outer radius
- Along the inner radius
- Special requests: \_\_\_\_\_

# Selection guide | Designing E-Chains®

1

## Dimensioning E-Chains®

Determine the size of the E-Chain® based on the specified installation space of your machine and/or of the selected filling (such as the number of cables/outer diameter of cable).

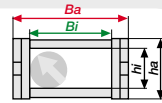

2

## Determine fill weight

Determine fill weight of (cables and/or media hoses) in [kg/m] using Chainflex® Quick Selector or manufacturer specification.

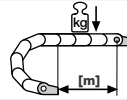

3

## Determine length of travel

Compare the fill weight calculated in (point 2) to the maximum fill weight of the selected E-Chain® and check suitability for "unsupported application".

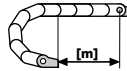

4

## Unsupported length

The maximum unsupported length initially depends on the fill weight and the E-Chain® selected. At the same time, there are three different levels of unsupported length: 1 **FL<sub>G</sub> - Recommended Range of Application** 2 **FL<sub>B</sub> - Permitted Sag** 3 **Critical Sag: Should never be operative installation!** Twice the value of the unsupported length determines the maximum travel in the "unsupported" type of operation. For evaluation the weight of the cables to be carried must be known, then an exact evaluation can be made using a diagram on the introductory page of the selected product. You will find the values for **FL<sub>G</sub>** and **FL<sub>B</sub>** in table form on the following pages of this chapter and for each Series in the catalog. They are necessary for: ● Finding the fill weight and length of travel for the appropriate E-Chain® ● Identifying the maximum load of the E-Chain® used.

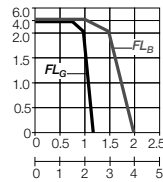
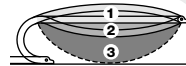

If there is suitability for "unsupported straight", then the selection follows the following criteria:

5

**Opening Principle** - The quick selection gives you an overview of the type of filling potential of the E-Chain®.



6

Determine the possible **Bending Radius R** [mm] of the E-Chain® with respect to the cable diameter.

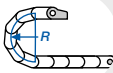

7

**Interior separation is possible with...**

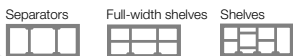

8

The **price index** gives you the possibility of making price comparisons of similar sizes within the igus® range



9

**Additional criteria** - for the appropriate selection of your E-Chains® such as pitch, permissible temperatures etc. are available under quick selection.

The following options are available if there is no possibility of self-supporting E-Chain® application:

A

You can choose the next and more stable E-Chain®, that can be operated "unsupported".

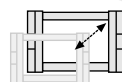

B

You can design your application to be "gliding".

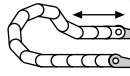

You can contact us directly or fax us your E-Chain® requests! We will respond immediately!

E-Chain® Part No: \_\_\_\_\_

Alternative E-Chain®-dimensions:

hi: \_\_\_\_\_ Bi: \_\_\_\_\_ ha: \_\_\_\_\_ Ba: \_\_\_\_\_

Fill weight: \_\_\_\_\_ kg/m

Length of travel: \_\_\_\_\_ m

Your Phone: \_\_\_\_\_

Your Fax: \_\_\_\_\_

Phone (+49) 0 22 03 - 96 49-0

Fax (+49) 0 22 03 - 96 49-222

## A

Abbreviation 1.4  
 Abrasion resistance 1.34  
 Acceleration 1.4  
 - cross 1.20, 1.23  
 - for short travels 1.10  
 Additional load,  
 maximum 1.4, 1.24, 1.25 (graphic)  
 Applications:  
 - "interlocked" 1.4  
 - combined motion 1.4  
 - E-Chain System® 1.6 et seq.  
 - gliding 1.4  
 - hanging 1.4, 1.20 et seq.  
 - horizontal 1.4  
 - installation design "zigzag" 1.21  
 - pictograms 1.4  
 - ReadyChain® 1.41 et seqq.  
 - short travels 1.8 et seqq.  
 - side-mounted 1.4 et seq., 1.24 et seq.  
 - turned (90° C) 1.24 et seq.  
 - vertical hanging 1.4, 1.20 et seqq.  
 - vertical standing 1.4, 1.22 et seq.  
 -, unsupported 1.8 et seqq.  
 Assembly 1.42  
 ATEX 1.35, 1.38

## B

Ball indentation hardness 1.39  
 Bend (FLB) 1.4, 1.8 et seqq., 1.12 et seqq.  
 Bending radius, reversed 1.4, 1.26, 1.29

## C

C profile 1.33  
 Cable 1.20, 1.22, 1.25, 1.28 et seqq.  
 Cable system 1.28 et seqq.  
 - bending radius R 1.29  
 - diameter 1.28  
 - general rules in E-Chains 1.28  
 - round 1.29  
 - separation 1.29  
 Calculation of the chain lengths 1.5  
 CE 1.38  
 CEI 1.38  
 Certificate 1.38  
 Chain: see E-Chain®  
 Chainfix 1.32 et seqq.  
 Chainflex® 1.32, 1.43  
 Chains  
 - calculation 1.5  
 - length  
 - tie-wrap plate 1.33  
 - turned (90° C) 1.24 et seqq.  
 - unsupported 1.4  
 Chemical resistance: see Stability, chemical  
 Chips 1.37  
 Circular movement 1.4, 1.26 et seqq.

- TwisterChain® 1.26  
 - with "RBR" (reverse bending radius) 1.26  
 - with standard E-Chain® 1.26  
 Clamp (Chainfix) 1.33  
 Cleanroom 1.36  
 Clear height 1.28  
 Coefficient of friction 1.18 et seqq.  
 Coefficient of surface friction 1.39  
 Cold 1.34  
 Colors (gumid-/igus®-E-Chain®) 1.39  
 Combined motion 1.4  
 Coolant, resistance to 1.37  
 Corkscrewing effect 1.30  
 Critical sag 1.8  
 Crossbar 1.31  
 CSA 1.38

## D

DESINA 1.38  
 Dielectric strength 1.39  
 Dimension units (abbreviations) 1.4  
 Dirt 1.37

## E

E modulus: see Elastic modulus 1.39  
 E-Chain®  
 - coefficients of surface friction 1.18  
 - colors 1.39  
 - ESD (gumid) 1.35  
 - gliding application:  
 - inner height 1.4  
 - inner radius 1.4  
 - inner width 1.4  
 - link height 1.4  
 - material data 1.39  
 - medium 1.12 et seqq.  
 - noise optimized 1.11  
 - outer radius 1.4  
 - outer width 1.4  
 - projecting length 1.4  
 - reverse 1.17  
 - large 1.14 et seqq.  
 - small 1.12 et seqq.  
 - standard supply 1.27  
 -, principle 1.17  
 E-Chain® pitch 1.4  
 E-Chain® length 1.4 et seqq.  
 E-Chain® separation 1.28  
 E-ChainSystem® 1.3, 1.6 et seqq.  
 - applications 1.6 et seqq.  
 - assembled 1.41 et seqq.  
 - hanging (graphic) 1.21  
 - ReadyChain® 1.41 et seqq.  
 - requirement 1.3  
 - standing (graphic) 1.21  
 Elastic modulus (E modulus) 1.39  
 Electric round cables 1.30

Electrostatic discharge (ESD) 1.35, 1.38  
 Elongation at break 1.39  
 Energy chain system: see E-ChainSystem®  
 Energy chain: see E-Chain®, etc.  
 ESD (Electrostatic Discharge) 1.35, 1.38  
 E-Tube 1.10, 1.37

## F

Filling 1.28 et seqq.; s.a. 1.20 et seqq.  
 - bending radius R 1.4, 1.29  
 - regulations 1.29  
 - strain relief 1.31  
 Filling weight 1.12  
 Fire resistance / flammability  
 (gumid G, gumid NB) 1.34  
 Fixed end 1.5  
 - at the center of travel 1.17 et seqq.  
 Flat cable 1.31  
 Formulas 1.4 et seqq.  
 Fraunhofer Institute of Production  
 Technology and Automation (IPA) 1.36, 1.38

## G

Gliding rail.17 et seqq.  
 Gliding:  
 - application 1.16 et seqq.  
 - long travels 1.16 et seqq.  
 Guiding trough 1.10  
 Guide trough 1.18 et seq., 1.27  
 - height 1.4  
 - width 1.4

## H

Hanging application 1.20 et seqq.  
 Heat 1.34  
 Height, clearance 1.28  
 Hose 1.20, 1.22, 1.25, 1.28 et seqq.  
 - bending radius R 1.29  
 - general rules in E-Chain® 1.28  
 - hydraulics 1.31  
 - pneumatics 1.31  
 Hydraulic hose 1.31

## I

iF Design Award 1.38  
 igumid 1.38 et seqq.  
 - colors 1.39  
 - ESD 1.35, 1.39  
 - G 1.34, 1.39  
 - NB 1.34, 1.39  
 - special solution 1.39  
 - TE 1.39  
 Impact strength 1.39  
 Installation  
 - "zigzag" 1.21  
 - circular movement 1.26 et seqq.  
 - hanging 1.20 et seqq.



- height, nominal (H) 1.5
- height, required (HF) 1.5
- space 1.3, 1.13
- standing 1.22 et seq.
- turned (90° C) 1.24 et seq.
- type 1.5
- vertical hanging 1.20
- Installation height, required 1.5
- Interbus 1.38
- Interior separation (shelving) 1.29
- IPA 1.34, 1.38
- ISO 9001 1.38

## L

- Laboratory 1.3, 1.42
- Lateral acceleration 1.11 et seq.
- Lateral expansion 1.31
- Load chart 1.12 et seqq.
- Load, alternation of 1.15, 1.29
- Lower run 1.17

## M

- Material data 1.39
- Maximum additional load 1.4, 1.24, 1.25 (graphic)
- Measured values, background noise corrected 1.11
- Modular design 1.21
- Motion, combined 1.4
- Mounting bracket 1.8 et seqq.
  - for gliding application 1.17
  - for unsupported applications 1.10
- rigid 1.22, 1.25
- vertical standing 1.22 et seq.
- Moving end, reduced 1.17
- Multiband chain 1.7

## N

- Noise level 1.11
- Noise optimized chain 1.11
- Nominal installation height 1.5

## P

- Particle abrasion 1.36
- Physikalisch-Technische Bundesanstalt (PTB), (Federal Physical and Technical Institute of Germany) 1.35
- Pictograms 1.4
- Planning 1.16, 1.21, 1.43
- Plastic gliding rail 1.18
- Pneumatic hose 1.31
- Pretension (camber) 1.5
  - hanging application 1.20
- Projecting length 1.4, 1.10, 1.17
- PTB (Physikalisch-Technische Bundesanstalt) (Federal Physical and Technical Institute of Germany) 1.35

## R

- Radiation resistance 1.34
- RAL numbers 1.39
- RBR (reverse bending radius) 1.26
  - order example 1.27
- ReadyChain® 1.41 et seqq.
- Reduced moving end 1.17
- Reverse bending radius: 1.4, 1.26, 1.29
- Reverse chain 1.17
- Rol E-Chain® 1.16
- Rollclip 1.31
- Roller energy chain 1.16
- Rotation angle 1.4
- Round cables, electric 1.30

## S

- Sag, critical 1.8
- Service life 1.10, 1.19
- Shelf 1.29
- Side-mounted application 1.24
- Space reserve 1.28 et seq.
- Spacers 1.25
- Stability classes 1.40
- Stability, chemical 1.40
  - of igumid G 1.37
- Standards 1.38
- Standing installation 1.22
- Straight (FLG) 1.8, 1.10, 1.12
- Strain
  - push-pull forces 1.34
  - relief 1.32
  - relief separator 1.33
  - tensile test 1.39
- Stroke height 1.11 et seq., 1.21 et seqq.
- Support (without) 1.4, 1.10, 1.22
- Support 1.10

## T

- Technical data:
  - vertical hanging 1.20
  - vertical standing 1.22
- Technical environment 1.34 et seqq.
  - ATEX 1.35, 1.38
  - Cleanroom and ESD 1.36
  - igumid ESD 1.35 et seq.
  - igumid G 1.34
  - igumid NB 1.34
  - IPA 1.36, 1.38
  - particle abrasion 1.36
  - PTB (Physikalisch-Technische Bundesanstalt), 1.35
- Test laboratory: see Laboratory
- Thermal conductivity 1.39
- Tiewrap plate 1.33
- Travel 1.12 et seqq.
  - (long travels) 1.16 et seqq.
  - general data

- gliding 1.16 et seqq.
- half 1.4
- long 1.16 et seqq.
- short 1.8 et seqq.
- Travel frequency 1.8
- Travel speed 1.4, 1.8, 1.15
- TÜV 1.38
- TwisterChain® 1.26

## U

- UL class 1.38
- Unsupported 1.8 et seqq.
  - definition 1.8
  - length 1.8 et seqq.
  - noise optimized 1.11
  - short travels 1.8 et seqq.
  - straight FLG 1.8, 1.10, 1.12
  - with bend FLB 1.8, 1.13, 1.15
- Unsupported applications 1.8 et seqq.
- Unsupported length, definition 1.8
- Upper run 1.12 et seqq., 1.17

## V

- Vacuum 1.34, 1.37
- VDE 1.38
- Vertical hanging 1.20 et seq.
- Vertical standing 1.22 et seq.

## W

- Wear 1.18
- Weathering 1.34

## Y

- Yield stress 1.39

## Z

- Zigzag (motion) 1.21



## igus® worldwide

### igus® offices

### igus® distributors

#### 1 Germany

##### igus® GmbH

Spicher Str. 1a  
51147 Köln (Porz-Lind)  
Postfach 90 61 23  
51127 Köln  
Phone +49-22 03-96 49-0  
Fax +49-22 03-96 49-222  
info@igus.de  
www.igus.de

#### 2 Australia

##### Treotham Automation Pty. Ltd.

Unit 36, 9 Powells Road,  
Brookvale NSW 2100  
Phone +61-2-99 07 17 88  
Fax +61-2-99 07 17 78  
info@treotham.com.au

#### 3 Austria

##### igus® Polymer Innovationen GmbH

Ort 55  
4843 Ampflwang  
Phone +43-76 75-04 05-0  
Fax +43-76 75-32 03  
igus-austria@igus.at

#### 4 Argentina

##### FABRIMATICA S.A.

Av. Varela 2966 C.P.  
1437 Buenos Aires  
Phone +54-11-49 18 00 09  
Fax +54-11-49 19 00 80  
ventas@fabrimatica.com

#### 5 Belgium

##### igus® B.W.B.A.

Mechelsesteenweg 453  
3020 Herent  
Phone +32-16-31 44 31  
Fax +32-16-31 44 39  
info@igus.be

#### 6 Brazil

##### igus® do Brasil Ltda.

Av. Eng. Alberto de Zagottis 655  
Santo Amaro  
04675-085 São Paulo - SP  
Phone +55-11-35 31 44 87  
Fax +55-11-35 31 44 88  
vendas@igus.com.br

#### 7 Bulgaria

##### Atlas Technik EOOD

BG-1612 Sofia  
PK 51  
Phone +359-885-23 25 95  
+359-897-98 16 69  
Phone/Fax +359-2-859 76 81  
al\_popoff@techno-link.com

#### 7 Bulgaria

##### Hennlich OOD, BG

4000 Plovdiv  
Konstantin Velichkov, 69, Et. 3  
Phone +359-32-511 326  
Phone/Fax +359-32-621 929  
office@hennlich.bg

#### 8 Canada

##### igus® Office Canada

201 Millway Ave.  
Concord  
Ontario L4K 5K8  
Phone +1-905-760 84 48  
Fax +1-905-760 86 88  
webmaster@igus.com

#### 9 China

##### igus® Shanghai Co., Ltd.

No. 28, Jiatai Road,  
Waigaoqiao Free Trade Zone  
Shanghai 200131, P.R.C.  
Phone +86-21-51 30 31 00  
Fax +86-21-51 30 31 00  
master@igus.com.cn

#### 10 China South

##### igus® China Guangzhou office

Room 2306, West Tower,  
Yangcheng International  
Commercial Center, Tiyu, East  
Road,  
Guangzhou 510620, P.R.C.  
Phone +86-20-38 87 17 26/7/8  
Fax +86-20-38 87 17 68  
guangzhou@igus.com.cn

#### 11 Croatia

##### Hennlich, Industrijska d.o.o.

Franje Woflita 4  
10000 Zagreb  
Phone +385-1-3 87 43 34  
Fax +385-1-3 87 43 36  
hennlich@hennlich.hr

#### 12 Czech Republic

##### Hennlich Industrietechnik spol. s r.o.

o.z. Lin-tech  
Česká ulice 9  
41201 Litoměřice  
Phone Chains +420-416-71 13 32  
Phone Bearings +420-416-71 13 39  
Fax +420-416-71 19 99  
lin-tech@hennlich.cz

#### 13 Denmark

##### igus® ApS

Postboks 243  
8800 Viborg  
Phone +45-86-60 33 73  
Fax +45-86-60 32 73  
info@igus.dk

#### 13 Denmark – E-Chains®

##### Solar AS

Industrievæg Vest 43  
6800 Vejler  
Phone +45-76-96 12 00  
Fax +45-76-36 47 59  
solar@solar.dk

#### 14 Finland – E-Chains®

##### SKS-mekaniikka Oy

Martinkyläntie 50  
01720 Vantaa  
Phone +358-20-764 65 22  
Fax +358-20-764 68 24  
mekaniikka@sks.fi

#### 14 Finland – Chainflex®

##### SKS-automaatio Oy

Martinkyläntie 50  
01720 Vantaa  
Phone +358-20-764 67 48  
Fax +358-20-764 68 20  
automaatio@sks.fi

#### 15 France

##### igus® SARL

49, avenue des Pépinières  
Parc Médicis  
94832 Fresnes Cedex  
Phone +33-1-49 84 04 04  
Fax +33-1-49 84 03 94  
info@igus.fr

#### 16 Greece – E-Chains®

##### Chrimotor s.a.

71, Sp. Patsi str.  
118 55 Athens  
Phone +30-210-411 31 33  
Fax +30-210-34 25 595  
info@chrimotor.gr

#### 16 Greece

##### Polymer Bearings;

J. & E. Papadopoulos S.A.  
23, Retaina Street  
185-45 Piraeus  
Phone +30-210-411 31 33  
Fax +30-210-411 67 81  
sales@papadopoulos-sa.com

#### 17 Hong Kong

##### Sky Top Enterprises Ltd

Room 1707, Block C, Wah Tat  
Ind Centre; Wah Sing Street;  
Kwai Chung; Hong Kong  
Phone +852-22 43 42 78  
Fax +852-22 43 42 79  
skytopy@ctimail.com

#### 18 Hungary

##### igus® Hungária Kft.

Fehér Srt. u. l. 7em.9  
11006 Budapest  
Phone +36-1-306-64 86  
Fax +36-1-431-03 74  
info@igus.hu

#### 18 Hungary

##### Tech-Con Kft.

Véső utca 9-11  
1133 Budapest  
Phone +36-1-412 41 61  
Fax +36-1-412 41 71  
tech-con@tech-con.hu

#### 19 India

##### igus® (India) Pvt. Ltd.

# 199/1, 22nd Main,  
HSR Layout, Agara Post,  
Bangalore - 560 102  
Phone +91-80-25 72 71-06  
Fax +91-80-25 72 71-08  
sales-india@igus.de

#### 20 Indonesia

##### Pt. Energi Canggih Indonesia

Kelapa Gading Selatan  
BJ 08 / 14  
Gading Serpong  
Tangerang 15610  
Phone +62-21-547 43 64  
Fax +62-21-547 43 65  
jakarta@energicanggih.com

#### 21 Iran

##### Tarnez Entiajat Fari Tehran

(TAF CO.)  
72, Inranshar Ave., Unit 5  
15816 Tehran, Iran  
Phone +98-21-8831 78 51  
Fax +98-21-8882 02 68  
info@taf-co.com

#### 22 Israel

##### Conlog LTD

P.O. Box 35 71  
Petach Tikva 49134  
Phone +972-3-926 95 95  
Fax +972-3-923 33 67  
conlog@conlog.co.il

#### 23 Italy

##### igus® S.r.l.

Via delle Rovedine, 4  
23899 Robbiate (LC)  
Phone +39-039 5906.1  
Fax +39-039 5906.222  
igusitalia@igus.it

#### 24 Japan

##### igus® k.k.

Arcacentral 7F, 1-2-1 Kinshi,  
Sumida-ku Tokyo JAPAN  
Zip 130-0013  
Phone +81 3 58 19 20 30  
Fax +81 3 58 19 20 55  
info@igus.co.jp

#### 25 Malaysia

##### Automation Industry & Systems

(M) SDN.BHD.  
50, Lorong Nagasari 11,  
Taman Nagasari  
13600 Prai, Penang  
Phone +60-4-390 56 07  
Fax +60-4-399 73 27  
autoind@ipo.jaring.my

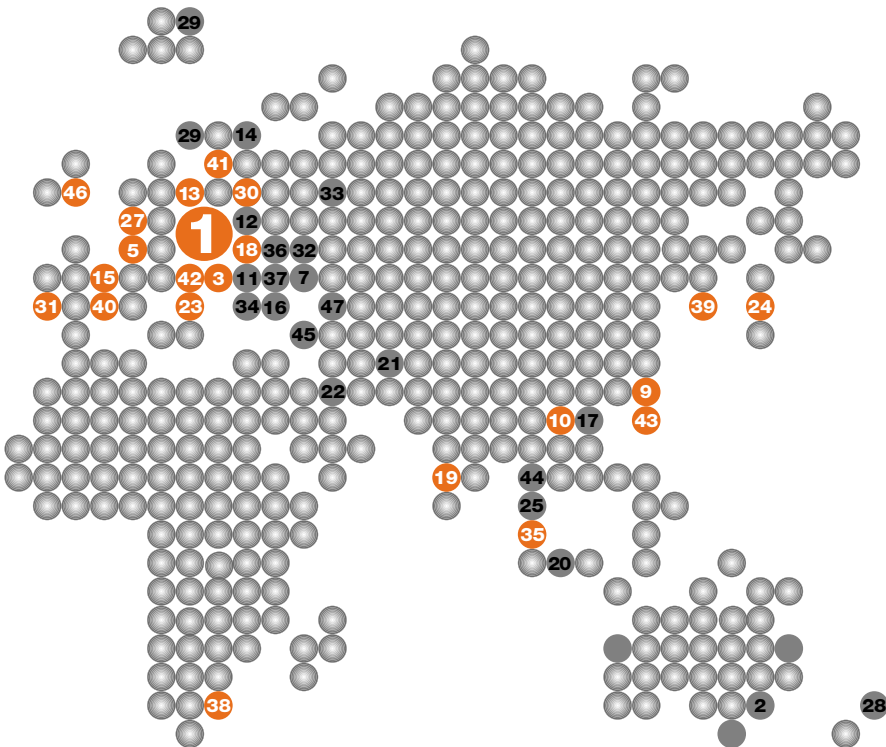

#### 26 Mexico

**igus® México S. de R.L. de C.V.**  
 Av. Tecnológico 496 Nte  
 Col. Agrícola-Bellavista  
 52149 Toluca  
 Phone +52-722-27 14 273  
 Fax +52-722-27 14 274  
 fmarquez@igus.com

#### 27 Netherlands

**igus® Nederland**  
 Sternbergweg 3  
 3769 BS Soesterberg  
 Phone +31-346-35 39 32  
 Fax +31-346-35 38 49  
 igus.nl@igus.de

#### 27 Netherlands – Bearings

**Elcee Holland BV**  
 Kamerlingh Onnesweg 28  
 NL-3316 GL Dordrecht  
 Phone +31-78-6544777  
 Fax +31-78-6544733  
 info@elcee.nl

#### 28 New Zealand

**Automation Equipment Ltd.**  
 P.O. Box 5656 Frankton  
 45 Colombo Street  
 Frankton, Hamilton  
 Phone +64-7-847 20 82  
 Fax +64-7-847 71 60  
 sales@autoequip.co.nz

#### 29 Norway / Iceland

**ASI Automatik AS**  
 Ingv. Ludvigsenstgata 23  
 3007 Drammen  
 Phone +47-32-82 92 90  
 Fax +47-32-82 92 98  
 info@asiautomatik.no

#### 30 Poland

**igus® Sp. z o.o.**  
 ul. Parowcowa 10 b  
 02-445 Warszawa  
 Phone +48-22-863 57 70  
 Fax +48-22-863 61 69  
 igus.pl@igus.com.pl

#### 31 Portugal

**igus® Lda.**  
 R. Eng. Ezequiel Campos, 239  
 4100-231 Porto  
 Phone +351-22-610 90 00  
 Fax +351-22-832 83 21  
 info@igus.pt

#### 32 Romania

**TechCon Industry SRL**  
 Calea Crangasi nr. 60  
 Bucuresti 060346  
 Phone +40-21-2219-640  
 Fax +40-21-2219-766  
 automatizar@meteor.ro

#### 32 Romania

**Hennlich S.R.L.**  
 Str. Patra, Nr17  
 310106 Arad  
 Phone +40-257-21 10 21  
 Fax +40-257-21 10 21  
 stein@hennlich.ro

#### 33 Russia

**Eka-Service Kompani**  
 1-aja Dubrowskaja, 2A, k. 35  
 109044 Moskau  
 Phone +7-495-632 66 23  
 Phone +7-812-972 49 14  
 Fax +7-495-677 17 78  
 ruspro@mail.wplius.ru

#### 34 Serbia

**Hennlich doo Beograd**  
 Ul. S. Markovica 3/4  
 11400 Mladenovac  
 Phone +381-11 39 43 414  
 Fax +381-11 39 43 412  
 office@hennlich.co.yu

#### 35 Singapore – HQ ASEAN

**igus® Singapore Pte Ltd.**  
 15 Shaw Road, #03-02  
 Singapore 367953  
 Phone +65-6487 14 11  
 Fax +65-6487 15 11  
 Malaysia-Hotline +60-12-709 30 41  
 Thailand-Hotline +66-9-160 73 69  
 asia-sales@igus.de

#### 36 Slovakia

**Hennlich Industrietechnik s.r.o.**  
 Košická 52  
 821 08 Bratislava  
 Phone +421-2-50 20 43 08  
 Fax +421-2-50 20 43 11  
 technick@hennlich.sk

#### 37 Slovenia

**Hennlich, d.o.o.**  
 Industrijska tehnika  
 Podnart 33  
 SI-4244 Podnart  
 Phone +386-4-532 06 10  
 Fax +386-4-532 06 20  
 info@hennlich.si

#### 38 South Africa

**igus® Pty. Ltd.**  
 178 Lansdowne Rd. Unit 4  
 Lansdowne Industrial Park  
 4052 Jacobs / Durban  
 Phone +27-31-461 48 24  
 Fax +27-31-461 48 25  
 admin@igus.co.za

#### 39 South Korea

**igus® Korea Co. Ltd.**  
 25BL 13LT Namdong Ind. Complex  
 446-11 Northyongdong, Namdonggu  
 Incheon City, 405-300  
 Phone +82-32-821 29 11  
 Fax +82-32-821 29 13  
 sales-korea@igus.de

#### 40 Spain

**igus® S.L.**  
 C/ Lobatona, 6  
 Poligono Noi del Sucre  
 08940 Viladecans - Barcelona  
 Phone +34-93-647 39 50  
 Fax +34-93-647 39 51  
 igus.es@igus.es

#### 41 Sweden

**igus® ab**  
 Knut Påls väg 8  
 256 69 Helsingborg  
 Phone +46-42-32 92 70  
 Fax +46-42-21 15 85  
 info@igusab.se

#### 41 Sweden – E-Chains®

**OEM Automatic AB**  
 Box 10 11, Dalagatan 4  
 673 28 Tranås  
 Phone +46-75-242 41 59  
 Fax +46-75-242 41 59  
 info@aut.oem.se

#### 41 Sweden – Bearings

incl. DryLin®  
**Colly Components AB**  
 P.O. Box 76  
 164 94 Kista  
 Phone +46-8-70 30 100  
 Fax +46-8-70 39 841  
 info@me.colly.se

#### 42 Switzerland

**igus® Schweiz GmbH**  
 Industriest. 11  
 4623 Neuendorf  
 Phone +41-62-38 89 797  
 Fax +41-62-38 89 799  
 info.ch@igus.ch

#### 43 Taiwan

**igus® Taiwan Company Limited**  
 2F, No 82, 32nd Road  
 Taichung Industrial Park  
 40768 Taichung  
 Phone +886-4-23 58-1000  
 Fax +886-4-23 58-1100  
 igus-taiwan@igus.com.tw

#### 44 Thailand

**Autoflexible Engineering Co., Ltd.**  
 Bangkai, Phakanong  
 Bangkok 10260  
 Phone +66-2-311 21 11  
 Fax +66-2-332 79 00  
 kwanchai@autoflexible.com

#### 45 Turkey

**HIDREL Hidrolik Elemanlar**  
 Sanayi ve Ticaret A.Ş.  
 Peremli Sk. No. 11-15  
 Tünel Mevki  
 80000 Karaköy / Istanbul  
 Phone +90-212-249 48 81  
 Fax +90-212-292 08 50  
 info@hidrel.com.tr

#### 46 United Kingdom

**igus® UK Ltd.**  
 51A Caswell Road  
 Brackmills  
 Northampton NN4 7PW  
 Phone +44-1604-67 72 40  
 Fax China +44-01604 67 72 42  
 Fax Bearing +44-01604 67 72 45  
 sales\_uk@igus.co.uk

#### 47 Ukraine

**Cominpro Ltd.**  
 Romania Rollaria 12, Office 220  
 61058 Kharkov  
 Phone +38-057 717 49 14  
 Fax +38-057 717 49 14  
 cominpro@gmail.com

#### 48 USA

**igus® inc.**  
 50 N. Broadway  
 P.O. Box 14349  
 East Providence, RI 02914  
 Phone +1-401-438 22 00  
 Fax +1-401-438 72 70  
 webmaster@igus.com